



# SCREWLine<sup>3</sup>

High efficiency air-cooled liquid chiller air-cooled for outdoor installation

**WDAT-SL3 200.2-580.2**



Dear Customer,

We congratulate you on choosing this product

For many years Clivet has been offering systems that provide maximum comfort, together with high reliability, efficiency, quality and safety.

The aim of the company is to offer advanced systems, that assure the best comfort, reduce energy consumption and the installation and maintenance cost for the life cycle of the system.

The purpose of this manual is to provide you with information that is useful from reception of the equipment, through installation, operational usage and finally disposal so that this advanced system offers the best solution.

Yours faithfully,

CLIVET Spa

The data contained in this manual is not binding and may be changed by the manufacturer without prior notice.

Reproduction, even in part, is FORBIDDEN © Copyright - CLIVET S.p.A. - Feltre (BL) - Italia

---

# Index of contents

1	General description	4
2	Reception	6
3	Positioning	8
4	Water connections	10
5	Electrical connections	13
6	Start-up	19
7	Control	27
8	Maintenance	33
9	Status	37
10	Accessories	42
11	Decommissioning	47
12	Residual risks	48
13	Technical information	49
14	Dimensional drawings	57

# 1 General description

## 1.1 Manual

The manual provides correct unit installation, use and maintenance.

Pay particular attention to:



Warning, identifies particularly important operations or information.



Prohibited operations that must not be carried out, that compromise the operating of the unit or may cause damage to persons or things.

- It is advisable to read it carefully so you will save time during operations.
- Follow the written indications so you will not cause damages to things and injuries people.

## 1.2 Preliminaries

Only qualified personnel can operate on the unit, as required by the regulation in force.

## 1.3 Risk situations



The unit has been designed and created to prevent injuries to people.

During designing it is not possible to plane and operate on all risk situation.

Read carefully "Residual risk" section where all situation which may cause damages to things and injuries to people are reported.

Installation, starting, maintenance and repair required specific knowledge; if they are carried out by inexperienced personnel, they may cause damages to things and injuries people.

## 1.4 Intended use

Use the unit only:

- cooling water or a water and glycol mix for air-conditioning
- keep to the limits foreseen in the technical schedule and in this manual

The manufacturer accepts no responsibility if the equipment is used for any purpose other than the intended use.

## 1.5 Installation



The positioning, hydraulic system, refrigerating, electrics and the ducting of the air must be determined by the system designer in accordance with local regulations in force.

Follow local safety regulations.

Verify that the electrical line characteristics are in compliance with data quotes on the unit serial number label.

## 1.6 Maintenance

Plan periodic inspection and maintenance in order to avoid or reduce repairing costs.



Turn the unit off before any operation.

## 1.7 Modification



All unit modifications will end the warranty coverage and the manufacturer responsibility.

## 1.8 Breakdown/Malfuction

Disable the unit immediately in case of breakdown or malfunction.

Contact a certified service agent.

Use original spares parts only.

Using the unit in case of breakdown or malfunction:

- voids the warranty
- it may compromise the safety of the unit
- may increase time and repair costs

## 1.9 User training



The installer has to train the user on:

- Start-up/shutdown
- Set points change
- Standby mode
- Maintenance
- What to do / what not to do in case of breakdown

## 1.10 Data update

Continual product improvements may imply manual data changes.

Visit manufacturer web site for updated data.

## 1.11 Indications for the User



Keep this manual with the wiring diagram in an accessible place for the operator.

Note the unit data label so you can provide them to the assistance centre in case of intervention (see “Unit identification” section).

Provide a unit notebook that allows any interventions carried out on the unit to be noted and tracked making it easier to suitably note the various interventions and aids the search for any breakdowns.

In case of breakdown or malfunction:

- Immediately deactivate the unit
- Contact a service centre authorized by the manufacturer



The installer must train the user, particularly on:

- Start-up/shutdown
- Set points change
- Standby mode
- Maintenance
- What to do / what not to do in case of breakdown

## 1.12 Unit identification

The serial number label is positioned on the unit and allows to identify all the unit features.



The matriculation plate must never be removed.

The matriculation plate shows the indications foreseen by the standards, in particular:

- unit type
- serial number (12 characters)
- year of manufacture
- wiring diagram number
- electrical data
- manufacturer logo and address

## 1.13 Serial number

It identifies uniquely each unit.

Must be quoted when ordering spare parts.

## 1.14 Assistance request

Note data from the serial number label and write them in the chart on side, so you will find them easily when needed.

Series
Size
Serial number
Year of manufacture
Electrical wiring diagram

## 2 Reception



You have to check before accepting the delivery:

- That the unit hasn't been damaged during transport
- That the materials delivered correspond with that indicated on the transport document comparing the data with the identification label positioned on the packaging.

In case of damage or anomaly:

- Write down on the transport document the damage you found and quote this sentence: "Conditional acceptance clear evidence of deficiencies/damages during transport"
- Contact by fax and registered mail with advice of receipt to supplier and the carrier.



Any disputes must be made within 8 days from the date of the delivery. Complaints after this period are invalid.

### 2.1 Storage

Observe external packaging instructions.

### 2.2 Handling

1. Verify unit weight and handling equipment lifting capacity.
2. Identify critical points during handling (disconnected routes, flights, steps, doors).
3. Suitably protect the unit to prevent damage.
4. lifting brackets
5. Lifting with balance
6. Lifting with spacer bar
7. Align the barycenter to the lifting point
8. Use all the lifting brackets (see the dimensional section)
9. Gradually bring the lifting belts under tension, making sure they are positioned correctly.
10. Before starting the handling, make sure that the unit is stable.

1



2

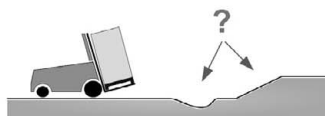

3

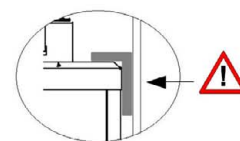

4

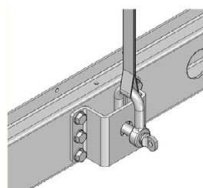

5

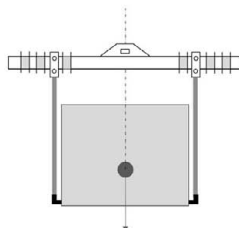

6

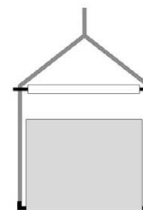

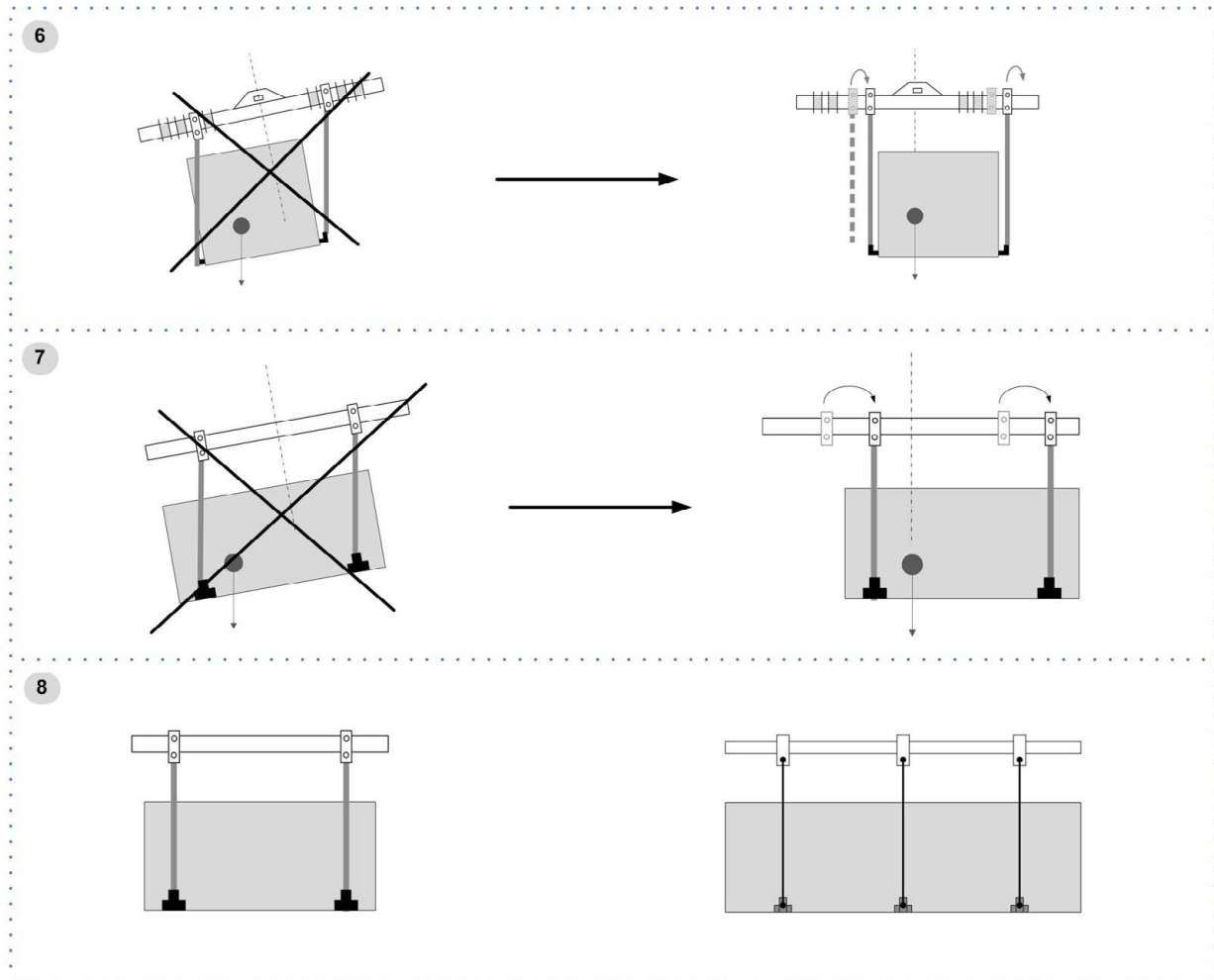

## 2.3 Packaging removing

Be careful not to damage the unit.

Keep packing material out of children's reach it may be dangerous.

Recycle and dispose of the packaging material in conformity with local regulations.

## 3 Positioning

During positioning consider these elements:

- Technical spaces requested by the unit
- Electrical connections
- Water connections
- Spaces for air exhaust and intake

### 3.1 Functional spaces

Functional spaces are designed to:

- guarantee good unit operation
- carry out maintenance operations
- protect authorized operators and exposed people

Respect all functional spaces indicated in the DIMENSIONS section.

Double all functional spaces if two or more unit are aligned.

### 3.2 Positioning



Units are designed to be installed:

- EXTERNAL
- in fixed positions

Limit vibration transmission:

- use antivibration devices on unit bearing points
- install flexible joints on the hydraulic connections

Choose the installation place according to the following criteria:

- Customer approval
- safe accessible position
- technical spaces requested by the unit
- spaces for the air intake/exhaust
- max. distance allowed by the electrical connections
- avoid flood-prone places
- verify unit weight and bearing point capacity
- verify that all bearing points are aligned and leveled
- install the unit raised from the ground
- consider the maximum possible snow level

A correct circulation of the air is mandatory to guarantee the good unit operating.

Protect the unit with suitable fence in order to avoid access to unauthorised personnel (children, vandals, etc.)



Avoid therefore:

- obstacles to the airflow
- difficulty of exchange
- leaves or other foreign bodies that can obstruct the air coil
- winds that hinder or favour the airflow
- heat or pollution sources close to the unit (chimneys, extractors etc..)
- stratification (cold air that stagnates at the bottom)
- recirculation (expelled air that is sucked in again)
- incorrect positioning, close to very high walls, attics or in angles that could give rise to stratification or recirculation phenomenons

Ignoring the previous indications could:

- reduce energy efficiency
- alarm lockout due to HIGH PRESSURE (in summer) or LOW PRESSURE (in winter)

### 3.3 Safety valve gas side

The installer is responsible for evaluating the opportunity of installing drain tubes, in conformity with the local regulations in force (EN 378).

### 3.4 Antivibration

For details see:

10.4 Anti-vibration mount support p. 45



### 3.5 AxiTop

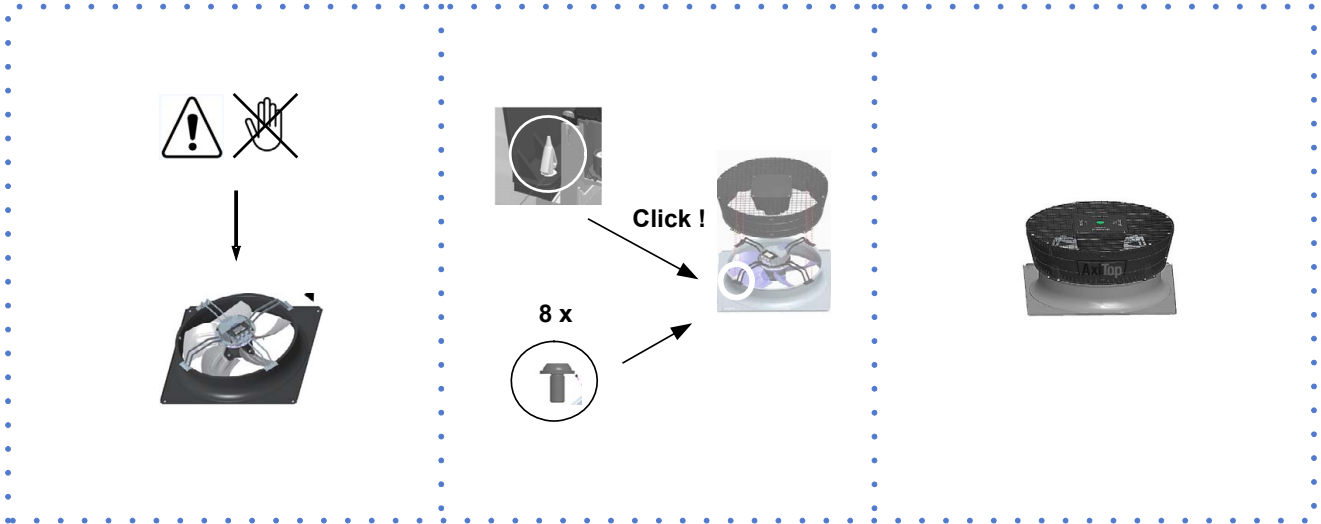

## 4 Water connections

### 4.1 Water quality

Water features

- confirming to local regulations
- total hardness < 14°fr
- within the limits indicated by table

The water quality must be checked by qualified personnel.

Water with inadequate characteristics can cause:

- pressure drop increase
- reduces energy efficiency
- increased corrosion potential

Acceptable water quality values:

ACCEPTABLE WATER QUALITY LIMITS					
PH (25°C)		<b>6.8 - 8.0</b>	Iron	mg Fe/l	<b>&lt;1.0</b>
Electrical conductivity	µS/cm 25°C	<b>&lt; 800</b>	Copper	mg Cu/l	<b>&lt;1.0</b>
Chloride ion	mg Cl <sup>-</sup> /l	<b>&lt;150</b>	Sulphide ion	S <sup>-2</sup> /l	<b>none</b>
Chlorine molecular	mg Cl <sub>2</sub> /l	<b>&lt;5</b>	Ammonium ion	mg NH <sub>4</sub> <sup>+</sup> /l	<b>&lt;1.0</b>
Sulphate ion	mg SO <sub>4</sub> <sup>-2</sup> /l	<b>&lt;100</b>	Silica	mg SiO <sub>2</sub> /l	<b>&lt;50</b>
Alkalinity (mg CaCO <sub>3</sub> /l)	mg CaCO <sub>3</sub> /l	<b>&lt;100</b>	Total dissolved solids	mg/l	<b>&lt;1500</b>
Total Hardness	mg CaCO <sub>3</sub> /l	<b>&lt;200</b>	Max Ethylene, Propylene glycol		<b>75%</b>

Provide a water treatment system if values fall outside the limits.

The warranty does not cover damages caused by limestone formations, deposits and impurities from the water supply and / or failure from failed system clearing to clean system.

### 4.2 Risk of freezing

If the unit or the relative water connections are subject to temperatures close to 0°C:

- mix water with glycol, or
- safeguard the pipes with heating cables placed under the insulation, or
- empty the system in cases of long non-use

### 4.3 Anti-freeze solution

The use of an anti-freeze solution results in an increase in pressure drop.



Make sure that the glycol type utilized is inhibited (not corrosive) and compatible with the water circuit components.



Do not use different glycol mixture (i.e. ethylene with propylene).

### 4.4 Water flow-rate

The project water-flow must be:

- inside the exchanger operating limits (see the TECHNICAL INFORMATION section)
- guarantee, also with variable system conditions (for example in systems where some circuits are bypassed in particular situations).

### 4.5 Minimum system water content

Minimum system water volumes are described within 'General technical data' section and they have to be satisfied to avoid continuous compressor switching on and off.

## 4.6 Recommended connection

- ⚠ The installer must define:
- component type
  - position in system

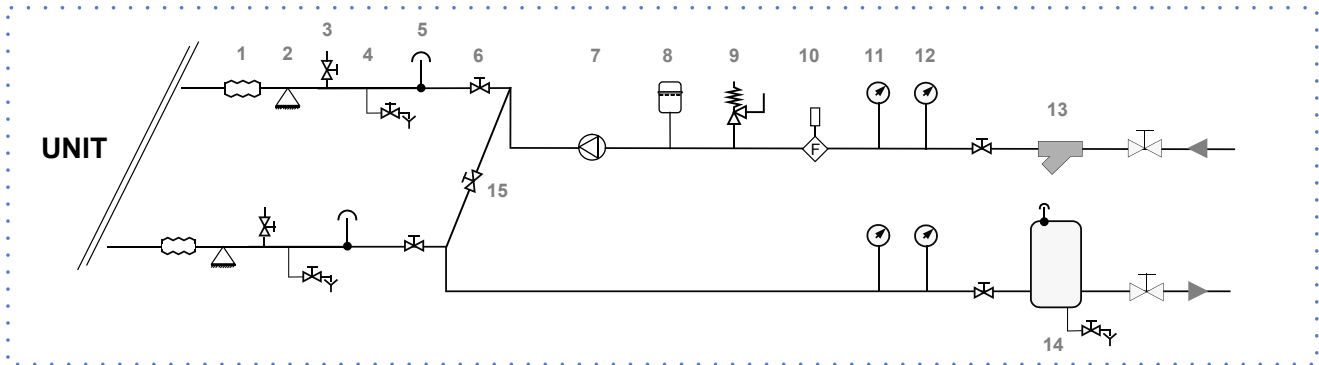

- |   |                                    |    |                        |
|---|------------------------------------|----|------------------------|
| 1 | antivibration joints               | 9  | safety valve           |
| 2 | pipng support                      | 10 | Flow Switch            |
| 3 | exchanger chemical cleaning bypass | 11 | pressure gauge         |
| 4 | drain valve                        | 12 | thermometer            |
| 5 | vent                               | 13 | filter                 |
| 6 | shut-off valve                     | 14 | Internal storage tank  |
| 7 | Pump / circulating pump            | 15 | Cleaning system bypass |
| 8 | expansion vessel                   |    |                        |

## 4.7 Hydraulic connections

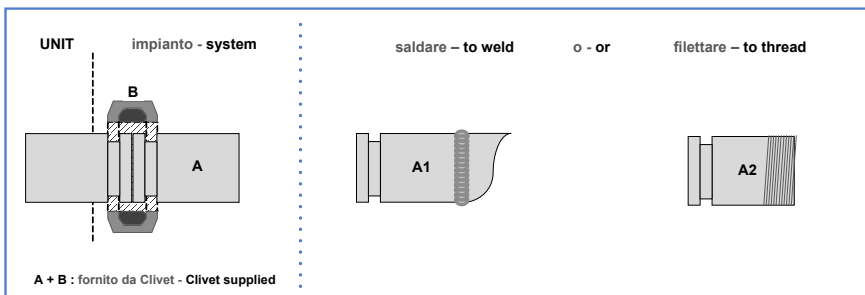

- ⊘ Remove the connection joint before welding the pipe of the installation.  
The rubber gasket might be irreparably damaged.

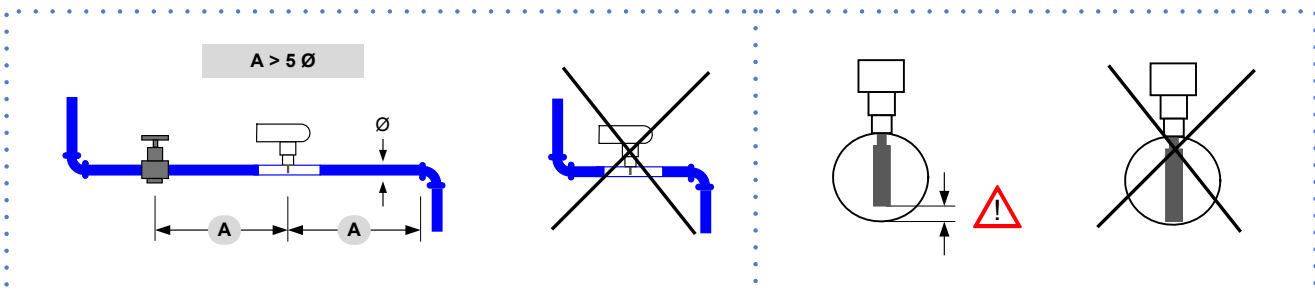

## 4.8 Flow Switch

The flow switch must be present to ensure shutdown of the unit if water is not circulating.  
It has to be installed in a duct rectilinear part, not in proximity of curves that cause turbulences.



A. minimum distance

## 4.9 Water filter

-  Use filter with mesh pitch of 1,0 mm
-  It must be installed immediately in the water input of the unit, in a position that is easily accessible for cleaning.
-  The filter never should be removed, this operation invalidates the guaranty.

## 4.10 Operation sequence

Close all vent valves in the high points of the unit hydraulic circuit

Close all drain valves in the low points of the unit hydraulic circuit:

- Heat exchangers
  - Pumps
  - collectors
  - storage tank
  - free-cooling coil
1. Carefully wash the system with clean water: fill and drain the system several times.
  2. Apply additives to prevent corrosion, fouling, formation of mud and algae.
  3. Fill the plant
  4. Execute leakage test.
  5. Isolate the pipes to avoid heat dispersions and formation of condensate.
  6. Leave various point of service free (wells, vent-holes etc).

-  Neglecting the washing will lead to several filter cleaning interventions and at worst cases can cause damages to the exchangers and the other parts.

## 4.11 Energy recovery

For details see:

10 Accessories p. 42

## 4.12 hydronic assembly

For details see:

10 Accessories p. 42

## 5 Electrical connections

The characteristics of the electrical lines must be determined by qualified electrical personnel able to design electrical installations; moreover, the lines must be in conformity with regulations in force.

The protection devices of the unit power line must be able to stop all short circuit current, the value must be determined in accordance with system features.

The power cables and the protection cable section must be defined in accordance with the characteristics of the protections adopted.

All electrical operations should be performed by trained personnel having the necessary qualifications required by the regulations in force and being informed about the risks relevant to these activities.

Operate in compliance with safety regulations in force.

### 5.1 Electrical data



The serial number label reports the unit specific electrical data, included any electrical accessories.

The electrical data indicated in the technical bulletin and in the manual refer to the standard unit, accessories excluded.

The matriculation plate shows the indications foreseen by the standards, in particular:

- Voltage
- F.L.A.: full load ampere, absorbed current at maximum admitted conditions
- F.L.I.: full load input, full load power input at max. admissible condition
- Electrical wiring diagram Nr.

### 5.2 Connections

1. Refer to the unit electrical diagram (the number of the diagram is shown on the serial number label).
2. Verify that the electrical supply has characteristics conforming to the data shown on the serial number label.
3. Before starting work, ensure the unit is isolated, unable to be turned on and a safety sign used.
4. Ensure correct earth connection.
5. Ensure cables are suitably protected.
6. Before powering up the unit, make sure that all the protections that were removed during the electrical connection work have been restored.

### 5.3 Signals / data lines

Do not exceed the maximum power allowed, which varies, according to the type of signal.

Lay the cables far from power cables or cables having a different tension and that are able to emit electromagnetic disturbances.

Do not lay the cable near devices which can generate electromagnetic interferences.

Do not lay the cables parallel to other cables, cable crossings are possible, only if laid at 90°.

Connect the screen to the ground, only if there aren't disturbances.

Guarantee the continuity of the screen during the entire extension of the cable.

Respect impedance, capacity and attenuation indications.

### 5.4 Power input

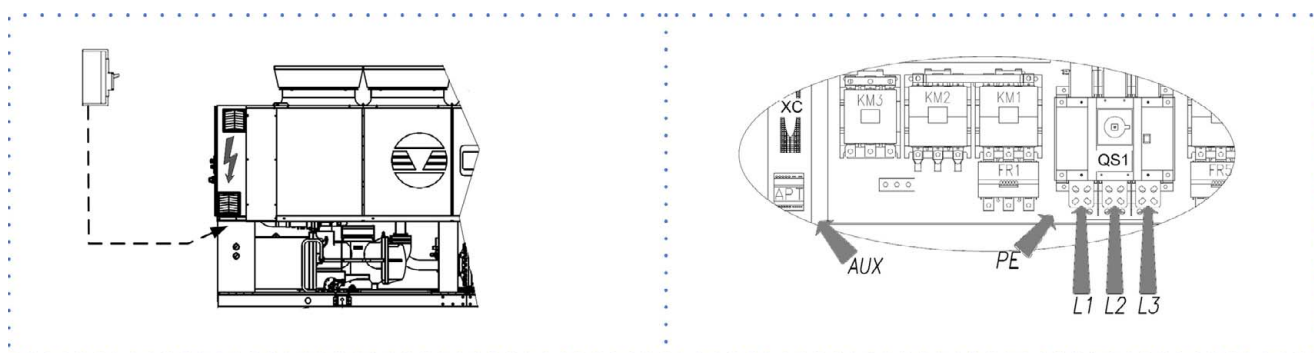

Fix the cables: if vacated may be subject to tearing.



The cable must not touch the compressor and the refrigerant piping (they reach high temperatures).

QS1: main isolator switch

XC: Customer connections

## 5.5 Power supply cables section

Size	200.2	210.2	220.2	240.2	260.2	280.2	320.2
Min. cable section Cu (mm <sup>2</sup> )	1x240	1x240	1x240	1x240	2x150	2x150	2x185
Max. cable section Cu (mm <sup>2</sup> )	1x240	1x240	1x240	1x240	2x300	2x300	2x300
Max. bar Cu width (mm)	40	40	40	40	50	50	63
Tightening torque (Nm)	20	20	20	20	20	20	-

Size	340.2	360.5	400.2	440.2	500.2	540.2	580.2
Min. cable section Cu (mm <sup>2</sup> )	2x185	2x185	2x240	2x240	-	-	-
Max. cable section Cu (mm <sup>2</sup> )	2x300	2x300	4x185	4x185	4x185	4x185	4x185
Max. bar Cu width (mm)	63	63	63	63	63	63	63
Tightening torque (Nm)	-	-	-	-	-	-	-

## 5.6 Connections performer by customer

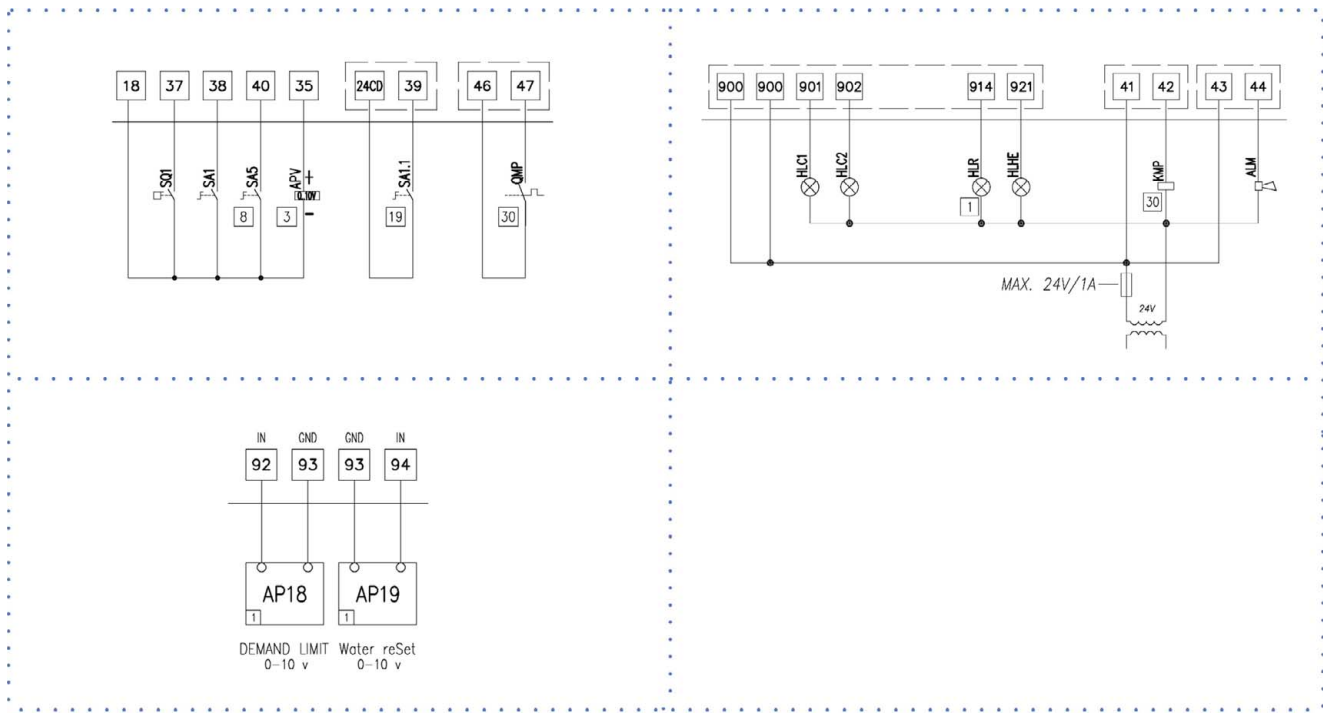

APV 0..10V analogical output  
 AP18 Demand limit  
 AP19 water reset  
 ALM cumulative fault signal  
 HLC1-2 compressor status signal  
 HLR alarm signal lamp electrical heater electrical panel selector  
 KMP evaporator pump contactor

QMP ricirculation pump  
 SA1 remote on/off  
 SA1.1 second setpoint  
 SA2.1 compressor enabling  
 SA3.1 compressor enabling  
 SQ1 Flow Switch

## 5.7 Remote ON-OFF

- ⊘ Do not perform short On Off cycles
- ⊘ Do not use the remote On Off with thermoregulation function.

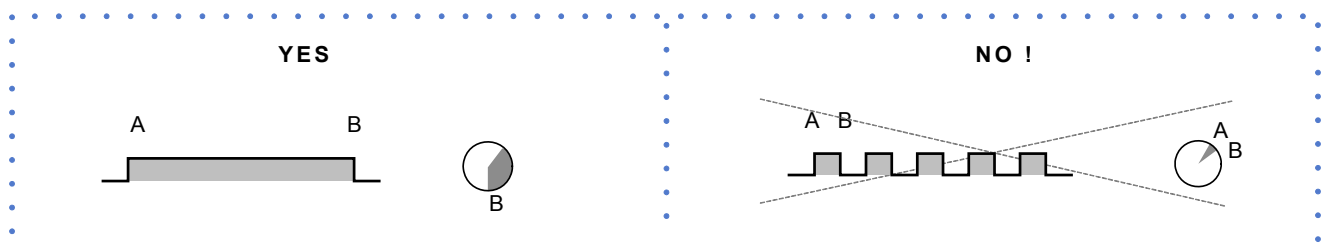

## 5.8 Computer connection

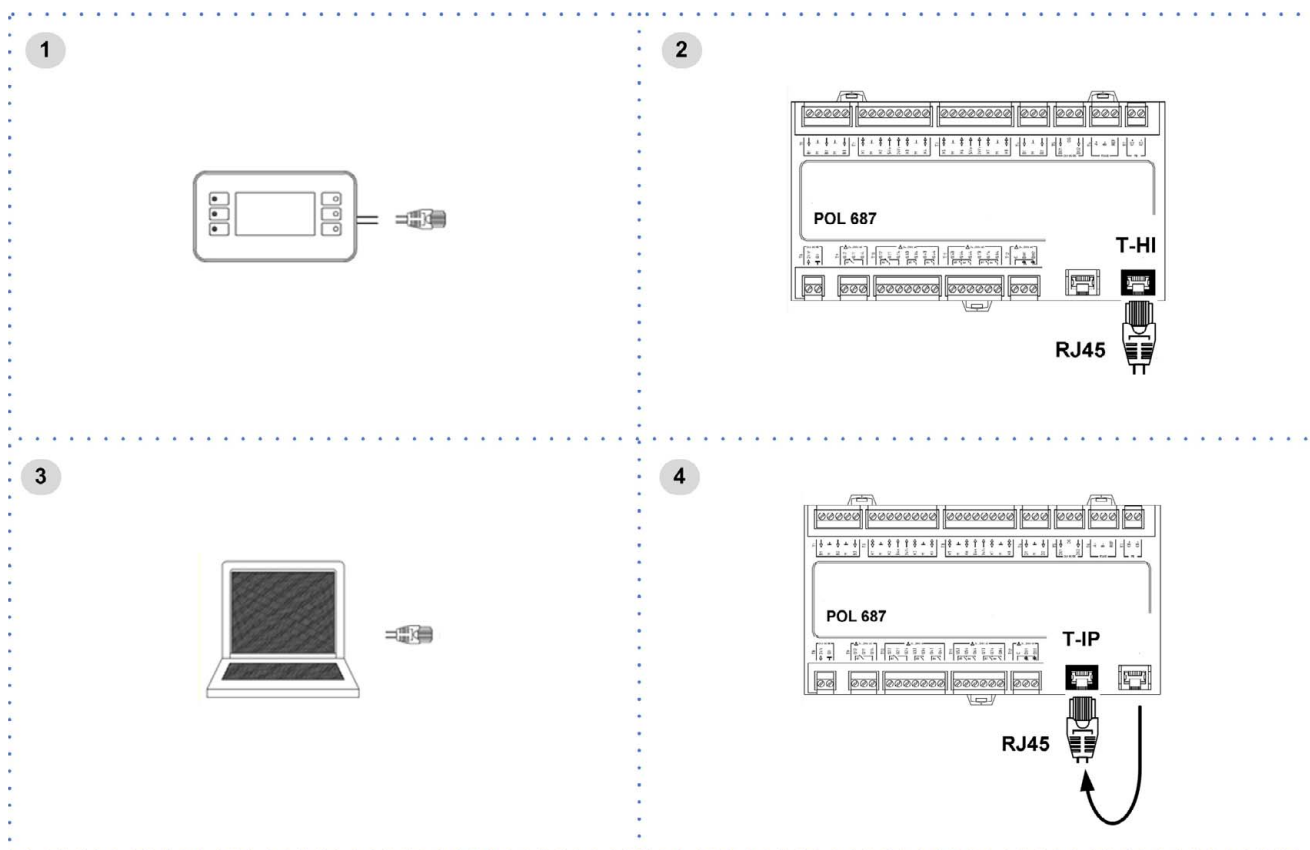

1. Service keypad
2. RJ45: standard connection
3. P.C.-not supplied
4. P.C. connection, shift RJ45 from T-HI to T-IP

### Configure P.C.

1. connect P.C. and main module with LAN cable
2. check in the taskbar that the connection is active
3. open Control Panel and select Network and sharing center
4. select Modify board setting
5. select Local area connection (LAN)
6. select Internet protocol version 4 (TCP) IPV4 and enter Property
7. set the IP address 192.168.1.100
8. set Subnet mask as 255.255.255.0
9. confirm (OK)
10. enter Start (Windows button)
11. write the command cmd and enter/do it
12. write and run the command Ping 192.168.1.42
13. the message, connection is OK, will appear when successful
14. enter the browser (Chrome, Firefox ecc)
15. write and run the command http://192.168.1.42
16. Userid = WEB
17. Password = SBTAdmin!

## 5.9 Remote control

Option

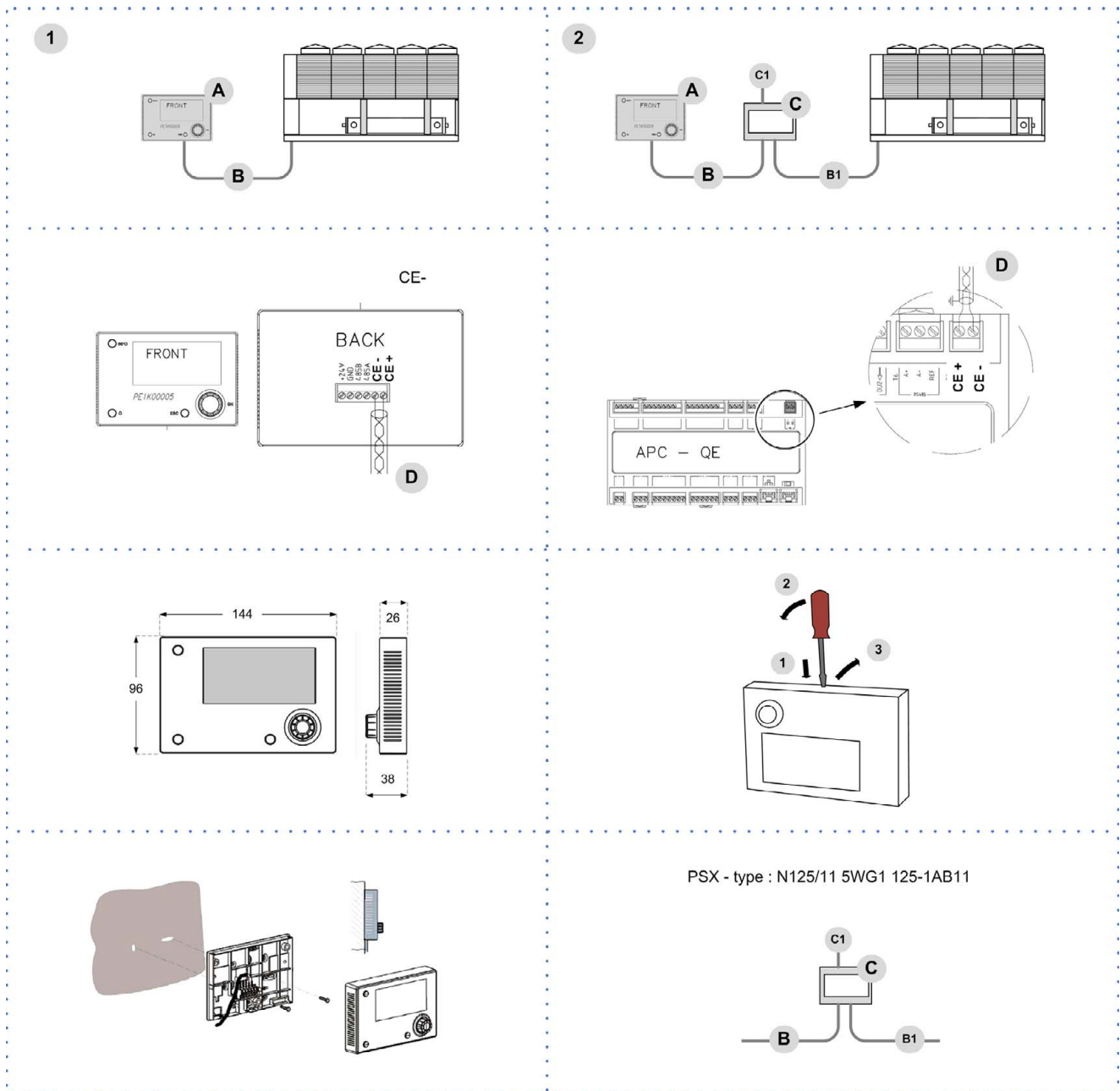

- 1 Distance up to 350 mt
- 2 Distance up to 700 mt

- A User interface
- B = B1 KNX bus, max 350 mt  
twisted pair with shield,  $\varnothing$  0,8 mm  
EIB/KNX cable marking recommende
- C PSX - Mains power supply unit  
pwer supply unit N125/11 5WG1 125-1AB11
- C1 AC 120...230V, 50...60Hz
- D KNX bus, max 350 mt



## 5.10 Modbus - RS485

Option

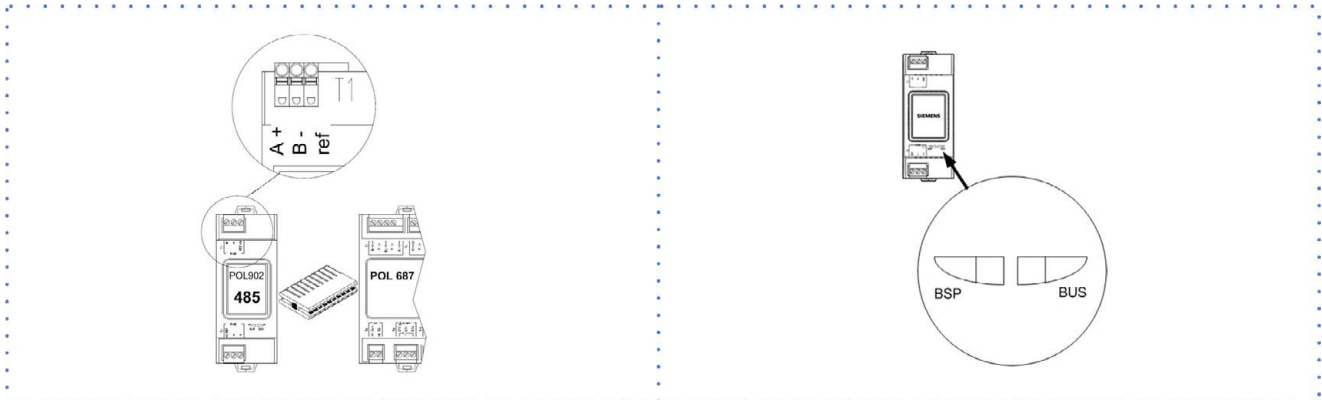

LED BSP  
green communication with AP1 module  
yellow communication ok  
red flashing: software error  
fixed: hardware error

LED BUS  
green communication ok  
yellow startup / channel not communicating  
red communication down

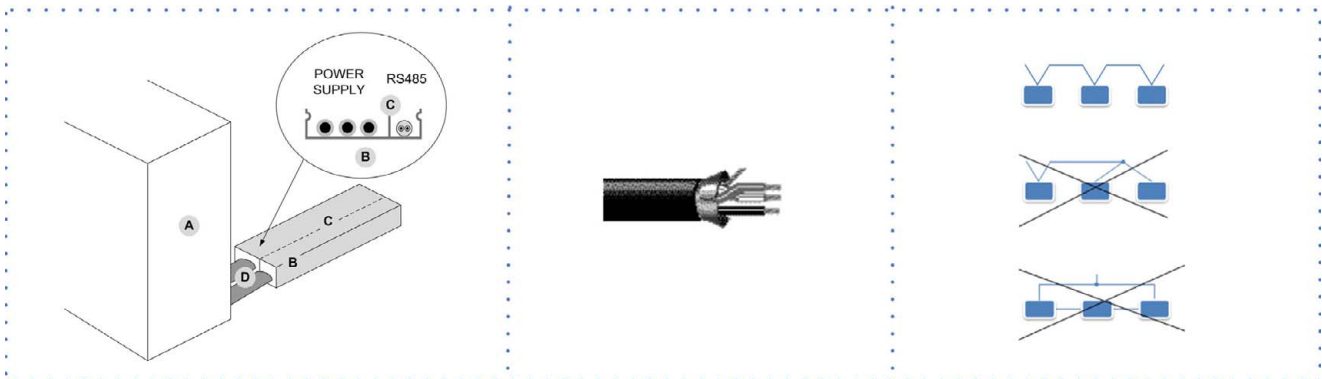

- A. Unit
- B. Metal conduit
- C. Metal septums
- D. Metal-lined sheath (sleeve)

### Modbus / LonWorks / Cable requirements

Couple of conductors twisted and shielded

Section of conductor 0,22mm<sup>2</sup>...0,35mm<sup>2</sup>

Nominal capacity between conductors < 50 pF/m

Nominal impedance 120 Ω

Recommended cable BELDEN 3106A

- Every RS485 serial line must be set up using the 'In/Out' bus system.
- Other types of networks are not allowed, such as Star or Ring networks.
- The difference in potential between the earth of the two RS485 devices that the cable shielding needs to be connected to must be lower than 7 V
- There must be suitable arresters to protect the serial lines from the effects of atmospheric discharges
- A 120 ohm resistance must be located on the end of the serial line. Alternatively, when the last serial board is equipped with an internal terminator, it must be enabled using the specific jumper, dip switch or link.
- The cable must have insulation features and non-flame propagation in accordance with applicable regulations.
- The RS485 serial line must be kept as far away as possible from sources of electromagnetic interference.

## 5.11 LonWorks

Option

**LonWorks**

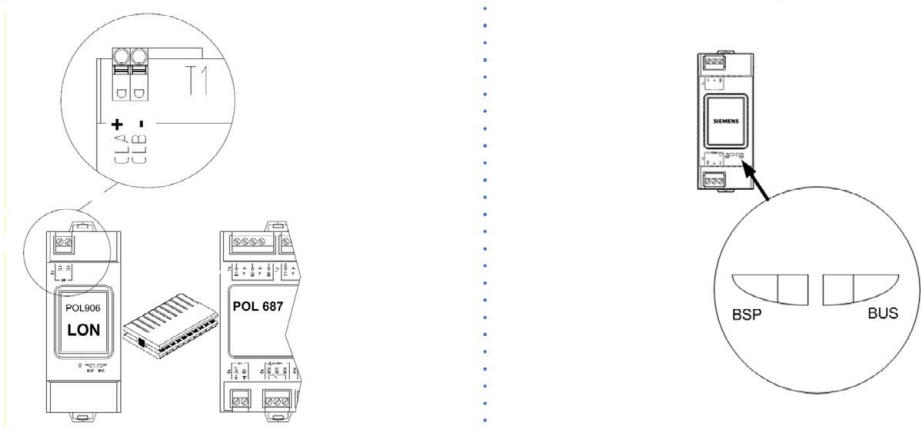

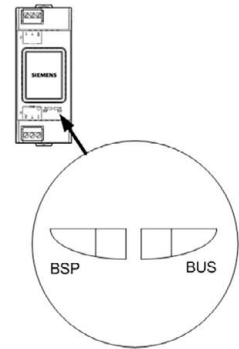

**LONWORK CABLE TYPE**  
Echelon allows three cable types for channel type TP/FT-10, including the Category 5 network cable used commonly in building automation and control (TIA 568A Cat-5).

**CAT-5 SPECIFICATIONS**  
Unshielded cable, twisted pair with at least 18 beats per meter:

- Cross-sectional area Min.  $\varnothing$  0.5mm, AWG24, 0.22mm<sup>2</sup>
- Impedance 100 +/- 15% @ f > 1 MHz
- Operating capacity between two wires of a pair < 46 nF/km
- Capacity pair to ground, asymmetric. < 3.3 nF/km
- DC loop resistance < 168  $\Omega$

LED BSP	communication with AP1 module
green	communication ok
yellow	software ok but communication with AP1 down
red	flashing: software error
	fixed: hardware error

LED BUS	communication with LonWorks
green	ready for communication
yellow	startup
red	flashing: communicating not possible
	communication down

## 5.12 BACnet IP

Option

**BACnet**

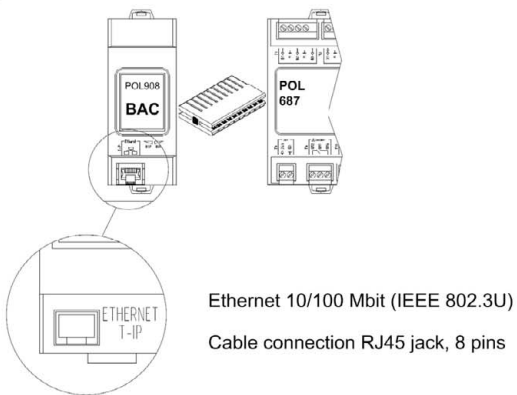

Ethernet 10/100 Mbit (IEEE 802.3U)  
Cable connection RJ45 jack, 8 pins

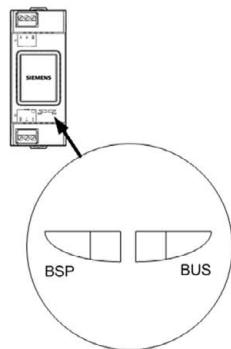

LED BSP	communication with AP1 module
green	communication ok
yellow	software ok but communication with AP1 down
red	flashing: software error
	fixed: hardware error

LED BUS	communication with BACnet
green	ready for communication
yellow	startup
red	BACnet server down
	restart after 3 sec

## 6 Start-up

### 6.1 General description

The indicated operations should be done by qualified technician with specific training on the product.

Upon request, the service centres performing the start-up.

The electrical, water connections and the other system works are by the installer.

Agree upon in advance the start-up data with the service centre.

Before checking, please verify the following:

- the unit should be installed properly and in conformity with this manual
- the electrical power supply line should be isolated at the beginning
- the unit isolator is open, locked and equipped with the suitable warning
- make sure no tension is present



After turning off the power, wait at least 5 minutes before accessing to the electrical panel or any other electrical component.



Before accessing check with a multimeter that there are no residual stresses.

### 6.2 Preliminary checks

For details refer to the different manual sections.

#### Unit OFF power supply

1. safety access
2. functional spaces
3. air flow: correct return and supply (no bypass, no stratification)
4. structure integrity
5. fans run freely
6. unit on vibration isolators
7. unit input water filter + shut-off valves for cleaning
8. vibration isolators on water connections
9. expansion tank (indicative volume = 5% system content)
10. Close all drain valves in the low points of the unit hydraulic circuit:
11. cleaned system
12. loaded system + possible glycol solution + corrosion inhibitor
13. system under pressure
14. vented system
15. fresh air probe
16. refrigerant circuit visual check
17. earthing connection
18. power supply features
19. electrical connections provided by the customer

### 6.3 Start-up sequence

For details refer to the different manual sections.

#### Unit ON power supply

1. compressor crankcase heaters operating at least since 8 hours
2. off-load voltage measure
3. phase sequence check
4. pump manual start-up and flow check
5. shut-off valve refrigerant circuit open
6. unit ON
7. load voltage measure and absorptions
8. liquid sight glass check (no bubbles)
9. check all fan operating
10. measure return and supply water temperature
11. measure super-heating and sub-cooling
12. check no anomalous vibrations are present
13. climatic curve personalization
14. climatic curve personalization
15. scheduling personalization
16. complete and available unit documentation

## 6.4 Refrigeration circuit

1. Check carefully the refrigerating circuit: the presence of oil stains can mean leakage caused by transportation, movements or other).
2. Verify that the refrigerating circuit is in pressure: Using the unit manometers, if present, or service manometers.
3. Make sure that all the service outlets are closed with proper caps; if caps are not present a leak of refrigerant can be possible.
4. Open the valves of the refrigerant circuit, if there are any.

## 6.5 Water circuit

1. Before realizing the unit connection make sure that the hydraulic system has been cleaned up and the cleaning water has been drained.
2. Check that the water circuit has been filled and pressurized.
3. Check that the shut-off valves in the circuit are in the "OPEN" position.
4. Check that there isn't air in the circuit, if required, evacuate it using the air bleed valve placed in the system high points.
5. When using antifreeze solutions, make sure the glycol percentage is suitable for the type of use envisaged.

Weight of glycol (%)	10	20	30	40
Freezing temperature (°C)	-3.9	-8.9	-15.6	-23.4
Safety temperature (°C)	-1	-4	-10	-19

## 6.6 Electric Circuit



Verify that the unit is connected to the ground plant.

Check the conductors are tightened as: the vibrations caused by handling and transport might cause these to come loose.

Connect the unit by closing the sectioning device, but leave it on OFF.

Check the voltage and line frequency values which must be within the limits: 400/3/50 +/- 10%

Check and adjust the phase balance as necessary: it must be lower than 2%

Example

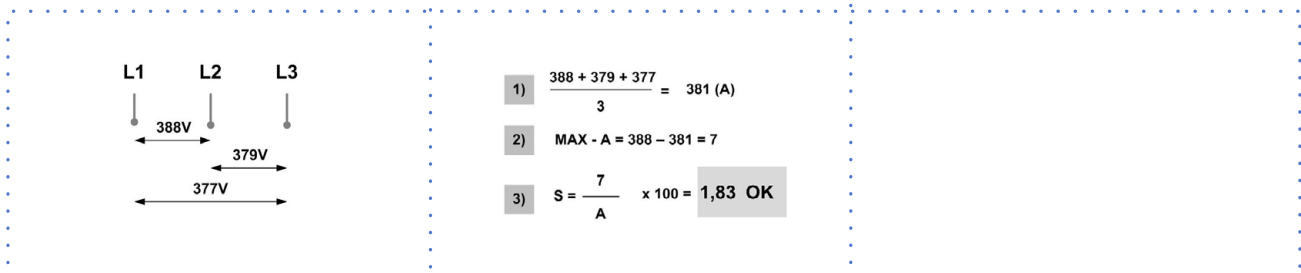

Working outside of these limits can cause irreversible damages and voids the warranty.

## 6.7 Compressor crankcase heaters

Connect the oil resistances on the compressor crankcase at least 8 hours before the compressor is to be started:

- at the first unit start-up
  - after each prolonged period of inactivity
1. Supply the resistances switching off the unit isolator switch.
  2. To make sure that heaters are working, check the power input.
  3. At start-up the compressor crank-case temperature on the lower side must be higher at least of 10°C than the outside temperature.



Do not start the compressor with the crankcase oil below operating temperature.

## 6.8 Voltages

Check that the air and water temperatures are within in the operating limits.

Start-up the unit.

With unit operating in stable conditions, check:

- Voltage
- Total absorption of the unit
- Absorption of the single electric loads

## 6.9 Remote controls

Check that the remote controls (ON-OFF etc) are connected and, if necessary, enabled with the respective parameters as indicated in the “electrical connections” section.

Check that probes and optional components are connected and enabled with the respective parameters (“electrical connections” section and following pages).

## 6.10 Demand limit

Menu accessible only after having entered the password.

Access reserved only to specifically trained personnel.

The parameter modification can cause irreversible damages.

It is possible to limit the absorbed electric power with an external signal 0-10 Vcc or 4-20mA.

The higher the signal is, the lower the number of compressors available to meet the thermal need.

Only if P0050:En DemandLimit  $\neq$  0

Path: Main Menu / Unit parameters / Demand limit

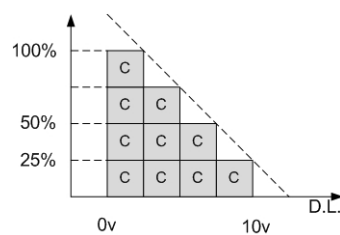

Step	Display	Action	Menu/Variable	Keys		Notes
1		Press 3 sec.				
2	Password	Set	Password			
3		Press				
4	Main menu	Select	Unit parameters			
5	Unit parameters	Select	Set Point			
6	Set Point	Select	Demand limit			
7		Set	Demand limit			
8		Confirm				
9		Press 3 sec.				
10		Select	Local connections			

Path: Main Menu / Unit parameters / Demand limit

Parameters	Short description	Description
P0009:	set demand limit	Parameter setting of the value % of demand limit
P0062	TypeDL	Inlet signal type: 0=0-10V; 1=4-20mA

## 6.11 Climatic TExt

- Menu accessible only after having entered the password.
  - Access reserved only to specifically trained personnel.
  - The parameter modification can cause irreversible damages.
- The setpoint defined by the temperature curve is shown at status S0010: ActualSptTExt  
 Only if P0053: En Climatica ≠ 0  
 Path: Main Menu / Unit parameters / Climatica TExt

Example

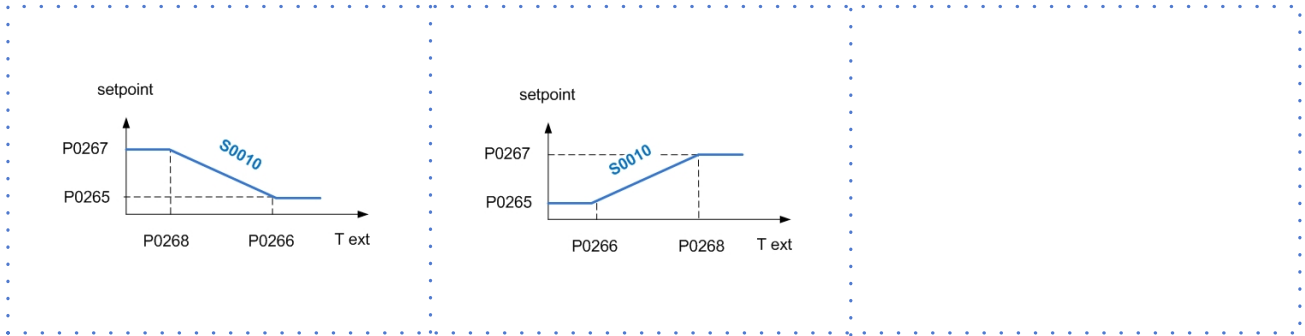

Step	Display	Action	Menu/Variable	Keys		Notes
1		Press 3 sec.				
2	Password	Set	Password			
3		Press				
4	Main menu	Select	Unit parameters			
5	Unit parameters	Select	Climatic TExt			
6	Climatic TExt (pwd)	Select	Parameter			
7		Set				
8		Confirm				
9		Press 3 sec.				
10		Select	Local connections			

Path: Main Menu / Unit parameters / Climatica TExt

Parameters	Short description	Description
P0265:	CSptLow	setpoint temperature value when the air temperature value is AirAtSptLowC
P0266:	AirAtSptLowC	external air temperature value where the calculated setpoint takes on the value given by SptLowC
P0267:	CSptHigh	setpoint temperature value when the air temperature value is AirAtSptHigC
P0268:	AirAtSptHigC	external air temperature value where the calculated setpoint takes on the value given by SptHigC

## 6.12 Water reset

- Menu accessible only after having entered the password.
- Access reserved only to specifically trained personnel.
- The parameter modification can cause irreversible damages.  
It is possible to limit the absorbed electric power with an external signal 0-10 Vcc or 4-20mA.  
The water reset correction affects the setpoint defined by the Climate curve TExt (actual setpoint).  
The setpoint is shown at status S0011: ActualSptWR  
Only if P0051: En WaterReset  $\neq$  0  
Path: Main Menu / Unit parameters / Water reset

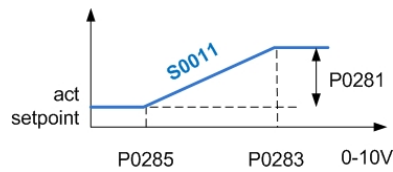

Step	Display	Action	Menu/Variable	Keys		Notes
1		Press 3 sec.				
2	Password	Set	Password			
3		Press				
4	Main menu	Select	Unit parameters			
5	Unit parameters	Select	Water reset			
6	Water reset	Select	Parameter			
7		Set				
8		Confirm				
9		Press 3 sec.				
10		Select	Local connections			

Path: Main Menu / Unit parameters / Water reset

Parameters	Short description	Description
P0063	TypeWR	Inlet signal type: 0=0-10V; 1=4-20mA
P0281:	MaxCWRC	Maximum correction to be applied to the setpoint
P0283:	SWRMaxC	Value of the WR control signal corresponding to the correction of the set COOL equal to the parameter P0281
P0285	SWRMinC	Value of the WR control signal corresponding to the correction of the set COOL equal to 0

### 6.13 ECOSHARE function for the automatic management of a group of units

- Max 7 units
- Maximum length of the bus line: 1000 m.
- Maximum distance between 2 units: 700 m.
- Type of cable: shielded twisted pair cable Ø 0,8 mm. use an EIB/KNX cable
- Possible connections: Tree, star, in/out bus, mixed
- It is not possible to use a ring connection
- No end-of-line resistor or terminator required
- There must be suitable arresters to protect the serial lines from the effects of atmospheric discharges
- The data line must be kept separate from the power conductors or powered at different voltage values and away from possible sources of electrical interference

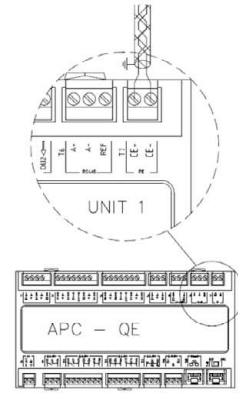
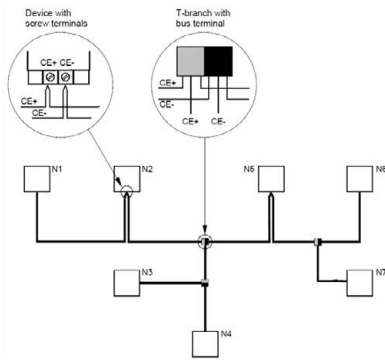

Tree topology (with stub lines)

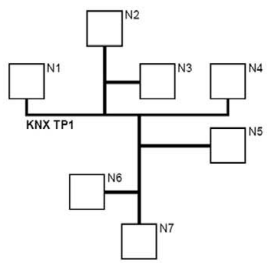

Line topology (with loops)

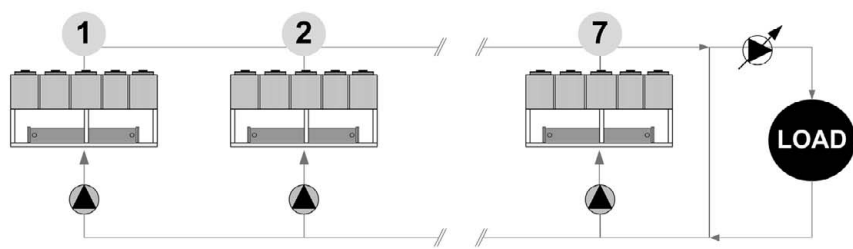
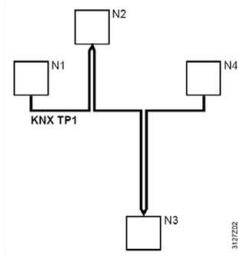



If there are more units connected in a local network set the mode of operation.

### MODE A

Every unit manages its own compressors according to the setpoint.

Every unit optimizes its refrigeration circuits.

Pumps always active, even with compressor stoped.

P0343 = 0

P0344 > 0 °C

setpoint1 > setpoint2 > setpoint3

or

setpoint1 < setpoint2 < setpoint3

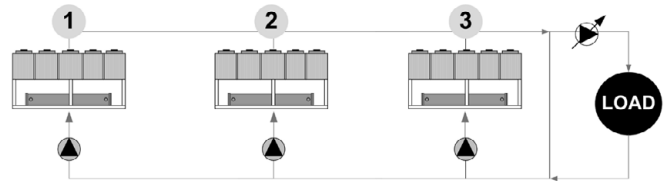

### MODE B

The master manages the single cooling.

The master optimizes individual refrigerant circuits.

Pumps always active, even with compressor stoped.

P0343 = 1

P0344 = 0 °C

setpoint1 = setpoint2 = setpoint3

plus: optimal H2O temperature control

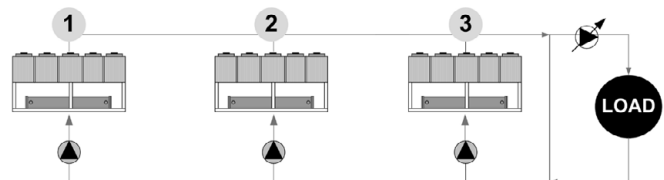

### MODE C

The master manages the single cooling.

The master optimizes individual refrigerant circuits.

Active pumps only with active compressors.

P0343 = 2

P0344 = 0 °C

setpoint1 = setpoint2 = setpoint3

plus: minimum pumps consumption need balanced system (t1 = t2 = t3)

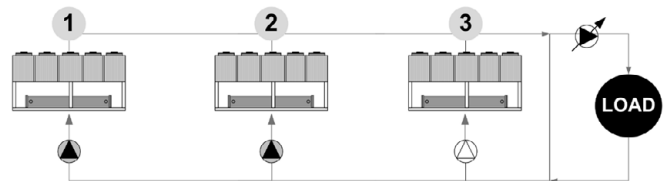

Path: Main Menu / Unit parameters / Master Slave

Parameters	Short description	Description
P0340:	Address unit	ProcessBus address unit
P0341:	Unit network	Number of network-connected units including the master
P0342:	Standby unit	Number of units kept in standby
P0343:	TypeRegMS	Operation mode: 0=mode A; 1=mode B; 2=mode C
P0344:	Offset Trm MS	Temperature Offset the master sum or subtract, depending on the way you set, in order of priority, to the set point of the slave

## 6.14 Evaporator water flow-rate

Check that the difference between the temperature of exchanger return and supply water corresponds to power according to this formula:

unit cooling power (kW) x 860 = Dt (°C) x flow rate (L/h)

The cooling power is shown in the table of the GENERAL TECHNICAL DATA included in this manual, referred to specific conditions, or in the tables on COOLING PERFORMANCE in the TECHNICAL BULLETIN referred to various conditions of use.

Check for water side exchanger pressure drops:

determine the water flow rate

measure the difference in pressure between exchanger input and output and compare it with the graph on WATER SIDE EXCHANGER PRESSURE DROPS

The measurement of pressure will be easier if pressure gauges are installed as indicated in the DIAGRAM OF SUGGESTED WATER CONNECTIONS.

## 6.15 Start-up report

Identifying the operating objective conditions is useful to control the unit over time.

With unit at steady state, i.e. in stable and close-to-work conditions, identify the following data:

- total voltages and absorptions with unit at full load
- absorptions of the different electric loads (compressors, fans, pumps etc)
- temperatures and flows of the different fluids (water, air) both in input and in output from the unit
- temperature and pressures on the characteristic points of the refrigerating circuit (compressor discharge, liquid, intake)

The measurements must be kept and made available during maintenance interventions.

## 6.16 Operating at reduced load

The units are equipped with partialization steps and they can, therefore, operate with reduced loads.

However a constant and long operation with reduced load with frequent stop and start-up of the compressor/s can cause serious damages for the lack of oil return.

The above-described operating conditions must be considered outside the operating limits.

In the event of compressor breakdown, due to operating in the above-mentioned conditions, the guarantee will not be valid and Clivet spa declines any responsibility.

Check periodically the average operating times and the frequency of the compressors starts: approximately the minimum thermal load should be such as to need the operating of a compressor for at least ten minutes.

If the average times are close to this limit, take the proper corrective actions.

## 6.17 2014/68/UE PED directive

DIRECTIVE 2014/68/UE PED gives instructions for installers, users and maintenance technicians as well.

Refer to local regulations; briefly and as an example, see the following:

Compulsory verification of the first installation:

- only for units assembled on the installer's building site (for ex. Condensing circuit + direct expansion unit)

Certification of setting in service:

- for all the units

Periodical verifications:

- to be executed with the frequency indicated by the Manufacturer (see the "maintenance inspections" paragraph)

## 7 Control

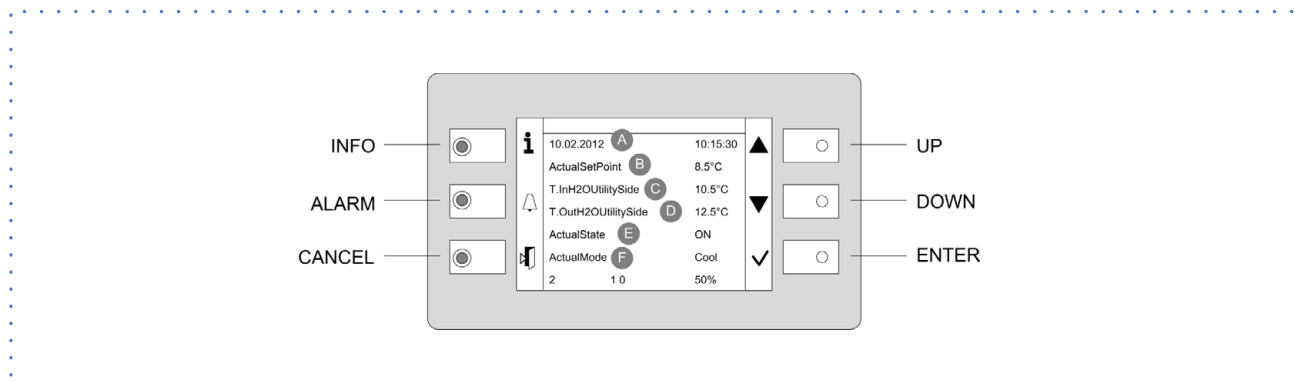

### 7.1 Led

INFO	Not used
ALARM	Blink / fixed = alarm present
CANCEL	not used currently

### 7.2 Display

Ref.	Variable	Description
A		Date - Time
B	<b>ActualSetPoint</b>	Temperature setting
C	<b>T.InH2OUtilitySide</b>	Water inlet temperature utility side
D	<b>T.OutH2OUtilitySide</b>	Water outlet temperature utility side
E	<b>ActualState</b>	On / off / eco / pmp On
F	<b>ActualMode</b>	Cool: water cooling Heat: Heating (not used)
	2	Installed compressors
	1 - 0	Compressors ON example: circuit 1 = 1 compr. On circuit 2 = 0 compr. On
	50%	Heating capacity

### 7.3 Keys

Symbol	Name	Description
	Info	Main menu
	Alarm	Alarm display
	Cancel	Exit Previous level Keyboard settings
	Up	Increases value
	Down	Decreases value
	Enter	Confirm Password

## 7.4 Change unit state

Step	Display	Action	Menu/Variable	Keys		Notes
1		Press				
2	Main menu	Select	Cmd Local state			
3		Set	OFF - ECO - ON - Pump On			*
4		Confirm				
6		Exit				

\* Local state

ECO: recurrent pump ON-OFF; compressors keep water system at setpoint ECO

Pmp ON: pump ON, compressor OFF

## 7.5 Change the mode







Step	Display	Action	Menu/Variable	Keys		Notes
1		Press				
2	Main menu	Select	Cmd Local mode			
3		Set	Cool: water cooling Heat: water heating (option)			
4		Confirm				
5		Exit				

## 7.6 Modify setpoint

Step	Display	Action	Menu/Variable	Keys		Notes
1		Press				
2	Main menu	Select	Unit parameters			
3	Unit parameters	Confirm	Set Point			
4		Select	Set Point			
5		Set	Set Point			
6		Confirm				
7		Exit				

Parameters	Short description	Description	
P0001	SetPoint Cool	Setpoint Cool	
P0002	SetPoint Heat	Setpoint Heat	Not used
P0003	2°SetPoint Cool	2° Setpoint Cool	Enable by remote switch
P0004	2°SetPoint Heat	2° Setpoint Heat	not used currently
P0005	SetPoint ECOCool	Economic summer SetPoint	
P0006	SetPoint ECOHeat	Economic winter SetPoint	Not used
P0007	SetPointRec	Recovery Set Point	

















## 7.7 Display the status

Step	Display	Action	Menu/Variable	Keys		Notes
1		Press				
2	Main menu	Select	Machine State			
3		Select	General, circuit, ecc..			
4		Exit				













For details see:  
9 Status p. 37

## 7.8 Scheduler

It is possible to set 6 events (Off, Eco, On, Recirculating) for each week day.

Step	Display	Action	Menu/Variable	Keys		Notes
1		Press				
2	Main menu	Select	Scheduler			
3	Scheduler	Select	Day			
4		Select	Time			
5		Set	Event time			
6		Confirm				
7		Select	Value			
8		Set	On/Eco..			
9		Confirm				
10		Exit				

### Enable Scheduler

Step	Display	Action	Menu/Variable	Keys		Notes
1		Press 3 sec.				
2	Password	Set	Password			
3		Press				*
4	Main menu	Select	Unit Parameters			
5		Select	Option config			
6		Set	P0061=1			
7		Press 3 sec.				
		Select	Local connections			

\* Unit Parameters menu is displayed

## 7.9 Alarms



Before resetting an alarm identify and remove its cause.

Repeated resets can cause irreversible damage.

Example:

+ eE001: Monitore fase: Fault = active alarm

- EE003: Guasto P1 Util: Ok = resetted alarm

Display of alarm: step 1-3

Reset allarm: step 4-10

Step	Display	Action	Menu/Variable	Keys		Notes
1		Press				
2	Alarm list detail	Press				
3	Alarm list	Select	Alarm			
4	Alarm list detail	Press 3 sec.				
5	Password	Set	Enter password			
6	Alarm list detail	Press				
7	Alarm list	Select	Alarm			
8		Select	Reset Executed			
9		Press 3 sec.				
10	Password management	Select	Log off			

## 7.10 Keyboard settings

Step	Display	Action	Menu/Variable	Keys		Notes
1		Press 3 sec.				
2		Press				
3	HMI Settings	Select				
4		Press				
5		Press				
6		Select	Local connections			

## 7.11 General list of alarms

The alarm code identifies the concerned circuit:

Example:

ee 1 01:TimeOutModCirc = circuit 1

ee 2 01:TimeOutModCirc = circuit 2

The number of refrigerant circuits depends on series and size of the unit.

### t.i. input type:

DI = digital input

AI = analogic input

### Module:

687 = main module

985 = circuit module

94U = thermostatic driver module

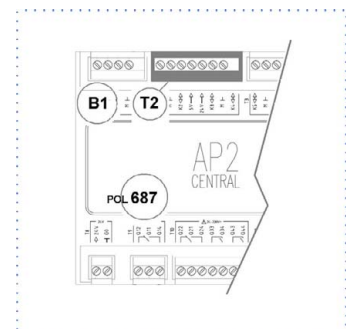

**Input:**

Connector number:

T1, T2, T3.....

PIN code:

X1, X2, Q13, DO1.....

**t.a. alarm type:**

A automatic reset

M manual reset

A/M automatic reset, (after N alarm interventions becomes manual reset)

code	detailed description	t.i.	module	input	t.a.
eE001	Phase monitor	DI	687 central	T13 DL1	A/M
EE003	Pump 1 overload	DI	687 central	T13 DL2	M
EE004	Pump 2 overload	DI	687 central	T4 D1	M
EE005	Pump 3 overload	DI	687 central	T13 DL2	M
ee010	Master Offline - Master Slave network enabled				A
ee011	Unit 2 in alarm - Master Slave network enabled				A
ee012	Unit 2 OffLine - Master Slave network enabled				A
ee013	Unit 3 in alarm - Master Slave network enabled				A
ee014	Unit 3 OffLine - Master Slave network enabled				A
ee015	Unit 4 in alarm - Master Slave network enabled				A
ee016	Unit 4 OffLine - Master Slave network enabled				A
ee017	Unit 5 in alarm - Master Slave network enabled				A
ee018	Unit 5 OffLine - Master Slave network enabled				A
ee019	Unit 6 in alarm - Master Slave network enabled				A
ee020	Unit 6 OffLine - Master Slave network enabled				A
ee021	Unit 7 in alarm - Master Slave network enabled				A
ee022	Unit 7 OffLine - Master Slave network enabled				A
EE023	Pump 1 thermal protection	DI	965 hydronic	T1 X4	M
EE024	Pump 2 thermal protection	DI	965 hydronic	T1 X5	M
EE025	Pump 3 thermal protection	DI	965 hydronic	T1 X6	A
EE026	Inverter thermal protection	DI	965 hydronic	T5 DL1	A
ee027	Water inlet temperature probe faulty	AI	687 central	T1 B1	A
ee028	Water outlet temperature probe faulty	AI	687 central	T1 B2	A
ee029	External air temperature probe faulty	AI	687 central	T1 B3	A
ee030	Signal logoff or short circuit	AI	687 central	T2 X1	A
ee031	Signal logoff or short circuit	AI	687 central	T2 X2	A
ee032:	External Humidity probe faulty	AI	687 central	T2 X3	A
ee033:	Cabinet temperature probe faulty	AI	687 central	T2 X4	A
ee034:	Hydronic module on the ProcessBus is disconnected			peripheral bus	A
ee035:	Cool opening valve: error limit	DI	945 4P	X2	A
ee036:	Heat opening valve: error limit	DI	945 4P	X4	A
ee037:	Cool closing valve: error limit	DI	945 4P	X1	A
ee038:	Heat closing valve: error limit	DI	945 4P	X3	A
ee039:	Communication timeout 4P module	Logico	945 4P	peripheral bus	A
ee040:	FCI module water temperature probe fault	AI	955 FCI	X1	A
ee041:	Communication timeout FCI module	Logico	955 FCI	peripheral bus	A
EE044:	FCI module P1 thermal protection	DI	955 FCI	X5	M
EE045:	FCI module P2 thermal protection	DI	955 FCI	X6	M
EE046:	FCI module P3 thermal protection	DI	955 FCI	X7	M
ee050:	User side exchanger, differential pressure probe fault		965 hydronic	X3	A
ee054:	Recovery pump thermal protection	DI	955 FCI	X6	A
ee101:	Circuit 1 module on the ProcessBus is disconnected			peripheral bus	A
ee102:	Driver 1 module on the ProcessBus is disconnected			peripheral bus	A
ee103:	Recovery 1 module on the ProcessBus is disconnected			peripheral bus	A
ee104:	Driver 1 blocked		94U driver		A

code	detailed description	t.i.	module	input	t.a.
EE106:	Compressor 1 thermal protection	DI	985 circuit 1	T4 D1	M
EE107:	Compressor 2 thermal protection	DI	985 circuit 1	T4 D2	M
EE108:	Compressor 3 thermal protection	DI	985 circuit 1	T4 D3	M
EE118:	Source side protection	DI	985 circuit 1	T9 DL2	M
ee122:	Faulty probe - discharge temperature compressor 1	AI	985 circuit 1	T1 B1	A
ee123:	Faulty probe - discharge temperature compressor 2	AI	985 circuit 1	T1 B2	A
ee124:	Faulty probe - discharge temperature compressor 3	AI	985 circuit 1	T2 X2	A
ee125:	Faulty probe - source 1 temperature	AI	985 circuit 1	T1 B3	A
ee126:	Faulty probe - source 2 temperature	AI	985 circuit 1	T2 X1	A
ee127:	Faulty probe - Suction temperature	AI	94U driver	T2 X2	A
ee128:	Faulty probe - discharge pressure	AI	985 circuit 1	T2 X3	A
ee129:	Faulty probe - suction pressure	AI	94U driver	T1 X1	A
ee130:	Faulty probe - Recovery gas temperature	AI	965 recovery	T1 X1	A
ee131:	Faulty probe - Recovery pressure	AI	965 recovery	T2 X7	A
ee132:	Faulty probe - Water recovery inlet	AI	965 recovery	T1 X2	A
ee133:	Faulty probe - Water recovery outlet	AI	965 recovery	T1 X3	A
ee135:	Bios wrong version		985 circuit 1		A
ff105:	Low overheating Thermostatic C1				A
ff109:	Low pressure from analogic input	DI	985 circuit 1	T3 X7	A/M
ff110:	Pre-alarm - low pressure COOL mode				A
ff111:	Pre-alarm - low pressure HEAT mode				A
ff112:	Low pressure from analogic input	AI	94U driver	T1 X1	A/M
ff113:	High pressure from digital input	DI	985 circuit 1	T3 X8	A/M
ff114:	Pre-alarm - high pressure				A
ff115:	High pressure from analogic input	AI	985 circuit 1	T2 X3	A/M
ff116:	Pre-alarm max. compression ratio (high pressure / low pressure)				A
ff117:	Min. compression ratio (high pressure / low pressure)				A/M
FF119:	Alarm max. compression ratio (high pressure / low pressure)				M
FF134	Empty circuit	AI	94U driver	T1 X1	M
ff136:	Defrost: low gas temperature	Logico	985	X2	M
ff137:	Oil pressure	DI	985	DL1	A/M
ff138:	Low condensing pressure	Logico	985	X3	A
ff139:	Maximum saturated condensation temperature	Logico			A/M
ff140:	Minimum saturated condensation temperature	Logico			A/M
ff141:	Maximum saturated evaporation temperatur	Logico			A/M
ff142:	Minimum saturated evaporation temperatur	Logico			A/M
ff143:	Maximum compression ratio	Logico			A/M
FF144:	Minimum compression ratio	Logico			M
ff145:	Maximum engine torque	Logico			A/M
il002:	Low water pressure	DI	687 central	T5 DU1	A/M
il006:	Flow switch utility side	DI	687 central	T3 X8	A/M
il007:	Freeze alarm utility side				M
ii008:	Utility side pumps On for antifreeze alarm				A
il009:	COOL: outlet temperature higher than inlet temperature HEAT: inlet temperature higher than outlet temperature				A
il120:	Flow switch source side	DI	985 circuit 1	T2 X4	A/M
il121:	Freeze alarm source side				A
il042:	FCI module, system pressure	DI	955 FCI	X3	M
il043:	FCI module, antifreeze alarm	Logico	955 FCI	X1	M
ii047:	FCI module, water flow alarm	DI	955 FCI	X4	A
ii052:	Recosery module, flow alarm	DI	965 REC	X6	A
ii053:	Recovery module, system pressure	DI	965 REC	X6	A



## 8 Maintenance

### 8.1 General description

Maintenance must be done by authorized centres or by qualified personnel.

The maintenance allows to:

- maintain the unit efficiency
- increase the life span of the equipment
- assemble information and data to understand the state of the unit efficiency and avoid possible damages

Before checking, please verify the following:

- the electrical power supply line should be isolated at the beginning
- the unit isolator is open, locked and equipped with the suitable warning
- make sure no tension is present



After turning off the power, wait at least 5 minutes before accessing to the electrical panel or any other electrical component.



Before accessing check with a multimeter that there are no residual stresses.

### 8.2 Inspections frequency

Perform an inspection every 6 months minimum.

The frequency, however, depends on the use.



In the event of frequent use it is recommended to plan inspections at shorter intervals:

- frequent use (continuous or very intermittent use, near the operating limits, etc)
- critical use (service necessary)

√	intervention frequency (months)	1	6	12
1	presence corrosion			X
2	panel fixing			X
3	fan fixing		X	
4	coil cleaning		X	
5	water filter cleaning		X	
6	check the exchanger efficiency			X
7	circulating pumps		X	
8	check of the fixing and the insulation of the power lead			X
9	check of the earthing cable			X
10	electric panel cleaning			X
11	capacity contactor status			X
12	termina closing, cable insulation integrity			X
13	voltage and phase unbalancing (no load and on-load)		X	
14	absorptions of the single electrical loads		X	
15	test of the compressor crankcase heaters		X	
16	leak control*			X
17	survey of the refrigerant circuit operating parameters		X	
18	protective device test: pressure switches, thermostats, flow switches etc..		X	
19	control system test: setpoint, climatic compensations, capacity stepping, water / air flow-rate variations		X	
20	control device test: alarm signalling, thermometers, probes, pressure gauges etc..		X	

\* European regulation 303/2008

Refer to the local regulations; and ensure correct adherence. Companies and technicians that effect interventions of installation, maintenance/repairs, leak control and recovery must be CERTIFIED as expected by the local regulations. The leak control must be effected with annual renewal.

### 8.3 Unit booklet

It's advisable to create a unit booklet to take notes of the unit interventions.

In this way it will be easier to adequately note the various interventions and aid any troubleshooting.

Report on the booklet:

- date
- type of intervention effected
- intervention description
- carried out measures etc.

### 8.4 Standby mode

If a long period of inactivity is foreseen:

- turn off the power
- avoid the risk of frost (empty the system or add glycol)

Turn off the power to avoid electrical risks or damages by lightning strikes.



With lower temperatures keep heaters turned on in of the electrical panel (option).

It's recommended that the re-start after the stopping period is performed by a qualified technician, especially after seasonal stops or seasonal switching.

When restarting, refer to what is indicated in the "start-up" section.

Schedule technical assistance in advance to avoid hitches and to guarantee that the system can be used when required.

### 8.5 Water side exchanger

It is very important for the exchanger to be able to provide the maximum thermal exchange, therefore it is essential for the inner surfaces to be clean of dirt and incrustations.

Periodically check the difference between the temperature of the supply water and the condensation temperature: if the difference is greater than 8°C–10°C it is advisable to clean the exchanger.

The clearing must be effected:

- with circulation opposite to the usual one
- with a speed at least 1,5 times higher than the nominal one
- with an appropriate product moderately acid (95% water + 5% phosphoric acid)
- after the cleaning rinse with water to inhibit the action of any residual product

### 8.6 Water filter

Check that no impurities prevent the correct passage of water.

### 8.7 Circulating pumps

Check:

- no leaks
- bearing status (anomalies are highlighted by abnormal noise and vibration)
- the terminal protection covers are closed and the cable holders are properly positioned

### 8.8 Flow Switch

- controls the operations
- remove incrustations from the palette

### 8.9 Electric fans

Check:

- the fans and the relative protection grids are well fixed
- the fan bearings (evident by noise and anomalous vibrations)
- the terminal protection covers are closed and the cable holders are properly positioned

## 8.10 Air coil



Contact with the exchanger fins can cause cuts: wear protective gloves to perform the above described operations.

It is extremely important that the battery gives the maximum thermal exchange; therefore, its surface must be cleaned from dust and deposits. Remove all impurities from the surface.

Using an air pressure gun, clean the aluminum surface of the battery; be careful to direct the air in the opposite direction of the fan air movement.

Hold the gun parallel to the fins to avoid damages.

As an alternative, vacuum cleaner can be used to suck impurities from the air input side.



Verify that the aluminum fins are not bent or damaged, in the event of damages contact the authorized assistance center and get the fins straightened in order to restore the initial condition for an optimal air flow.

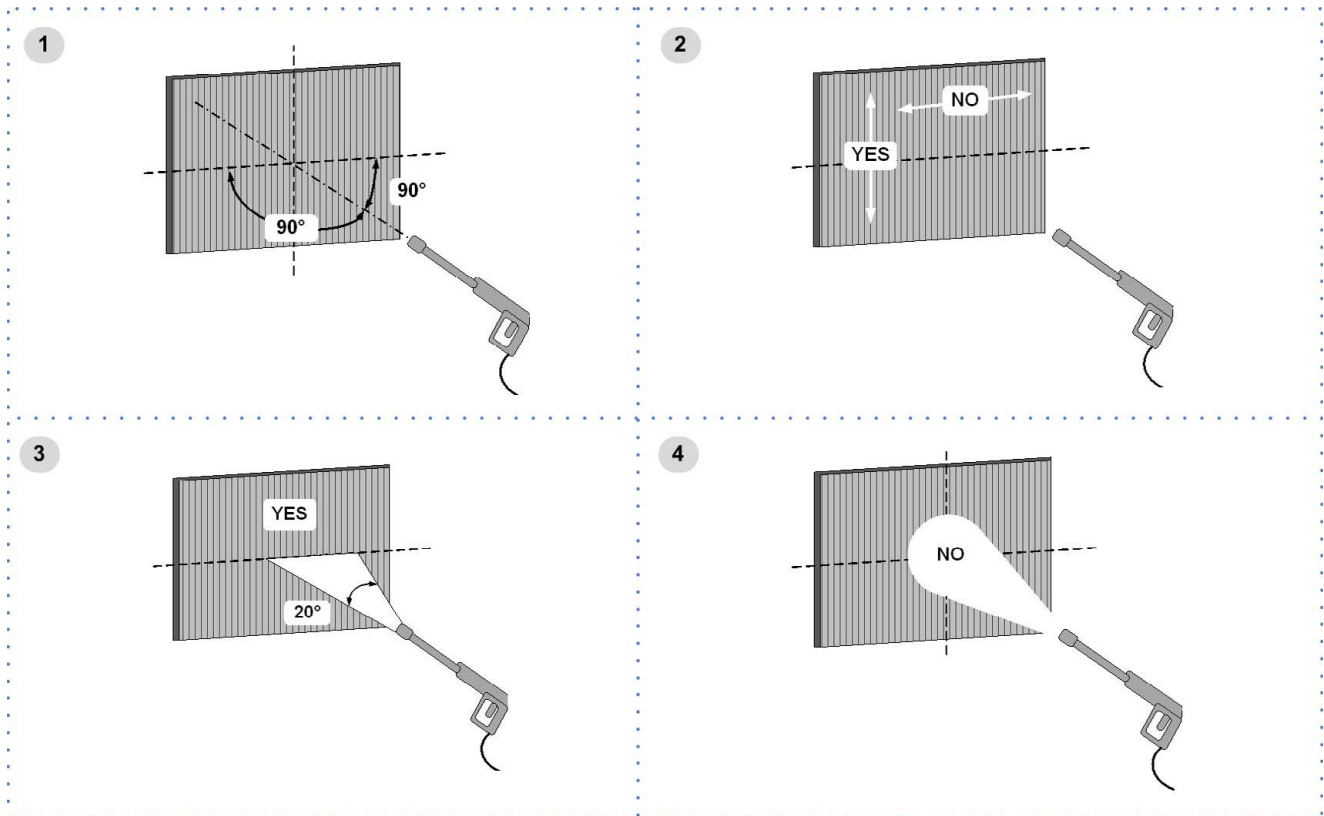

## 8.11 Compressor supply line shut-off valve



A. Supply line shut-off valve



**CAUTION!**

Do not remove the seal

Remove only if authorized by the manufacturer.

Please contact the maker for informations.

## 8.12 Screw compressors - Periodical checks

Operating hours	100	1000	5000	10000	15000	20000	25000	30000
Vibrations / Noise	C	C	C	C	C	C	C	C
Oil level	C	C	C	C	C	C	C	C/R
Oil filter	C		C		C		C	C/R
Filter the suction			C		C		C	C
Electric insulation		C	C	C	C	C	C	C
Bearings								C/R
check valve		C	C	C	C	C	C	C

C = CHECK

R = replace

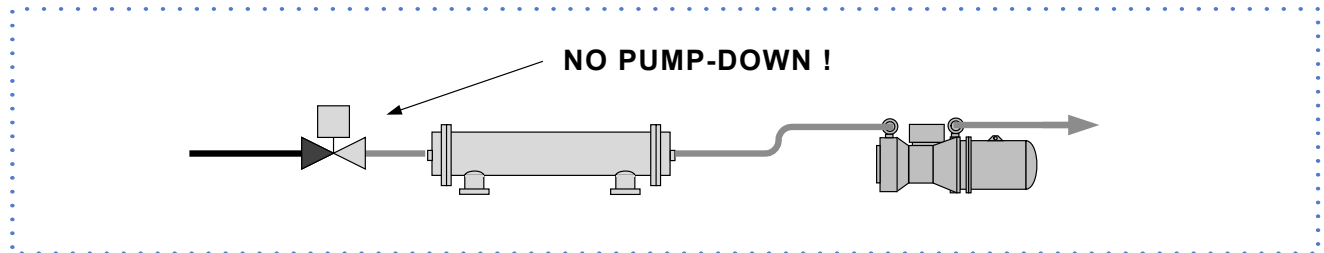

## 8.13 System discharge

1. evacuate the system
2. It is possible to limit the absorbed electric power with an external signal 0-10 Vcc or 4-20mA.
3. evacuate the exchanger, use all the cocks presents
4. use compressed air to blow the exchanger
5. dry completely the exchanger by an hot air jet; for greater safety fill the exchanger with glycoled solution
6. protect the exchanger from the air
7. remove the drain plugs to the pumps

⚠ Any anti-freeze liquid contained in the system should not be discharged freely as it is a pollutant.

⚠ It must be collected and reused.

⚠ Before starting a washing the plant.

Example

- A. emptying evaporator
- B. emptying pump

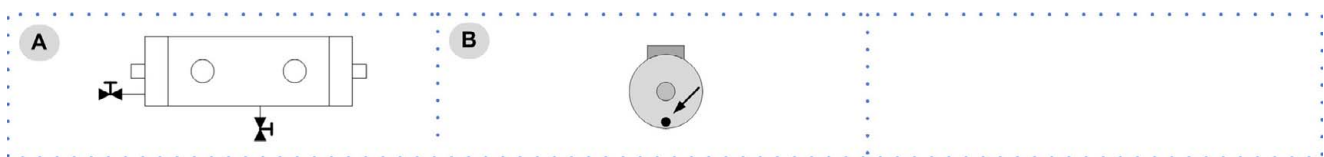

It's recommended that the re-start after the stopping period is performed by a qualified technician, especially after seasonal stops or seasonal switching.

When restarting, refer to what is indicated in the "start-up" section.

Schedule technical assistance in advance to avoid hitches and to guarantee that the system can be used when required.

## 8.14 Insulations

Check the condition of the insulations: if necessary apply glue and and renew the seals.

## 9 Status

The status code identifies the concerned circuit:

Example:

S 1 100:CMP1 compressor1 starts = circuit 1

S 2 100:CMP1 compressor1 starts = circuit 2

The number of refrigerant circuits depends on series and size of the unit.

Example:

### AI-687 T.IN H2Outil\_B1 Inlet water temperature

AI = analogic input

687 = main module

B1 = PIN

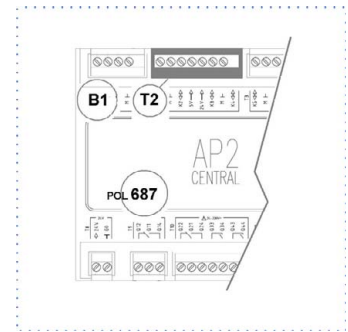

### 9.1 General stata and central module

code	description	detailed description
AI-687	T.IN H2Outil_B1	Inlet water temperature utility side
AI-687	T.OUT H2Outil_B2	Outlet water temperature user side
AI-687	Ext.Air temp_B3	Outdoor air temperature
AI-687	S.DemandLimit_X1	Signal of the demand limit function controls
AI-687	S.WaterReset_X2	Signal of the water reset function controls
AI-687	RHExt_X3	Outside relative humidity
AI-687	El.CabinetTemp_X4	Electrical panel temperature
AO-687	%FREE-COOLING_X5	Percentage value of the status of the external control signal of the ventilation/FREE-COOLING valve
DI-687	Sel.SetPoint_DU2	Status of the second digital input setpoint 0=1°set 1=2°Set
DI-687	SystemPressure_DU1	Status of the system water pressure sensor 0=OK 1=Fault
DI-687	FlowUser_X8	Status of the differential pressure switch/utilisation flow 0=OK 1=Fault
DI-687	ON-OFFRem_X7	Status of the unit status digital input 0=OFF 1=On
DI-687	Heat/CoolRem_X6	Status of the unit mode digital input 0=Heat 1=Cool
DI-687	PhaseMonitor_DL1	Status of the phase monitor input 0=OK 1=Fault
DI-687	OvIP1Util_D2	Status of thermal protection contact of utilisation pump 1 0=OK 1=Fault
DI-687	OvIP2Util_D1	Status of thermal protection contact of utilisation pump 2 0=OK 1=Fault
DI-687	OvIP3Util_DL2	Status of thermal protection contact of utilisation pump 3 0=OK 1=Fault
DO-687	El.CabinetFAN_DO1	Status of the ventilation control of the electrical panel: 0=Off 1=On
DO-687	El.CabinetHEAT_DO2	Status of the heating control of the electrical panel: 0=Off 1=On
DO-687	UnitMode_Q1	Status of the digital output related to the operating mode (N.O. Open=Cool N.O. Closed=Heat): 0=Cool 1=Heat
DO-687	Cumul.Alarm_Q2	Unit cumulative alarm status (N.O.Open=All OFF N.O. Closed=All ON): 0=Off 1=On
DO-687	CmdP1User_Q3	Command pump 1 utility side: 0=Off 1=On
DO-687	CmdP2User_Q4	Command pump 2 utility side: 0=Off 1=On
DO-687	CmdP3User_Q5	Command pump 3 utility side: 0=Off 1=On
DO-687	OpenYV_FC_Q7	Opening control of the FREE-COOLING valve FC Closed = ON: 0=Off 1=On
DO-687	CloseYV_FC_Q8	Closure control of the FREE-COOLING valve FC Closed = OFF: 0=Off 1=On
DO-687	AntifreezeHeater_Q6	Status of the control of the antifreeze heaters: 0=Off 1=On
S0001	StartsP1User	Number of startup totalized from Pump 1
S0002	StartsP2User	Number of startup totalized from Pump 2
S0003	StartsP3User	Number of startup totalized from Pump 3
S0004	Pump1 running hours	Utilisation pump 1 hours
S0005	Pump2 running hours	Utilisation pump 2 hours
S0006	Pump3 running hours	Utilisation pump 3 hours
S0007	Antifreeze heat.	Antifreeze heater status 0=Off 1=On
S0008	Pump in antifreeze	Status of the utilisation pump for antifreeze protection 0=Off 1=On
S0009	Recovery	Recovery status: 0=Off 1=On
S0010	ActualSptTExt	Setpoint value calculated by the Text climate curve
S0011	ActualSptWR	Setpoint value calculated by the WaterReset function

code	description	detailed description
S0012	StatusFREE-COOLING	FREE-COOLING status 0=Off 1=On
S0013	GenWarning	0=Off 1=On
S0014	GenBlock	0=Off 1=On
S0015	NCompOnUnit	Number of compressors currently active on the machine

## 9.2 Circuit 1 status

code	description	detailed description
AI-94U	SuctionTemp_X2	Suction temperature
AI-94U	SuctionPressureX1	Low pressure transducer
AI-985	DischargeTC1_B1	Compressor 1 discharge temperature
AI-985	DischargeTC2_B2	Compressor 2 discharge temperature
AI-985	DischargeTC3_X2	Compressor 3 discharge temperature
AI-985	SourceTemp1_B3	Source 1 temperature (for machines with air-based sources and reversible on gas = Probe 1 on source battery. For machines with water-based source = Source input probe)
AI-985	SourceTemp2_X1	Source 2 temperature (for machines with air-based sources and reversible on gas = Probe 2 on source battery. For machines with water-based source = Source outlet probe)
AI-985	DischargePressure_X3	High pressure transducer
AO-985	%Cmd Cmp_X5	Percentage value of the status of the control signal of the modulating compressor
AO-985	%Cmd Source_X6	% value source modulating signal control
DI-985	Source WaterFlow_X4	Status of the source flow contact (Only active on machines with water-based source): 0=Fault 1=OK
DI-985	LP Pressure switch_X7	Status of the LP-pressure switch contact: 0=Fault 1=OK
DI-985	Ovl Inverter_DL1	Status of the inverter compressor heater contact: 0=Fault 1=OK
DI-985	HP Pressure switch_X8	Status of the HP-pressure switch contact: 0=Fault 1=OK
DI-985	Ovl Source_DL2	Status of the contact of the thermal protection of the source motors: 0=Fault 1=OK
DI-985	Ovl Cmp1_D1	Status of the contact of the thermal protection of compressor 1: 0=Fault 1=OK
DI-985	Ovl Cmp2_D2	Status of the contact of the thermal protection of compressor 2: 0=Fault 1=OK
DI-985	Ovl Cmp3_D3	Status of the contact of the thermal protection of compressor 3: 0=Fault 1=OK
DI-985	Diff.PressureOils-crew_D2	Status of the oil differential pressure switch contact (Active if compressor = Screw): 0=Fault 1=OK
DI-985	EnCircScrew_D3	Status of the circuit enabling input contact (Active if compressor = Screw): 0=Fault 1=OK
DO-985	Cmd Cmp1_Q2	Status of the compressor 1 control: 0=Off 1=On
DO-985	Cmd Cmp2_Q3	Status of the compressor 2 control: 0=Off 1=On
DO-985	Cmd Cmp3_Q4	Status of the compressor 3 control: 0=Off 1=On
DO-985	Cmd Source_Q1	Status of the source motor control: 0=Off 1=On
DO-985	Cmd Inj.Cmp1_Q5	Status of the compressor 1 liquid injection valve control: 0=Off 1=On
DO-985	Cmd Inj.Cmp2_Q7	Status of the compressor 2 liquid injection valve control: 0=Off 1=On
DO-985	Cmd Inj.Cmp3_Q8	Status of the compressor 3 liquid injection valve control: 0=Off 1=On
DO-985	Cmd YV4 reversing-Valve_Q6	Status of the cycle inversion valve control: 0=Off 1=On
DO-985	Cmd Digital_DO2	Status of the button valve control for compressors PWM: 0=Off 1=On
DO-985	Cmd KMLine_Q2	Status of the line counter control for the power supply Cmp (Active if compressor = Screw): 0=Off 1=On
DO-985	Cmd KMPW1_Q3	Status of the control of the motor's 1st winding (with PartWiding start-up) / Status of the star contactor control (with delta start-up)(Active if compressor = Screw): 0=Off 1=On
DO-985	Cmd KMPW2_Q4	Status of the control of the motor's 2nd winding (with PartWiding start-up) / Status of the control of the triangle contactor (with delta start-up)(Active if compressor = Screw): 0=Off 1=On
DO-985	Cmd YV25%_Q7	Status of the start e stop valve YV25%(Active if compressor = Screw): 0=Off 1=On
DO-985	Cmd YV75%_Q8	Status of the valve control of the YV75%(CR3_Bitzer) (14_RefComp) (Active if compressor = Screw): 0=Off 1=On
DO-985	Cmd YVUP_DO1	Status of the power increase valve control (CR4_Bitzer) (16_RefComp) (Active if compressor = Screw): 0=Off 1=On
DO-985	Cmd YVDW_DO2	Status of the power decrease valve control (CR2_Bitzer) (15_RefComp) (Active if compressor = Screw): 0=Off 1=On
S1100	CMP1 starts	Number of startup totalized from Compressor 1
S1101	CMP2 starts	Number of startup totalized from Compressor 2
S1102	CMP3 starts	Number of startup totalized from Compressor 3
S1103	StartsScrew	Number of startup totalized from Compressor
S1104	Source starts	Number of startup totalized from source Fan or pump
S1105	Hours Comp.1	Compressor 1 hours

code	description	detailed description
S1106	Hours Comp.2	Compressor 2 hours
S1107	Hours Comp.3	Compressor 3 hours
S1108	HoursScrew	Screw compressor hours
S1109	HoursSource	Screw compressor hours
S1110	Total steps	Total number of active steps on the circuit
S1111	Comp.1 status	Compressor 1: 0=free 1=on 2=timing 3=Disabled
S1112	Comp.2 status	Compressor 2: 0=free 1=on 2=timing 3=Disabled
S1113	Comp.3 status	Compressor 3: 0=free 1=on 2=timing 3=Disabled
S1114	Current cap.	Capacity currently used up on the circuit
S1115	Requested cap.	Capacity required on the circuit
S1116	Pressure ratio	Compression ratio status (1+HP/1+LP)
S1117	FANPreAlarm	Status of the current maximum ventilation pre-alarm 0=Off 1=On
S1118	Defrost delay	Current value of the countdown towards the cycle inversion due to defrosting. (defrosting starts when the value reaches zero)
S1119	Defrosting status	Indicates the defrosting status 0=DfrOff (Cycle inversion phase for defrosting phase NOT active) 1=DfrON (Cycle inversion phase for defrosting phase ACTIVE)
S1120	HWErr	Hardware error of the POL94U module that does not preclude the possibility of moving the valve or closing it. Possible causes: anomalous voltage values in the valve motor 0=Off 1=On
S1121	BlckingHWErr	Hardware error of the POL94U module that prevents the electronic valve from moving. Possible causes: UPS not available, wrong POL94U Bios, HW POL94U Error, Disconnected EEV Motor, calibration error associated with configuration parameters. 0=Off 1=On
S1122	FailSafeSta	Active block status: 0=Off 1=On
S1123	UPSNotAval	UPS failure: 0=Off 1=On
S1124	CircWarning	Status associated with circuit block alarm
S1125	CircBlock	Lock alarm circuit
S1126	ThTDischarge	Theoretical discharge temperature

### 9.3 Thermostatic C1 status

code	description	detailed description
S1200	SHSpOp	Operating overheating setpoint net with SH and MET adjustments
S1201	AlCalSuctSprHtP	Actual Overheating SetPoint
S1202	ECVState	0 = Idle 1 = ECValarm 2 = FailSafe 3 = Referencing 4 = Positioning 5 = Positioned 6 = ECVWaiting 7 = FastClosing
S1203	EEV:SH_Limiter	Maximum valve opening determined by the minimum SH control function
S1204	EEV:LET_Limiter	Status of the minimum LET intake temperature control
S1205	EEVMode	0=Idle (motor off) 1=Init (valve initialised when completely closed) 2=Manual (valve controlled in manual mode) 3=Control (the valve conducts adjustments to control SH)
S1206	Prepos	Thermostatic requested positioning %
S1207	ECVSetPos	% Opening valve if EEVMod = Manual
S1208	ECVMode	0 = Idle 1 = Init 2 = Position 3 = FastClose
S1209	SHPIDOut	% value of the PID output to adjust the valve
S1210	EEVStatus	0 - Closed (Ready) 1 - StartUpPositioning 2 - StartUpPositioned 3 - SuperHeat 4 - Prepositioning 5 - MET 6 - LET 7 - Closing 8 - PumpDown 9 - DangAlarm 10 - PumpDownStartUp 11 - ECValarm 12 - MinSHLmtr 13 - WaitValveClose 255 - Warning
S1211	SetPosSteps	Control of the number of steps the valve must reach to adjust overheating
S1212	SetPos%	Opening % control of the valve to adjust overheating
S1213	Pol94xCommOK	Connection status of the POL94U module on processbus: 0=NotOK 1=OK
S1214	ActPos%	% value of the actual position valve EEV
S1215	ActPosSteps	Current number of steps of the EEV valve
S1216	ECVMode	0 = Idle 1 = Init 2 = Position 3 = FastClose
S1217	ECVState	0 = Idle 1 = ECValarm 2 = FailSafe 3 = Referencing 4 = Positioning 5 = Positioned 6 = ECVWaiting 7 = FastClosing

### 9.4 Recovery circuit 1 status

code	description	detailed description
AI-965	P.OutRec_X7	Pressure value recovery circuit
AI-965	T.InH2ORec_X2	Recovery inlet water temperature

code	description	detailed description
AI-965	T.OutH2ORec_X3	Recovery outlet water temperature
AI-965	T.OutGasRec_X1	Recovery gas outlet temperature (liquid)
AO-965	%CmdPmpRec_X8	% 0-10vcc signal value recovery variable pump
DI-965	EnableRec_X4	Enabling recovery input: 0=Fault 1=OK
DI-965	Ovl PmpRec_X5	Recovery thermal protection pump 0=Fault 1=OK
DI-965	FlowRec_X6	Flow recovery 0=Fault 1=OK
DI-965	SystemPress.Recovery_DL1	State of the water pressure switch contact of the system 0=Fault 1=OK
DO-965	YV1Rec_DO1	Command valve YV1 0=Off 1=On
DO-965	YV2Rec_DO2	Command valve YV2 0=Off 1=On
DO-965	YV3Rec_Q1	Command valve YV3 0=Off 1=On
DO-965	YV4Rec_Q2	Command valve YV4 0=Off 1=On
DO-965	YV5Rec_Q3	Command valve YV5 0=Off 1=On
DO-965	PmpRec_Q4	Recovery pump command 0=Off 1=On

## 9.5 Master slave status

code	description	detailed description
S0600	SetPoint Unit1	Value accessible from the display of the unit machine network master. Working setpoint master unit (Address 1 on peripheralbus)
S0601	SetPoint Unit2	Value accessible from the display of the unit machine network master. Working setpoint unit 2 (Address 2 on peripheralbus)
S0602	SetPoint Unit3	Value accessible from the display of the unit machine network master. Working setpoint unit 3 (Address 3 on peripheralbus)
S0603	SetPoint Unit4	Value accessible from the display of the unit machine network master. Working setpoint unit 4 (Address 4 on peripheralbus)
S0604	SetPoint Unit5	Value accessible from the display of the unit machine network master. Working setpoint unit 5 (Address 5 on peripheralbus)
S0605	SetPoint Unit6	Value accessible from the display of the unit machine network master. Working setpoint unit 6 (Address 6 on peripheralbus)
S0606	SetPoint Unit7	Value accessible from the display of the unit machine network master. Working setpoint unit 7 (Address 7 on peripheralbus)
S0607	statusUnit1	Value accessible from the display of the unit machine network master. Status master unit 7 0=Off 1=Eco 2=On 3=PmpOn
S0608	StatusUnit2	Value accessible from the display of the unit machine network master. Status unit 2 0=Off 1=Eco 2=On 3=PmpOn
S0609	StatusUnit3	Value accessible from the display of the unit machine network master. Status unit 3 0=Off 1=Eco 2=On 3=PmpOn
S0610	StatusUnit4	Value accessible from the display of the unit machine network master. Status unit 4 0=Off 1=Eco 2=On 3=PmpOn
S0611	StatusUnit5	Value accessible from the display of the unit machine network master. Status unit 5 0=Off 1=Eco 2=On 3=PmpOn
S0612	StatusUnit6	Value accessible from the display of the unit machine network master. Status unit 6 0=Off 1=Eco 2=On 3=PmpOn
S0613	StatusUnit7	Value accessible from the display of the unit machine network master. Status unit 7 0=Off 1=Eco 2=On 3=PmpOn

## 9.6 Hydronic module status

code	description	detailed description
AO-965	%CmdInverter_X7	% value inverter command signal
DI-965	OvlP1.Hid_X4	Pump 1 overload 1: 0=OK 1=Fault
DI-965	OvlP2.Hid_X5	Pump 2 overload: 0=OK 1=Fault
DI-965	OvlP3.Hid_X6	Pump 3 overload: 0=OK 1=Fault
DI-965	OvlInv.Hid_DL1	Inverter overload: 0=OK 1=Fault
DO-965	CmdP1.Hid_DO1	Pump 1 command: 0=Off 1=On
DO-965	CmdP1Inv.Hid_Q2	Pump 1 inverter command: 0=Off 1=On
DO-965	CmdP2.Hid_DO2	Pump 2 command: 0=Off 1=On
DO-965	CmdP2Inv.Hid_Q3	Pump 2 inverter command: 0=Off 1=On



code	description	detailed description
DO-965	CmdP3.Hid_Q1	Pump 3 command: 0=Off 1=On
DO-965	ComdP3Inv.Hid_Q4	Pump 3 inverter command: 0=Off 1=On
DO-965	CmdInverter:X8	Hydronic inverter command: 0=Off 1=On
S0500	StartsP1Hidro	Hydronic module pump 1 starts
S0501	StartsP2Hidro	Hydronic module pump 2 starts
S0502	StartsP3Hidro	Hydronic module pump 3 starts
S0503	HoursP1.Hid	Hydronic module pump 1 hours
S0504	HoursP2.Hid	Hydronic module pump 2 hours
S0505	HoursP3.Hid	Hydronic module pump 3 hours
S0506	HoursInverter.Hid	Hydronic module inverter hours

## 9.7 Energy meter status

code	description	detailed description
S0720	U12	L1 - L2 voltage
S0721	U23	L2 - L3 voltage
S0722	U31	L3 - L1 voltage
S0723	Freq	Frequency
S0724	IL1	L1 current
S0725	IL2	L2 current
S0726	IL3	L3 current
S0727	Ptotale	Current active power
S0728	Cosfi	Total power factor
S0729	Energy	Active energy totalized
S0730	THD-U12	Sum of harmonic components of voltage between L1 e L2
S0731	THD-U23	Sum of harmonic components of voltage between L2 e L3
S0732	THD-U31	Sum of harmonic components of voltage between L3 e L1

## 10 Accessories

### 10.1 Partial energy recovery

A configuration which enables the production of hot water free-of-charge while operating in the cooling mode, thanks to the partial recovery of condensation heat that would otherwise be rejected to the external heat source.

The maximum capacity available from the partial recovery is equal to the 15% of the rejected heating capacity (cooling capacity + compressor power input)

When the temperature of the water to be heated is particularly low, it is wise to insert a flow-rate control valve into the system water circuit, in order to maintain the temperature at the recovery output at above 35°C and thus avoid the condensation of the refrigerant into the partial energy recovery device.

- ⚠ The recovery exchanger must be always maintained full of water
- The lack of water amplifies the noise generated by the operation

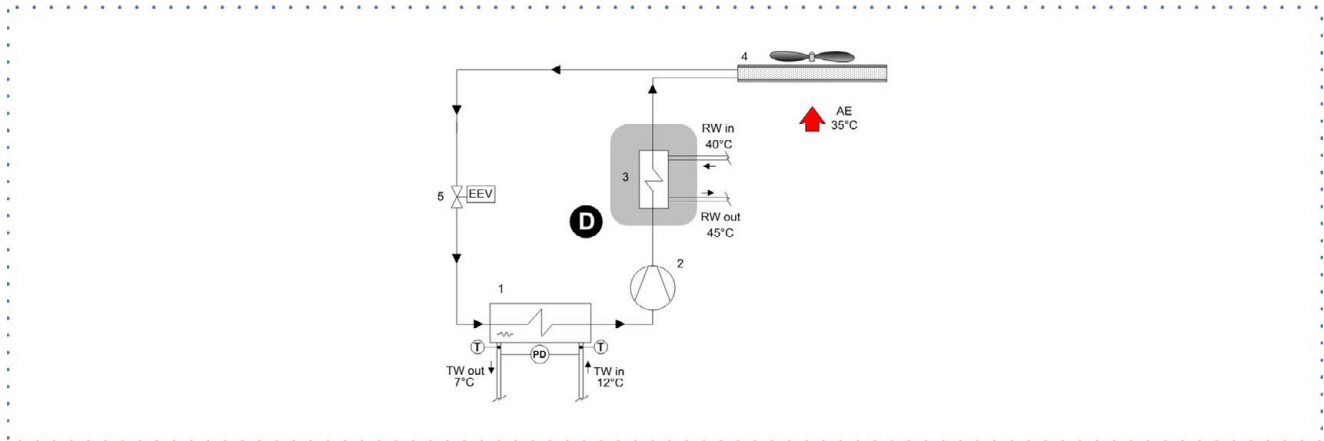

D - Partial recovery device

1. Internal exchanger
2. Compressors
3. Recovery exchanger
4. External exchanger
5. Electronic expansion valve

TW in chilled water inlet

TW out chilled water outlet

RW in - Recovery water inlet  
RW out - Recovery water outlet

T - Temperature probe  
PD - Differential pressure switch  
AE Outdoor air

When the temperature of the water to be heated is particularly low, it is wise to insert a flow-rate control valve into the system water circuit, in order to maintain the temperature at the recovery output at above 35°C and thus avoid the condensation of the refrigerant into the partial energy recovery device.

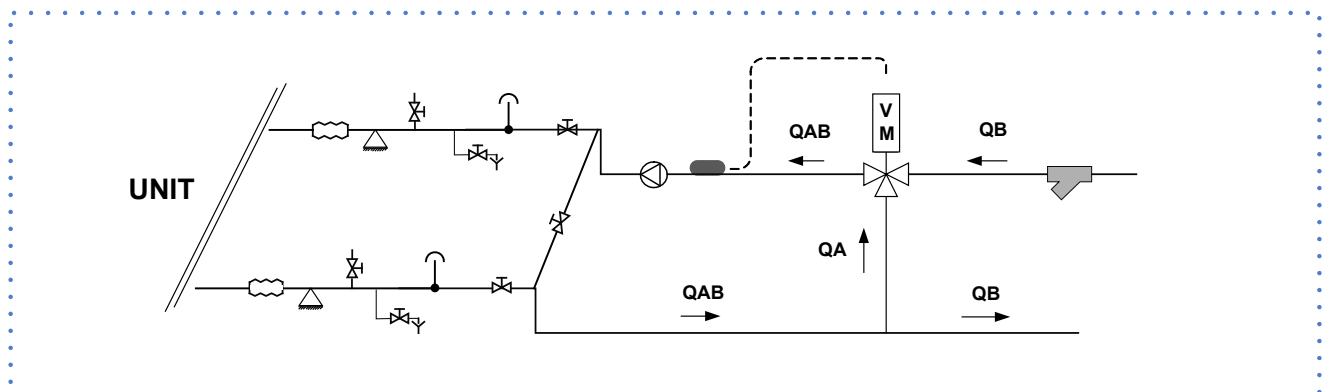

## 10.2 Total energy recovery

A configuration which enables the production of hot water free-of-charge while operating in the cooling mode, thanks to the partial recovery of condensation heat that would otherwise be rejected to the external heat source.

Hot water availability is always subordinate to the production of chilled water.

See the following example:

Refrigeration capacity request	Heat capacity request	
100%	0%	Production of refrigeration capacity only
100%	100%	Production of refrigeration capacity and Production of heat capacity using recovery
50%	100%	Production of refrigeration capacity and Production of heat capacity using recovery, equals 50% of the heat capacity request

⚠ To prevent constant switching in the unit's refrigeration circuit, it is necessary to install a storage tank with an adequate capacity in the system's hot water circuit.

⚠ In the absence of hot water circulating in the recovery exchanger, the maximum entering air temperature is reduced by approximately 2°C compared with the unit without "Total Energy Recovery" mode.

### A - Total operating energy recovery

When hot water is requested, the condensing coil is deactivated. Condensation takes place wholly within the recovery circuit.

### B - Total non-operating energy recovery

When the recovery set-point has been satisfied, the condensing coil is reactivated. In this condition, the total recovery circuit operates as a Partial recovery circuit (Desuperheater).

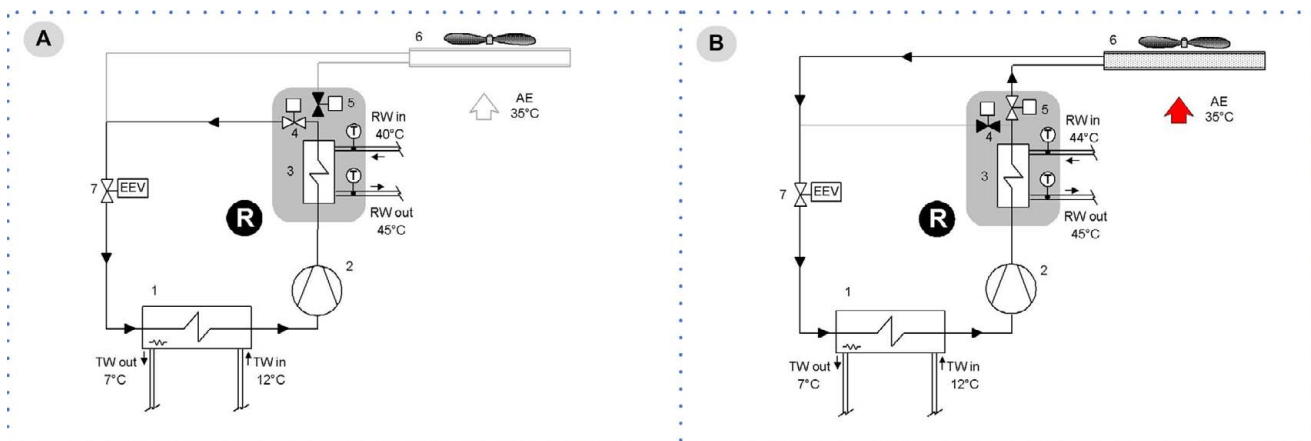

R - Total recovery device

1. Internal exchanger
2. Compressors
3. Recovery exchanger
4. Total recovery enabling valve
5. External exchanger enabling valve
6. External exchanger
7. Electronic expansion valve

TW in chilled water inlet  
TW out chilled water outlet

RW in - Recovery water inlet  
RW out - Recovery water outlet

T - Temperature probe  
AE Outdoor air

### 10.3 HydroPack

Pumping unit made up of two or three electropumps laid out in parallel, with auto-adaptive modular logic activation.

It enables the automatic reduction of the liquid flow rate in critical conditions, avoiding blocks due to overloading and consequential intervention work by specialised technical personnel.

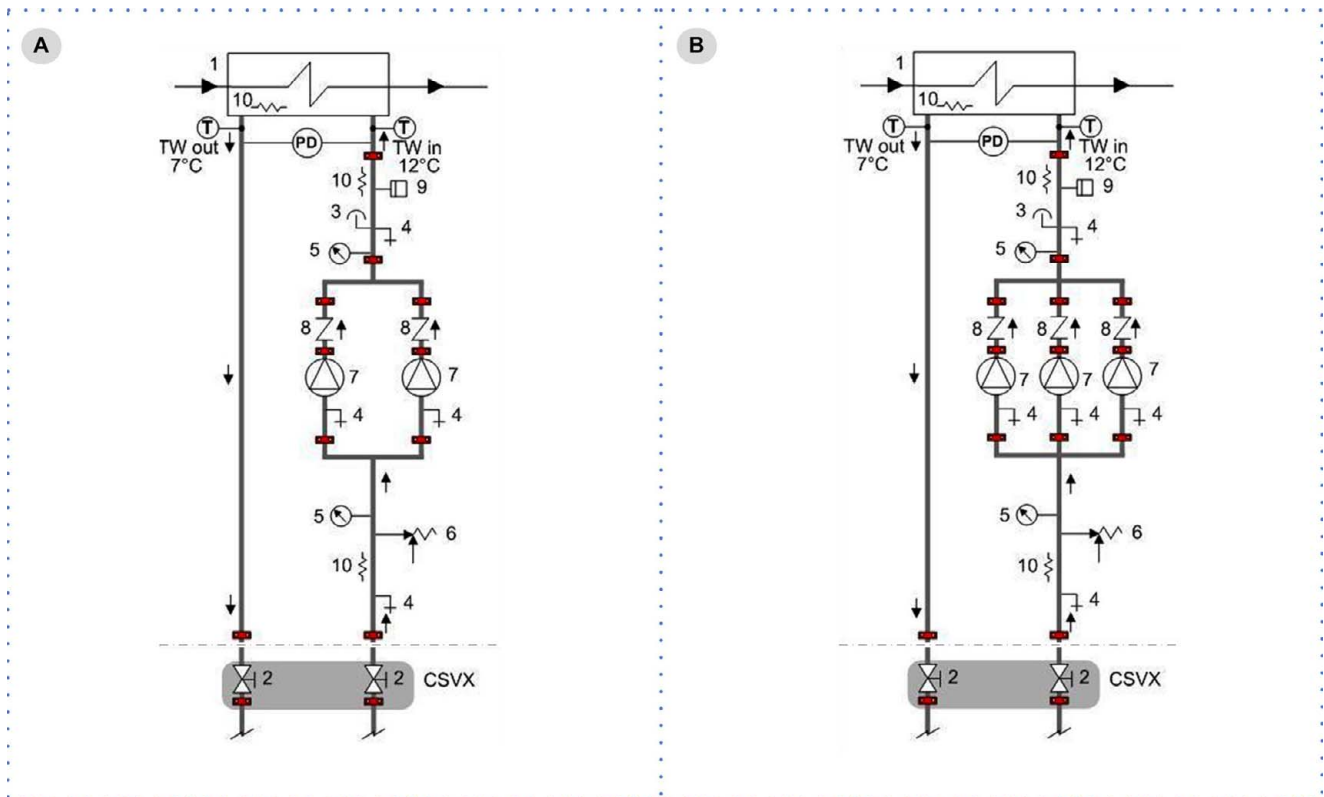

- A. Group with 2 pumps
- B. Group with 3 pumps

- 1. Internal exchanger
- 2. Cutoff valve
- 3. Purge valve
- 4. drain valve
- 5. Pressure gauge
- 6. Safety valve (6 Bar)
- 7. Packaged electric pump with high performance
- 8. non-return valve

- 9. System load safety pressure switch (it prevents the operation of the pumps in case of water lack)
- 10. Anti-ice electric heater

TW in chilled water inlet  
 TW out chilled water outlet

T - Temperature probe  
 PD - Differential pressure switch

CSVX - Couple of manually operated shut-off valves

## 10.4 Anti-vibration mount support

PE code

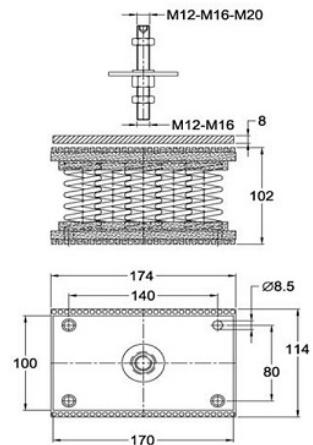
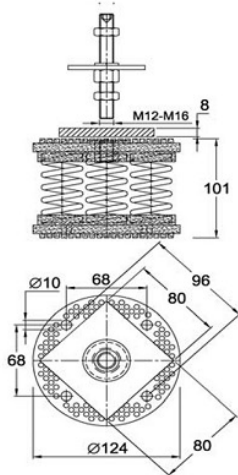
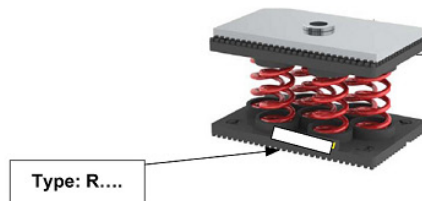
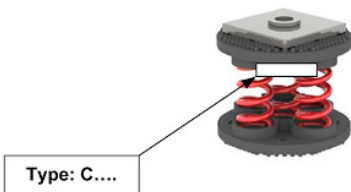

Brugola da 8  
Allen key 8<sup>th</sup>



Chiave del 24  
Simple key 24<sup>th</sup>



1

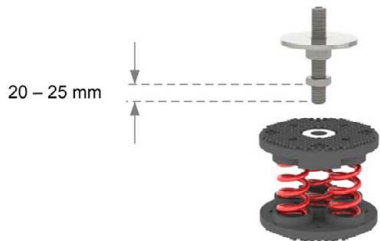

2



3



4



5



6



7



8



## 11 Decommissioning

### 11.1 Disconnecting

Only authorised personnel must disconnect the unit.

Avoid leak or spills into the environment.

Before disconnecting the unit, the following must be recovered, if present:

- refrigerant gas
- anti-freeze solutions in the water circuit

Awaiting dismantling and disposal, the unit can also be stored outdoors, if the electrical, cooling and water circuits of the unit have 100% integrity and are isolated, bad weather and rapid change in temperature will not result in any environmental impact.

### 11.2 Dismantling and disposal

The unit must always be sent to authorised centres for dismantling and disposal.

When dismantling the unit, the fan, the motor and the coil, if operating, may be recovered by the specialist centres for reuse.

All the materials must be recovered or disposed of in compliance with the corresponding national standards in force.

For further information on the decommissioning of the unit, contact the manufacturer.

### 11.3 Directive EC RAEE

The units covered by the legislation in question are marked with the symbol on the side.

With the aim of protecting the environment, all of our units are produced in compliance with Directive EC on waste electrical and electronic equipment (RAEE).

The potential effects on the environment and on human health due to the presence of hazardous substances are shown in the use and maintenance manual in the section on residual risks.

Information in addition to that indicated below, if required, can be obtained from the manufacturer/distributor/importer, who are responsible for the collection/handling of waste originating from equipment covered by EC-RAEE. This information is also available from the retailer who sold this appliance or from the local authorities who handle waste.

Directive EC-RAEE requires disposal and recycling of electrical and electronic equipment as described therein to be handled through appropriate collection, in suitable centres, separate from collection for the disposal of mixed urban waste.

The user must not dispose of the unit at the end of its life cycle as urban waste, it must instead be handed over to appropriate collection centres as set forth by current standards or as instructed by the distributor.



## 12 Residual risks

### General description

In this section the most common situations are indicated, as these cannot be controlled by the manufacturer and could be a source of risk situations for people or things.

#### Danger zone

This is an area in which only an authorised operator may work.

The danger zone is the area inside the unit which is accessible only with the deliberate removal of protections or parts thereof.

#### Handling

The handling operations, if implemented without all of the protection necessary and without due caution, may cause the drop or the tipping of the unit with the consequent damage, even serious, to persons, things or the unit itself.

Handle the unit following the instructions provided in the present manual regarding the packaging and in compliance with the local regulations in force. Should the refrigerant leak please refer to the refrigerant "Safety sheet".

#### Installation

The incorrect installation of the unit could cause water leaks, condensate accumulation, leaking of the refrigerant, electric shock, poor operation or damage to the unit itself.

Check that the installation has been implemented by qualified technical personnel only and that the instructions contained in the present manual and the local regulations in force have been adhered to.

The installation of the unit in a place where even infrequent leaks of inflammable gas and the accumulation of this gas in the area surrounding the area occur could cause explosions or fires.

Carefully check the positioning of the unit.

The installation of the unit in a place unsuited to support its weight and/or guarantee adequate anchorage may result in consequent damage to things, people or the unit itself.

Carefully check the positioning and the anchoring of the unit.

Easy access to the unit by children, unauthorised persons or animals may be the source of accidents, some serious.

Install the unit in areas which are only accessible to authorised person and/or provide protection against intrusion into the danger zone.

#### General risks

Smell of burning, smoke or other signals of serious anomalies may indicate a situation which could cause damage to people, things or the unit itself.

Electrically isolate the unit (yellow-red isolator).

Contact the authorised service centre to identify and resolve the problem at the source of the anomaly.

Accidental contact with exchange batteries, compressors, air delivery tubes or other components may cause injuries and/or burns.

Always wear suitable clothing including protective gloves to work inside the danger zone.

Maintenance and repair operations carried out by non-qualified personnel may cause damage to persons, things or the unit itself.

Always contact the qualified assistance centre.

Failing to close the unit panels or failure to check the correct tightening of all of the panelling fixing screws may cause damage to persons, things or the unit itself.

Periodically check that all of the panels are correctly closed and fixed.

If there is a fire the temperature of the refrigerant could reach values that increase the pressure to beyond the safety valve with the consequent possible projection of the refrigerant itself or explosion of the circuit parts that remain isolated by the closure of the tap.

Do not remain in the vicinity of the safety valve and never leave the refrigerant system taps closed.

### Electric parts

An incomplete attachment line to the electric network or with incorrectly sized cables and/or unsuitable protective devices can cause electric shocks, intoxication, damage to the unit or fires.

Carry out all of the work on the electric system referring to the electric layout and the present manual ensuring the use of a system thereto dedicated.

An incorrect fixing of the electric components cover may lead to the entry of dust, water etc inside and may consequently electric shocks, damage to the unit or fires.

Always fix the unit cover properly.

When the metallic mass of the unit is under voltage and is not correctly connected to the earthing system it may be as source of electric shock and electrocution.

Always pay particular attention to the implementation of the earthing system connections.

Contact with parts under voltage accessible inside the unit after the removal of the guards can cause electric shocks, burns and electrocution.

Open and padlock the general isolator prior to removing the guards and signal work in progress with the appropriate sign.

Contact with parts that could be under voltage due to the start up of the unit may cause electric shocks, burns and electrocution.

When voltage is necessary for the circuit open the isolator on the attachment line of the unit itself, padlock it and display the appropriate warning sign.

#### Moving parts

Contact with the transmissions or with the fan aspiration can cause injuries.

Prior to entering the inside of the unit open the isolator situated on the connection line of the unit itself, padlock and display the appropriate warning sign.

Contact with the fans can cause injury.

Prior to removing the protective grill or the fans, open the isolator on the attachment line of the unit itself, padlock it and display the appropriate warning sign.

#### Refrigerant

The intervention of the safety valve and the consequent expulsion of the gas refrigerant may cause injuries and intoxication.

Always wear suitable clothing including protective gloves and eyeglasses for operations inside the danger zone.

Should the refrigerant leak please refer to the refrigerant "Safety sheet".

Contact between open flames or heat sources with the refrigerant or the heating of the gas circuit under pressure (e.g. during welding operations) may cause explosions or fires.

Do not place any heat source inside the danger zone.

The maintenance or repair interventions which include welding must be carried out with the system off.

#### Hydraulic parts

Defects in tubing, the attachments or the removal parts may cause a leak or water projection with the consequent damages to people, things or shortcircuit the unit.



## EXCELLENCE VERSION

Acoustic configuration: standard (ST) / compressor soundproofing (SC)

### General technical data - Performance

Size			200.2	210.2	220.2	240.2	260.2	280.2	320.2	340.2	360.2	400.2	440.2	500.2	540.2	580.2
<b>Cooling</b>																
Cooling capacity	1	[kW]	486	510	550	585	637	709	783	839	902	979	1099	1218	1321	1430
Compressor power input	1	[kW]	141	149	158	168	186	204	224	241	260	286	325	352	387	415
Total power input	2	[kW]	154	162	173	184	202	223	244	264	283	311	351	383	418	447
Partial recovery heating capacity	3	[kW]	94,1	98,8	106	113	123	137	151	162	174	190	214	236	256	277
Total recovery heating capacity	3	[kW]	666	710	777	872	915	958	1028	1093	1206	1350	1405	1478	1613	1721
EER	1	-	3,15	3,15	3,17	3,18	3,15	3,18	3,21	3,18	3,19	3,15	3,13	3,18	3,16	3,20
Water flow-rate (User Side)	1	[l/s]	23,2	24,4	26,3	28,0	30,4	33,9	37,4	40,1	43,1	46,8	52,5	58,2	63,1	68,3
Internal exchanger pressure drops	1	[kPa]	42	46	32	36	42	51	53	60	68	27	33	57	66	76
Cooling capacity (EN14511:2013)	4	[kW]	484	508	549	583	635	706	780	835	898	977	1096	1213	1315	1423
Total power input (EN14511:2013)	4	[kW]	156	164	175	186	204	226	247	267	287	313	353	388	424	454
EER (EN 14511:2013)	4	-	3,10	3,10	3,14	3,14	3,11	3,13	3,16	3,13	3,13	3,12	3,10	3,13	3,10	3,13
ESEER	4	-	4,00	4,00	4,05	4,06	4,01	4,03	4,07	4,03	4,04	4,02	4,00	4,03	4,00	4,04
Cooling capacity (AHRI 550/590)	5	[kW]	483	506	546	580	632	703	777	830	889	971	1089	1209	1312	1419
Total power input (AHRI 550/590)	5	[kW]	154	161	173	183	201	223	243	262	280	310	350	383	417	446
COPR	5	-	3,14	3,14	3,16	3,16	3,14	3,16	3,19	3,16	3,17	3,13	3,11	3,16	3,15	3,18
IPLV	5	-	4,50	4,47	4,55	4,56	4,49	4,53	4,55	4,50	4,51	4,52	4,49	4,52	4,50	4,53

- Data referred to the following conditions: internal exchanger water = 12/7 °C. Entering external exchanger air temperature 35°C. Evaporator fouling factor =  $0.44 \times 10^{-4}$  m<sup>2</sup> K/W
- The Total Power Input value does not take into account the part related to the pumps and required to overcome the pressure drops for the circulation of the solution inside the exchangers
- Recovery exchanger water=40/45°C
- Data compliant to Standard EN 14511:2013 referred to the following conditions: - Internal exchanger water temperature = 12/7°C - Entering external exchanger air temperature = 35°C
- Data compliant to Standard AHRI 550/590 referred to the following conditions: internal exchanger water temperature = 6,7 °C. Water flow-rate 0,043 l/s per kW. Entering external exchanger air temperature 35°C. Evaporator fouling factor =  $0.18 \times 10^{-4}$  m<sup>2</sup> K/W

## PREMIUM VERSION

Acoustic configuration: standard (ST) / compressor soundproofing (SC)

### General technical data - Performance

Size			200.2	210.2	220.2	240.2	260.2	280.2	320.2	340.2	360.2	400.2	440.2	500.2	540.2	580.2
<b>Cooling</b>																
Cooling capacity	1	[kW]	468	490	514	560	601	668	744	785	837	916	1026	1142	1260	1359
Compressor power input	1	[kW]	148	158	168	180	200	225	245	262	286	314	354	390	433	450
Total power input	2	[kW]	160	171	181	193	213	241	261	281	305	333	377	413	458	476
Partial recovery heating capacity	3	[kW]	92,3	97,2	102	111	120	134	148	157	168	184	207	230	254	271
Total recovery heating capacity	3	[kW]	653	696	761	855	897	939	1007	1071	1182	1323	1377	1448	1581	1687
EER	1	-	2,92	2,87	2,84	2,90	2,83	2,78	2,85	2,79	2,74	2,75	2,72	2,77	2,75	2,86
Water flow-rate (User Side)	1	[l/s]	22,4	23,4	24,6	26,8	28,7	31,9	35,5	37,5	40,0	43,8	49,0	54,6	60,2	64,9
Internal exchanger pressure drops	1	[kPa]	31	33	37	47	53	46	55	61	60	70	29	36	61	70
Cooling capacity (EN14511:2013)	4	[kW]	467	489	512	558	599	666	741	781	833	912	1024	1139	1255	1353
Total power input (EN14511:2013)	4	[kW]	162	172	182	195	215	243	264	284	309	337	379	416	463	482
EER (EN 14511:2013)	4	-	2,89	2,84	2,81	2,86	2,79	2,74	2,80	2,75	2,70	2,70	2,70	2,74	2,71	2,81
ESEER	4	-	3,93	3,86	3,82	3,89	3,79	3,73	3,81	3,74	3,67	3,68	3,67	3,73	3,68	3,82
Cooling capacity (AHRI 550/590)	5	[kW]	458	481	506	551	595	663	735	779	833	907	1020	1135	1256	1342
Total power input (AHRI 550/590)	5	[kW]	159	169	180	192	212	239	260	279	302	331	376	411	458	474
COPR	5	-	2,88	2,84	2,81	2,87	2,80	2,77	2,83	2,79	2,76	2,74	2,72	2,76	2,74	2,83
IPLV	5	-	4,40	4,31	4,26	4,36	4,23	4,18	4,29	4,20	4,13	4,12	4,13	4,17	4,11	4,28

- Data referred to the following conditions: internal exchanger water = 12/7 °C. Entering external exchanger air temperature 35°C. Evaporator fouling factor =  $0.44 \times 10^{-4}$  m<sup>2</sup> K/W
- The Total Power Input value does not take into account the part related to the pumps and required to overcome the pressure drops for the circulation of the solution inside the exchangers
- Recovery exchanger water=40/45°C
- Data compliant to Standard EN 14511:2013 referred to the following conditions: - Internal exchanger water temperature = 12/7°C - Entering external exchanger air temperature = 35°C
- Data compliant to Standard AHRI 550/590 referred to the following conditions: internal exchanger water temperature = 6,7 °C. Water flow-rate 0,043 l/s per kW. Entering external exchanger air temperature 35°C. Evaporator fouling factor =  $0.18 \times 10^{-4}$  m<sup>2</sup> K/W

# EXCELLENCE VERSION

## Acoustic configuration: super-silenced (EN)

### General technical data - Performance

Size			200.2	210.2	220.2	240.2	260.2	280.2	320.2	340.2	360.2	400.2	440.2	500.2
<b>Cooling</b>														
Cooling capacity	1	kW	474	502	529	571	623	692	775	822	874	962	1066	1173
Compressor power input	1	kW	147	155	163	175	193	212	231	247	269	295	332	363
Total power input	2	kW	151	160	167	181	198	218	238	254	276	304	340	372
Partial recovery heating capacity	3	kW	93,1	98,6	104	112	122	136	151	160	171	189	210	230
Total recovery heating capacity	3	kW	666	710	777	872	915	958	1028	1093	1206	1350	1405	1478
EER	1		3,14	3,14	3,16	3,16	3,15	3,17	3,25	3,23	3,16	3,17	3,13	3,15
Water flow-rate (User Side)	1		22,6	24,0	25,3	27,3	29,8	33,1	37,0	39,3	41,8	46,0	50,9	56,0
Internal exchanger pressure drops	1		32	35	30	35	40	43	52	58	65	26	31	54
Cooling capacity (EN14511:2013)	4	kW	473	501	528	569	621	690	772	819	870	960	1063	1169
Total power input (EN14511:2013)	4	kW	152	161	169	182	200	220	241	258	280	306	343	377
EER (EN 14511:2013)	4	-	3,10	3,10	3,13	3,13	3,10	3,13	3,20	3,18	3,10	3,14	3,10	3,10
ESEER	4	-	4,12	4,13	4,16	4,16	4,13	4,16	4,26	4,22	4,13	4,18	4,13	4,13
Cooling capacity (AHRI 550/590)	5	kW	471	499	524	566	619	685	768	813	867	955	1057	1157
Total power input (AHRI 550/590)	5	kW	151	159	166	180	197	217	237	253	275	302	339	370
COPR	5	-	3,13	3,13	3,15	3,15	3,14	3,16	3,24	3,21	3,15	3,16	3,12	3,13
IPLV	5	-	4,64	4,61	4,65	4,64	4,63	4,65	4,75	4,73	4,61	4,69	4,62	4,63

- Data referred to the following conditions: internal exchanger water = 12/7 °C. Entering external exchanger air temperature 35°C. Evaporator fouling factor =  $0.44 \times 10^{-4}$  m<sup>2</sup> K/W
- The Total Power Input value does not take into account the part related to the pumps and required to overcome the pressure drops for the circulation of the solution inside the exchangers
- Recovery exchanger water=40/45°C
- Data compliant to Standard EN 14511:2013 referred to the following conditions: - Internal exchanger water temperature = 12/7°C - Entering external exchanger air temperature = 35°C
- Data compliant to Standard AHRI 550/590 referred to the following conditions: internal exchanger water temperature = 6,7 °C. Water flow-rate 0,043 l/s per kW. Entering external exchanger air temperature 35°C. Evaporator fouling factor =  $0.18 \times 10^{-4}$  m<sup>2</sup> K/W

# PREMIUM VERSION

## Acoustic configuration: super-silenced (EN)

### General technical data - Performance

Size			200.2	210.2	220.2	240.2	260.2	280.2	320.2	340.2	360.2	400.2	440.2	500.2	540.2	580.2
<b>Cooling</b>																
Cooling capacity	1	[kW]	448	469	504	533	593	656	723	772	829	903	1017	1134	1243	1316
Compressor power input	1	[kW]	160	168	174	191	209	228	250	269	291	319	353	396	432	464
Total power input	2	[kW]	164	172	178	195	214	233	255	275	297	325	361	405	441	473
Partial recovery heating capacity	3	[kW]	91,3	95,6	101,7	108,6	120,4	13,6	145,9	156,2	168	183,3	205,6	229,5	251,3	266,9
Total recovery heating capacity	3	[kW]	653	696	761	855	897	939	1007	1071	1182	1323	1377	1448	1581	1687
EER	1	-	2,73	2,73	2,83	2,74	2,77	2,82	2,83	2,81	2,79	2,77	2,82	2,80	2,82	2,78
Water flow-rate (User Side)	1	[l/s]	21,4	22,4	24,1	25,5	28,3	31,3	34,5	36,9	39,6	43,1	48,6	54,2	59,4	62,9
Internal exchanger pressure drops	1	[kPa]	28	31	35	43	52	44	52	61	54	61	29	35	60	66
Cooling capacity (EN14511:2013)	4	[kW]	447	468	503	531	591	654	720	769	826	899	1015	1131	1238	1310
Total power input (EN14511:2013)	4	[kW]	165	173	179	197	216	235	258	278	300	329	363	408	446	478
EER (EN 14511:2013)	4	-	2,70	2,70	2,80	2,70	2,73	2,78	2,79	2,76	2,75	2,73	2,80	2,78	2,77	2,74
ESEER	4	-	3,73	3,68	3,84	3,73	3,77	3,81	3,85	3,79	3,74	3,76	3,80	3,83	3,77	3,78
Cooling capacity (AHRI 550/590)	5	[kW]	445	461	497	528	587	649	720	764	821	894	1009	1124	1221	1292
Total power input (AHRI 550/590)	5	[kW]	164	170	177	194	213	231	255	273	296	323	359	401	437	468
COPR	5	-	2,72	2,71	2,81	2,73	2,76	2,80	2,83	2,80	2,77	2,76	2,81	2,80	2,79	2,76
IPLV	5	-	4,19	4,13	4,30	4,18	4,24	4,26	4,30	4,26	4,19	4,23	4,25	4,29	4,24	4,24

- Data referred to the following conditions: internal exchanger water = 12/7 °C. Entering external exchanger air temperature 35°C. Evaporator fouling factor =  $0.44 \times 10^{-4}$  m<sup>2</sup> K/W
- The Total Power Input value does not take into account the part related to the pumps and required to overcome the pressure drops for the circulation of the solution inside the exchangers
- Recovery exchanger water=40/45°C
- Data compliant to Standard EN 14511:2013 referred to the following conditions: - Internal exchanger water temperature = 12/7°C - Entering external exchanger air temperature = 35°C
- Data compliant to Standard AHRI 550/590 referred to the following conditions: internal exchanger water temperature = 6,7 °C. Water flow-rate 0,043 l/s per kW. Entering external exchanger air temperature 35°C. Evaporator fouling factor =  $0.18 \times 10^{-4}$  m<sup>2</sup> K/W

# VERSION: EXCELLENCE

## Acoustic configuration: standard (ST) / compressor soundproofing (SC)

### General technical data - Construction

Size		200.2	210.2	220.2	240.2	260.2	280.2	320.2	340.2	360.2	400.2	440.2	500.2	540.2	580.2	
<b>Compressor</b>																
Type of compressors	1	-	DSW	DSW	DSW	DSW	DSW	DSW	DSW	DSW	DSW	DSW	DSW	DSW	DSW	DSW
No. of compressors		-	2	2	2	2	2	2	2	2	2	2	2	2	2	2
Rated power (C1)		[HP]	100	100	110	120	120	140	160	160	180	200	220	250	270	290
Nominal capacity (C2)		[HP]	100	110	110	120	140	140	160	180	180	200	220	250	270	290
Std Capacity control steps	6		25-100%	25-100%	25-100%	25-100%	25-100%	25-100%	25-100%	25-100%	25-100%	25-100%	25-100%	25-100%	25-100%	25-100%
Oil charge (C1)		[l]	17	17	17	17	17	21	21	21	25	25	25	25	30	30
Oil charge (C2)		[l]	17	17	17	17	21	21	21	25	25	25	25	25	30	30
Refrigerant charge (C1)		[kg]	55	55	62	66	66	81	82	75	89	105	110	133	137	138
Refrigerant charge (C2)		[kg]	59	59	66	70	74	87	87	95	105	110	118	141	145	146
Refrigeration circuits		-	2	2	2	2	2	2	2	2	2	2	2	2	2	2
<b>Internal exchanger</b>																
Type of internal exchanger	2	-	S&T	S&T	S&T	S&T	S&T	S&T	S&T	S&T	S&T	S&T	S&T	S&T	S&T	S&T
N. of internal exchanger		-	1	1	1	1	1	1	1	1	1	1	1	1	1	1
Water content		[l]	222	222	307	307	307	280	280	280	280	481	481	514	514	514
<b>External exchanger</b>																
Frontal surface		m <sup>2</sup>	18,7	18,7	23,4	23,4	23,4	28,1	28,1	32,8	32,8	37,4	37,4	46,8	46,8	46,8
<b>External Section Fans</b>																
Type of fans	3	-	AX	AX	AX	AX	AX	AX	AX	AX	AX	AX	AX	AX	AX	AX
Number of fans		-	8	8	10	10	10	12	12	14	14	16	16	20	20	20
Type of motor	4	-	AC/P	AC/P	AC/P	AC/P	AC/P	AC/P	AC/P	AC/P	AC/P	AC/P	AC/P	AC/P	AC/P	AC/P
Standard airflow		[l/s]	48000	48000	61000	60000	59000	72000	70000	84000	82000	97000	94000	123000	121000	117000
<b>Connections</b>																
Water fittings		-	8"	8"	6"	6"	6"	6"	6"	6"	6"	8"	8"	8"	8"	8"
<b>Power supply</b>																
Standard power supply		-	400/3~/50	400/3~/50	400/3~/50	400/3~/50	400/3~/50	400/3~/50	400/3~/50	400/3~/50	400/3~/50	400/3~/50	400/3~/50	400/3~/50	400/3~/50	400/3~/50
<b>Electrical data</b>																
FLA Total		A	370	388	414	440	489	546	600	648	687	751	819	916	982	1047
FLI Total		kW	225	236	251	268	292	321	353	381	405	442	493	545	594	634
M.I.C. - Value	5	A	356	409	427	436	432	473	559	657	687	712	809	956	1096	1253
M.I.C. - with soft start accessory	5	A	517	598	616	630	615	656	786	978	1008	1034	1168	1380	1669	1853

1. DSW = double screw compressor
2. S&T = shell and tube
3. AX = axial fan
4. AC/P = asynchronous three-phase external rotor motor with phase cutting speed automatic control

Unbalance between phase max 2% +/- 10%  
Voltage variation: max +/- 10%  
Electrical data refer to standard units; according to the installed accessories, the data can suffer some variations..

5. M.I.C. = compressor 2 starting current + compressor 1 current at 75% of the max load + circuit 1 fan
6. The unit is able to modulate STEPLESS continuously. The following data refers to a continuous operation of the unit. During start-up and stop, each compressor is able to modulate up to 25% of its capacity

### Sound levels - ST configuration

Size	Sound power level (dB)								Sound power level dB(A)	Sound pressure level dB(A)
	Octave band (Hz)									
	63	125	250	500	1000	2000	4000	8000		
200.2	107	98	90	95	100	75	77	72	101	81
210.2	107	99	94	94	100	76	77	72	101	81
220.2	108	100	97	94	100	77	78	74	101	81
240.2	108	100	96	96	100	78	79	74	101	81
260.2	108	99	95	95	100	83	83	75	101	80
280.2	110	100	94	96	100	86	86	76	101	80
320.2	110	100	94	96	100	86	86	76	101	80
340.2	111	101	96	97	101	88	87	77	103	81
360.2	111	101	97	98	102	88	87	78	104	82
400.2	112	102	99	97	104	87	86	78	105	83
440.2	112	102	96	104	106	87	86	78	107	85
500.2	113	103	97	96	107	91	89	79	108	86
540.2	113	103	100	96	109	88	90	79	109	87
580.2	113	103	97	98	109	91	89	79	109	87

### Sound levels - SC configuration

Size	Sound power level (dB)								Sound power level dB(A)	Sound pressure level dB(A)
	Octave band (Hz)									
	63	125	250	500	1000	2000	4000	8000		
200.2	107	98	86	92	97	73	76	72	98	77
210.2	107	98	90	92	97	74	76	72	98	77
220.2	108	99	92	92	97	75	77	74	98	77
240.2	108	99	91	94	97	76	77	74	98	77
260.2	108	99	90	93	96	81	79	74	98	77
280.2	110	100	90	94	96	84	81	75	98	77
320.2	110	100	90	94	97	84	81	75	98	77
340.2	111	101	91	95	98	85	82	76	100	78
360.2	111	101	92	96	99	86	82	76	100	79
400.2	112	102	95	95	101	84	82	77	102	80
440.2	112	102	92	101	102	85	82	77	104	82
500.2	113	103	92	95	104	89	84	78	105	82
540.2	113	103	96	94	105	86	85	78	106	83
580.2	113	103	92	96	105	89	84	78	106	83

Sound levels refer to full load units, in test nominal conditions. The sound pressure level refers to 1 m. from the standard unit outer surface operating in open field. Measures according to UNI EN ISO 9614-2 regulations, with respect to the EUROVENT 8/1 certification. Data referred to the following conditions. - internal exchanger water = 12/7 °C - Ambient temperature = 35 °C

# VERSION: PREMIUM

## Acoustic configuration: standard (ST) / compressor soundproofing (SC)

### General technical data - Construction

Size		200.2	210.2	220.2	240.2	260.2	280.2	320.2	340.2	360.2	400.2	440.2	500.2	540.2	580.2	
<b>Compressor</b>																
Type of compressors	1	-	DSW	DSW	DSW	DSW	DSW	DSW	DSW	DSW	DSW	DSW	DSW	DSW	DSW	DSW
No. of compressors		-	2	2	2	2	2	2	2	2	2	2	2	2	2	2
Rated power (C1)		[HP]	100	100	110	120	120	140	160	160	180	200	220	250	270	290
Nominal capacity (C2)		[HP]	100	110	110	120	140	140	160	180	180	200	220	250	270	290
Std Capacity control steps	6		25-100%	25-100%	25-100%	25-100%	25-100%	25-100%	25-100%	25-100%	25-100%	25-100%	25-100%	25-100%	25-100%	25-100%
Oil charge (C1)		[l]	17	17	17	17	17	21	21	21	25	25	25	25	30	30
Oil charge (C2)		[l]	17	17	17	17	21	21	21	25	25	25	25	25	30	30
Refrigerant charge (C1)		[kg]	52	52	52	56	56	67	70	70	75	83	98	98	115	116
Refrigerant charge (C2)		[kg]	55	55	55	59	65	73	75	80	80	88	106	106	123	124
Refrigeration circuits		-	2	2	2	2	2	2	2	2	2	2	2	2	2	2
<b>Internal exchanger</b>																
Type of internal exchanger	2	-	S&T	S&T	S&T	S&T	S&T	S&T	S&T	S&T	S&T	S&T	S&T	S&T	S&T	S&T
N. of internal exchanger		-	1	1	1	1	1	1	1	1	1	1	1	1	1	1
Water content		[l]	238	238	238	233	233	280	280	280	280	280	481	481	514	514
<b>External exchanger</b>																
Frontal surface		m <sup>2</sup>	18,7	18,7	18,7	18,7	18,7	23,4	23,4	28,1	28,1	28,1	32,8	32,8	37,4	37,4
<b>External Section Fans</b>																
Type of fans	3	-	AX	AX	AX	AX	AX	AX	AX	AX	AX	AX	AX	AX	AX	AX
Number of fans		-	8	8	8	8	8	10	10	12	12	12	14	14	16	16
Type of motor	4		AC/P	AC/P	AC/P	AC/P	AC/P	AC/P	AC/P	AC/P	AC/P	AC/P	AC/P	AC/P	AC/P	AC/P
Standard airflow		[l/s]	49000	49000	49000	48000	50000	61000	60000	74000	74000	72000	85000	82000	97000	94000
<b>Connections</b>																
Water fittings		-	8"	8"	8"	8"	8"	6"	6"	6"	6"	6"	8"	8"	8"	8"
<b>Power supply</b>																
Standard power supply		V	400/3~/50	400/3~/50	400/3~/50	400/3~/50	400/3~/50	400/3~/50	400/3~/50	400/3~/50	400/3~/50	400/3~/50	400/3~/50	400/3~/50	400/3~/50	400/3~/50
<b>Electrical data</b>																
FLA Total		A	370	388	406	432	480	537	591	639	679	735	811	892	966	1031
FLI Total		kW	225	236	248	263	288	317	349	377	401	435	490	534	586	626
M.I.C. - Value	5	A	356	409	423	432	428	469	555	653	683	704	805	944	1088	1245
M.I.C. - with soft start accessory	5	A	517	598	612	626	611	652	782	974	1004	1026	1164	1368	1661	1845

- DSW = double screw compressor
- S&T = shell and tube
- AX = axial fan
- AC/P = asynchronous three-phase external rotor motor with phase cutting speed automatic control

Unbalance between phase max 2% +/- 10%  
Voltage variation: max +/- 10%  
Electrical data refer to standard units; according to the installed accessories, the data can suffer some variations..

- M.I.C. = compressor 2 starting current + compressor 1 current at 75% of the max load + circuit 1 fan
- The unit is able to modulate STEPLESS continuously. The following data refers to a continuous operation of the unit. During start-up and stop, each compressor is able to modulate up to 25% of its capacity

### Sound levels - ST configuration

Size	Sound power level (dB)								Sound power level dB(A)	Sound pressure level dB(A)
	Octave band (Hz)									
	63	125	250	500	1000	2000	4000	8000		
200.2	107	98	90	95	100	75	77	72	101	81
210.2	107	99	94	94	100	76	77	72	101	81
220.2	107	99	96	94	100	77	77	72	101	80
240.2	107	99	95	95	100	77	78	73	101	81
260.2	107	98	94	95	99	83	82	74	101	80
280.2	108	99	93	95	99	85	85	75	101	80
320.2	108	99	93	95	99	86	85	76	101	80
340.2	110	100	95	97	101	87	86	77	102	81
360.2	110	100	96	98	102	88	87	77	103	82
400.2	110	100	98	96	104	86	86	76	104	83
440.2	111	101	96	103	105	86	86	77	107	85
500.2	111	101	95	95	106	90	88	77	107	85
540.2	112	102	99	95	108	88	89	78	109	87
580.2	112	102	96	98	108	90	89	78	109	87

### Sound levels - SC configuration

Size	Sound power level (dB)								Sound power level dB(A)	Sound pressure level dB(A)
	Octave band (Hz)									
	63	125	250	500	1000	2000	4000	8000		
200.2	108	98	86	93	97	74	76	73	98	77
210.2	108	98	90	92	97	74	76	73	98	77
220.2	108	99	91	92	96	75	76	73	98	77
240.2	108	98	91	93	96	76	77	73	98	77
260.2	108	98	90	93	96	80	78	73	97	77
280.2	109	99	89	93	96	83	80	74	98	77
320.2	109	99	89	93	96	83	80	74	98	77
340.2	110	100	91	95	98	85	82	76	99	78
360.2	110	100	92	96	98	86	82	76	100	79
400.2	110	100	94	94	100	84	81	75	101	80
440.2	111	101	92	101	102	84	82	77	104	82
500.2	111	101	91	94	103	88	83	76	104	82
540.2	112	102	95	93	105	86	84	77	105	83
580.2	112	102	92	96	104	88	84	77	105	83

Sound levels refer to full load units, in test nominal conditions. The sound pressure level refers to 1 m. from the standard unit outer surface operating in open field. Measures according to UNI EN ISO 9614-2 regulations, with respect to the EUROVENT 8/1 certification. Data referred to the following conditions. - internal exchanger water = 12/7 °C - Ambient temperature = 35 °C

# EXCELLENCE VERSION

## Acoustic configuration: super-silenced (EN)

### General technical data - Construction

Size		200.2	210.2	220.2	240.2	260.2	280.2	320.2	340.2	360.2	400.2	440.2	500.2
<b>Compressor</b>													
Type of compressors	1	-	DSW	DSW	DSW	DSW	DSW	DSW	DSW	DSW	DSW	DSW	DSW
No. of compressors		No	2	2	2	2	2	2	2	2	2	2	2
Rated power (C1)		[HP]	100	100	110	120	120	140	160	160	180	200	250
Nominal capacity (C2)		[HP]	100	110	110	120	140	140	160	180	180	200	250
Std Capacity control steps	6		25-100%	25-100%	25-100%	25-100%	25-100%	25-100%	25-100%	25-100%	25-100%	25-100%	25-100%
Oil charge (C1)		[l]	17	17	17	17	17	21	21	21	25	25	25
Oil charge (C2)		[l]	17	17	17	17	21	21	21	25	25	25	25
Refrigerant charge (C1)		[kg]	60	60	64	73	75	88	99	99	100	122	136
Refrigerant charge (C2)		[kg]	63	63	67	76	82	93	105	105	105	128	144
Refrigeration circuits		-	2	2	2	2	2	2	2	2	2	2	2
<b>Internal exchanger</b>													
Type of internal exchanger	2	-	S&T	S&T	S&T	S&T	S&T	S&T	S&T	S&T	S&T	S&T	S&T
N. of internal exchanger		No	1	1	1	1	1	1	1	1	1	1	1
Water content		[l]	255	255	307	307	307	280	280	280	280	481	514
<b>External exchanger</b>													
Frontal surface		m <sup>2</sup>	18.7	18.7	23.4	23.4	23.4	28.1	28.1	32.8	32.8	37.4	46.8
<b>External Section Fans</b>													
Type of fans	3	-	AX	AX	AX	AX	AX	AX	AX	AX	AX	AX	AX
Number of fans		Nr	10	10	10	12	12	14	16	16	16	20	20
Type of motor	4	-	EC	EC	EC	EC	EC	EC	EC	EC	EC	EC	EC
Standard airflow		[l/s]	39696	39484	39272	47636	46210	54981	62835	61613	60392	79392	78544
<b>Connections</b>													
Water fittings		-	6"	6"	6"	6"	6"	6"	8"	8"	8"	8"	10"
<b>Power supply</b>													
Standard power supply		V	400/3~/50	400/3~/50	400/3~/50	400/3~/50	400/3~/50	400/3~/50	400/3~/50	400/3~/50	400/3~/50	400/3~/50	400/3~/50
<b>Electrical data</b>													
FLA Total		A	359	377	396	426	474	528	586	626	666	730	879
FLI Total		kW	221	233	244	263	287	315	349	373	397	435	531
M.I.C. - Value	5	A	351	404	417	429	425	464	552	646	676	702	937
M.I.C. - with soft start accessory	5	A	511	592	606	623	608	647	779	967	997	1024	1361

1. DSW = double screw compressor
2. S&T = shell and tube
3. AX = axial fan
4. AC/P = asynchronous three-phase external rotor motor with phase cutting speed automatic control

Unbalance between phase max 2% Voltage variation: max +/- 10%  
 Electrical data refer to standard units; according to the installed accessories, the data can suffer some variations.

5. M.I.C. = compressor 2 starting current + compressor 1 current at 75% of the max load + circuit 1 fan
6. The unit is able to modulate STEPLESS continuously. The following data refers to a continuous operation of the unit. During start-up and stop, each compressor is able to modulate up to 25% of its capacity

### Sound levels

Size	Sound power level (dB)								Sound power level dB(A)	Sound pressure level dB(A)
	Octave band (Hz)									
	63	125	250	500	1000	2000	4000	8000		
200.2	96	90	81	89	93	68	66	61	94	73
210.2	96	90	85	88	93	69	66	61	94	73
220.2	96	90	88	88	93	70	66	61	94	73
240.2	97	91	87	90	93	71	68	62	94	73
260.2	97	90	86	89	93	77	72	63	94	73
280.2	98	89	85	90	92	80	74	64	94	72
320.2	99	90	85	90	93	80	75	65	94	73
340.2	99	90	87	91	94	81	76	65	95	74
360.2	99	90	88	92	95	82	76	65	96	74
400.2	100	92	91	91	97	81	76	66	98	76
440.2	100	92	88	98	99	81	75	66	100	78
500.2	100	92	87	90	100	84	78	66	100	78

Sound levels refer to full load units, in test nominal conditions. The sound pressure level refers to 1 m. from the standard unit outer surface operating in open field. Measures according to UNI EN ISO 9614-2 regulations, with respect to the EUROVENT 8/1 certification. Data referred to the following conditions. - internal exchanger water = 12/7 °C - Ambient temperature = 35 °C

# PREMIUM VERSION

## Acoustic configuration: super-silenced (EN)

### General technical data - Construction

Size		200.2	210.2	220.2	240.2	260.2	280.2	320.2	340.2	360.2	400.2	440.2	500.2	540.2	580.2	
<b>Compressor</b>																
Type of compressors	1	-	DSW	DSW	DSW	DSW	DSW	DSW	DSW	DSW	DSW	DSW	DSW	DSW	DSW	DSW
No. of compressors		No	2	2	2	2	2	2	2	2	2	2	2	2	2	2
Rated power (C1)		[HP]	100	100	110	120	120	140	160	160	180	200	220	250	270	290
Nominal capacity (C2)		[HP]	100	110	110	120	140	140	160	180	180	200	220	250	270	290
Std Capacity control steps	6		25-100%	25-100%	25-100%	25-100%	25-100%	25-100%	25-100%	25-100%	25-100%	25-100%	25-100%	25-100%	25-100%	25-100%
Oil charge (C1)		[l]	17	17	17	17	17	21	21	21	25	25	25	25	30	30
Oil charge (C2)		[l]	17	17	17	17	21	21	21	25	25	25	25	25	30	30
Refrigerant charge (C1)		[kg]	52	52	53	56	61	69	78	78	89	89	110	129	137	138
Refrigerant charge (C2)		[kg]	55	56	56	59	69	74	83	88	95	95	118	137	145	146
Refrigeration circuits		-	2	2	2	2	2	2	2	2	2	2	2	2	2	2
<b>Internal exchanger</b>																
Type of internal exchanger	2	-	S&T	S&T	S&T	S&T	S&T	S&T	S&T	S&T	S&T	S&T	S&T	S&T	S&T	S&T
N. of internal exchanger		No	1	1	1	1	1	1	1	1	1	1	1	1	1	1
Water content		[l]	238	238	238	233	255	280	280	280	280	280	481	481	514	514
<b>External exchanger</b>																
Frontal surface		m <sup>2</sup>	18.7	18.7	18.7	18.7	23.4	23.4	28.1	28.1	32.8	32.8	37.4	46.8	46.8	46.8
<b>External Section Fans</b>																
Type of fans	3	-	AX	AX	AX	AX	AX	AX	AX	AX	AX	AX	AX	AX	AX	AX
Number of fans		No	8	8	8	8	10	10	12	12	14	14	16	20	20	20
Type of motor	4	-	EC	EC	EC	EC	EC	EC	EC	EC	EC	EC	EC	EC	EC	EC
Standard airflow		[l/s]	32000	32000	30000	30000	39000	38000	47000	45000	55000	53000	60000	79000	78000	75000
<b>Connections</b>																
Water fittings		-	8"	8"	8"	8"	6"	6"	6"	6"	6"	6"	8"	8"	8"	8"
<b>Power supply</b>																
Standard power supply		V	400/3~/50	400/3~/50	400/3~/50	400/3~/50	400/3~/50	400/3~/50	400/3~/50	400/3~/50	400/3~/50	400/3~/50	400/3~/50	400/3~/50	400/3~/50	400/3~/50
<b>Electrical data</b>																
FLA Total		A	355	373	391	417	470	519	577	617	661	717	789	879	945	1010
FLI Total		kW	219	230	242	258	285	310	344	368	395	428	482	531	579	619
M.I.C. - Value	5	A	348	401	415	425	423	460	548	642	674	695	794	937	1077	1234
M.I.C. - with soft start accessory	5	A	509	590	604	619	606	643	775	963	995	1017	1153	1361	1650	1834

1. DSW = double screw compressor
2. S&T = shell and tube
3. AX = axial fan
4. AC/P = asynchronous three-phase external rotor motor with phase cutting speed automatic control

Unbalance between phase max 2 % Voltage variation: max +/- 10%  
 Electrical data refer to standard units; according to the installed accessories, the data can suffer some variations.

5. M.I.C. = compressor 2 starting current + compressor 1 current at 75% of the max load + circuit 1 fan
6. The unit is able to modulate STEPLESS continuously. The following data refers to a continuous operation of the unit. During start-up and stop, each compressor is able to modulate up to 25% of its capacity

### Sound levels

Size	Sound power level (dB)								Sound power level dB(A)	Sound pressure level dB(A)
	Octave band (Hz)									
	63	125	250	500	1000	2000	4000	8000		
200.2	95	90	82	89	93	69	66	61	94	74
210.2	95	90	86	89	93	70	66	61	94	74
220.2	95	91	88	88	93	71	66	60	94	74
240.2	95	91	87	90	93	72	67	61	94	74
260.2	97	90	87	90	93	78	72	63	94	74
280.2	97	89	85	90	93	80	75	63	94	73
320.2	98	89	86	90	93	80	75	64	95	74
340.2	98	90	87	91	94	82	76	64	96	75
360.2	99	91	89	93	96	83	77	65	97	75
400.2	99	91	91	91	98	81	75	65	98	77
440.2	100	92	88	98	99	81	75	66	101	79
500.2	101	93	88	91	101	85	79	67	101	79
540.2	101	93	92	90	102	83	79	67	102	80
580.2	101	94	88	93	102	86	79	67	102	80

Sound levels refer to full load units, in test nominal conditions. The sound pressure level refers to 1 m. from the standard unit outer surface operating in open field. Measures according to UNI EN ISO 9614-2 regulations, with respect to the EUROVENT 8/1 certification. Data referred to the following conditions. - internal exchanger water = 12/7 °C - Ambient temperature = 35 °C

# Operating range

## EXCELLENCE VERSION

### Acoustic configuration: standard (ST) / Compressor soundproofing (SC)

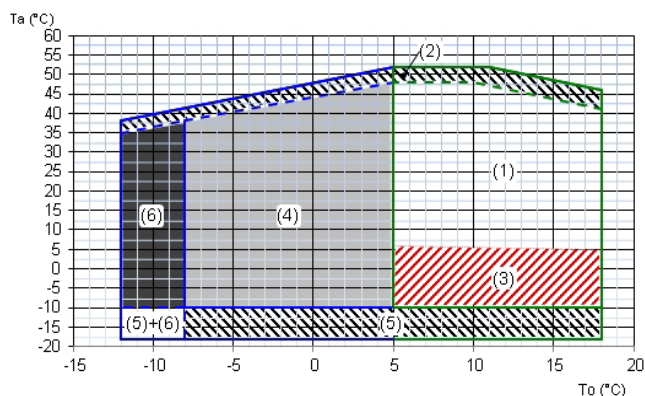

Ta (°C) = external exchanger inlet air temperature (D.B.)  
To (°C) = internal exchanger outlet water temperature

1. Standard unit operating range at full load
2. Unit operating range with automatic staging of the compressor capacity
3. Standard unit operating range with air flow automatic modulation
4. Unit operating range in 'B - Low water temperature' configuration (40% ethylene glycol)
5. Unit operating range with 'REGBT - device for the condensing coil partialization'
6. Extended of operating range (extremely low water temperature option available on request)

### Acoustic configuration: super-silenced (EN)

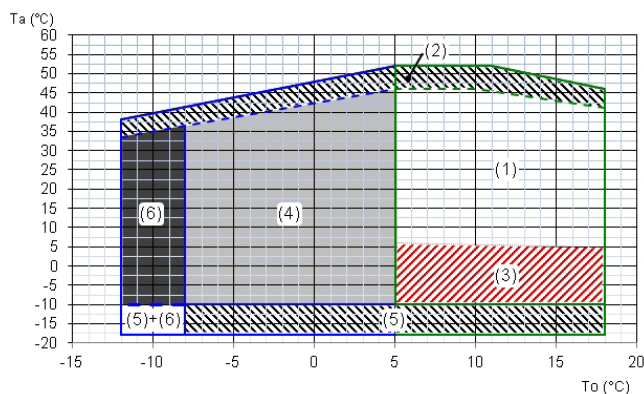

Ta (°C) = external exchanger inlet air temperature (D.B.)  
To (°C) = internal exchanger outlet water temperature

1. Standard unit operating range at full load
2. Unit operating range with automatic staging of the compressor capacity
3. Standard unit operating range with air flow automatic modulation
4. Unit operating range in 'B - Low water temperature' configuration (40% ethylene glycol)
5. Unit operating range with 'REGBT - device for the condensing coil partialization'
6. Extended of operating range (extremely low water temperature option available on request)

## PREMIUM VERSION

### Acoustic configuration: standard (ST) / Compressor soundproofing (SC)

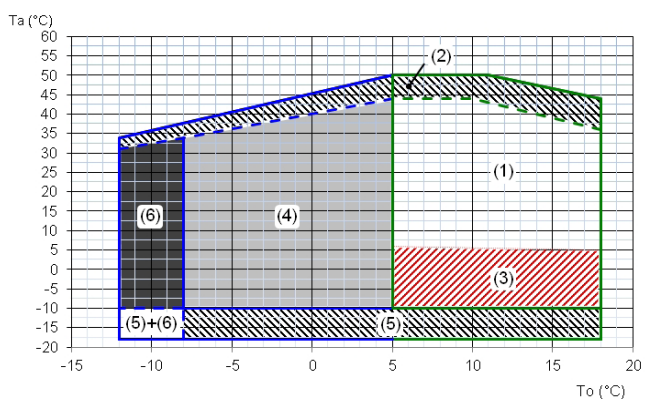

Ta (°C) = external exchanger inlet air temperature (D.B.)  
To (°C) = internal exchanger outlet water temperature

1. Standard unit operating range at full load
2. Unit operating range with automatic staging of the compressor capacity
3. Standard unit operating range with air flow automatic modulation
4. Unit operating range in 'B - Low water temperature' configuration (40% ethylene glycol)
5. Unit operating range with 'REGBT - device for the condensing coil partialization'
6. Extended of operating range (extremely low water temperature option available on request)

### Acoustic configuration: super-silenced (EN)

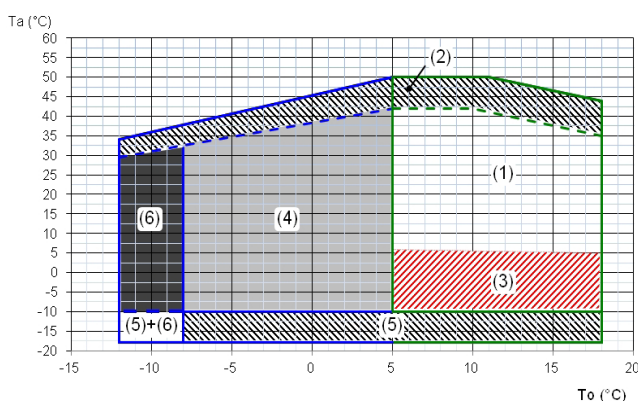

Ta (°C) = external exchanger inlet air temperature (D.B.)  
To (°C) = internal exchanger outlet water temperature

1. Standard unit operating range at full load
2. Unit operating range with automatic staging of the compressor capacity
3. Standard unit operating range with air flow automatic modulation
4. Unit operating range in 'B - Low water temperature' configuration (40% ethylene glycol)
5. Unit operating range with 'REGBT - device for the condensing coil partialization'
6. Extended of operating range (extremely low water temperature option available on request)

## Admissible water flow-rates

Minimum (Qmin) and maximum (Qmax) admissible water flow for the unit to operate correctly.

EXCELLENCE ST/SC		200.2	210.2	220.2	240.2	260.2	280.2	320.2	340.2	360.2	400.2	440.2	500.2	540.2	580.2
Qmin	[l/s]	15.3	15.3	20.1	20.1	20.1	21.6	21.6	21.6	21.6	39.4	39.4	32.3	32.3	32.3
Qmax	[l/s]	37.3	37.3	45.2	45.2	45.2	53.4	53.4	53.4	53.4	86.6	86.6	72.5	72.5	72.5

PREMIUM ST/SC		200.2	210.2	220.2	240.2	260.2	280.2	320.2	340.2	360.2	400.2	440.2	500.2	540.2	580.2
Qmin	[l/s]	17.7	17.7	17.7	16.7	16.7	20.1	20.1	20.1	21.6	21.6	39.4	39.4	32.3	32.3
Qmax	[l/s]	37.7	37.7	37.7	37.2	37.2	45.2	45.2	45.2	53.4	53.4	86.6	86.6	72.5	72.5

EXCELLENCE EN		200.2	210.2	220.2	240.2	260.2	280.2	320.2	340.2	360.2	400.2	440.2	500.2
Qmin	[l/s]	17.5	17.5	20.1	20.1	20.1	21.6	21.6	21.6	21.6	39.4	39.4	32.3
Qmax	[l/s]	37.9	37.9	45.2	45.2	45.2	53.4	53.4	53.4	53.4	86.6	86.6	72.5

PREMIUM EN		200.2	210.2	220.2	240.2	260.2	280.2	320.2	340.2	360.2	400.2	440.2	500.2	540.2	580.2
Qmin	[l/s]	17.7	17.7	17.7	16.7	17.5	20.1	20.1	20.1	21.6	21.6	39.4	39.4	32.3	32.3
Qmax	[l/s]	37.7	37.7	37.7	37.2	39.2	45.2	45.2	45.2	53.4	53.4	86.6	86.6	72.5	72.5

## Exchanger operating range

	Internal exchanger	
	DPr	DPw
PED (CE)	2450	1050

DPr = Maximum operating pressure on refrigerant side in kPa

DPw = Maximum operating pressure on water side in kPa

## Overload and control device calibrations

		open	closed	value
High pressure switch	[kPa]	2100	1550	–
Antifreeze protection	[°C]	3	5.5	–
High pressure safety valve	[kPa]	–	–	2500
Low pressure safety valve	[kPa]	–	–	1650
Max no. of compressor starts per hour	[n°]	–	–	6
Discharge safety thermostat	[°C]	–	–	120



# Dimensional drawings - EXCELLENCE version

Size 200.2-210.2 - Acoustic configuration: standard (ST) / Compressor soundproofing (SC)

DAA8E200 2\_210 2\_EXC\_ST\_SC\_0

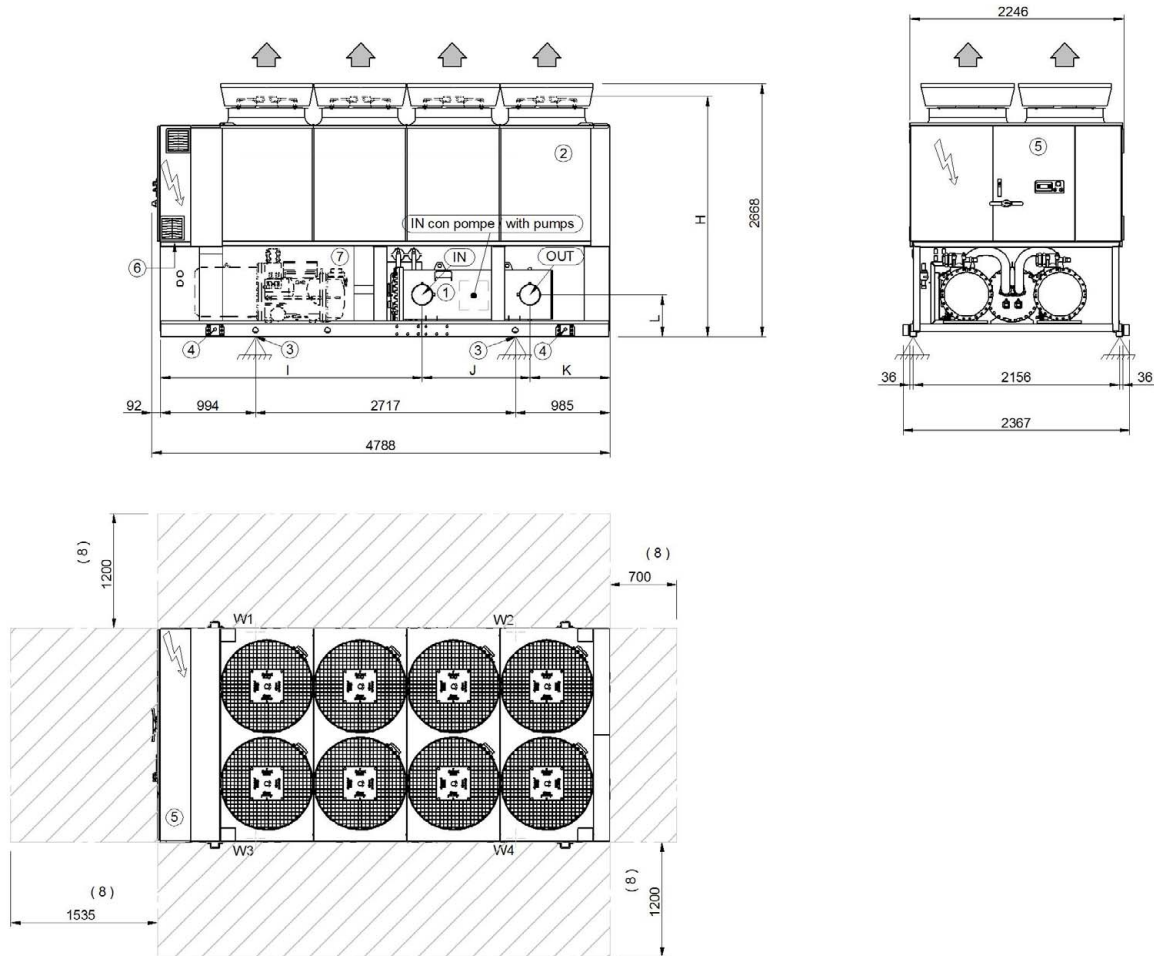

- 1. Internal exchanger (evaporator)
- 2. External exchanger (condenser)
- 3. Unit fixing holes
- 4. Lifting brackets (removable, if required, after the unit positioning)
- 5. Electrical panel
- 6. Power input
- 7. Sound proof enclosure (only in the relevant versions)
- 8. Clearance access recommended

Size		ST-EXC		SC-EXC	
		200.2	210.2	200.2	210.2
H	mm	2484	2484	2484	2484
I	mm	2735	2735	2735	2735
J	mm	1127	1127	1127	1127
K	mm	834	834	834	834
L	mm	437	437	437	437
OD	mm	8"	8"	8"	8"
A - Length	mm	4788	4788	4788	4788
B - Depth	mm	2246	2246	2246	2246
C - Height	mm	2668	2668	2668	2668
W1 Supporting point	kg	1262	1267	1357	1362
W2 Supporting point	kg	1079	1076	1122	1118
W3 Supporting point	kg	1280	1282	1377	1379
W4 Supporting point	kg	1097	1091	1142	1136
Shipping weight	kg	4484	4484	4764	4762
Operating weight	kg	4717	4715	4997	4995

The presence of optional accessories may result in a substantial variation of the weights shown in the table. Fan diffusers are separately supplied.

## EXCELLENCE version

Size 220.2-260.2 - Acoustic configuration: standard (ST) / Compressor soundproofing (SC)

Size 200.2-220.2 - Acoustic configuration: super-silenced (EN)

DAA8E220 2\_260 2\_EXC\_ST\_SC\_EN\_0

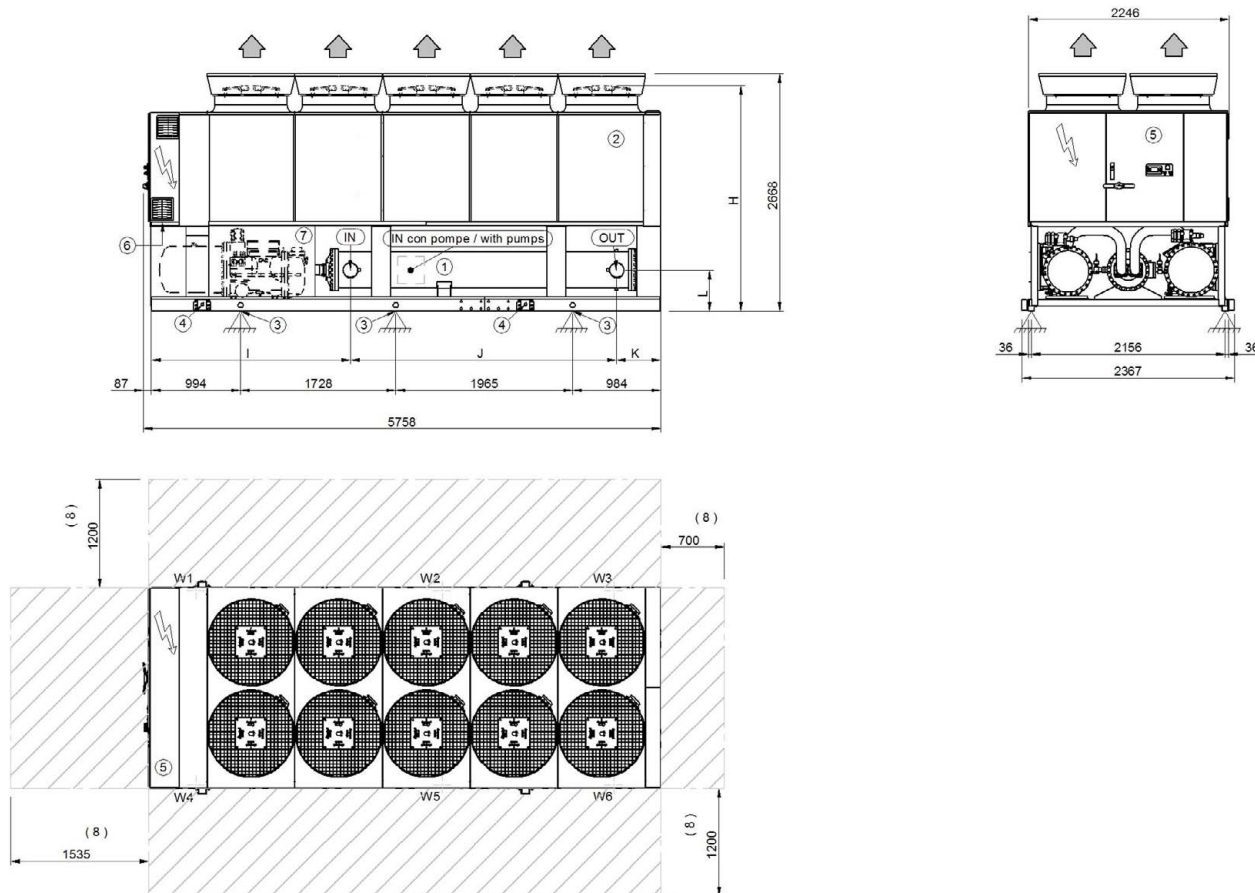

- |  |   |
|--|---|
| 1. Internal exchanger (evaporator)                                       | 5. Electrical panel                                       |
| 2. External exchanger (condenser)  | 6. Power input  |
| 3. Unit fixing holes   | 7. Sound proof enclosure ( only in the relevant versions) |
| 4. Lifting brackets (removable, if required, after the unit positioning) | 8. Clearance access recommended                           |

Grandezze		ST-EXC			SC-EXC			EN-EXC		
		220.2	240.2	260.2	220.2	240.2	260.2	200.2	210.2	220.2
H	mm	2484	2484	2484	2484	2484	2484	2510	2510	2510
I	mm	2925	2925	2925	2925	2925	2925	2925	2925	2925
J	mm	2962	2962	2962	2962	2962	2962	2412	2412	2962
K	mm	759	759	759	759	759	759	1309	1309	759
L	mm	457	457	457	457	457	457	457	457	457
OD	mm	6"	6"	6"	6"	6"	6"	6"	6"	6"
A - Length	mm	5758	5758	5758	5758	5758	5758	5758	5758	5758
B - Depth	mm	2246	2246	2246	2246	2246	2246	2246	2246	2246
C - Height	mm	2668	2668	2668	2668	2668	2668	2668	2668	2668
W1 Supporting point	kg	1098	1115	1148	1242	1259	1292	1244	1272	1309
W2 Supporting point	kg	1075	1081	1084	1076	1082	1085	991	1012	1039
W3 Supporting point	kg	588	593	598	589	594	599	606	621	640
W4 Supporting point	kg	1049	1065	1109	1185	1201	1245	1186	1222	1250
W5 Supporting point	kg	1028	1033	1048	1027	1032	1046	945	972	992
W6 Supporting point	kg	562	567	578	562	566	577	578	596	611
Shipping weight	kg	5094	5147	5258	5374	5427	5538	5244	5389	5534
Operating weight	kg	5401	5454	5565	5681	5734	5845	5551	5696	5841

The presence of optional accessories may result in a substantial variation of the weights shown in the table. Fan diffusers are separately supplied.

# EXCELLENCE version

Size 280.2-320.2 - Acoustic configuration: standard (ST) / Compressor soundproofing (SC)

Size 240.2-260.2 - Acoustic configuration: super-silenced (EN)

DAA8E280 2\_320 2\_EXC\_ST\_SC\_EN\_0

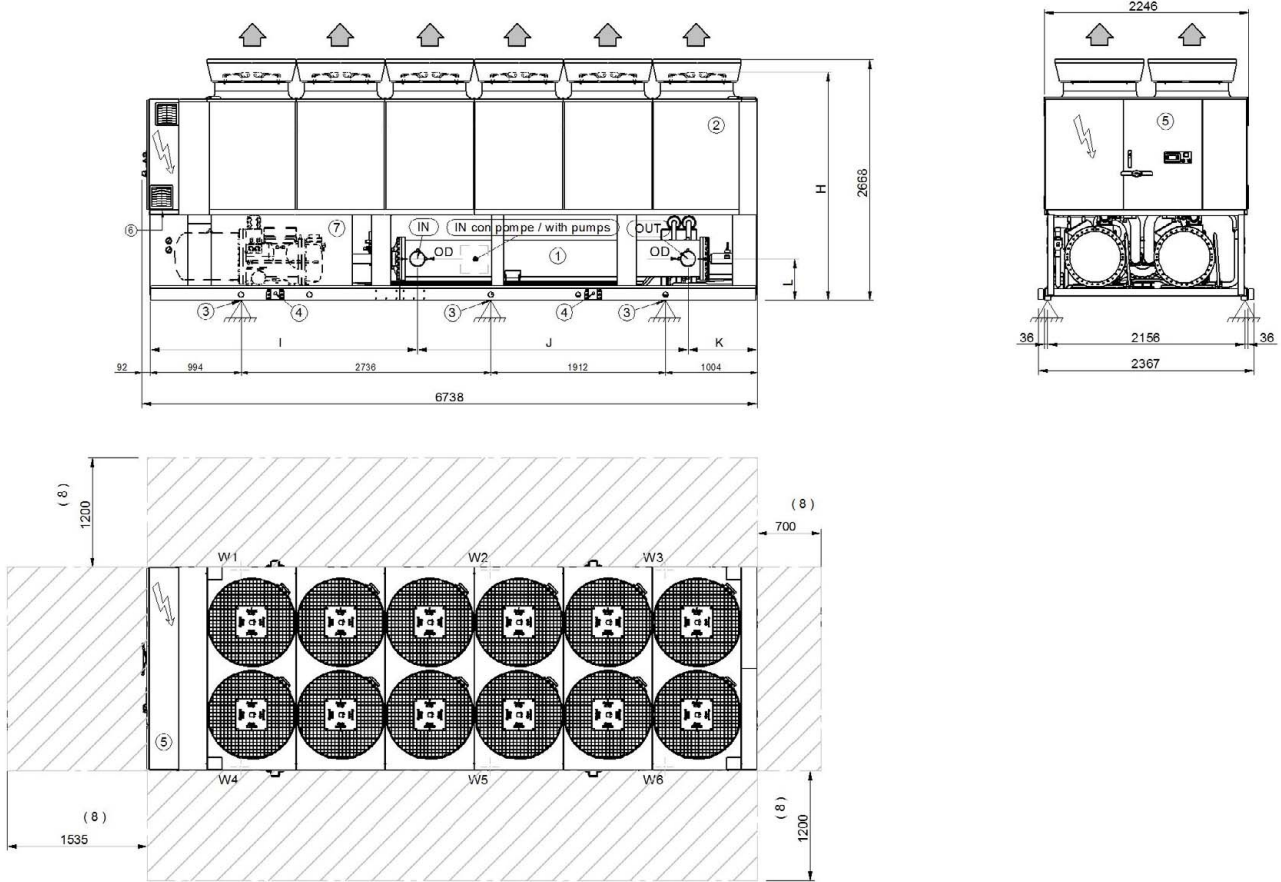

- 1. Internal exchanger (evaporator)
- 2. External exchanger (condenser)
- 3. Unit fixing holes
- 4. Lifting brackets (removable, if required, after the unit positioning)
- 5. Electrical panel
- 6. Power input
- 7. Sound proof enclosure (only in the relevant versions)
- 8. Clearance access recommended

Size		ST-EXC		SC-EXC		EN-EXC	
		280.2	320.2	280.2	320.2	240.2	260.2
H	mm	2484	2484	2484	2484	2510	2510
I	mm	2925	2925	2925	2925	2925	2925
J	mm	2962	2962	2962	2962	2962	2962
K	mm	759	759	759	759	759	759
L	mm	457	457	457	457	457	457
OD	mm	6"	6"	6"	6"	6"	6"
A - Length	mm	6738	6738	6738	6738	6738	6738
B - Depth	mm	2246	2246	2246	2246	2246	2246
C - Height	mm	2668	2668	2668	2668	2668	2668
W1 Supporting point	kg	1424	1483	1544	1602	1451	1508
W2 Supporting point	kg	1158	1188	1192	1222	1134	1176
W3 Supporting point	kg	527	537	520	530	499	521
W4 Supporting point	kg	1365	1421	1476	1532	1388	1458
W5 Supporting point	kg	1109	1138	1140	1169	1084	1137
W6 Supporting point	kg	505	515	497	507	477	504
Shipping weight	kg	5808	6002	6088	6282	5726	5996
Operating weight	kg	6088	6282	6368	6562	6033	6303

The presence of optional accessories may result in a substantial variation of the weights shown in the table. Fan diffusers are separately supplied.

## EXCELLENCE version

Size 340.2-360.2 - Acoustic configuration: standard (ST) / Compressor soundproofing (SC)

Size 280.2 - Acoustic configuration: super-silenced (EN)

DAA8E340 2\_360 2\_EXC\_ST\_SC\_EN 0

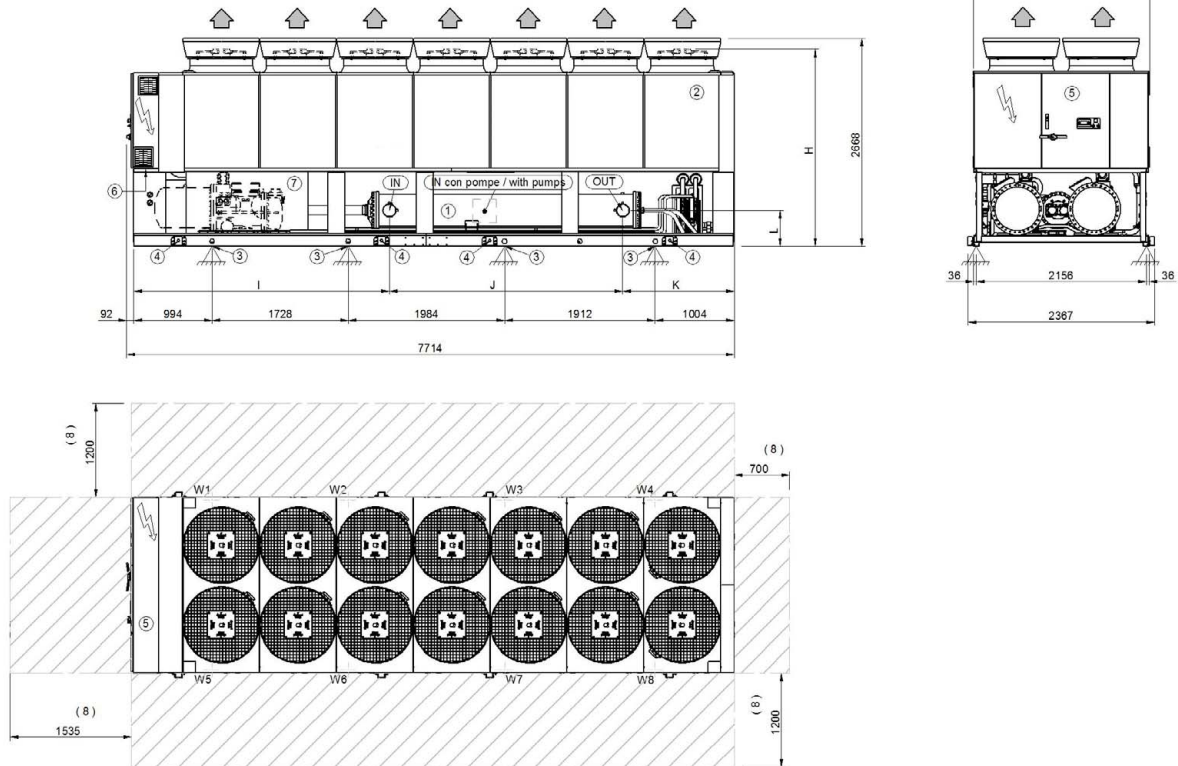

- |  |   |
|--|---|
| 1. Internal exchanger (evaporator)                                       | 5. Electrical panel                                       |
| 2. External exchanger (condenser)  | 6. Power input  |
| 3. Unit fixing holes   | 7. Sound proof enclosure ( only in the relevant versions) |
| 4. Lifting brackets (removable, if required, after the unit positioning) | 8. Clearance access recommended                           |

Size		ST-EXC		SC-EXC		EN-EXC
		340.2	360.2	340.2	360.2	280.2
H	mm	2484	2484	2484	2484	2510
I	mm	3245	3245	3245	3245	2980
J	mm	2962	2962	2962	2962	2910
K	mm	1415	1415	1415	1415	1732
L	mm	457	457	457	457	457
OD	mm	6"	6"	6"	6"	6"
A - Length	mm	7714	7714	7714	7714	7714
B - Depth	mm	2246	2246	2246	2246	2246
C - Height	mm	2668	2668	2668	2668	2668
W1 Supporting point	kg	1434	1578	1550	1694	1339
W2 Supporting point	kg	760	825	794	858	923
W3 Supporting point	kg	802	819	802	819	713
W4 Supporting point	kg	586	607	586	607	580
W5 Supporting point	kg	1406	1475	1509	1578	1281
W6 Supporting point	kg	746	771	773	799	883
W7 Supporting point	kg	764	781	764	781	682
W8 Supporting point	kg	558	579	558	579	555
Shipping weight	kg	6775	7155	7055	7435	6676
Operating weight	kg	7055	7435	7335	7715	6956

The presence of optional accessories may result in a substantial variation of the weights shown in the table. Fan diffusers are separately supplied.

# EXCELLENCE version

Size 400.2-440.2 - Acoustic configuration: standard (ST) / compressor soundproofing (SC)

Size 320.2-360.2 - Acoustic configuration: super-silenced (EN)

DAA8E400 2\_440 2\_EXC\_ST\_SC\_EN\_0

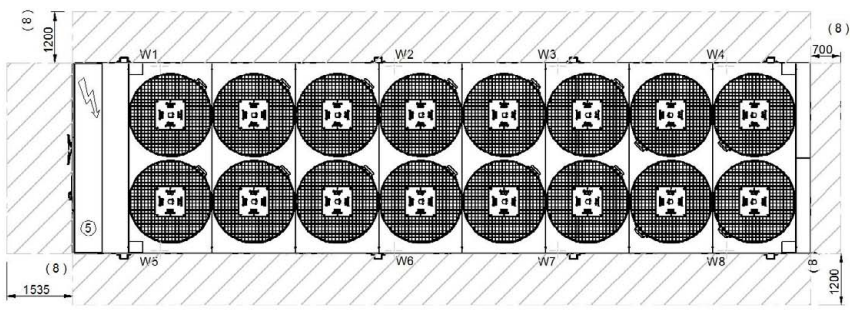
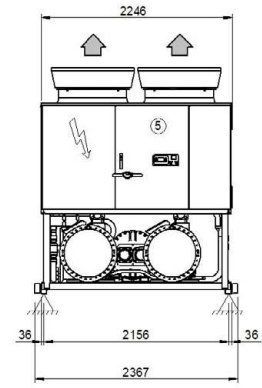
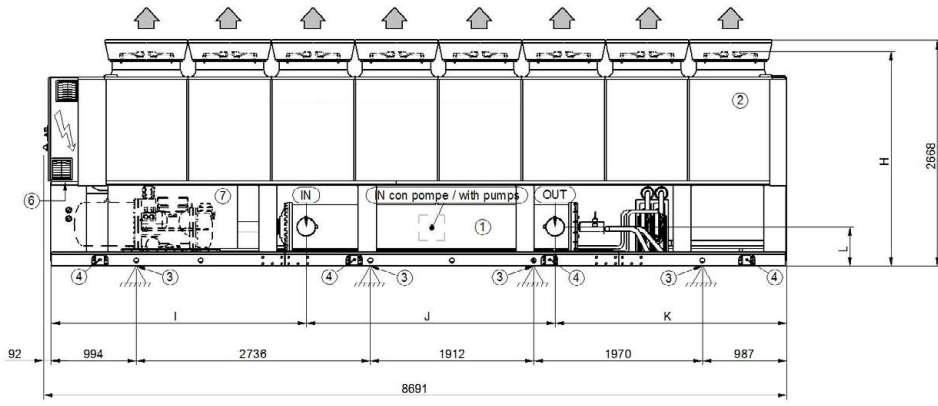

- 1. Internal exchanger (evaporator)
- 2. External exchanger (condenser)
- 3. Unit fixing holes
- 4. Lifting brackets (removable, if required, after the unit positioning)
- 5. Electrical panel
- 6. Power input
- 7. Sound proof enclosure ( only in the relevant versions)
- 8. Clearance access recommended

Size		ST-EXC		SC-EXC		EN-EXC		
		400.2	440.2	400.2	440.2	320.2	340.2	360.2
H	mm	2484	2484	2484	2484	2510	2510	2510
I	mm	2980	2980	2980	2980	3245	3245	3245
J	mm	2910	2910	2910	2910	2962	2962	2962
K	mm	2709	2709	2709	2709	2392	2392	2392
L	mm	457	457	457	457	457	457	457
OD	mm	8"	8"	8"	8"	6"	6"	6"
A - Length	mm	8691	8691	8691	8691	8691	8691	8691
B - Depth	mm	2246	2246	2246	2246	2246	2246	2246
C - Height	mm	2668	2668	2668	2668	2668	2668	2668
W1 Supporting point	kg	1496	1520	1603	1627	1466	1529	1641
W2 Supporting point	kg	1069	1088	1108	1127	961	980	1042
W3 Supporting point	kg	978	1003	978	1003	844	851	858
W4 Supporting point	kg	555	563	555	563	563	571	579
W5 Supporting point	kg	1429	1453	1528	1552	1404	1518	1568
W6 Supporting point	kg	1021	1040	1056	1075	921	972	995
W7 Supporting point	kg	935	959	935	959	809	817	824
W8 Supporting point	kg	530	538	530	538	540	548	557
Shipping weight	kg	7532	7684	7812	7964	7228	7506	7784
Operating weight	kg	8013	8165	8293	8445	7508	7786	8064

The presence of optional accessories may result in a substantial variation of the weights shown in the table. Fan diffusers are separately supplied.

# EXCELLENCE version

Size 500.2-580.2 - Acoustic configuration: standard (ST) / compressor soundproofing (SC)

Size 400.2-500.2 - Acoustic configuration: super-silenced (EN)

DAA8E500 2\_580 2\_EXC\_ST\_SC\_EN\_0

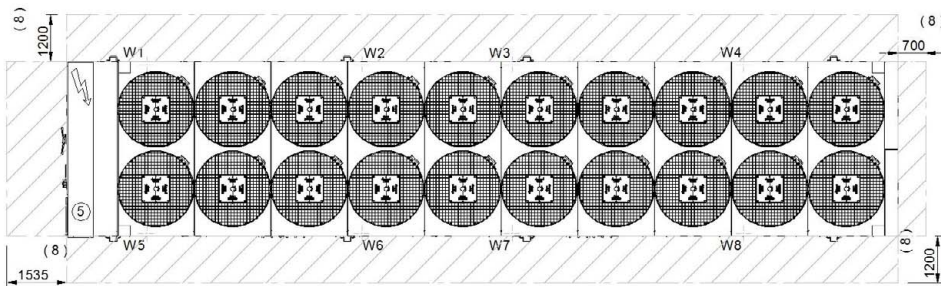
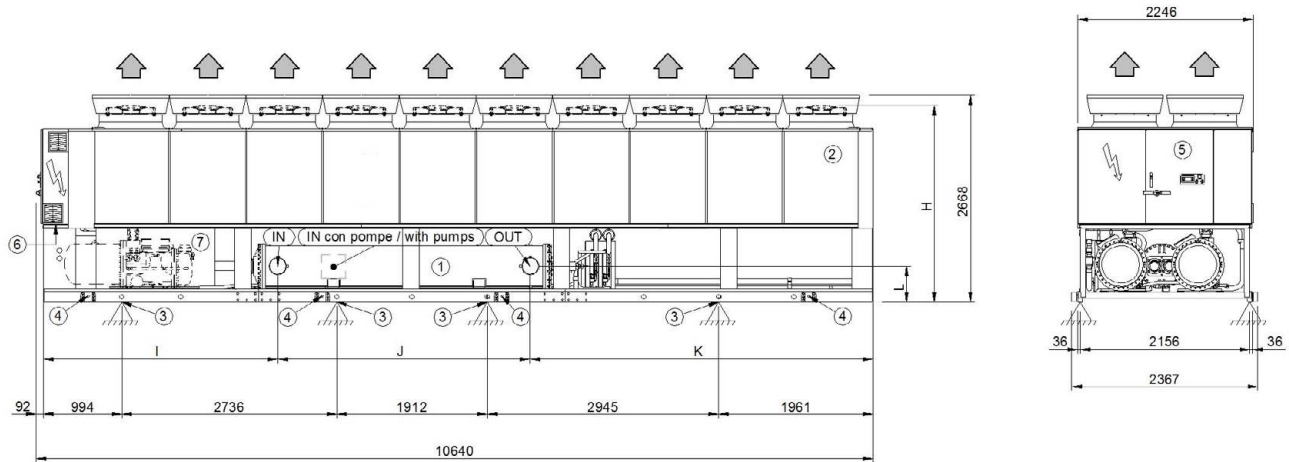

- 1. Internal exchanger (evaporator)
- 2. External exchanger (condenser)
- 3. Unit fixing holes
- 4. Lifting brackets (removable, if required, after the unit positioning)
- 5. Electrical panel
- 6. Power input
- 7. Sound proof enclosure (only in the relevant versions)
- 8. Clearance access recommended

Size		ST-EXC			SC-EXC			EN-EXC		
		500.2	540.2	580.2	500.2	540.2	580.2	400.2	440.2	500.2
H	mm	2484	2484	2484	2484	2484	2484	2510	2510	2510
I	mm	2980	2980	2980	2980	2980	2980	2980	2980	2980
J	mm	3210	3210	3210	3210	3210	3210	2910	2910	3210
K	mm	4359	4359	4359	4359	4359	4359	4659	4659	4359
L	mm	457	457	457	457	457	457	457	457	457
OD	mm	8"	8"	8"	8"	8"	8"	8"	8"	8"
A - Length	mm	10640	10640	10640	10640	10640	10640	10640	10640	10640
B - Depth	mm	2246	2246	2246	2246	2246	2246	2246	2246	2246
C - Height	mm	2668	2668	2668	2668	2668	2668	2668	2668	2668
W1 Supporting point	kg	1749	1838	1886	1876	1966	2014	1832	1873	1929
W2 Supporting point	kg	1081	1123	1148	1099	1141	1166	1065	1097	1148
W3 Supporting point	kg	926	962	986	926	962	986	907	938	976
W4 Supporting point	kg	601	637	657	601	637	657	595	626	652
W5 Supporting point	kg	1668	1754	1801	1787	1873	1920	1746	1787	1840
W6 Supporting point	kg	1031	1072	1096	1047	1088	1111	1015	1046	1095
W7 Supporting point	kg	892	928	953	892	928	953	872	904	943
W8 Supporting point	kg	579	615	634	579	615	634	572	604	630
Shipping weight	kg	8014	9047	8647	8294	9327	8927	8124	8396	8698
Operating weight	kg	8527	9560	9160	8807	9840	9440	8604	8879	9211

The presence of optional accessories may result in a substantial variation of the weights shown in the table. Fan diffusers are separately supplied.

# Dimensional drawings - PREMIUM version

Size 200.2-260.2 - Acoustic configuration: standard (ST) / Compressor soundproofing (SC)

Size 200.2-240.2 - Acoustic configuration: super-silenced (EN)

DAA8E200 2\_260 2\_PRM\_ST\_SC\_EN\_0

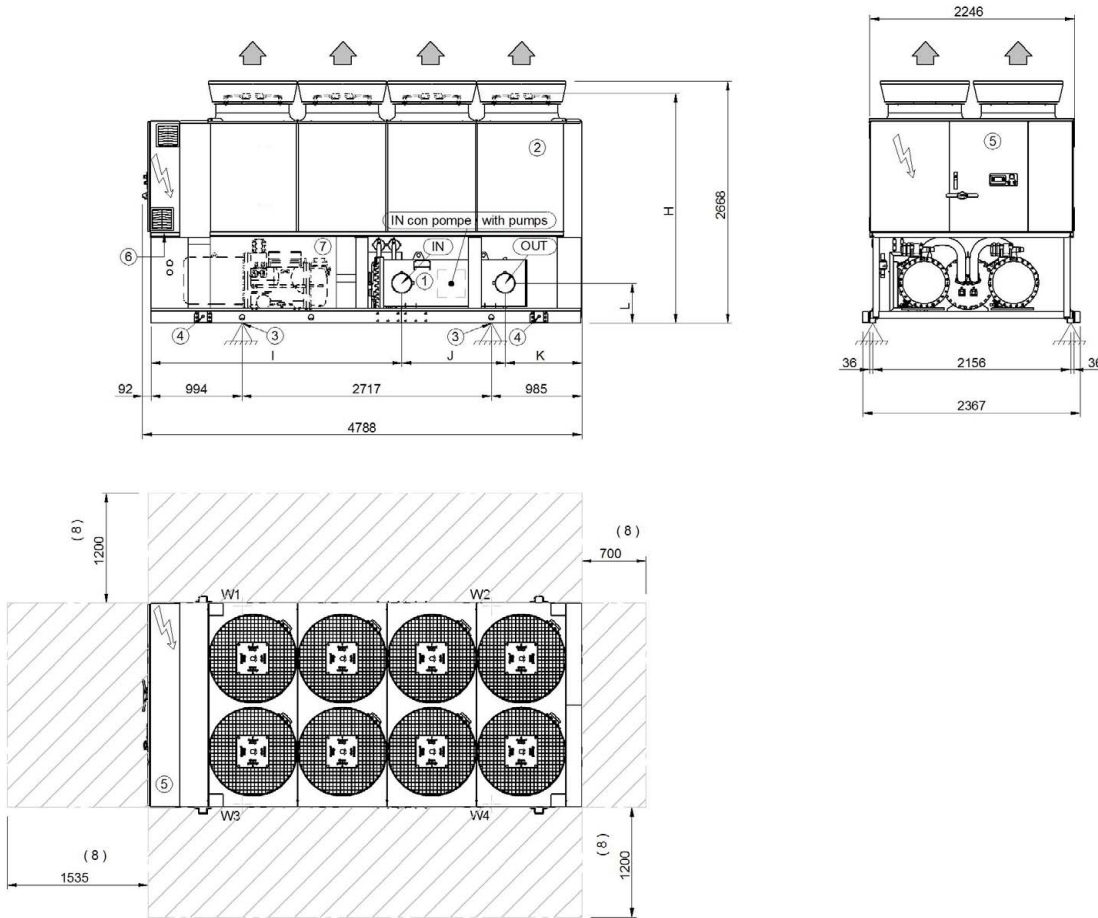

- 1. Internal exchanger (evaporator)
- 2. External exchanger (condenser)
- 3. Unit fixing holes
- 4. Lifting brackets (removable, if required, after the unit positioning)
- 5. Electrical panel
- 6. Power input
- 7. Sound proof enclosure (only in the relevant versions)
- 8. Clearance access recommended

Size		ST-PRM					SC-PRM					EN-PRM			
		200.2	210.2	220.2	240.2	260.2	200.2	210.2	220.2	240.2	260.2	200.2	210.2	220.2	240.2
H	mm	2484	2484	2484	2484	2484	2484	2484	2484	2484	2484	2510	2510	2510	2510
I	mm	2735	2735	2735	2735	2735	2735	2735	2735	2735	2735	2735	2735	2735	2735
J	mm	1127	1127	1127	1127	1127	1127	1127	1127	1127	1127	1127	1127	1127	1127
K	mm	834	834	834	834	834	834	834	834	834	834	834	834	834	834
L	mm	437	437	437	437	437	437	437	437	437	437	437	437	437	437
OD	mm	8"	8"	8"	8"	8"	8"	8"	8"	8"	8"	8"	8"	8"	8"
A - Length	mm	4788	4788	4788	4788	4788	4788	4788	4788	4788	4788	4788	4788	4788	4788
B - Depth	mm	2246	2246	2246	2246	2246	2246	2246	2246	2246	2246	2246	2246	2246	2246
C - Height	mm	2668	2668	2668	2668	2668	2668	2668	2668	2668	2668	2668	2668	2668	2668
W1 Supporting point	kg	1243	1253	1261	1290	1324	1338	1348	1355	1384	1419	1338	1358	1386	1396
W2 Supporting point	kg	1048	1054	1056	1092	1116	1091	1096	1099	1134	1159	1091	1112	1148	1153
W3 Supporting point	kg	1261	1268	1279	1308	1335	1358	1366	1376	1406	1433	1358	1375	1407	1417
W4 Supporting point	kg	1066	1068	1074	1110	1127	1111	1114	1119	1155	1173	1111	1130	1169	1174
Shipping weight	kg	4384	4410	4436	4566	4670	4664	4690	4716	4846	4950	4664	4742	4876	4906
Operating weight	kg	4617	4643	4669	4799	4903	4897	4923	4949	5079	5183	4897	4975	5109	5139

The presence of optional accessories may result in a substantial variation of the weights shown in the table. Fan diffusers are separately supplied.

# PREMIUM version

Size 280.2-320.2 - Acoustic configuration: standard (ST) / Compressor soundproofing (SC)

Size 260.2-280.2 - Acoustic configuration: super-silenced (EN)

DAA8E280 2\_320 2\_PRM\_ST\_SC\_EN\_0

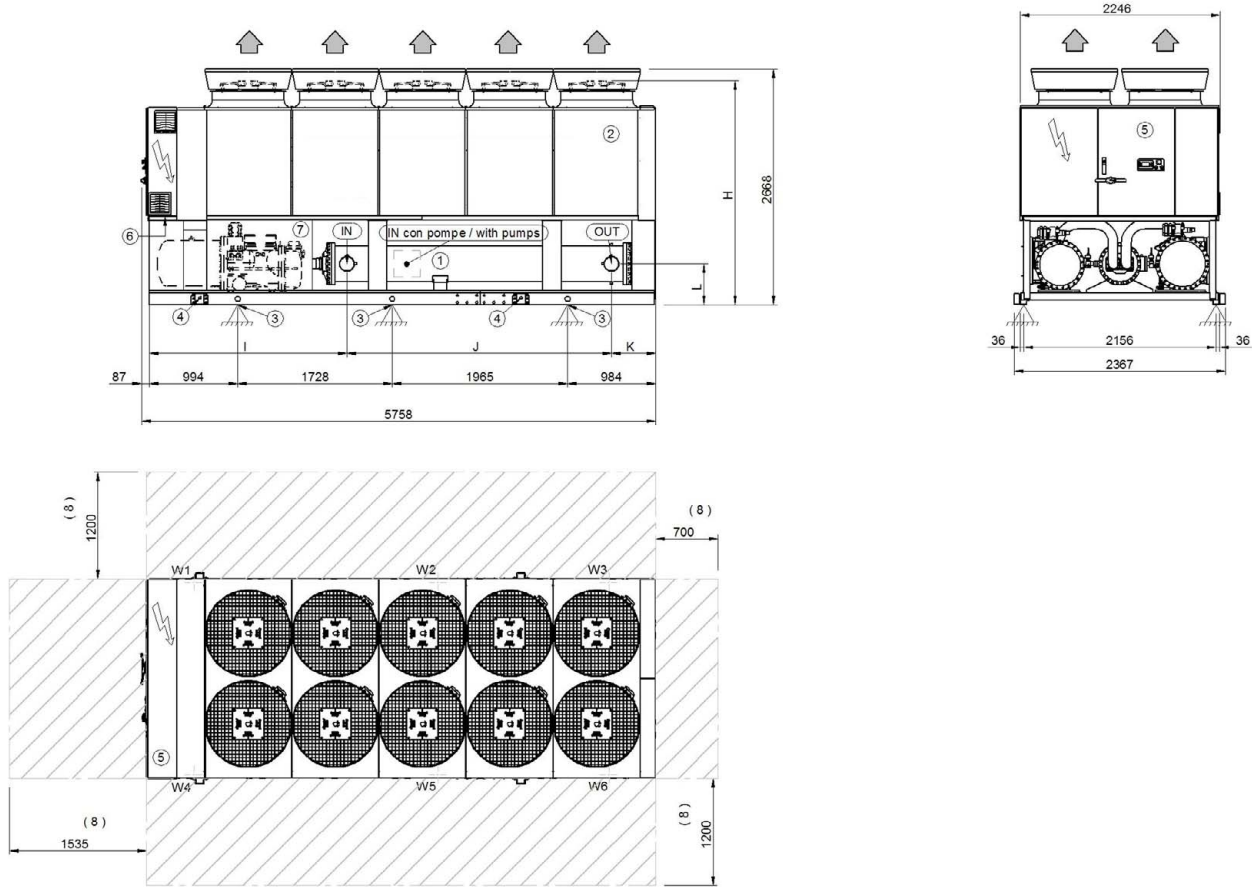

- 1. Internal exchanger (evaporator)
- 2. External exchanger (condenser)
- 3. Unit fixing holes
- 4. Lifting brackets (removable, if required, after the unit positioning)
- 5. Electrical panel
- 6. Power input
- 7. Sound proof enclosure (only in the relevant versions)
- 8. Clearance access recommended

Size		ST-PRM		SC-PRM		EN-PRM	
		280.2	320.2	280.2	320.2	260.2	280.2
H	mm	2484	2484	2484	2484	2510	2510
I	mm	2925	2925	2925	2925	2925	2925
J	mm	2962	2962	2962	2962	2412	2962
K	mm	759	759	759	759	1309	759
L	mm	457	457	457	457	457	457
OD	mm	6"	6"	6"	6"	6"	6"
A - Length	mm	5758	5758	5758	5758	5758	5758
B - Depth	mm	2246	2246	2246	2246	2246	2246
C - Height	mm	2668	2668	2668	2668	2668	2668
W1 Supporting point	kg	1242	1280	1349	1387	1339	1402
W2 Supporting point	kg	1002	1018	1046	1062	1044	1078
W3 Supporting point	kg	627	625	622	620	627	635
W4 Supporting point	kg	1186	1221	1285	1321	1300	1336
W5 Supporting point	kg	957	971	997	1012	1014	1027
W6 Supporting point	kg	599	597	592	590	609	605
Shipping weight	kg	5305	5405	5585	5685	5626	5776
Operating weight	kg	5612	5712	5892	5992	5933	6083

The presence of optional accessories may result in a substantial variation of the weights shown in the table. Fan diffusers are separately supplied.



# PREMIUM version

Size 340.2-400.2 - Acoustic configuration: standard (ST) / Compressor soundproofing (SC)

Size 320.2-340.2 - Acoustic configuration: super-silenced (EN)

DAA8E340 2\_400 2\_PRM\_ST\_SC\_EN\_0

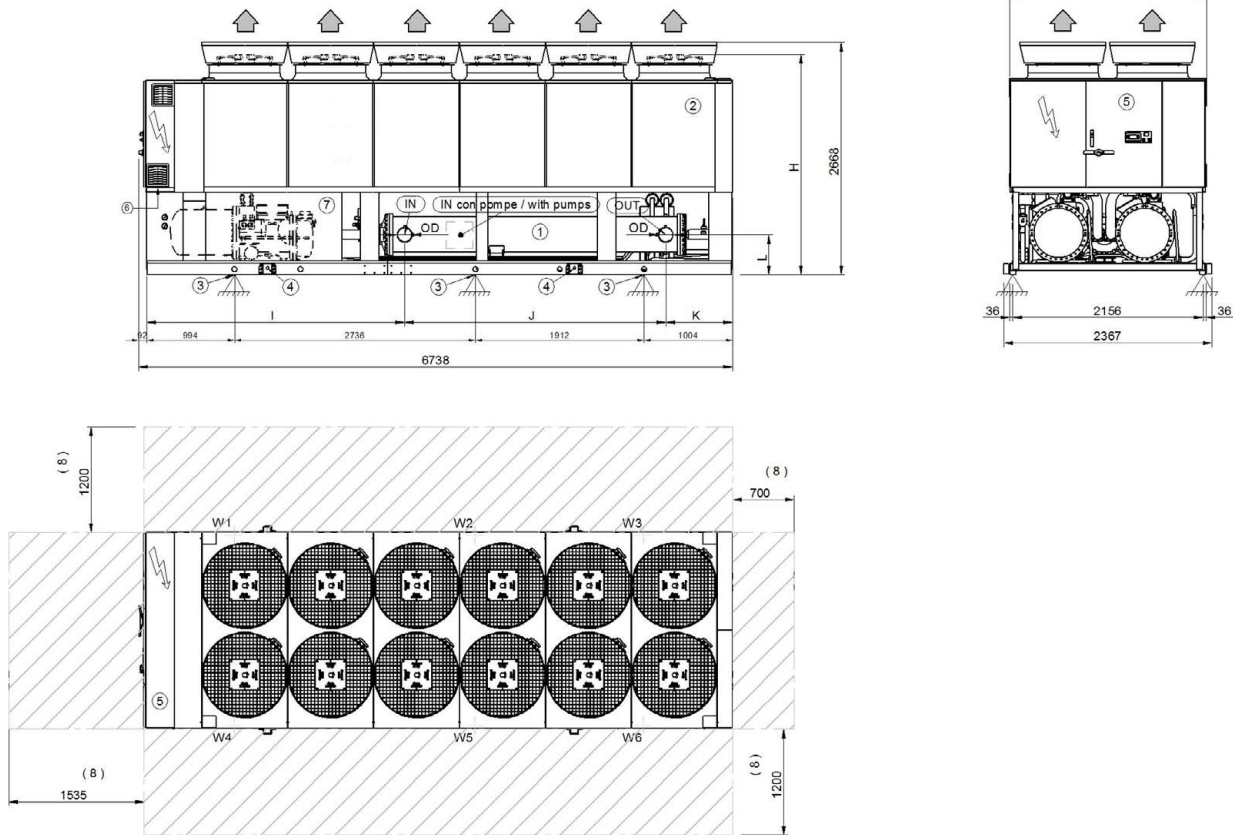

- 1. Internal exchanger (evaporator)
- 2. External exchanger (condenser)
- 3. Unit fixing holes
- 4. Lifting brackets (removable, if required, after the unit positioning)
- 5. Electrical panel
- 6. Power input
- 7. Sound proof enclosure (only in the relevant versions)
- 8. Clearance access recommended

Size		ST-PRM			SC-PRM			EN-PRM	
		340.2	360.2	400.2	340.2	360.2	400.2	320.2	340.2
H	mm	2484	2484	2484	2484	2484	2484	2510	2510
I	mm	2925	2925	2925	2925	2925	2925	2925	2925
J	mm	2962	2962	2962	2962	2962	2962	2962	2962
K	mm	759	759	759	759	759	759	759	759
L	mm	457	457	457	457	457	457	457	457
OD	mm	6"	6"	6"	6"	6"	6"	6"	6"
A - Length	mm	6738	6738	6738	6738	6738	6738	6738	6738
B - Depth	mm	2246	2246	2246	2246	2246	2246	2246	2246
C - Height	mm	2668	2668	2668	2668	2668	2668	2668	2668
W1 Supporting point	kg	1678	1673	1715	1681	1793	1835	1581	1666
W2 Supporting point	kg	1151	1235	1272	1143	1269	1306	1193	1221
W3 Supporting point	kg	468	498	521	460	490	513	513	512
W4 Supporting point	kg	1600	1594	1636	1650	1706	1748	1511	1636
W5 Supporting point	kg	1098	1177	1213	1121	1207	1244	1141	1199
W6 Supporting point	kg	446	474	497	451	466	489	490	503
Shipping weight	kg	6135	6170	6373	6199	6450	6653	6122	6430
Operating weight	kg	6442	6651	6854	6506	6931	7134	6429	6737

The presence of optional accessories may result in a substantial variation of the weights shown in the table. Fan diffusers are separately supplied.

## PREMIUM version

Size 440.2-500.2 - Acoustic configuration: standard (ST) / Compressor soundproofing (SC)

Size 360.2-400.2 - Acoustic configuration: super-silenced (EN)

DAA8E440 2\_500 2\_PRM\_ST\_SC\_EN\_0

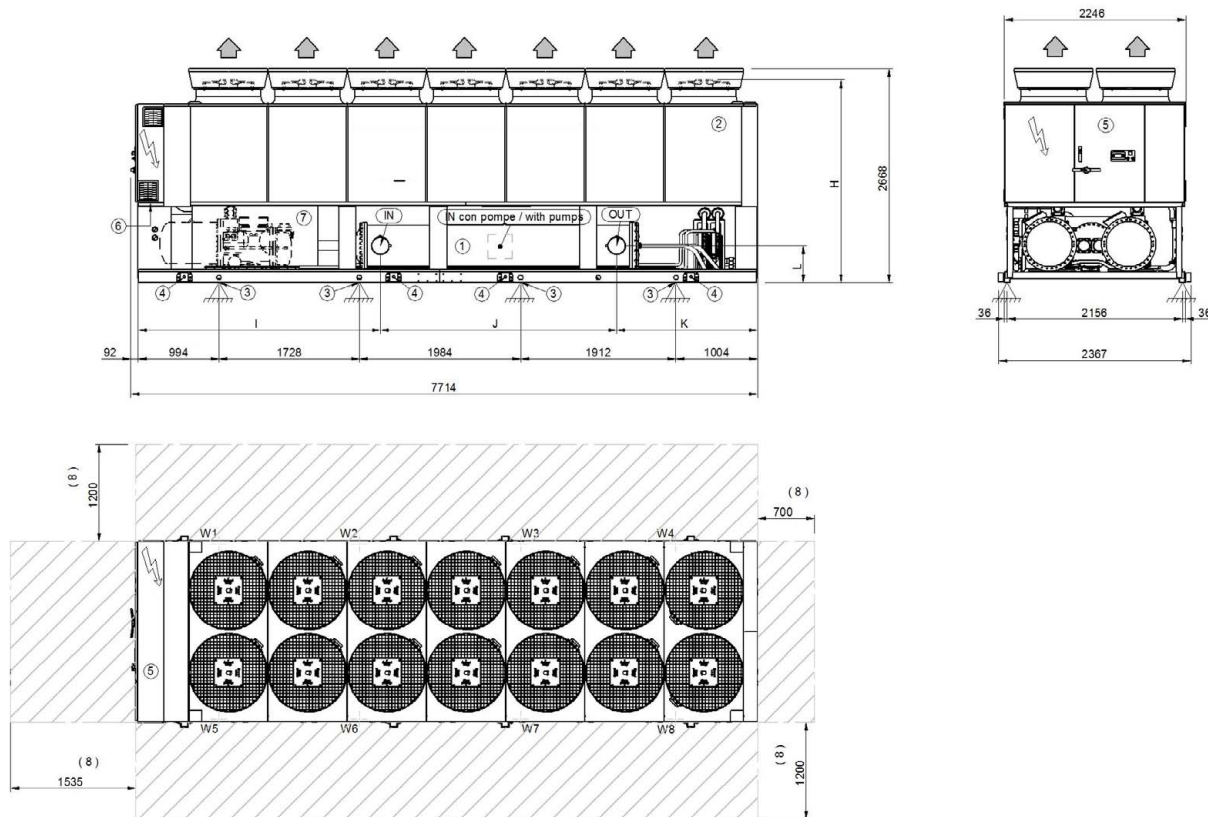

- 1. Internal exchanger (evaporator)
- 2. External exchanger (condenser)
- 3. Unit fixing holes
- 4. Lifting brackets (removable, if required, after the unit positioning)
- 5. Electrical panel
- 6. Power input
- 7. Sound proof enclosure (only in the relevant versions)
- 8. Clearance access recommended

Size		ST-PRM		SC-PRM		EN-PRM	
		440.2	500.2	440.2	500.2	360.2	400.2
H	mm	2484	2484	2484	2484	2510	2510
I	mm	2980	2980	2980	2980	2980	2980
J	mm	2910	2910	2910	2910	3210	3210
K	mm	1732	1732	1732	1732	1432	1432
L	mm	457	457	457	457	457	457
OD	mm	8"	8"	8"	8"	8"	8"
A - Length	mm	7714	7714	7714	7714	7714	7714
B - Depth	mm	2246	2246	2246	2246	2246	2246
C - Height	mm	2668	2668	2668	2668	2668	2668
W1 Supporting point	kg	1464	1514	1573	1624	1535	1500
W2 Supporting point	kg	952	978	989	1015	1004	1358
W3 Supporting point	kg	909	924	909	924	757	784
W4 Supporting point	kg	618	633	618	633	537	655
W5 Supporting point	kg	1398	1446	1499	1547	1462	1378
W6 Supporting point	kg	909	934	942	967	957	1248
W7 Supporting point	kg	864	879	864	879	723	725
W8 Supporting point	kg	587	602	587	602	513	606
Shipping weight	kg	7221	7431	7501	7711	7208	7774
Operating weight	kg	7701	7911	7981	8191	7488	8254

The presence of optional accessories may result in a substantial variation of the weights shown in the table. Fan diffusers are separately supplied.

# PREMIUM version

Size 540.2-580.2 - Acoustic configuration: standard (ST) / compressor soundproofing (SC)

Size 440.2 - Acoustic configuration: super-silenced (EN)

DAA8E540 2\_580 2\_PRM\_ST\_SC\_EN\_0

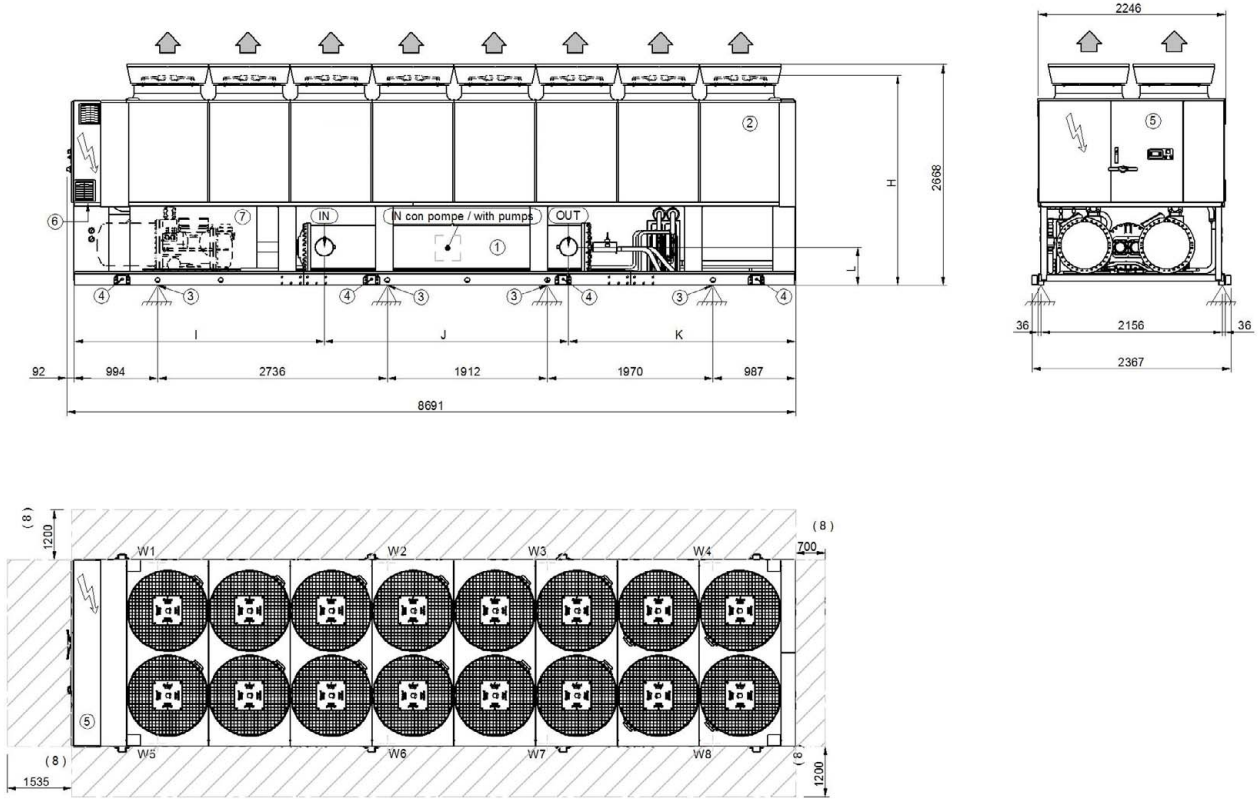

- 1. Internal exchanger (evaporator)
- 2. External exchanger (condenser)
- 3. Unit fixing holes
- 4. Lifting brackets (removable, if required, after the unit positioning)
- 5. Electrical panel
- 6. Power input
- 7. Sound proof enclosure (only in the relevant versions)
- 8. Clearance access recommended

Size		ST-PRM		SC-PRM		EN-PRM
		540.2	580.2	540.2	580.2	440.2
H	mm	2484	2484	2484	2484	2510
I	mm	2980	2980	2980	2980	2980
J	mm	3210	3210	3210	3210	2910
K	mm	2409	2409	2409	2409	2709
L	mm	457	457	457	457	457
OD	mm	8"	8"	8"	8"	8"
A - Length	mm	8691	8691	8691	8691	8691
B - Depth	mm	2246	2246	2246	2246	2246
C - Height	mm	2668	2668	2668	2668	2668
W1 Supporting point	kg	1537	1573	1643	1679	1591
W2 Supporting point	kg	1255	1278	1295	1318	1228
W3 Supporting point	kg	892	910	892	910	838
W4 Supporting point	kg	561	572	561	572	576
W5 Supporting point	kg	1462	1496	1560	1594	1515
W6 Supporting point	kg	1194	1216	1230	1252	1169
W7 Supporting point	kg	855	873	855	873	804
W8 Supporting point	kg	537	549	537	549	553
Shipping weight	kg	7596	7770	7876	8050	7794
Operating weight	kg	8293	8467	8573	8747	8274

The presence of optional accessories may result in a substantial variation of the weights shown in the table. Fan diffusers are separately supplied.

# PREMIUM version

## Size 500.2-580.2 - Acoustic configuration: super-silenced (EN)

DAA8E500 2\_580 2\_PRM\_EN\_0

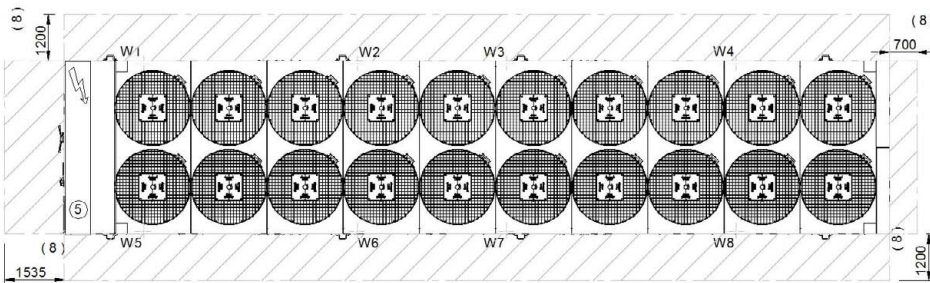
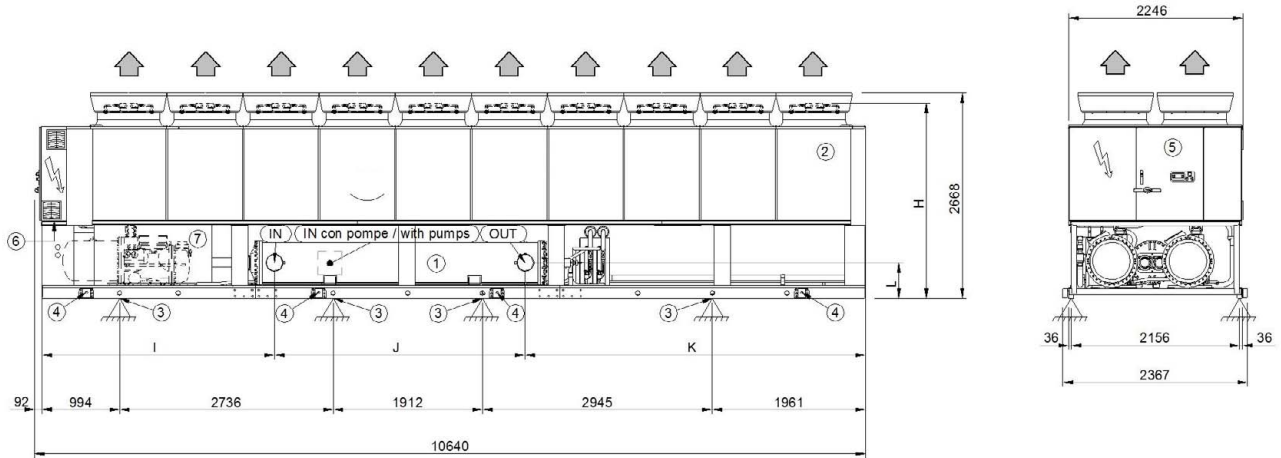

- 1. Internal exchanger (evaporator)
- 2. External exchanger (condenser)
- 3. Unit fixing holes
- 4. Lifting brackets (removable, if required, after the unit positioning)
- 5. Electrical panel
- 6. Power input
- 7. Sound proof enclosure (only in the relevant versions)
- 8. Clearance access recommended

Size		EN-PRM		
		500.2	540.2	580.2
H	mm	2510	2510	2510
I	mm	2980	2980	2980
J	mm	2910	3210	3210
K	mm	4659	4359	4359
L	mm	457	457	457
OD	mm	8"	8"	8"
A - Length	mm	10640	10640	10640
B - Depth	mm	2246	2246	2246
C - Height	mm	2668	2668	2668
W1 Supporting point	kg	1888	1966	2014
W2 Supporting point	kg	1077	1141	1166
W3 Supporting point	kg	905	962	986
W4 Supporting point	kg	604	637	657
W5 Supporting point	kg	1799	1873	1920
W6 Supporting point	kg	1026	1088	1111
W7 Supporting point	kg	873	928	953
W8 Supporting point	kg	583	615	634
Shipping weight	kg	8274	8697	8927
Operating weight	kg	8754	9210	9440

The presence of optional accessories may result in a substantial variation of the weights shown in the table. Fan diffusers are separately supplied.

Page intentionally left blank

**CLIVET SPA**

Via Camp Lonc 25, Z.I. Villapaiera - 32032 Feltre (BL) - Italy  
Tel. + 39 0439 3131 - Fax + 39 0439 313300 - info@clivet.it

**Clivet Group UK Limited**

4 Kingdom Close, Segensworth East - Fareham, Hampshire - PO15 5TJ - United Kingdom  
Tel. + 44 (0) 1489 572238 - Fax + 44 (0) 1489 573033 - enquiries@clivetgroup.co.uk

**Clivet Group UK Limited (Operations)**

Units F5&F6 Railway Triangle Ind Est, Walton Road - Portsmouth, Hampshire - PO6 1TG - United Kingdom  
Tel. +44 (0) 2392 381235 - Fax. +44 (0) 2392 381243 - service@clivetgroup.co.uk

**CLIVET ESPAÑA S.A.U.**

C/ Bac de Roda, 36 - 08019 Barcelona - España  
Tel: +34 93 8606248 - Fax +34 93 8855392 - info@clivet.es

Av.Manoteras Nº 38, Oficina C303 - 28050 Madrid - España  
Tel. +34 91 6658280 - Fax +34 91 6657806 - info@clivet.es

**CLIVET GmbH**

Hummelsbütteler Steindamm 84, 22851 Norderstedt - Germany  
Tel. + 49 (0) 40 32 59 57-0 - Fax + 49 (0) 40 32 59 57-194 - info.de@clivet.com

**CLIVET RUSSIA**

Elektrozavodskaya st. 24, office 509 - 107023, Moscow, Russia  
Tel. + 74956462009 - Fax + 74956462009 - info.ru@clivet.com

**CLIVET MIDEAST FZCO**

Dubai Silicon Oasis (DSO), High Bay Complex, Office N. 20, PO BOX 342009, Dubai, UAE  
Tel. + 9714 3208499 - Fax + 9714 3208216 - info@clivet.ae

**CLIVET AIRCONDITIONING SYSTEMS PRIVATE LIMITED**

501/502, Commercial-1, Kohinoor City, Old Premier Compound, Kirol Road, Off L B S Marg, Kurla West - Mumbai  
400 070 - India info.in@clivet.com