

ROOMPack CAS-X

High efficiency cooling only packaged air-conditioner condenser,
ductable for indoor installation

CAS-X 31-222 RANGE

Cooling capacity from 10 to 76 kW

- ▶ Refrigerant circuit with R-410A Scroll compressors
- ▶ Electronic controlled EC fans
- ▶ Very high seasonal efficiency
- ▶ Ultra-compact



ROOMPack contains all components for the system simplification

Thanks to its packaged construction, ROOMPACK contains the main system components necessary for a correct operation. Thus, it reduces set up time and increases system reliability.

The air is taken from the served rooms, strained and treated by the direct expansion circuit, then returned to the air-conditioned area through the supply opening in an upward direction.

The built-in automatic control is based on the conditions as read by the ambient sensors which are supplied as standard, which activate available capacity in order to maintain the set comfort conditions. If installation of ambient sensors is not suitable, optional temperature and humidity probes are available built-in.

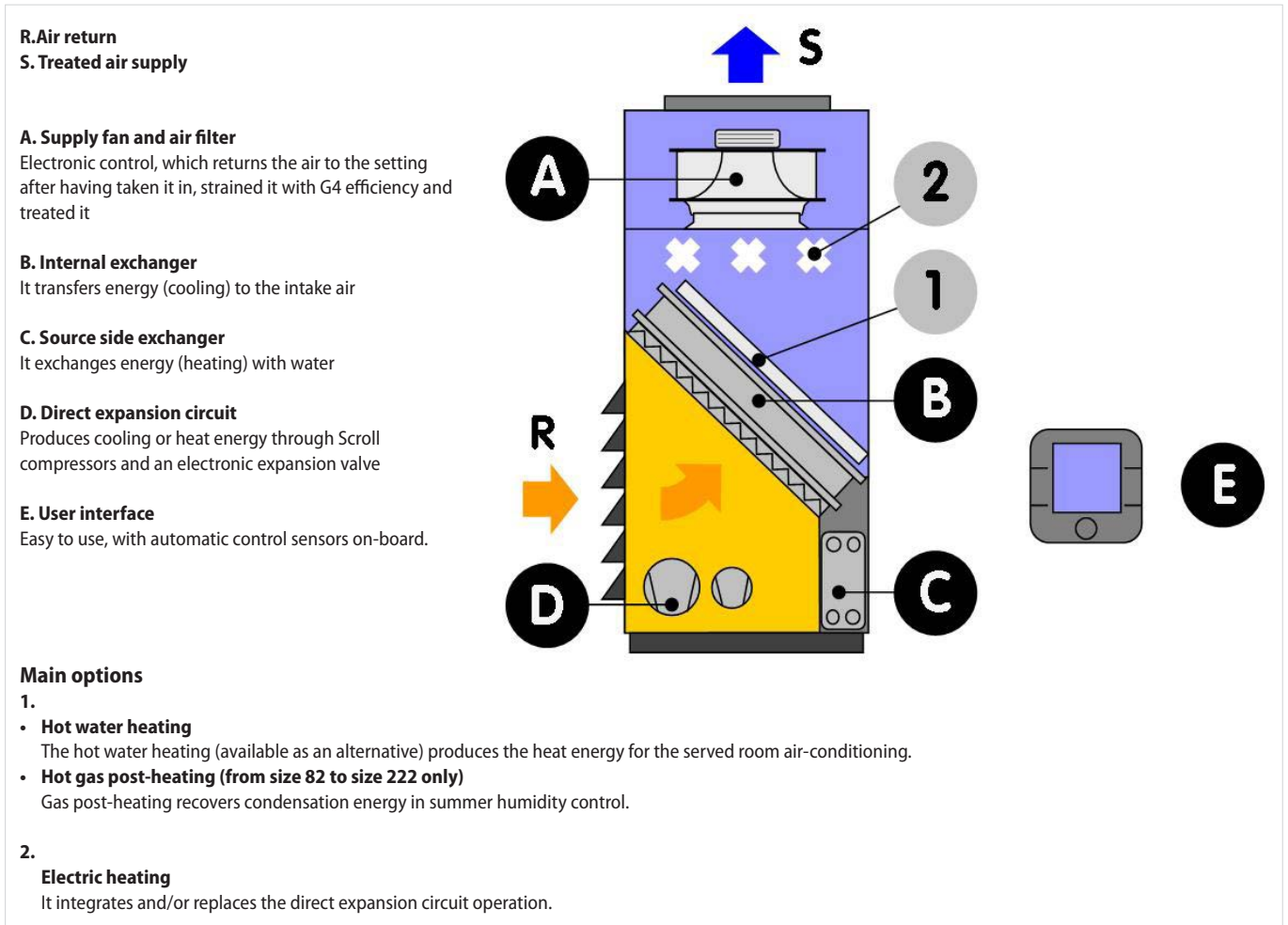

The ordinary maintenance of the main components takes place from the front, thanks to the different dedicated access panels.

Furthermore, the numerous accessories which are available enable the unit to be **personalised**, obtaining functions and performance for the specific system as required.

Easy to position in available settings or technical spaces

ROOMPACK can be **positioned easily** in one of the following settings: Directly in the served ambient, in a visible position; In technical rooms; In service rooms, for instance, warehouses and store rooms.

This versatility is made possible by **the different solutions available for the supply and intake of air**, and due to its numerous combinations.

The most frequently used installation modes are, for instance:

- Installation directly in the served setting or in technical or service rooms, with frontal intake from a free opening via an integrated grille and duct type vertical intake
- Direct installation in the setting, with low intake (from the plenum or raised flooring) and frontal supply using a special optional plenum, complete with a double set of adjustable fins
- Installation in the service room next to the served room, with a rear ducted intake and vertical supply which is also ductable. This is frequently used in commercial applications, where the unit is typically installed in a warehouse (behind the store) with a rear intake which communicates directly with the served setting, and with a ductable supply.

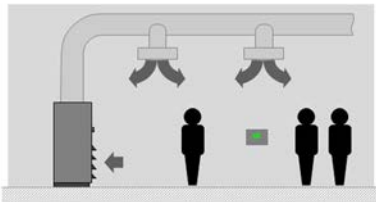

FRONTAL INTAKE AND UPWARD DUCT TYPE SUPPLY

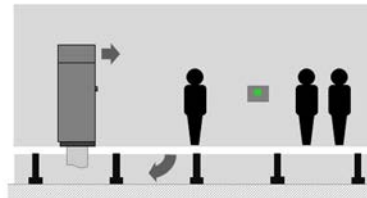

**DUCT TYPE LOW INTAKE AND FRONTAL SUPPLY WITH DEDICATED PLENUM
(from size 82 to size 222 only)**

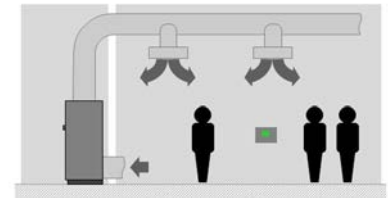

REAR DUCT TYPE INTAKE AND UPWARD DUCT TYPE SUPPLY

This image represents only a few of the numerous positioning possibilities.

Easy to use

The control display is modern and very **easy to use** even for non-specialist users. It also has different levels of password protected access to the management of unit functions.

It is standard for on wall installation, outside the unit. On request it can be supplied for installation in a built-in cover or on the front panel of the unit.

REMOTE INSTALLATION

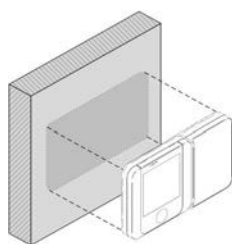

on wall (std)

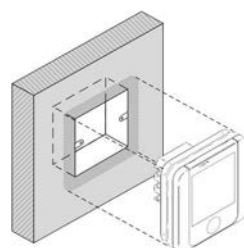

in an uncased box

BUILT-IN INSTALLATION



on the front panel

The reliable, highly energy efficient solution

All the solutions adapted by ROOMPACK for the production of cool energy and for air-conditioning increase energy efficiency with maximum reliability.

Scroll module technology for maximum efficiency at partial loads

Since the maximum power generated by the system is requested only for short periods of time, it is fundamental to dispose of the **maximum efficiency in the conditions of part-load.**

By using only one of the two compressors, efficiency is increased by more than 40%, thanks to the larger heat exchange surfaces.

In addition, the selection of different sized compressors makes it possible to obtain more control steps, providing only the effectively necessary energy for use.

By continuously adapting itself to the inlet air conditions in the environment, this solution also **improves comfortable conditions for the users and operators.**

Single-compressor version: from size 31 to 81

THE USE OF DIFFERENT SIZED COMPRESSORS OPTIMALLY COMPENSATES FOR THE AMBIENT LOAD

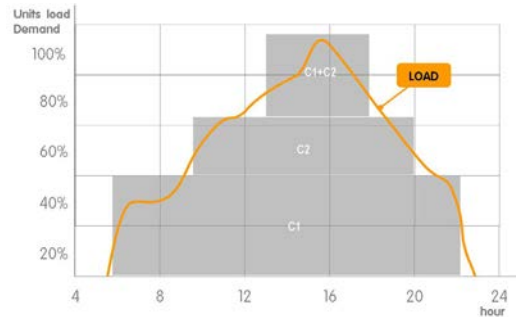

THE SEQUENTIAL DEACTIVATION OF THE COMPRESSORS INCREASES EFFICIENCY



Stable and reliable operating

The electronic expansion valve (EEV) adapts rapidly and precisely to the actual load required for usage, allowing **stable and reliable adjustment.**

This results also in a further **increase in efficiency and longer compressor life.**

The overheating control allows preventing phenomena that are hazardous to the compressors, such as overtemperature and return fluids, thereby increasing even more efficiency and durability.

The electronic expansion valve allows to operate with a lower condensation temperature compared to a mechanic thermostatic valve.

The benefits can be greater than 10% energy savings in temperate climates but are also evident in the hot climates.

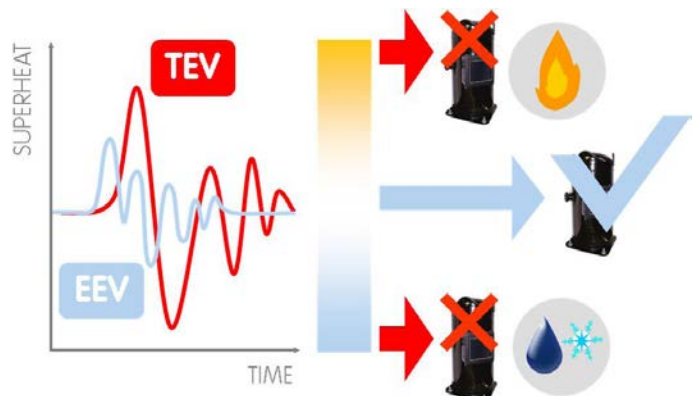

Even more silent composite structure plug-fans

How to improve ventilation whilst reducing prime (electric) energy consumption

A significant portion of the running costs of the fresh air systems is due to the consumption for ventilation. To this there should be added the charge for the study of the correct operating conditions, and for the required long and precise calibrations at the worksite.

The use of fans with PLUG FAN technology allows both of these operational costs to be achieved.

Versatility of reversed blades rotor

This particular type of rotor offers a **wider field of operation** compared with a traditional forward curved blade fan. When necessary, this can supply high static pressures simply by varying the number of revolutions. The accurate balancing and the self-lubricating bearings ensure its rotating stability over time.



The efficiency of the electronic controlled motor

The external rotor electric motor is driven by the continuous magnetic switching of the stator. The advantages are:

The lack of brushes and the particular power supply increase efficiency by 70%;

Even the life cycle increases, thanks to **the elimination of the brushes' natural abrasive erosion effects**;

The electronic control also includes a "soft start" solution, which drastically **reduces the starting current** of the fan and limits even more the system's electrical commitment.



Advantages of direct coupling (plug fan)

The motor's rotation is transmitted directly to the rotor, without **the use of transmissions** (belts and pulleys):

- the transmissions' inefficiencies are eliminated;
- the transmissions' wear and maintenance is eliminated.

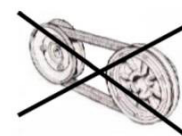

Efficiency of the ventilation system increases by 30%

The comprehensive ventilation system, made up of rotor and motor, is therefore very versatile and efficient.

Consumption is 30% lower than a ventilation system of the same capacity used by traditional units available on the market.

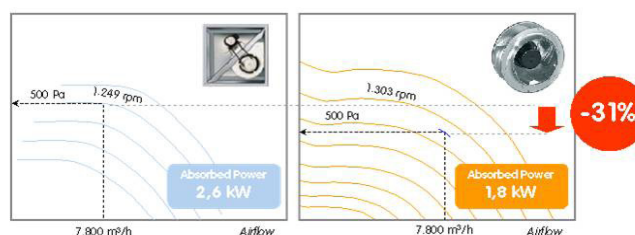

Electrical power absorption from the electric motor, manufacturer data - Example referred to the flow of 7,800 m³/h with static pressure equal to 500 Pa

Higher levels of silence with composite

The fan impeller is made of a hybrid structure with aluminium alloy and plastic, with optimised aerodynamic blades. **Thus electric absorption from the motor is reduced, obtaining a high level of silence whilst operating.**

This further technological progress increases the advantages in comparison with traditional centrifugal fans.



Composite construction except for size 122

The right air flow for every type of system

By setting the fan speed on the display, it is possible to modify the air flow, adapting the head yield to the pressure drop carried out by the system and thus, simplifying the start up of the unit. It is no longer necessary to calibrate or modify the transmissions in as much as it is **the fan system which adapts to the system.**

The possibility to modify the fan start-up ramp makes this **unit suitable for most applications with textile air distribution ducting.**



Highly energy efficient plate exchanger with water source exchange

Universally recognised for its **highly efficient heat exchange** and its compactness, it is complete with a control probe and safety device and is offered with a matching mechanical steel mesh filter which can ensure excellent performance over time.

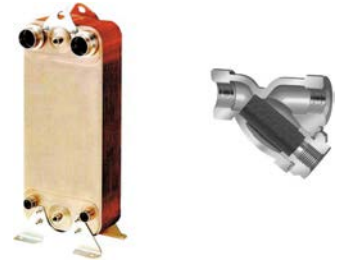

Available also with steel mesh filter

Air quality always under control

Air filtration is a compulsory function in order to correctly maintain conditions of wellness and hygiene in the served environments. For this reason, it is subjected to precise regulations based on the specific applications. The units are provided standard with large surface area and low pressure drop filters with a G4 efficiency level.



Easy to use in the small and large plants

Standard automatic functions

ROOMPACK is complete with automatic room temperature and humidity control:

- it detects the room conditions and compares them with the user set point
- it can automatically choose the operating mode (heating or cooling)
- decides which and how many resources to activate basing on the distance from the determined set-point;

Simple and intuitive user interface

The unit is supplied with an innovative graphic interface as standard pre-set for wall installation (wiring and installation at 230V entrusted to the Client).

During maintenance operations, it may be removed from its support and directly connected to the unit electric panel.

Its main functions include:

- Reading the temperature and humidity using built-in sensors
- Programming working time schedules on a daily/weekly
- Displaying and managing the alarms and operating parameters
- Enabling manual management of the function modes (heating or cooling)

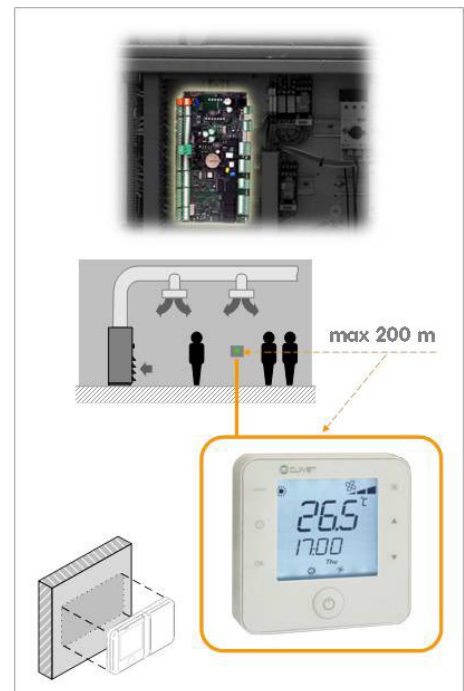

Voltage-free contact user interface

The standard version has a series of **free contacts**, or rather contacts without tension, for remotely managing the following functions: Switching on and switching off, changing function mode (heating or cooling), cumulative alarm.

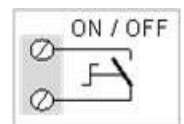

User interface by serial connection

Thanks to the different **communication protocols** available, the unit is able to exchange information with the main supervisory systems using serial connections.



Ready to be connected to the water mains

The system components for connecting the ROOMPACK CAS-X to the hydraulic supply network are **available built in**.

Thanks to their easily accessible position, the installation and the **ordinary maintenance are notably simplified**.

This further increases **reliability**, as the seal and functionality of the components are tested at the end of the production process.

Thanks to the specific plumbing assemblies available, **the unit can be integrated perfectly into different types of hydraulic systems** with loops or from aqueduct water or using waste water.

Each component has been carefully designed to guarantee the maximum operating efficiency and to protect the high efficiency water side exchanger from clogging.

The functions of the standard version

The unit without optional hydraulic pipework arrangement is complete with **plate exchanger and control and safety devices**.

The other system components needed for the connection to the water supply are available as accessories, for installation by the Client:

- steel mesh strainer
- manual shut-off valves
- manual by-pass valve for the system cleaning
- manual balancing valve
- hoses for water supply and condensate drain

Standard unit
(without hydraulic pipework arrangements)

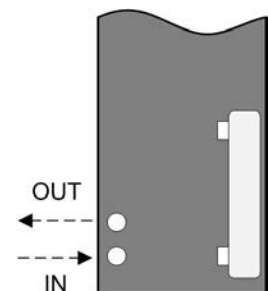

The reliability of the complete hydraulic pipeworks provided built-in

The unit can be supplied with **hydraulic pipeworks built in** with what it is necessary to properly start up and run the system at the different application types: loop with constant or variable flow rate, with aqueduct / disposable water system.

The hydraulic pipeworks allow the unit interception by the system, the washing (flushing) of the system, the reduction of the consumption of water where the system is designed for this purpose.

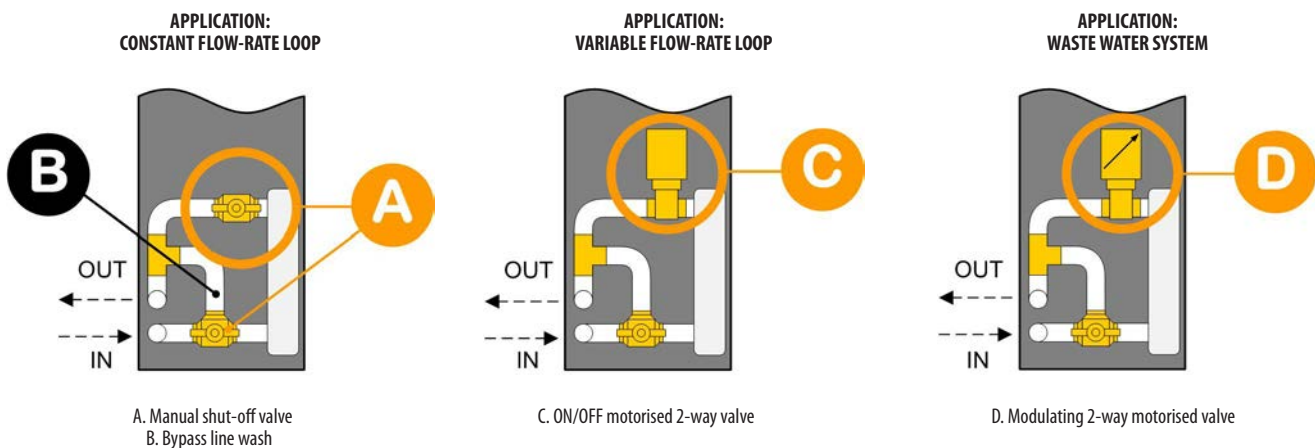

Standard unit technical specifications

Compressor

Hermetic orbiting scroll compressor complete with motor winding and delivery gas over-temperature and over-current devices. Fitted on rubber antivibration mounts and complete with oil charge.

- From size 31 to 81 single compressor
- From size 82 to 222 two compressors are connected in TANDEM on a single refrigeration circuit, with a biphasic oil equalisation.

An oil heater, which starts automatically, keeps the oil from being diluted by the refrigerant when the compressor stops.

Structure

The support base is assembled with a painted galvanized steel frame. The internal structure is made of "ALUZINK" bent galvanized steel. The alloy that protects the Aluzink allow an excellent corrosion proofing thanks to the galvanic protection typical of the combination aluminium-zinc.

Panelling

External panelling with pre-painted panels covered with thermo-insulating and soundproofing material (class 1 flame resistant - DIN 53438).

All panelling can easily be removed to allow complete accessibility to internal components.

Internal exchanger

Direct expansion finned exchanger, made from copper pipes in staggered rows and mechanically expanded to the fin collars. The fins are made from aluminium with a corrugated surface and adequately distanced to ensure the maximum heat exchange efficiency.

External exchanger

Direct expansion heat exchanger with braze welded stainless steel AISI 316 plates and complete with external thermal/anti-condensation insulation, complete with water side differential pressure switch and water temperature control probe.

Fan

Plug fans without scroll with reverse blades driven by electronically-controlled "brushless" dc motors with direct coupling. No transmission sizing is needed.

Refrigeration circuit

Refrigeration circuit with:

- R410A refrigerant charge
- sight glass with moisture and liquid indicator
- high pressure safety pressure switch
- low pressure safety switch
- filter dryer
- electronic expansion valve
- liquid receiver
- high pressure safety valve
- low pressure safety valve

Filtration

Pleated filter for greater filtering surface, made of a galvanized sheet frame with a galvanized and electric-welded protective mesh, and regenerable filtering media made from polyester fibre sized with synthetic resins. G4 efficiency according to CEN-EN 779 standard (Eurovent classification EU4/5 - separation average 90.1% ASHRAE 52-76 Atm). Self-extinguishing type (flame resistant class 1 - DIN 53438).

Drain pan

Condensation collection basin in aluminium alloy 1050 H24 with anti-condensation insulation, welded and equipped with siphoned drain tube

Electrical panel

The electrical panel is located inside the unit and is easily accessible thanks to removable panels.

The capacity section includes:

- main line isolator switch
- compressor power supply remote control switch
- isolating transformer for auxiliary circuit power supply
- auxiliary circuit fuse
- fan motor power supply remote control switch
- fan overload circuit breakers

The control section includes:

- microprocessor control
- treated air temperature control
- compressor overload protection and timer
- self-diagnosis system with immediate display of the error code
- voltage-free contacts for remote ON-OFF, cumulative alarm, fire alarm input, fan state, compressor state, summer/winter mode, 0-10V signal external humidifier management

Wall room electronic control including:

- intuitive graphical interface retro lighted
- temperature and humidity measurement through its internal probes
- modification of the temperature and humidity set point
- Unit On/Off and overload reset
- Switch on and off daily and weekly programmer and set point
- setting of ventilation only operation
- language management for the navigation menu
- display of operating status
- display of alarms and failure code
- management of the operating parameters.
- unit parameter protection with password

Accessories

- Hydraulic pipework arrangement for loop with constant flow rate with manual valves
- Hydraulic pipework arrangement for loop with variable flow rate with 2 way ON-OFF valve
- Plumbing assembly for loop with disposable water system with 2-way modulating valve
- Clogged filter differential pressure switch air side
- two-rows hot water coil
- Modulating 3-way valve - Optional component - Available from size 82 to size 222.
- Hot gas re-heating coil - Available from size 82 to size 222.
- external humidifier control with 0-10V command
- Electronic room control with display, for wall installation in built-in box
- Constant supply airflow
- Temperature control with on-board probe
- Ambient humidity and temperature control with built-in probes
- RS485 serial port with Modbus protocol, built-in
- Electric heaters.
- high and low pressure gauges
- phase monitor
- Power factor correction capacitors (cosfi > 0.9)
- Internal exchanger anti-ice protection heater

Accessories separately supplied

- Front air supply plenum H=500mm
- Air supply plenum on three sides (Available from size 31 to size 81)
- Modulating 3-way valve (Available from size 31 to size 81)
- LonWorks serial communication module
- BACnet serial communication module
- Rubber antivibration mounts
- Steel mesh strainer on the water side (separately supplied accessories)

Test

unit manufactured according to the ISO 9001 quality standards and subject to functional testing at the end of the production line

General technical data

Size			31	41	51	61	71	81	82	102	122	162	182	222
Cooling														
Cooling capacity	1	kW	10.8	12.4	16.0	17.5	20.0	24.8	34.3	39.3	48.1	56.3	66.2	75.7
Sensible capacity	1	kW	8.3	9.8	12.6	13.8	15.0	18.4	27.7	30.8	38.5	45.8	53.3	58.8
Compressor power input	1	kW	1.97	2.3	3.09	3.63	3.83	4.96	6.39	7.44	9.18	10.2	12.2	14.6
EER	1		5.48	5.4	5.18	4.82	5.22	5.0	5.37	5.28	5.24	5.52	5.43	5.18
Compressor														
Type of compressors	2		Scroll	Scroll	Scroll	Scroll	Scroll	Scroll	Scroll	Scroll	Scroll	Scroll	Scroll	Scroll
No. of compressors		No	1	1	1	1	1	1	2	2	2	2	2	2
Std Capacity control steps		No	1	1	1	1	1	1	3	3	2	3	3	3
Refrigeration circuits		No	1	1	1	1	1	1	1	1	1	1	1	1
Air Handling Section Fans (Supply)														
Type of supply fan	3		RAD	RAD	RAD	RAD	RAD	RAD	RAD	RAD	RAD	RAD	RAD	RAD
Number of supply fans		No	1	1	1	1	1	1	1	1	2	2	2	2
Fan diameter		mm	310	310	310	355	355	355	500	500	450	500	500	500
Supply airflow		l/s	569	778	889	1056	1167	1250	1944	2222	2778	3194	3611	4167
Supply airflow		m ³ /h	2050	2800	3200	3800	4200	4500	7000	8000	10000	11500	13000	15000
Installed unit power		kW	0.80	0.80	0.80	0.90	0.90	0.90	2.70	2.70	1.00	2.70	2.70	2.70
Max. static pressure supply fan	4	Pa	700	460	275	365	240	120	450	340	240	540	510	400
External exchanger														
Type of external exchanger	5		PHE	PHE	PHE	PHE	PHE	PHE	PHE	PHE	PHE	PHE	PHE	PHE
Water flow rate (Source Side)		l/s	0.60	0.70	0.90	1.00	1.10	1.40	1.90	2.20	2.70	3.20	3.70	4.30
Power supply														
Standard power supply		V	400/3~/50	400/3~/50	400/3~/50	400/3~/50	400/3~/50	400/3~/50	400/3~/50	400/3~/50	400/3~/50	400/3~/50	400/3~/50	400/3~/50

Performance refers to operation at full re-circulation

DB = dry bulb

WB = wet bulb

1. Ambient air 27°C D.B./19°C W.B. Exchanger water temperature 30°C / 35°C

2. SCROLL = scroll compressor

3. RAD = radial fan

4. Net outside static pressure to win the outlet and intake onboard pressure drops

5. PHE = plate exchanger

Electrical data

Size			31	41	51	61	71	81	82	102	122	162	182	222
F.L.A. - Full load current at max admissible conditions														
F.L.A. - Compressor 1		A	5.50	5.70	7.30	9.20	9.90	12.5	9.80	9.80	14.3	15.2	15.2	15.2
F.L.A. - Compressor 2		A	-	-	-	-	-	-	10.2	14.3	14.3	17.3	22.8	30.9
F.L.A. - Single supply fan		A	1.60	1.60	1.60	1.70	1.70	1.70	4.30	4.30	2.20	4.30	4.30	4.30
F.L.A. - Total	1	A	7.60	7.80	9.40	11.4	12.1	14.7	24.8	28.9	33.5	41.6	47.1	55.2
L.R.A. - Locked rotor amperes														
L.R.A. - Compressor 1		A	46.0	43.0	54.5	74.0	75.0	101	64.0	64.0	101	95.0	95.0	95.0
L.R.A. - Compressor 2		A	-	-	-	-	-	-	64.0	101	101	111	118	174
F.L.I. - Full load power input at max admissible conditions														
F.L.I. - Compressor 1		kW	3.00	3.40	4.30	5.30	5.70	6.90	5.90	5.90	8.30	8.90	8.90	8.90
F.L.I. - Compressor 2		kW	-	-	-	-	-	-	6.00	8.30	8.30	9.90	13.4	17.2
F.L.I. - Single supply fan		kW	0.80	0.80	0.80	0.90	0.90	0.90	2.70	2.70	1.00	2.70	2.70	2.70
F.L.I. - Total	2	kW	4.10	4.50	5.50	6.50	6.90	8.10	14.9	17.2	18.9	24.5	28.0	31.8
M.I.C. Maximum inrush current														
M.I.C. - Value		A	55.1	52.3	62.4	87.1	88.8	117	78.6	115.6	120.2	135.3	142.3	198.3

Data refer to standard units.

- Power supply: 400/3/50 Hz. Voltage variation: max. +/-10%

- Voltage unbalance between phases: max 2 %

1. Values not including the accessories. To obtain the value of F.L.A. including accessories, add to the total F.L.A. value that of any accessories (see electrical data of accessories)

2. Values not including the accessories. To obtain the value of F.L.I. including accessories, add to the total F.L.I. value that of any accessories (see electrical data of accessories)

Electrical input of optional components

To obtain the electrical input of the unit including accessories, add the standard data in Electrical Data table to those for the selected accessories.

SIZES			31	41	51	61	71	81	82	102	122	162	182	222
F.L.A. ABSORBED CURRENT														
F.L.A. EH09 - 4,5 kW electric elements		A	6.5	6.5	6.5	6.5	6.5	6.5	-	-	-	-	-	-
F.L.A. EH06 - 6 kW electric elements		A	8.7	8.7	8.7	8.7	8.7	8.7	-	-	-	-	-	-
F.L.A. EH12 - 9 kW electric elements		A	13.0	13.0	13.0	13.0	13.0	13.0	-	-	-	-	-	-
F.L.A. EH14 - 12 kW electric elements		A	17.3	17.3	17.3	17.3	17.3	17.3	17.3	17.3	17.3	17.3	-	-
F.L.A. EH17 - 18 kW electric elements		A	-	-	-	26.0	26.0	26.0	26.0	26.0	26.0	26.0	26.0	26.0
F.L.A. EH22 - 27 kW electric elements		A	-	-	-	-	-	-	39.0	39.0	39.0	39.0	39.0	39.0
F.L.A. EH24 - 36 kW Heating elements		A	-	-	-	-	-	-	-	-	-	-	52.0	52.0
F.L.I. POWER INPUT														
F.L.I. EH09 - Electric elements of 4,5 kW		kW	4.5	4.5	4.5	4.5	4.5	4.5	-	-	-	-	-	-
F.L.I. EH06 - 6 kW electric elements		kW	6.0	6.0	6.0	6.0	6.0	6.0	-	-	-	-	-	-
F.L.I. EH12 - Electric elements of 9 kW		kW	9.0	9.0	9.0	9.0	9.0	9.0	-	-	-	-	-	-
F.L.I. EH14 - Electric elements of 12 kW		kW	12.0	12.0	12.0	12.0	12.0	12.0	12.0	12.0	12.0	12.0	-	-
F.L.I. EH17 - Electric elements of 18 kW		kW	-	-	-	18.0	18.0	18.0	18.0	18.0	18.0	18.0	18.0	18.0
F.L.I. EH22 - 27 kW electric elements		kW	-	-	-	-	-	-	27.0	27.0	27.0	27.0	27.0	27.0
F.L.I. EH24 - 36 kW heating elements		kW	-	-	-	-	-	-	-	-	-	-	36.0	36.0

Sound levels

SIZES	Sound Power Level (dB)								Sound pressure level dB(A)	Sound power level dB(A)
	Octave band (Hz)									
	63	125	250	500	1000	2000	4000	8000		
31	68	68	70	64	63	62	51	48	53	68
41	71	71	73	66	64	64	53	50	55	70
51	72	72	75	68	66	66	56	51	57	72
61	74	74	77	70	68	68	58	53	59	74
71	76	75	80	72	70	69	60	54	61	76
81	78	77	82	74	72	71	62	55	63	78
82	67	72	79	74	71	67	59	54	60	76
102	70	75	82	77	74	70	62	56	63	79
122	67	74	78	75	71	66	54	54	59	76
162	68	73	80	75	72	69	59	56	61	78
182	70	75	82	77	74	71	62	57	63	80
222	73	77	85	80	77	73	66	60	65	82

The sound levels are referred to unit operating at full load in nominal conditions.

The sound pressure level is referred to a distance of 1 m. from the ducted unit surface operating in free field conditions.

External static pressure 50 Pa.

Measurements are made in accordance to the UNI EN ISO 9614-2.

Please note that when the unit is installed in conditions different from nominal test conditions (e.g. near walls or obstacles in general), the sound levels may undergo substantial variations..

Operating range (Cooling)

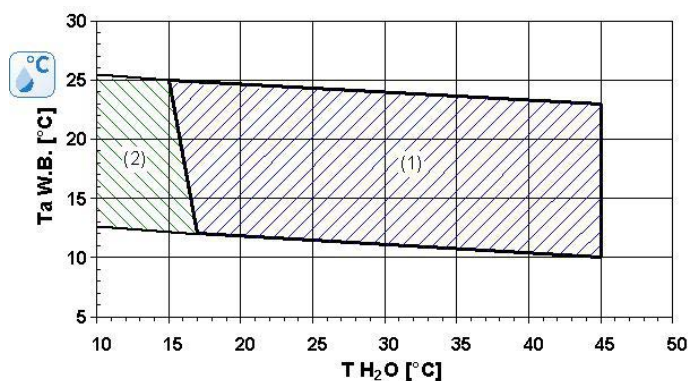

The limits are meant as a guide. Please note that they have been calculated by considering:

- general and non specific sizes
- standard airflow
- non-critical positioning and correct use of the unit operation at full load
- difference between inlet / outlet water temperature = 5°C

Ta = entering handling coil air temperature (°C)
WARNING! WET BULB TEMPERATURE
 (W.B. = WET BULB)

TH2O = Water temperature at plate exchanger input (°C)

1. Standard operating range
2. Field of use for unit equipped with plumbing assembly for waste water system (Optional)

Example
 Wet bulb temperature



19°C W.B. 24°C D.B. / 63% R.H.
 26°C D.B. / 52% R.H.
 27°C D.B. / 48% R.H.

Performances in cooling

Standard airflow

Size		31	41	51	61	71	81	82	102	122	162	182	222
Airflow	l/s	569	778	889	1056	1167	1250	1944	2222	2778	3194	3611	4167
Airflow	m ³ /h	2050	2800	3200	3800	4200	4500	7000	8000	10000	11500	13000	15000
Max external static pressure	Pa	700	460	275	365	240	120	450	340	240	540	510	400

SIZES	Ta (°C) DB/WB	CAPACITY STEPS	LEAVING EXCHANGER WATER TEMPERATURE (°C) - TEMPERATURE DIFFERENTIAL 5°C																											
			25				30				35				40				45				50							
			kWf	kWe	kWs	EER	kWf	kWe	kWs	EER	kWf	kWe	kWs	EER	kWf	kWe	kWs	EER	kWf	kWe	kWs	EER	kWf	kWe	kWs	EER				
31	22 / 16	C1	10,1	1,76	7,5	5,73	10,0	1,84	7,5	5,42	9,8	1,96	7,4	4,98	9,5	2,13	7,4	4,46	9,1	2,34	7,3	3,90	8,7	2,59	7,3	3,35				
	24 / 17	C1	10,4	1,75	8,0	5,94	10,3	1,84	7,9	5,60	10,1	1,96	7,9	5,14	9,8	2,13	7,8	4,59	9,4	2,34	7,8	4,02	9,0	2,60	7,7	3,46				
	26 / 18	C1	10,8	1,75	8,5	6,15	10,6	1,84	8,4	5,78	10,4	1,97	8,3	5,29	10,1	2,14	8,3	4,73	9,7	2,35	8,2	4,14	9,3	2,60	8,2	3,56				
	27 / 19	C1	11,2	1,75	8,5	6,37	11,0	1,84	8,4	5,97	10,8	1,97	8,3	5,45	10,4	2,14	8,3	4,87	10,0	2,36	8,2	4,26	9,6	2,61	8,1	3,67				
	28 / 20	C1	11,5	1,75	8,5	6,59	11,4	1,84	8,4	6,16	11,1	1,98	8,4	5,61	10,8	2,15	8,3	5,01	10,4	2,36	8,2	4,39	9,9	2,61	8,1	3,78				
	30 / 22	C1	12,3	1,75	8,8	7,04	12,1	1,85	8,6	6,54	11,8	1,99	8,5	5,94	11,5	2,17	8,3	5,30	11,0	2,38	8,2	4,64	10,5	2,63	8,1	4,00				
41	22 / 16	C1	11,8	2,03	8,9	5,82	11,6	2,13	8,8	5,44	11,3	2,29	8,7	4,95	11,0	2,50	8,7	4,38	10,5	2,77	8,6	3,80	10,0	3,09	8,5	3,24				
	24 / 17	C1	12,2	2,02	9,5	6,02	12,0	2,13	9,4	5,61	11,7	2,29	9,3	5,09	11,3	2,51	9,2	4,51	10,9	2,77	9,1	3,91	10,3	3,09	9,0	3,34				
	26 / 18	C1	12,6	2,02	10,0	6,23	12,3	2,13	9,9	5,79	12,0	2,30	9,8	5,24	11,7	2,51	9,7	4,64	11,2	2,78	9,6	4,03	10,7	3,10	9,5	3,45				
	27 / 19	C1	13,0	2,01	10,0	6,46	12,7	2,13	9,9	5,98	12,4	2,30	9,8	5,40	12,0	2,51	9,6	4,78	11,6	2,78	9,5	4,15	11,0	3,10	9,4	3,56				
	28 / 20	C1	13,4	2,00	9,9	6,70	13,1	2,12	9,8	6,19	12,8	2,30	9,6	5,58	12,4	2,52	9,5	4,93	11,9	2,78	9,3	4,28	11,4	3,10	9,2	3,67				
	30 / 22	C1	14,3	1,98	9,7	7,22	14,0	2,11	9,5	6,65	13,7	2,29	9,2	5,97	13,2	2,51	9,0	5,26	12,7	2,79	8,8	4,56	12,2	3,11	8,6	3,91				
51	22 / 16	C1	15,9	2,40	11,7	6,62	15,2	2,71	11,4	5,60	14,5	3,08	11,1	4,71	13,8	3,48	10,9	3,95	13,0	3,94	10,6	3,31	12,3	4,45	10,3	2,77				
	24 / 17	C1	16,3	2,40	12,4	6,80	15,7	2,72	12,2	5,76	15,0	3,08	11,9	4,86	14,3	3,49	11,6	4,09	13,5	3,94	11,3	3,44	12,8	4,44	11,0	2,88				
	26 / 18	C1	16,8	2,41	13,2	6,98	16,1	2,72	12,9	5,93	15,5	3,08	12,6	5,01	14,8	3,49	12,3	4,23	14,0	3,94	12,0	3,56	13,3	4,43	11,7	2,99				
	27 / 19	C1	17,3	2,41	13,2	7,18	16,6	2,73	12,9	6,10	16,0	3,09	12,6	5,17	15,3	3,49	12,3	4,37	14,5	3,94	12,0	3,69	13,7	4,42	11,7	3,10				
	28 / 20	C1	17,8	2,41	13,1	7,38	17,2	2,73	12,8	6,28	16,5	3,10	12,6	5,33	15,8	3,50	12,3	4,51	15,0	3,94	12,0	3,81	14,2	4,41	11,7	3,21				
	30 / 22	C1	18,9	2,42	13,0	7,82	18,3	2,75	12,7	6,65	17,6	3,11	12,4	5,64	16,8	3,51	12,1	4,78	15,9	3,94	11,8	4,05	15,0	4,40	11,5	3,41				
61	22 / 16	C1	17,1	2,88	12,5	5,95	16,6	3,20	12,2	5,17	15,9	3,59	11,8	4,43	15,2	4,04	11,5	3,75	14,3	4,57	11,2	3,14	13,4	5,16	10,8	2,60				
	24 / 17	C1	17,7	2,89	13,4	6,11	17,1	3,22	13,1	5,32	16,4	3,60	12,7	4,56	15,7	4,06	12,4	3,86	14,8	4,58	12,1	3,23	13,9	5,17	11,7	2,68				
	26 / 18	C1	18,3	2,91	14,4	6,28	17,6	3,23	14,1	5,47	16,9	3,62	13,7	4,69	16,2	4,07	13,4	3,97	15,3	4,59	13,0	3,33	14,3	5,18	12,7	2,77				
	27 / 19	C1	18,8	2,92	14,4	6,45	18,2	3,24	14,1	5,62	17,5	3,63	13,8	4,82	16,7	4,08	13,4	4,09	15,8	4,60	13,1	3,43	14,8	5,18	12,7	2,86				
	28 / 20	C1	19,4	2,93	14,3	6,62	18,8	3,25	14,0	5,78	18,1	3,64	13,7	4,97	17,2	4,08	13,3	4,22	16,3	4,60	13,0	3,54	15,3	5,18	12,6	2,95				
	30 / 22	C1	20,6	2,96	13,5	6,97	20,0	3,27	13,1	6,11	19,2	3,65	12,8	5,27	18,3	4,09	12,4	4,49	17,3	4,59	12,1	3,78	16,2	5,16	11,7	3,14				
71	22 / 16	C1	19,1	3,27	13,9	5,83	18,7	3,46	13,6	5,41	18,2	3,79	13,3	4,81	17,5	4,24	13,0	4,12	16,6	4,83	12,6	3,43	15,4	5,55	12,3	2,78				
	24 / 17	C1	19,6	3,28	14,7	5,98	19,3	3,47	14,4	5,55	18,8	3,80	14,1	4,94	18,0	4,26	13,8	4,24	17,1	4,84	13,5	3,53	15,9	5,56	13,2	2,87				
	26 / 18	C1	20,2	3,29	15,6	6,14	19,9	3,49	15,3	5,70	19,4	3,82	15,0	5,07	18,6	4,27	14,7	4,35	17,6	4,86	14,4	3,63	16,4	5,57	14,0	2,95				
	27 / 19	C1	20,8	3,30	15,6	6,31	20,5	3,50	15,3	5,85	20,0	3,83	15,0	5,21	19,2	4,29	14,7	4,47	18,2	4,87	14,3	3,73	17,0	5,58	14,0	3,04				
	28 / 20	C1	21,5	3,32	15,5	6,49	21,2	3,52	15,2	6,01	20,6	3,85	14,9	5,35	19,8	4,30	14,6	4,60	18,8	4,89	14,3	3,84	17,5	5,60	13,9	3,13				
	30 / 22	C1	23,0	3,35	14,9	6,88	22,6	3,55	14,6	6,36	21,9	3,88	14,3	5,65	21,0	4,33	14,0	4,85	19,9	4,92	13,7	4,05	18,6	5,62	13,4	3,31				
81	22 / 16	C1	23,7	4,15	17,3	5,70	23,6	4,43	16,9	5,32	23,0	4,88	16,5	4,72	22,1	5,49	16,1	4,02	20,7	6,28	15,7	3,30	18,9	7,23	15,3	2,61				
	24 / 17	C1	24,5	4,17	18,2	5,88	24,2	4,46	17,8	5,43	23,5	4,91	17,5	4,80	22,5	5,52	17,1	4,08	21,2	6,30	16,7	3,36	19,5	7,24	16,3	2,69				
	26 / 18	C1	25,4	4,19	19,2	6,06	24,9	4,48	18,8	5,55	24,1	4,93	18,4	4,89	23,1	5,54	18,0	4,16	21,7	6,31	17,6	3,44	20,1	7,24	17,3	2,77				
	27 / 19	C1	26,3	4,21	19,2	6,24	25,6	4,51	18,8	5,68	24,7	4,96	18,4	4,99	23,6	5,57	18,0	4,25	22,3	6,33	17,6	3,52	20,7	7,25	17,2	2,86				
	28 / 20	C1	27,1	4,24	19,2	6,41	26,4	4,54	18,8	5,82	25,4	4,99	18,4	5,10	24,3	5,59	18,0	4,34	22,9	6,34	17,6	3,62	21,4	7,25	17,2	2,95				
	30 / 22	C1	28,9	4,28	19,1	6,74	28,0	4,58	18,8	6,11	27,0	5,03	18,4	5,36	25,7	5,62	18,0	4,58	24,4	6,36	17,7	3,83	22,8	7,25	17,3	3,15				

Performance refers to operation at full re-circulation
 C1,C2 indicate the active compressors and then reliable capacity steps

Ta = entering handling coil air temperature (°C)
 DB = dry bulb
 WB = wet bulb

kWf = Cooling capacity in kW
 kWe = Compressor power input in kW
 kWs = sensible cooling capacity (kW)

EER referred only to compressors

Performance values do not include the effect of fan motor heat

SIZES	Ta (°C) DB/ WB	CAPACITY STEPS	LEAVING EXCHANGER WATER TEMPERATURE (°C) - TEMPERATURE DIFFERENTIAL 5°C																							
			25				30				35				40				45				50			
			kWf	kWe	kWs	EER	kWf	kWe	kWs	EER	kWf	kWe	kWs	EER	kWf	kWe	kWs	EER	kWf	kWe	kWs	EER	kWf	kWe	kWs	EER
82	22 / 16	C1	18,4	2,19	16,8	8,38	17,6	2,51	16,4	7,01	16,9	2,87	16,0	5,88	16,1	3,25	15,7	4,95	15,3	3,67	15,3	4,18	14,5	4,11	14,5	3,53
		C2	20,3	2,76	17,6	7,35	19,5	3,06	17,2	6,38	18,7	3,40	16,9	5,49	17,8	3,80	16,5	4,68	16,8	4,25	16,2	3,96	15,8	4,76	15,8	3,33
		C1+C2	33,8	4,99	25,7	6,77	32,6	5,62	25,1	5,80	31,2	6,33	24,5	4,93	29,8	7,14	23,8	4,17	28,4	8,03	23,2	3,54	26,9	9,01	22,6	2,99
	24 / 17	C1	-	-	-	-	18,3	2,52	17,9	7,26	17,5	2,88	17,5	6,09	16,8	3,26	16,8	5,15	16,1	3,67	16,1	4,38	15,4	4,11	15,4	3,75
		C2	20,9	2,77	19,2	7,54	20,2	3,06	18,9	6,58	19,3	3,41	18,5	5,68	18,4	3,80	18,2	4,85	17,5	4,25	17,5	4,11	16,4	4,75	16,4	3,46
		C1+C2	35,0	5,01	27,4	6,99	33,6	5,64	26,8	5,96	32,2	6,35	26,2	5,07	30,8	7,15	25,6	4,31	29,3	8,04	25,0	3,64	27,8	9,01	24,4	3,09
	26 / 18	C1	-	-	-	-	18,9	2,52	18,9	7,49	18,1	2,88	18,1	6,28	17,4	3,27	17,4	5,32	16,7	3,68	16,7	4,54	16,1	4,12	16,1	3,91
		C2	21,6	2,78	20,8	7,76	20,8	3,07	20,4	6,79	20,0	3,41	20,0	5,86	19,1	3,80	19,1	5,02	18,1	4,25	18,1	4,26	17,0	4,74	17,0	3,58
		C1+C2	36,1	5,02	29,0	7,19	34,7	5,66	28,4	6,13	33,3	6,37	27,8	5,23	31,8	7,17	27,2	4,44	30,2	8,05	26,6	3,75	28,7	9,02	26,0	3,18
	27 / 19	C1	-	-	-	-	19,4	2,52	19,4	7,71	18,7	2,89	18,7	6,46	17,9	3,28	17,9	5,46	17,2	3,69	17,2	4,66	16,5	4,12	16,5	4,00
		C2	22,3	2,79	20,7	8,00	21,5	3,07	20,3	7,00	20,6	3,41	20,0	6,05	19,7	3,80	19,6	5,18	18,6	4,24	18,6	4,40	17,5	4,73	17,5	3,71
		C1+C2	37,3	5,04	28,9	7,40	35,8	5,67	28,3	6,31	34,3	6,39	27,7	5,37	32,8	7,19	27,1	4,56	31,2	8,06	26,4	3,87	29,6	9,02	25,8	3,28
28 / 20	C1	-	-	-	-	20,0	2,53	19,6	7,90	19,2	2,90	19,2	6,62	18,3	3,28	18,3	5,58	17,5	3,69	17,5	4,73	16,6	4,12	16,6	4,03	
	C2	23,1	2,79	20,5	8,27	22,2	3,07	20,2	7,21	21,2	3,41	19,8	6,23	20,2	3,79	19,4	5,33	19,2	4,23	19,0	4,53	18,1	4,71	18,1	3,83	
	C1+C2	38,4	5,06	28,8	7,59	37,0	5,69	28,2	6,50	35,5	6,41	27,6	5,54	33,9	7,20	26,9	4,71	32,2	8,07	26,3	3,99	30,5	9,02	25,7	3,38	
30 / 22	C2	-	-	-	-	23,6	3,07	19,4	7,67	22,4	3,40	19,0	6,59	21,3	3,78	18,5	5,63	-	-	-	-	-	-	-	-	
	C1+C2	40,7	5,10	28,9	7,98	39,3	5,73	28,2	6,86	37,8	6,44	27,5	5,87	36,2	7,22	26,9	5,01	34,4	8,08	26,2	4,26	32,5	9,00	25,5	3,61	
102	22 / 16	C1	18,7	2,18	17,7	8,56	18,0	2,51	17,3	7,15	17,2	2,87	17,0	6,00	16,5	3,26	16,5	5,06	15,7	3,67	15,7	4,27	14,8	4,11	14,8	3,60
		C2	25,6	3,55	20,8	7,21	24,7	3,96	20,4	6,23	23,7	4,42	20,0	5,36	22,6	4,93	19,6	4,59	21,5	5,49	19,2	3,92	20,3	6,11	18,8	3,33
		C1+C2	38,4	5,80	29,2	6,62	37,1	6,53	28,5	5,68	35,7	7,35	27,8	4,86	34,2	8,27	27,1	4,14	32,5	9,29	26,3	3,50	30,6	10,40	25,6	2,94
	24 / 17	C1	-	-	-	-	18,7	2,52	18,7	7,43	17,9	2,88	17,9	6,23	17,2	3,26	17,2	5,26	16,4	3,67	16,4	4,46	15,6	4,11	15,6	3,79
		C2	20,3	6,11	18,8	3,33	25,5	3,99	22,1	6,39	24,5	4,44	21,6	5,51	23,4	4,95	21,2	4,72	22,2	5,51	20,8	4,03	20,9	6,12	20,3	3,42
		C1+C2	39,6	5,83	30,9	6,79	38,4	6,55	30,1	5,86	36,9	7,37	29,4	5,01	35,3	8,29	28,7	4,26	33,5	9,31	28,0	3,60	31,6	10,40	27,2	3,04
	26 / 18	C1	-	-	-	-	19,3	2,52	19,3	7,68	18,6	2,89	18,6	6,43	17,8	3,27	17,8	5,44	17,0	3,68	17,0	4,62	16,2	4,11	16,2	3,95
		C2	27,2	3,60	24,2	7,55	26,3	4,01	23,7	6,56	25,3	4,47	23,3	5,66	24,1	4,97	22,8	4,85	22,9	5,53	22,3	4,14	21,6	6,13	21,6	3,52
		C1+C2	40,9	5,86	32,4	6,98	39,6	6,58	31,7	6,02	38,1	7,40	31,0	5,15	36,4	8,32	30,2	4,38	34,6	9,33	29,5	3,71	32,7	10,40	28,8	3,14
	27 / 19	C1	-	-	-	-	19,9	2,52	19,9	7,90	19,1	2,89	19,1	6,61	18,3	3,28	18,3	5,59	17,5	3,69	17,5	4,75	17,5	3,69	17,5	4,75
		C2	28,1	3,63	24,3	7,73	27,1	4,04	23,8	6,72	26,1	4,49	23,3	5,81	24,9	4,99	22,7	4,99	23,7	5,55	22,2	4,27	22,3	6,15	21,7	3,62
		C1+C2	42,2	5,89	32,3	7,16	40,8	6,62	31,6	6,16	39,3	7,44	30,8	5,28	37,6	8,35	30,1	4,50	35,7	9,35	29,3	3,82	33,7	10,50	28,6	3,21
28 / 20	C1	-	-	-	-	20,4	2,53	20,4	8,09	19,6	2,90	19,6	6,77	18,8	3,29	18,8	5,71	-	-	-	-	-	-	-	-	
	C2	29,0	3,67	24,5	7,91	28,0	4,06	23,9	6,89	26,9	4,51	23,3	5,96	25,7	5,02	22,7	5,13	24,5	5,57	22,1	4,39	23,1	6,18	21,5	3,74	
	C1+C2	43,5	5,93	32,4	7,34	42,1	6,66	31,6	6,32	40,5	7,48	30,9	5,41	38,8	8,39	30,1	4,62	36,9	9,38	29,4	3,93	34,8	10,50	28,6	3,31	
30 / 22	C2	31,0	3,74	25,2	8,28	29,8	4,12	24,4	7,23	28,6	4,56	23,5	6,28	27,4	5,06	22,7	5,42	26,2	5,62	21,9	4,66	24,9	6,23	21,0	4,00	
	C1+C2	46,1	6,00	33,4	7,68	44,5	6,75	32,6	6,59	42,8	7,58	31,8	5,65	41,1	8,48	31,0	4,85	39,2	9,46	30,3	4,14	37,2	10,50	29,5	3,54	
122	22 / 16	C1	27,1	3,61	24,4	7,53	26,2	4,00	24,0	6,53	25,1	4,46	23,5	5,63	24,0	4,97	23,1	4,82	22,8	5,54	22,6	4,11	21,5	6,16	21,5	3,49
		C2	27,1	3,61	24,4	7,53	26,2	4,00	24,0	6,53	25,1	4,46	23,5	5,63	24,0	4,97	23,1	4,82	22,8	5,54	22,6	4,11	21,5	6,16	21,5	3,49
		C1+C2	47,3	7,21	36,6	6,56	45,7	8,04	35,7	5,68	44,0	8,99	34,8	4,89	42,0	10,10	33,8	4,16	39,8	11,20	32,9	3,55	37,4	12,50	31,9	2,99
	24 / 17	C1	28,1	3,64	26,8	7,71	27,1	4,04	26,4	6,72	26,1	4,49	25,9	5,82	25,0	5,00	25,0	5,01	23,9	5,56	23,9	4,30	22,7	6,19	22,7	3,67
		C2	28,1	3,64	26,8	7,71	27,1	4,04	26,4	6,72	26,1	4,49	25,9	5,82	25,0	5,00	25,0	5,01	23,9	5,56	23,9	4,30	22,7	6,19	22,7	3,67
		C1+C2	48,8	7,26	38,7	6,72	47,2	8,10	37,7	5,83	45,3	9,06	36,8	5,00	43,3	10,10	35,8	4,29	41,0	11,30	34,9	3,63	38,6	12,60	33,9	3,06
	26 / 18	C1	29,0	3,67	29,0	7,88	28,0	4,06	28,0	6,89	27,0	4,51	27,0	5,98	25,9	5,02	25,9	5,17	24,8	5,59	24,8	4,44	23,7	6,21	23,7	3,81
		C2	29,0	3,67	29,0	7,88	28,0	4,06	28,0	6,89	27,0	4,51	27,0	5,98	25,9	5,02	25,9	5,17	24,8	5,59	24,8	4,44	23,7	6,21	23,7	3,81
		C1+C2	50,4	7,31	40,6	6,89	48,6	8,16	39,6	5,96	46,7	9,12	38,7	5,12	44,6	10,20	37,7	4,37	42,3	11,30	36,8	3,74	39,9	12,60	35,8	3,17
	27 / 19	C1	29,8	3,70	29,1	8,06	28,8	4,09	28,6	7,05	27,8	4,54	27,8	6,13	26,7	5,04	26,7	5,30	25,6	5,61	25,6	4,56	24,4	6,23	24,4	3,91
		C2	29,8	3,70	29,1	8,06	28,8	4,09	28,6	7,05	27,8	4,54	27,8	6,13	26,7	5,04	26,7	5,30	25,6	5,61	25,6	4,56	24,4	6,23	24,4	3,91
		C1+C2	51,9	7,37	40,4	7,04	50,1	8,22	39,4	6,09	48,1	9,18	38,5	5,24	46,0	10,20	37,5	4,51	43,7	11,40	36,6	3,83	41,2	12,70	35,7	3,24
28 / 20	C1	30,7	3,73	29,0	8,23	29,6	4,11	28,5	7,20	28,5	4,56	28,0	6,25	27,3	5,06	27,3	5,40	26,1	5,62	26,1	4,64	24,8	6,24	24,8	3,98	
	C2	30,7	3,73	29,0	8,23	29,6	4,11	28,5	7,20	28,5	4,56	28,0	6,25	27,3	5,06	27,3	5,40	26,1	5,62	26,1	4,64	24,8	6,24	24,8	3,98	
	C1+C2	53,5	7,43	40,5	7,20	51,6	8,28	39,5	6,23	49,6	9,23	38,6	5,37	47,4	10,30	37,7	4,60	45,1	11,40	36,8	3,96	42,6	12,70	35,8	3,35	
30 / 22	C1	32,3	3,78	28,6	8,56	31,0	4,15	28,2	7,46	29,6	4,59	27,7	6,45	-	-	-	-	-	-	-	-	-	-	-	-	
	C2	32,3	3,78	28,6	8,56	31,0	4,15	28,2	7,46	29,6	4,59	27,7	6,45	-	-	-	-	-	-	-	-	-	-	-	-	
	C1+C2	56,8	7,56	42,2	7,51	54,8	8,40	41,4	6,52	52,7	9,35	40,5	5,64	50,5	10,40	39,7	4,86	48,1	11,50	38,8	4,18</					

Reduced airflow

Size		31	41	51	61	71	81	82	102	122	162	182	222
Airflow	l/s	456	622	711	844	933	1000	1556	1778	2222	2556	2889	3333
Airflow	m ³ /h	1640	2240	2560	3040	3360	3600	5600	6400	8000	9200	10400	12000
Max external static pressure	Pa	700	630	500	525	445	370	600	520	350	610	610	550

SIZES	Ta (°C) DB/WB	LEAVING EXCHANGER WATER TEMPERATURE (°C) - TEMPERATURE DIFFERENTIAL 5°C																							
		25				30				35				40				45				50			
		kWf	kWe	kWs	EER	kWf	kWe	kWs	EER	kWf	kWe	kWs	EER	kWf	kWe	kWs	EER	kWf	kWe	kWs	EER	kWf	kWe	kWs	EER
31	24 / 17	10,1	1,76	7,5	5,73	9,9	1,84	7,4	5,42	9,7	1,96	7,2	4,98	9,5	2,13	7,1	4,46	9,1	2,34	7,0	3,91	8,7	2,60	6,9	3,36
	26 / 18	10,4	1,75	7,9	5,93	10,3	1,84	7,8	5,59	10,1	1,96	7,7	5,13	9,8	2,13	7,5	4,59	9,4	2,34	7,4	4,02	9,0	2,60	7,3	3,47
	27 / 19	10,8	1,75	7,9	6,14	10,6	1,84	7,8	5,77	10,4	1,97	7,7	5,28	10,1	2,14	7,5	4,73	9,7	2,35	7,4	4,14	9,3	2,60	7,2	3,57
	28 / 20	11,1	1,75	7,9	6,36	11,0	1,84	7,8	5,96	10,7	1,97	7,6	5,44	10,4	2,14	7,5	4,86	10,1	2,36	7,4	4,27	9,6	2,61	7,2	3,68
	30 / 22	11,9	1,75	7,9	6,80	11,7	1,85	7,8	6,34	11,4	1,98	7,6	5,77	11,1	2,16	7,5	5,15	10,7	2,37	7,4	4,51	10,2	2,62	7,2	3,90
	32 / 24	12,7	1,75	7,9	7,27	12,5	1,85	7,8	6,73	12,2	2,00	7,6	6,10	11,8	2,17	7,5	5,44	11,4	2,39	7,3	4,77	10,9	2,63	7,2	4,12
41	24 / 17	11,8	2,03	8,9	5,80	11,6	2,14	8,7	5,42	11,3	2,30	8,6	4,92	11,0	2,51	8,4	4,37	10,5	2,77	8,2	3,80	10,0	3,09	8,0	3,24
	26 / 18	12,2	2,02	9,4	6,02	12,0	2,14	9,2	5,61	11,7	2,30	9,0	5,09	11,3	2,51	8,9	4,51	10,9	2,78	8,7	3,92	10,4	3,09	8,5	3,35
	27 / 19	12,6	2,02	9,4	6,25	12,4	2,13	9,2	5,80	12,1	2,30	9,0	5,25	11,7	2,52	8,8	4,65	11,3	2,78	8,7	4,05	10,7	3,10	8,5	3,46
	28 / 20	13,0	2,01	9,4	6,49	12,8	2,13	9,2	6,01	12,5	2,30	9,0	5,43	12,1	2,52	8,8	4,80	11,6	2,78	8,7	4,18	11,1	3,10	8,5	3,58
	30 / 22	13,9	1,99	9,5	7,00	13,6	2,12	9,3	6,45	13,3	2,29	9,1	5,81	12,9	2,51	8,9	5,13	12,4	2,79	8,7	4,46	11,9	3,11	8,5	3,82
	32 / 24	14,8	1,97	9,8	7,54	14,5	2,10	9,5	6,93	14,2	2,28	9,3	6,22	13,7	2,51	9,1	5,48	13,2	2,78	8,9	4,75	12,7	3,11	8,7	4,07
51	24 / 17	15,7	2,40	11,6	6,54	15,2	2,71	11,4	5,60	14,6	3,07	11,1	4,76	14,0	3,48	10,8	4,02	13,3	3,93	10,5	3,38	12,6	4,44	10,3	2,83
	26 / 18	16,2	2,40	12,3	6,74	15,7	2,72	12,1	5,77	15,1	3,08	11,8	4,90	14,4	3,48	11,5	4,14	13,7	3,93	11,3	3,49	13,0	4,43	11,0	2,92
	27 / 19	16,7	2,40	12,3	6,95	16,2	2,72	12,1	5,94	15,5	3,08	11,8	5,04	14,9	3,49	11,5	4,27	14,2	3,94	11,2	3,60	13,4	4,43	11,0	3,02
	28 / 20	17,2	2,41	12,3	7,16	16,7	2,73	12,0	6,11	16,0	3,09	11,7	5,19	15,4	3,49	11,5	4,39	14,6	3,94	11,2	3,71	13,8	4,42	10,9	3,12
	30 / 22	18,3	2,41	12,0	7,60	17,7	2,74	11,7	6,46	17,1	3,11	11,5	5,49	16,3	3,51	11,2	4,65	15,5	3,94	10,9	3,94	14,7	4,41	10,6	3,32
	32 / 24	19,5	2,42	11,4	8,05	18,8	2,76	11,1	6,83	18,1	3,12	10,8	5,80	17,3	3,52	10,5	4,92	16,5	3,95	10,2	4,18	15,6	4,40	9,9	3,53
61	24 / 17	17,0	2,88	12,5	5,92	16,5	3,20	12,2	5,17	15,9	3,58	11,9	4,44	15,2	4,04	11,5	3,76	14,4	4,57	11,2	3,15	13,5	5,16	10,9	2,62
	26 / 18	17,6	2,89	13,1	6,07	17,0	3,21	12,8	5,30	16,4	3,60	12,5	4,56	15,7	4,06	12,2	3,87	14,9	4,58	11,8	3,25	13,9	5,17	11,5	2,70
	27 / 19	18,1	2,91	13,1	6,23	17,6	3,23	12,8	5,45	17,0	3,62	12,4	4,69	16,2	4,07	12,1	3,99	15,4	4,59	11,8	3,35	14,4	5,18	11,5	2,78
	28 / 20	18,7	2,92	13,1	6,40	18,2	3,24	12,8	5,60	17,5	3,63	12,4	4,83	16,8	4,08	12,1	4,11	15,9	4,60	11,8	3,45	14,9	5,18	11,4	2,87
	30 / 22	19,9	2,95	13,2	6,76	19,4	3,26	12,9	5,94	18,7	3,64	12,5	5,13	17,8	4,09	12,2	4,37	16,9	4,59	11,8	3,68	15,8	5,17	11,4	3,06
	32 / 24	21,3	2,97	13,6	7,17	20,6	3,28	13,2	6,30	19,9	3,65	12,8	5,45	19,0	4,08	12,4	4,65	18,0	4,58	12,0	3,92	16,8	5,13	11,7	3,27
71	24 / 17	19,0	3,26	13,8	5,82	18,7	3,46	13,5	5,40	18,2	3,78	13,2	4,80	17,5	4,24	12,9	4,12	16,6	4,82	12,6	3,44	15,5	5,54	12,3	2,80
	26 / 18	19,6	3,27	14,4	5,99	19,3	3,47	14,1	5,55	18,7	3,80	13,8	4,93	18,0	4,26	13,5	4,23	17,1	4,84	13,2	3,53	16,0	5,55	12,9	2,88
	27 / 19	20,2	3,29	14,3	6,16	19,9	3,49	14,0	5,70	19,3	3,82	13,7	5,07	18,6	4,27	13,4	4,35	17,6	4,86	13,1	3,63	16,5	5,57	12,8	2,96
	28 / 20	20,9	3,30	14,3	6,34	20,5	3,50	14,0	5,87	20,0	3,83	13,7	5,21	19,2	4,29	13,4	4,47	18,2	4,87	13,1	3,73	17,0	5,58	12,8	3,04
	30 / 22	22,3	3,33	14,7	6,71	21,9	3,53	14,4	6,21	21,3	3,87	14,1	5,52	20,5	4,32	13,8	4,74	19,4	4,90	13,5	3,96	18,1	5,61	13,3	3,22
	32 / 24	23,8	3,36	16,0	7,09	23,4	3,57	15,7	6,57	22,8	3,90	15,4	5,84	21,9	4,36	15,2	5,02	20,7	4,93	14,9	4,20	19,2	5,63	14,6	3,42
81	24 / 17	23,8	4,16	17,1	5,72	23,4	4,44	16,8	5,26	22,7	4,89	16,4	4,63	21,7	5,50	16,0	3,94	20,5	6,28	15,7	3,26	19,0	7,22	15,3	2,63
	26 / 18	24,6	4,18	18,0	5,89	24,1	4,46	17,7	5,40	23,3	4,91	17,3	4,75	22,3	5,52	16,9	4,05	21,1	6,29	16,6	3,35	19,6	7,23	16,2	2,71
	27 / 19	25,4	4,20	18,0	6,06	24,9	4,48	17,7	5,54	24,1	4,93	17,3	4,88	23,0	5,54	16,9	4,16	21,8	6,30	16,6	3,45	20,3	7,23	16,2	2,80
	28 / 20	26,3	4,22	18,0	6,23	25,7	4,51	17,7	5,69	24,8	4,95	17,3	5,01	23,7	5,56	16,9	4,27	22,4	6,32	16,6	3,55	20,9	7,23	16,2	2,89
	30 / 22	27,9	4,26	18,1	6,56	27,3	4,55	17,7	5,99	26,4	5,00	17,2	5,28	25,3	5,60	16,8	4,51	23,9	6,35	16,4	3,76	22,2	7,24	16,0	3,06
	32 / 24	29,6	4,30	18,2	6,89	29,0	4,60	17,6	6,31	28,1	5,05	17,1	5,57	26,9	5,64	16,6	4,77	25,4	6,38	16,1	3,97	23,5	7,26	15,5	3,23
82	24 / 17	33,4	4,99	25,0	6,69	32,2	5,61	24,4	5,74	31,0	6,33	23,9	4,90	29,6	7,13	23,3	4,15	28,2	8,03	22,7	3,51	26,8	9,02	22,2	2,97
	26 / 18	34,5	5,01	26,3	6,89	33,3	5,63	25,8	5,91	32,0	6,35	25,2	5,04	30,6	7,15	24,6	4,28	29,2	8,04	24,1	3,63	27,6	9,03	23,5	3,06
	27 / 19	35,5	5,03	26,1	7,06	34,3	5,65	25,5	6,07	33,0	6,37	25,0	5,18	31,6	7,17	24,5	4,41	30,1	8,06	23,9	3,73	28,5	9,03	23,4	3,16
	28 / 20	36,6	5,05	25,7	7,25	35,4	5,67	25,2	6,24	34,1	6,39	24,7	5,34	32,7	7,18	24,2	4,55	31,1	8,07	23,7	3,85	29,4	9,03	23,2	3,26
	30 / 22	38,9	5,08	24,8	7,66	37,7	5,71	24,4	6,60	36,3	6,42	24,0	5,65	34,8	7,21	23,5	4,83	33,1	8,08	23,1	4,10	31,3	9,02	22,7	3,47
	32 / 24	41,4	5,11	23,5	8,10	40,1	5,75	23,2	6,97	38,6	6,45	22,8	5,98	37,0	7,23	22,5	5,12	35,3	8,08	22,2	4,37	33,3	8,99	21,8	3,70

Performance refers to operation at full re-circulation
 Ta = entering handling coil air temperature (°C)
 DB = dry bulb
 WB = wet bulb

kWf = Cooling capacity in kW
 kWe = Compressor power input in kW
 kWs = sensible cooling capacity (kW)

EER referred only to compressors

Performance values do not include the effect of fan motor heat

SIZES	Ta (°C) DB/WB	LEAVING EXCHANGER WATER TEMPERATURE (°C) - TEMPERATURE DIFFERENTIAL 5°C																							
		25				30				35				40				45				50			
		kWf	kWe	kWs	EER	kWf	kWe	kWs	EER	kWf	kWe	kWs	EER	kWf	kWe	kWs	EER	kWf	kWe	kWs	EER	kWf	kWe	kWs	EER
102	24 / 17	37,9	5,79	28,4	6,55	36,7	6,52	27,6	5,63	35,4	7,34	26,8	4,82	33,9	8,27	26,0	4,10	32,3	9,29	25,2	3,48	30,5	10,40	24,4	2,93
	26 / 18	39,1	5,82	30,1	6,72	37,9	6,55	29,3	5,79	36,6	7,37	28,5	4,97	35,1	8,29	27,7	4,23	33,4	9,31	27,0	3,59	31,5	10,40	26,2	3,03
	27 / 19	40,3	5,85	30,0	6,89	39,2	6,58	29,3	5,96	37,8	7,40	28,5	5,11	36,2	8,31	27,8	4,36	34,5	9,33	27,1	3,70	32,5	10,40	26,3	3,13
	28 / 20	41,6	5,88	29,8	7,07	40,4	6,61	29,2	6,11	39,0	7,43	28,5	5,25	37,4	8,34	27,8	4,48	35,6	9,35	27,2	3,81	33,6	10,50	26,5	3,20
	30 / 22	44,3	5,95	29,0	7,45	42,9	6,69	28,5	6,41	41,3	7,52	28,1	5,49	39,6	8,42	27,6	4,70	37,8	9,41	27,1	4,02	35,9	10,50	26,6	3,42
	32 / 24	47,2	6,02	27,5	7,84	45,4	6,79	27,3	6,69	43,6	7,62	27,1	5,72	41,8	8,52	26,9	4,91	40,1	9,49	26,7	4,23	38,3	10,50	26,5	3,65
122	24 / 17	46,6	7,20	35,5	6,47	45,4	8,06	34,7	5,63	43,9	9,03	34,0	4,86	42,1	10,10	33,2	4,17	39,9	11,30	32,4	3,53	37,5	12,50	31,6	3,00
	26 / 18	48,1	7,25	37,8	6,63	46,7	8,10	37,0	5,77	45,0	9,06	36,2	4,97	43,2	10,10	35,3	4,28	41,1	11,30	34,5	3,64	38,8	12,60	33,7	3,08
	27 / 19	49,5	7,30	37,9	6,78	48,0	8,14	37,0	5,90	46,3	9,09	36,1	5,09	44,4	10,20	35,2	4,35	42,3	11,30	34,3	3,74	40,0	12,60	33,4	3,17
	28 / 20	51,1	7,36	38,0	6,94	49,4	8,19	37,0	6,03	47,6	9,13	36,0	5,21	45,7	10,20	35,0	4,48	43,6	11,40	34,0	3,82	41,3	12,60	33,1	3,28
	30 / 22	54,4	7,49	38,1	7,26	52,6	8,31	36,9	6,33	50,6	9,24	35,6	5,48	48,6	10,30	34,4	4,72	46,4	11,50	33,1	4,03	44,0	12,70	31,9	3,46
	32 / 24	57,9	7,62	38,2	7,60	56,1	8,44	36,6	6,65	54,1	9,38	35,0	5,77	51,9	10,40	33,4	4,99	49,4	11,60	31,8	4,26	46,8	12,90	30,2	3,63
162	24 / 17	54,5	8,04	40,5	6,78	52,6	8,98	39,7	5,86	50,6	10,00	38,9	5,06	48,5	11,20	38,1	4,33	46,3	12,50	37,3	3,70	43,9	13,90	36,4	3,16
	26 / 18	56,1	8,09	42,8	6,93	54,3	9,02	42,0	6,02	52,4	10,10	41,2	5,19	50,2	11,20	40,4	4,48	47,9	12,50	39,5	3,83	45,4	14,00	38,7	3,24
	27 / 19	57,8	8,14	42,7	7,10	56,0	9,06	41,9	6,18	54,1	10,10	41,1	5,36	51,9	11,30	40,3	4,59	49,5	12,60	39,4	3,93	46,9	14,00	38,6	3,35
	28 / 20	59,5	8,18	42,7	7,27	57,8	9,11	41,9	6,34	55,8	10,20	41,0	5,47	53,6	11,30	40,2	4,74	51,1	12,60	39,4	4,06	48,4	14,00	38,5	3,46
	30 / 22	63,3	8,29	42,9	7,64	61,4	9,21	42,0	6,67	59,3	10,30	41,1	5,76	56,9	11,40	40,2	4,99	54,3	12,70	39,3	4,28	51,4	14,10	38,5	3,65
	32 / 24	67,5	8,39	43,4	8,05	65,3	9,31	42,5	7,01	62,9	10,40	41,5	6,05	60,2	11,50	40,5	5,23	57,4	12,80	39,6	4,48	54,3	14,30	38,6	3,80
182	24 / 17	63,5	9,76	47,2	6,51	61,5	10,80	46,2	5,69	59,3	12,00	45,2	4,94	56,8	13,40	44,3	4,24	54,0	15,00	43,3	3,60	51,0	16,70	42,3	3,05
	26 / 18	65,4	9,83	49,7	6,65	63,5	10,90	48,8	5,83	61,2	12,10	47,8	5,06	58,7	13,50	46,9	4,35	55,8	15,00	45,9	3,72	52,6	16,70	45,0	3,15
	27 / 19	67,4	9,89	49,4	6,81	65,5	10,90	48,5	6,01	63,2	12,10	47,6	5,22	60,6	13,50	46,7	4,49	57,6	15,00	45,7	3,84	54,3	16,70	44,8	3,25
	28 / 20	69,4	9,95	48,8	6,97	67,5	11,00	47,9	6,14	65,2	12,20	47,1	5,34	62,6	13,50	46,2	4,64	59,5	15,10	45,4	3,94	56,0	16,80	44,5	3,33
	30 / 22	73,7	10,10	46,5	7,30	71,8	11,10	45,8	6,47	69,5	12,30	45,1	5,65	66,6	13,60	44,4	4,90	63,3	15,10	43,7	4,19	59,6	16,80	43,0	3,55
	32 / 24	78,4	10,20	42,6	7,69	76,4	11,20	42,1	6,82	73,9	12,40	41,6	5,96	70,9	13,70	41,1	5,18	67,3	15,20	40,6	4,43	63,3	16,80	40,1	3,77
222	24 / 17	73,2	11,70	53,7	6,26	70,6	12,90	52,6	5,47	68,0	14,40	51,6	4,72	65,3	16,00	50,5	4,08	62,5	17,90	49,4	3,49	59,7	20,00	48,4	2,99
	26 / 18	75,6	11,80	56,5	6,41	73,0	13,00	55,4	5,62	70,2	14,40	54,3	4,88	67,4	16,10	53,2	4,19	64,5	18,00	52,2	3,58	61,5	20,10	51,1	3,06
	27 / 19	78,0	11,90	56,4	6,55	75,3	13,10	55,3	5,75	72,5	14,50	54,1	5,00	69,6	16,20	53,0	4,30	66,5	18,00	51,9	3,69	63,3	20,10	50,7	3,15
	28 / 20	80,4	12,00	56,3	6,70	77,7	13,20	55,1	5,89	74,9	14,60	53,9	5,13	71,8	16,20	52,7	4,43	68,6	18,10	51,5	3,79	65,2	20,20	50,3	3,23
	30 / 22	85,2	12,20	56,1	6,98	82,6	13,30	54,7	6,21	79,7	14,70	53,4	5,42	76,5	16,30	52,0	4,69	73,0	18,20	50,6	4,01	69,3	20,20	49,3	3,43
	32 / 24	89,9	12,40	56,0	7,25	87,5	13,50	54,4	6,48	84,6	14,90	52,8	5,68	81,4	16,40	51,2	4,96	77,7	18,20	49,6	4,27	73,7	20,20	47,9	3,65

Performance refers to operation at full re-circulation

Ta = entering handling coil air temperature (°C)

DB = dry bulb

WB = wet bulb

kWf = Cooling capacity in kW

kWe = Compressor power input in kW

kWs = sensible cooling capacity (kW)

EER referred only to compressors

Performance values do not include the effect of fan motor heat

High air flow

Size		31	41	51	61	71	81	82	102	122	162	182	222
Airflow	l/s	647	883	1011	1200	1250	1278	2222	2444	3194	3667	4167	4444
Airflow	m ³ /h	2330	3180	3640	4320	4500	4600	8000	8800	11500	13200	15000	16000
Max external static pressure	Pa	630	370	50	215	145	90	340	190	115	450	400	330

SIZES	Ta (°C) DB/WB	LEAVING EXCHANGER WATER TEMPERATURE (°C) - TEMPERATURE DIFFERENTIAL 5°C																							
		25				30				35				40				45				50			
		kWf	kWe	kWs	EER	kWf	kWe	kWs	EER	kWf	kWe	kWs	EER	kWf	kWe	kWs	EER	kWf	kWe	kWs	EER	kWf	kWe	kWs	EER
31	18 / 13	9,2	1,76	7,5	5,25	9,2	1,83	7,4	5,00	9,0	1,95	7,2	4,62	8,8	2,11	7,1	4,14	8,4	2,32	7,0	3,62	8,0	2,58	6,9	3,10
	20 / 14	9,6	1,76	7,9	5,44	9,5	1,83	7,8	5,17	9,3	1,95	7,6	4,77	9,0	2,12	7,5	4,27	8,7	2,33	7,4	3,74	8,3	2,58	7,3	3,20
	24 / 17	10,6	1,75	8,4	6,05	10,5	1,84	8,3	5,70	10,3	1,96	8,1	5,22	10,0	2,13	8,0	4,67	9,6	2,35	7,8	4,08	9,1	2,60	7,7	3,51
	26 / 18	11,0	1,75	8,9	6,26	10,8	1,84	8,8	5,88	10,6	1,97	8,7	5,38	10,3	2,14	8,5	4,80	9,9	2,35	8,4	4,20	9,4	2,60	8,3	3,61
	27 / 19	11,3	1,75	8,9	6,48	11,2	1,84	8,8	6,06	10,9	1,97	8,7	5,53	10,6	2,15	8,5	4,94	10,2	2,36	8,4	4,32	9,7	2,61	8,2	3,72
	28 / 20	11,7	1,75	8,9	6,70	11,5	1,85	8,8	6,25	11,3	1,98	8,6	5,69	10,9	2,15	8,5	5,08	10,5	2,37	8,3	4,44	10,0	2,62	8,2	3,83
41	18 / 13	10,8	2,04	8,5	5,31	10,7	2,14	8,4	4,99	10,4	2,29	8,3	4,54	10,1	2,50	8,3	4,02	9,6	2,76	8,2	3,48	9,1	3,09	8,1	2,94
	20 / 14	11,2	2,04	9,2	5,50	11,0	2,14	9,1	5,15	10,7	2,29	9,0	4,69	10,4	2,50	8,9	4,15	9,9	2,77	8,8	3,59	9,4	3,09	8,7	3,05
	24 / 17	12,4	2,02	9,8	6,12	12,1	2,13	9,7	5,69	11,8	2,30	9,6	5,15	11,5	2,51	9,5	4,56	11,0	2,78	9,4	3,96	10,4	3,09	9,3	3,38
	26 / 18	12,8	2,01	10,4	6,35	12,5	2,13	10,3	5,89	12,2	2,30	10,2	5,32	11,8	2,51	10,1	4,70	11,4	2,78	10,0	4,08	10,8	3,10	9,9	3,49
	27 / 19	13,2	2,01	10,4	6,59	13,0	2,13	10,3	6,09	12,6	2,30	10,2	5,49	12,2	2,52	10,1	4,85	11,7	2,78	10,0	4,21	11,2	3,10	10,0	3,60
	28 / 20	13,6	2,00	10,4	6,84	13,4	2,12	10,3	6,30	13,0	2,29	10,2	5,68	12,6	2,52	10,2	5,01	12,1	2,79	10,1	4,35	11,5	3,10	10,0	3,72
51	18 / 13	14,6	2,39	11,2	6,09	14,1	2,69	10,9	5,22	13,5	3,05	10,6	4,42	12,9	3,47	10,4	3,72	12,2	3,94	10,1	3,10	11,5	4,47	9,8	2,57
	20 / 14	15,0	2,39	12,1	6,27	14,5	2,70	11,8	5,37	13,9	3,06	11,6	4,55	13,3	3,47	11,3	3,83	12,6	3,94	11,0	3,20	11,9	4,46	10,7	2,67
	24 / 17	16,5	2,40	12,9	6,86	15,9	2,72	12,6	5,85	15,3	3,08	12,3	4,96	14,6	3,48	12,0	4,19	13,9	3,93	11,7	3,53	13,1	4,43	11,4	2,95
	26 / 18	17,0	2,41	13,7	7,06	16,4	2,72	13,4	6,02	15,8	3,09	13,1	5,11	15,1	3,49	12,8	4,32	14,3	3,93	12,5	3,64	13,5	4,42	12,2	3,05
	27 / 19	17,5	2,41	13,6	7,27	16,9	2,73	13,3	6,19	16,2	3,09	13,0	5,25	15,5	3,49	12,7	4,44	14,7	3,94	12,4	3,75	13,9	4,42	12,1	3,15
	28 / 20	18,1	2,41	13,6	7,49	17,4	2,74	13,3	6,37	16,8	3,10	13,0	5,40	16,0	3,50	12,7	4,57	15,2	3,94	12,4	3,86	14,3	4,41	12,1	3,25
61	18 / 13	15,8	2,84	12,1	5,56	15,3	3,15	11,8	4,84	14,7	3,54	11,5	4,14	14,0	3,99	11,2	3,50	13,2	4,51	10,9	2,93	12,4	5,10	10,6	2,44
	20 / 14	16,3	2,85	13,0	5,73	15,8	3,17	12,7	4,97	15,1	3,56	12,4	4,25	14,4	4,01	12,1	3,59	13,6	4,53	11,8	3,01	12,8	5,12	11,5	2,50
	24 / 17	18,0	2,90	13,8	6,21	17,4	3,22	13,5	5,40	16,7	3,61	13,3	4,62	15,9	4,06	13,0	3,90	15,0	4,58	12,7	3,27	14,0	5,17	12,4	2,71
	26 / 18	18,6	2,92	14,7	6,38	17,9	3,24	14,4	5,55	17,2	3,62	14,1	4,75	16,4	4,07	13,8	4,02	15,5	4,59	13,5	3,37	14,5	5,18	13,2	2,80
	27 / 19	19,2	2,93	14,6	6,55	18,5	3,25	14,3	5,70	17,8	3,63	14,0	4,89	16,9	4,08	13,7	4,15	16,0	4,60	13,4	3,48	14,9	5,18	13,1	2,88
	28 / 20	19,8	2,94	14,5	6,71	19,1	3,26	14,2	5,86	18,4	3,64	13,9	5,04	17,5	4,09	13,6	4,28	16,5	4,60	13,2	3,59	15,4	5,17	12,9	2,98
71	18 / 13	19,2	3,27	14,0	5,88	18,9	3,46	13,8	5,44	18,3	3,79	13,5	4,83	17,6	4,24	13,3	4,14	16,6	4,83	13,1	3,44	15,5	5,55	12,8	2,80
	20 / 14	19,8	3,28	14,9	6,04	19,5	3,48	14,6	5,60	18,9	3,80	14,3	4,98	18,2	4,26	14,0	4,27	17,2	4,84	13,8	3,55	16,0	5,56	13,5	2,88
	24 / 17	20,4	3,30	15,8	6,20	20,1	3,49	15,5	5,76	19,6	3,82	15,1	5,12	18,8	4,27	14,8	4,39	17,8	4,86	14,5	3,66	16,6	5,57	14,2	2,97
	26 / 18	21,1	3,31	15,9	6,37	20,8	3,51	15,5	5,92	20,2	3,84	15,2	5,27	19,4	4,29	14,8	4,52	18,4	4,88	14,4	3,77	17,1	5,59	14,1	3,06
	27 / 19	21,8	3,32	16,1	6,56	21,4	3,52	15,7	6,08	20,8	3,85	15,2	5,41	20,0	4,31	14,8	4,65	19,0	4,89	14,4	3,88	17,6	5,60	13,9	3,15
	28 / 20	23,2	3,34	16,7	6,94	22,8	3,56	16,1	6,41	22,2	3,89	15,5	5,69	21,3	4,35	15,0	4,89	20,1	4,93	14,4	4,09	18,8	5,63	13,8	3,33
81	18 / 13	21,7	4,11	9,9	5,29	21,3	4,38	9,0	4,87	20,7	4,83	8,1	4,28	19,8	5,45	7,2	3,62	18,6	6,26	6,3	2,97	17,1	7,24	5,4	2,36
	20 / 14	22,4	4,12	16,0	5,44	22,1	4,39	15,3	5,02	21,4	4,85	14,5	4,42	20,4	5,48	13,8	3,73	19,1	6,29	13,1	3,04	17,5	7,27	12,3	2,40
	24 / 17	24,6	4,17	18,4	5,90	24,3	4,45	18,0	5,46	23,6	4,91	17,6	4,80	22,5	5,54	17,2	4,06	21,0	6,35	16,8	3,30	19,1	7,34	16,4	2,60
	26 / 18	25,4	4,19	18,4	6,06	25,1	4,47	18,0	5,60	24,3	4,93	17,7	4,93	23,2	5,56	17,3	4,17	21,7	6,37	17,0	3,41	19,8	7,35	16,7	2,70
	27 / 19	26,2	4,22	17,7	6,23	25,8	4,50	17,4	5,74	25,1	4,95	17,1	5,06	24,0	5,58	16,7	4,29	22,5	6,38	16,4	3,52	20,7	7,36	16,1	2,81
	28 / 20	27,1	4,24	17,8	6,40	26,6	4,52	17,5	5,88	25,8	4,98	17,2	5,19	24,7	5,60	16,8	4,41	23,3	6,39	16,5	3,65	21,6	7,35	16,2	2,94
82	18 / 13	31,4	4,95	25,3	6,34	30,2	5,57	24,8	5,42	28,9	6,29	24,2	4,59	27,6	7,09	23,6	3,89	26,2	7,99	23,0	3,28	24,8	8,98	22,4	2,76
	20 / 14	32,4	4,97	27,2	6,52	31,2	5,60	26,6	5,57	29,9	6,31	26,0	4,74	28,5	7,11	25,4	4,01	27,1	8,01	24,9	3,38	25,6	8,99	24,3	2,85
	24 / 17	35,7	5,03	29,4	7,10	34,3	5,66	28,8	6,06	32,9	6,37	28,2	5,16	31,4	7,17	27,7	4,38	29,8	8,05	27,1	3,70	28,2	9,02	26,5	3,13
	26 / 18	36,8	5,04	31,4	7,30	35,4	5,68	30,8	6,23	33,9	6,39	30,2	5,31	32,4	7,18	29,6	4,51	30,8	8,06	29,1	3,82	29,1	9,02	28,5	3,23
	27 / 19	38,0	5,06	31,0	7,51	36,5	5,69	30,5	6,41	35,0	6,41	29,9	5,46	33,4	7,20	29,3	4,64	31,8	8,07	28,7	3,94	30,1	9,02	28,1	3,34
	28 / 20	39,2	5,07	30,4	7,73	37,7	5,71	29,8	6,60	36,1	6,43	29,2	5,61	34,5	7,21	28,6	4,79	32,8	8,08	28,0	4,06	31,0	9,02	27,4	3,44

Performance refers to operation at full re-circulation

Ta = entering handling coil air temperature (°C)

DB = dry bulb

WB = wet bulb

kWf = Cooling capacity in kW

kWe = Compressor power input in kW

kWs = sensible cooling capacity (kW)

EER referred only to compressors

Performance values do not include the effect of fan motor heat

SIZES	Ta (°C) DB/WB	LEAVING EXCHANGER WATER TEMPERATURE (°C) - TEMPERATURE DIFFERENTIAL 5°C																							
		25				30				35				40				45				50			
		kWf	kWe	kWs	EER	kWf	kWe	kWs	EER	kWf	kWe	kWs	EER	kWf	kWe	kWs	EER	kWf	kWe	kWs	EER	kWf	kWe	kWs	EER
102	18 / 13	35,7	5,74	28,3	6,22	34,3	6,47	27,7	5,30	32,8	7,30	27,0	4,49	31,3	8,23	26,3	3,80	29,8	9,25	25,6	3,22	28,2	10,40	25,0	2,71
	20 / 14	36,8	5,76	30,5	6,39	35,4	6,50	29,8	5,45	33,9	7,33	29,1	4,62	32,4	8,25	28,5	3,93	30,8	9,26	27,8	3,33	29,1	10,40	27,1	2,80
	24 / 17	40,4	5,84	32,1	6,92	38,9	6,58	31,5	5,91	37,3	7,41	30,8	5,03	35,7	8,32	30,1	4,29	34,0	9,32	29,4	3,65	32,2	10,40	28,8	3,10
	26 / 18	41,7	5,87	34,1	7,10	40,2	6,61	33,4	6,08	38,5	7,44	32,8	5,17	36,9	8,35	32,1	4,42	35,1	9,34	31,4	3,76	33,2	10,40	30,7	3,19
	27 / 19	43,0	5,90	34,1	7,29	41,4	6,65	33,4	6,23	39,8	7,47	32,8	5,33	38,0	8,38	32,1	4,53	36,2	9,36	31,5	3,87	34,3	10,40	30,8	3,30
	28 / 20	44,3	5,94	34,3	7,46	42,7	6,68	33,6	6,39	41,1	7,51	33,0	5,47	39,3	8,41	32,3	4,67	37,4	9,39	31,7	3,98	35,4	10,40	31,0	3,40
122	18 / 13	44,1	7,09	36,0	6,22	42,5	7,94	34,9	5,35	40,8	8,90	33,9	4,58	38,9	9,96	32,8	3,91	36,9	11,10	31,8	3,32	34,7	12,40	30,7	2,80
	20 / 14	45,5	7,14	38,8	6,37	43,9	7,98	37,8	5,50	42,2	8,93	36,8	4,73	40,3	10,00	35,8	4,03	38,2	11,20	34,9	3,41	35,9	12,50	33,9	2,87
	24 / 17	49,9	7,30	41,1	6,84	48,2	8,14	40,2	5,92	46,4	9,08	39,3	5,11	44,4	10,10	38,4	4,40	42,1	11,30	37,5	3,73	39,6	12,60	36,6	3,14
	26 / 18	51,5	7,36	43,8	7,00	49,7	8,20	42,9	6,06	47,8	9,15	42,0	5,22	45,7	10,20	41,0	4,48	43,4	11,40	40,1	3,81	40,9	12,60	39,2	3,25
	27 / 19	53,1	7,41	43,8	7,17	51,2	8,26	42,9	6,20	49,2	9,21	42,0	5,34	47,0	10,30	41,1	4,56	44,7	11,40	40,1	3,92	42,3	12,70	39,2	3,33
	28 / 20	54,8	7,47	44,0	7,34	52,7	8,33	43,1	6,33	50,6	9,29	42,2	5,45	48,3	10,30	41,2	4,69	46,0	11,50	40,3	4,00	43,7	12,70	39,4	3,44
162	18 / 13	51,4	7,99	41,3	6,43	49,5	8,92	40,4	5,55	47,5	9,97	39,5	4,76	45,4	11,20	38,5	4,05	43,1	12,50	37,6	3,45	40,6	13,90	36,7	2,92
	20 / 14	53,1	8,01	44,7	6,63	51,1	8,95	43,7	5,71	49,1	10,00	42,7	4,91	46,9	11,20	41,7	4,19	44,5	12,50	40,8	3,56	42,1	13,90	39,8	3,03
	24 / 17	58,2	8,13	46,3	7,16	56,2	9,06	45,3	6,20	54,0	10,10	44,3	5,35	51,6	11,30	43,3	4,57	49,1	12,60	42,3	3,90	46,5	14,00	41,3	3,32
	26 / 18	60,0	8,18	49,2	7,33	57,9	9,11	48,3	6,36	55,7	10,20	47,3	5,46	53,3	11,30	46,3	4,72	50,7	12,60	45,4	4,02	48,0	14,00	44,4	3,43
	27 / 19	61,8	8,24	49,9	7,50	59,7	9,16	49,0	6,52	57,4	10,20	48,2	5,63	55,0	11,40	47,3	4,82	52,3	12,60	46,4	4,15	49,5	14,10	45,5	3,51
	28 / 20	63,6	8,30	51,6	7,66	61,5	9,21	50,8	6,68	59,2	10,20	50,0	5,80	56,7	11,40	49,2	4,97	54,0	12,70	48,4	4,25	51,1	14,10	47,6	3,62
182	18 / 13	60,4	9,69	48,2	6,23	58,2	10,80	47,1	5,39	55,8	12,00	46,1	4,65	53,2	13,40	45,0	3,97	50,4	14,90	43,9	3,38	47,3	16,70	42,8	2,83
	20 / 14	62,2	9,74	51,7	6,39	60,1	10,80	50,6	5,56	57,7	12,00	49,5	4,81	55,0	13,40	48,4	4,10	52,1	15,00	47,3	3,47	48,9	16,70	46,2	2,93
	24 / 17	68,0	9,90	55,6	6,87	65,9	10,90	54,5	6,05	63,5	12,10	53,4	5,25	60,7	13,50	52,3	4,50	57,5	15,00	51,1	3,83	53,9	16,70	50,0	3,23
	26 / 18	70,0	9,95	58,9	7,04	68,0	11,00	57,8	6,18	65,5	12,20	56,7	5,37	62,6	13,50	55,6	4,64	59,3	15,10	54,5	3,93	55,6	16,70	53,4	3,33
	27 / 19	72,2	10,00	57,9	7,22	70,1	11,00	56,8	6,37	67,6	12,20	55,7	5,54	64,6	13,60	54,6	4,75	61,2	15,10	53,5	4,05	57,3	16,70	52,4	3,43
	28 / 20	74,4	10,10	56,2	7,37	72,3	11,10	55,2	6,51	69,7	12,30	54,1	5,67	66,6	13,60	53,0	4,90	63,0	15,10	52,0	4,17	59,0	16,80	50,9	3,51
222	18 / 13	68,2	11,60	53,3	5,88	65,8	12,80	51,8	5,14	63,3	14,20	50,2	4,46	60,7	15,90	48,7	3,82	57,9	17,80	47,1	3,25	55,0	19,90	45,6	2,76
	20 / 14	70,5	11,70	56,9	6,03	68,1	12,90	55,4	5,28	65,5	14,30	53,9	4,58	62,8	16,00	52,5	3,93	59,8	17,90	51,0	3,34	56,7	20,00	49,5	2,84
	24 / 17	77,3	11,90	61,3	6,50	74,9	13,00	60,0	5,76	72,2	14,40	58,7	5,01	69,1	16,10	57,4	4,29	65,8	18,00	56,0	3,66	62,1	20,10	54,7	3,09
	26 / 18	79,6	12,00	65,2	6,63	77,2	13,10	64,0	5,89	74,4	14,50	62,7	5,13	71,3	16,20	61,4	4,40	67,8	18,00	60,1	3,77	64,0	20,20	58,8	3,17
	27 / 19	81,9	12,10	64,8	6,77	79,5	13,20	63,6	6,02	76,7	14,60	62,3	5,25	73,5	16,20	61,1	4,54	69,9	18,10	59,8	3,86	66,0	20,20	58,6	3,27
	28 / 20	84,2	12,20	64,0	6,90	81,7	13,30	62,7	6,14	78,9	14,70	61,5	5,37	75,7	16,30	60,3	4,64	72,1	18,10	59,0	3,98	68,1	20,30	57,8	3,35

Performance refers to operation at full re-circulation

Ta = entering handling coil air temperature (°C)

DB = dry bulb

WB = wet bulb

kWf = Cooling capacity in kW

kWe = Compressor power input in kW

kWs = sensible cooling capacity (kW)

EER referred only to compressors

Performance values do not include the effect of fan motor heat

Supply/return electric fan performances - Standard airflow

EXTERNAL STATIC PRESSURE (Pa)			10	30	60	90	120	150	180	210	240	270	300
31	Standard airflow	m ³ /h	2050	2050	2050	2050	2050	2050	2050	2050	2050	2050	2050
	Standard airflow	l/s	569	569	569	569	569	569	569	569	569	569	569
	Fan RPM	rpm	1537	1575	1628	1679	1735	1787	1839	1894	1944	1993	2046
	Total input	kW	0,14	0,15	0,17	0,19	0,22	0,24	0,26	0,29	0,31	0,33	0,36
41	Standard airflow	m ³ /h	2800	2800	2800	2800	2800	2800	2800	2800	2800	2800	2800
	Standard airflow	l/s	778	778	778	778	778	778	778	778	778	778	778
	Fan RPM	rpm	2032	2061	2108	2150	2189	2227	2267	2305	2346	2384	2426
	Total input	kW	0,29	0,30	0,33	0,35	0,38	0,41	0,44	0,47	0,50	0,53	0,56
51	Standard airflow	m ³ /h	3200	3200	3200	3200	3200	3200	3200	3200	3200	3200	-
	Standard airflow	l/s	889	889	889	889	889	889	889	889	889	889	-
	Fan RPM	rpm	2320	2349	2388	2425	2461	2498	2534	2567	2599	2632	-
	Total input	kW	0,42	0,44	0,46	0,49	0,52	0,55	0,59	0,62	0,66	0,69	-
61	Standard airflow	m ³ /h	3800	3800	3800	3800	3800	3800	3800	3800	3800	3800	3800
	Standard airflow	l/s	1056	1056	1056	1056	1056	1056	1056	1056	1056	1056	1056
	Fan RPM	rpm	1784	1813	1847	1887	1923	1958	1995	2027	2059	2093	2125
	Total input	kW	0,41	0,43	0,46	0,49	0,52	0,55	0,60	0,63	0,67	0,72	0,76
71	Standard airflow	m ³ /h	4200	4200	4200	4200	4200	4200	4200	4200	4200	-	-
	Standard airflow	l/s	1167	1167	1167	1167	1167	1167	1167	1167	1167	-	-
	Fan RPM	rpm	1965	1987	2023	2055	2089	2124	2155	2184	2217	-	-
	Total input	kW	0,52	0,55	0,59	0,62	0,65	0,69	0,72	0,76	0,81	-	-
81	Standard airflow	m ³ /h	4500	4500	4500	4500	4500	-	-	-	-	-	-
	Standard airflow	l/s	1250	1250	1250	1250	1250	-	-	-	-	-	-
	Fan RPM	rpm	2110	2133	2165	2197	2228	-	-	-	-	-	-
	Total input	kW	0,64	0,67	0,71	0,75	0,78	-	-	-	-	-	-
82	Standard airflow	m ³ /h	7000	7000	7000	7000	7000	7000	7000	7000	7000	7000	7000
	Standard airflow	l/s	1944	1944	1944	1944	1944	1944	1944	1944	1944	1944	1944
	Fan RPM	rpm	1228	1249	1278	1304	1326	1348	1368	1389	1410	1433	1422
	Total input	kW	0,81	0,86	0,94	1,02	1,10	1,18	1,24	1,31	1,39	1,47	1,55
102	Standard airflow	m ³ /h	8000	8000	8000	8000	8000	8000	8000	8000	8000	8000	8000
	Standard airflow	l/s	2222	2222	2222	2222	2222	2222	2222	2222	2222	2222	2222
	Fan RPM	rpm	1391	1410	1438	1463	1471	1482	1502	1520	1538	1557	1576
	Total input	kW	1,17	1,22	1,31	1,41	1,49	1,57	1,67	1,76	1,83	1,91	2,00
122	Standard airflow	m ³ /h	10000	10000	10000	10000	10000	10000	10000	10000	10000	-	-
	Standard airflow	l/s	2778	2778	2778	2778	2778	2778	2778	2778	2778	-	-
	Fan RPM	rpm	1260	1281	1312	1341	1370	1399	1429	1461	1495	-	-
	Total input	kW	0,88	0,94	1,02	1,14	1,24	1,34	1,46	1,56	1,68	-	-
162	Standard airflow	m ³ /h	11500	11500	11500	11500	11500	11500	11500	11500	11500	11500	11500
	Standard airflow	l/s	3194	3194	3194	3194	3194	3194	3194	3194	3194	3194	3194
	Fan RPM	rpm	1074	1092	1118	1143	1170	1198	1228	1257	1286	1315	1344
	Total input	kW	1,14	1,24	1,36	1,46	1,60	1,74	1,88	2,04	2,18	2,36	2,54
182	Standard airflow	m ³ /h	13000	13000	13000	13000	13000	13000	13000	13000	13000	13000	13000
	Standard airflow	l/s	3611	3611	3611	3611	3611	3611	3611	3611	3611	3611	3611
	Fan RPM	rpm	1153	1174	1203	1228	1252	1273	1296	1320	1344	1370	1396
	Total input	kW	1,34	1,44	1,58	1,74	1,88	2,00	2,14	2,28	2,44	2,60	2,78
222	Standard airflow	m ³ /h	15000	15000	15000	15000	15000	15000	15000	15000	15000	15000	15000
	Standard airflow	l/s	4167	4167	4167	4167	4167	4167	4167	4167	4167	4167	4167
	Fan RPM	rpm	1317	1337	1365	1389	1411	1432	1451	1470	1489	1509	1531
	Total input	kW	2,00	2,12	2,28	2,44	2,62	2,78	2,94	3,14	3,24	5,14	5,40

The performances consider the pressure drops inside the unit (dynamic, pressure drop due to coil and filters); any pressure drop due to the accessoires (exemple: hot water coil, gas heating module and additional section of bag filters) must be subtracted from the working discharge head indicated above.

Supply/return fan performance - Reduced airflow

EXTERNAL STATIC PRESSURE (Pa)			10	30	60	90	120	150	180	210	240	270	300	330	360	390
31	Standard airflow	m ³ /h	1640	1640	1640	1640	1640	1640	1640	1640	1640	1640	1640	1640	1640	1640
	Standard airflow	l/s	456	456	456	456	456	456	456	456	456	456	456	456	456	456
	Fan RPM	rpm	1283	1325	1392	1461	1528	1588	1652	1715	1771	1830	1888	1948	1994	2048
	Total input	kW	0,09	0,10	0,12	0,14	0,16	0,18	0,20	0,22	0,24	0,26	0,28	0,31	0,33	0,35
41	Standard airflow	m ³ /h	2240	2240	2240	2240	2240	2240	2240	2240	2240	2240	2240	2240	2240	2240
	Standard airflow	l/s	622	622	622	622	622	622	622	622	622	622	622	622	622	622
	Fan RPM	rpm	1694	1727	1778	1827	1876	1922	1976	2022	2071	2120	2163	2210	2257	2304
	Total input	kW	0,18	0,19	0,22	0,24	0,27	0,29	0,32	0,34	0,37	0,39	0,42	0,45	0,48	0,50
51	Standard airflow	m ³ /h	2560	2560	2560	2560	2560	2560	2560	2560	2560	2560	2560	2560	2560	2560
	Standard airflow	l/s	711	711	711	711	711	711	711	711	711	711	711	711	711	711
	Fan RPM	rpm	1927	1960	2005	2048	2088	2131	2175	2219	2256	2303	2346	2389	2431	2469
	Total input	kW	0,26	0,27	0,30	0,32	0,35	0,38	0,41	0,43	0,46	0,49	0,52	0,55	0,58	0,61
61	Standard airflow	m ³ /h	3040	3040	3040	3040	3040	3040	3040	3040	3040	3040	3040	3040	3040	3040
	Standard airflow	l/s	844	844	844	844	844	844	844	844	844	844	844	844	844	844
	Fan RPM	rpm	1487	1519	1563	1608	1648	1690	1732	1775	1821	1863	1907	1946	1986	2027
	Total input	kW	0,27	0,28	0,31	0,34	0,37	0,41	0,44	0,47	0,51	0,54	0,58	0,62	0,65	0,69
71	Standard airflow	m ³ /h	3360	3360	3360	3360	3360	3360	3360	3360	3360	3360	3360	3360	3360	3360
	Standard airflow	l/s	933	933	933	933	933	933	933	933	933	933	933	933	933	933
	Fan RPM	rpm	1631	1673	1701	1743	1780	1816	1855	1892	1931	1972	2011	2052	2089	2125
	Total input	kW	0,34	0,36	0,38	0,41	0,44	0,48	0,52	0,55	0,59	0,63	0,66	0,71	0,75	0,79
81	Standard airflow	m ³ /h	3600	3600	3600	3600	3600	3600	3600	3600	3600	3600	3600	3600	3600	3600
	Standard airflow	l/s	1000	1000	1000	1000	1000	1000	1000	1000	1000	1000	1000	1000	1000	1000
	Fan RPM	rpm	1749	1775	1814	1853	1889	1923	1959	1993	2030	2066	2105	2144	2177	2212
	Total input	kW	0,40	0,42	0,44	0,48	0,51	0,55	0,59	0,63	0,67	0,71	0,75	0,79	0,83	0,88
82	Standard airflow	m ³ /h	5600	5600	5600	5600	5600	5600	5600	5600	5600	5600	5600	5600	5600	5600
	Standard airflow	l/s	1556	1556	1556	1556	1556	1556	1556	1556	1556	1556	1556	1556	1556	1556
	Fan RPM	rpm	996	1021	1052	1079	1104	1131	1160	1190	1220	1250	1280	1310	1340	1369
	Total input	kW	0,44	0,48	0,54	0,60	0,66	0,72	0,78	0,85	0,93	1,01	1,09	1,17	1,25	1,33
102	Standard airflow	m ³ /h	6400	6400	6400	6400	6400	6400	6400	6400	6400	6400	6400	6400	6400	6400
	Standard airflow	l/s	1778	1778	1778	1778	1778	1778	1778	1778	1778	1778	1778	1778	1778	1778
	Fan RPM	rpm	1128	1151	1181	1206	1231	1253	1276	1299	1325	1351	1378	1404	1430	1456
	Total input	kW	0,63	0,68	0,75	0,82	0,89	0,96	1,02	1,09	1,17	1,25	1,33	1,42	1,51	1,60
122	Standard airflow	m ³ /h	8000	8000	8000	8000	8000	8000	8000	8000	8000	8000	8000	8000	-	-
	Standard airflow	l/s	2222	2222	2222	2222	2222	2222	2222	2222	2222	2222	2222	2222	-	-
	Fan RPM	rpm	1024	1049	1085	1122	1160	1202	1242	1280	1317	1352	1387	1423	-	-
	Total input	kW	0,48	0,54	0,62	0,70	0,78	0,90	1,00	1,10	1,20	1,32	1,42	1,54	-	-
162	Standard airflow	m ³ /h	9200	9200	9200	9200	9200	9200	9200	9200	9200	9200	9200	9200	9200	9200
	Standard airflow	l/s	2556	2556	2556	2556	2556	2556	2556	2556	2556	2556	2556	2556	2556	2556
	Fan RPM	rpm	873	895	926	962	999	1035	1072	1107	1143	1179	1213	1245	1246	1307
	Total input	kW	0,62	0,70	0,78	0,90	1,02	1,14	1,28	1,42	1,54	1,68	1,82	1,96	2,12	2,26
182	Standard airflow	m ³ /h	10400	10400	10400	10400	10400	10400	10400	10400	10400	10400	10400	10400	10400	10400
	Standard airflow	l/s	2889	2889	2889	2889	2889	2889	2889	2889	2889	2889	2889	2889	2889	2889
	Fan RPM	rpm	936	961	992	1020	1048	1079	1112	1144	1176	1209	1240	1272	1304	1335
	Total input	kW	0,72	0,80	0,92	1,04	1,14	1,26	1,40	1,54	1,68	1,84	1,98	2,14	2,28	2,44
222	Standard airflow	m ³ /h	12000	12000	12000	12000	12000	12000	12000	12000	12000	12000	12000	12000	12000	12000
	Standard airflow	l/s	3333	3333	3333	3333	3333	3333	3333	3333	3333	3333	3333	3333	3333	3333
	Fan RPM	rpm	1070	1093	1123	1148	1172	1196	1222	1250	1278	1306	1334	1362	1390	1417
	Total input	kW	1,08	1,18	1,32	1,44	1,56	1,68	1,82	1,96	2,12	2,28	2,44	2,62	2,80	2,98

The performances consider the pressure drops inside the unit (dynamic, pressure drop due to coil and filters); any pressure drop due to the accessoires (exemple: hot water coil, gas heating module and additional section of bag filters) must be subtracted from the working discharge head indicated above.

Supply/return fan performance - High airflow

EXTERNAL STATIC PRESSURE (Pa)			10	30	60	90	120	150	180	210	240	270
31	Standard airflow	m ³ /h	2330	2330	2330	2330	2330	2330	2330	2330	2330	2330
	Standard airflow	l/s	647	647	647	647	647	647	647	647	647	647
	Fan RPM	rpm	1700	1737	1788	1835	1885	1930	1976	2023	2073	2119
	Total input	kW	0,18	0,19	0,21	0,23	0,26	0,29	0,31	0,34	0,36	0,39
41	Standard airflow	m ³ /h	3180	3180	3180	3180	3180	3180	3180	3180	3180	3180
	Standard airflow	l/s	883	883	883	883	883	883	883	883	883	883
	Fan RPM	rpm	2267	2296	2337	2375	2414	2452	2488	2523	2554	2589
	Total input	kW	0,38	0,40	0,43	0,46	0,49	0,52	0,55	0,58	0,61	0,65
51	Standard airflow	m ³ /h	3640	3640	3640	-	-	-	-	-	-	-
	Standard airflow	l/s	1011	1011	1011	-	-	-	-	-	-	-
	Fan RPM	rpm	2594	2620	2656	-	-	-	-	-	-	-
	Total input	kW	0,57	0,59	0,62	-	-	-	-	-	-	-
61	Standard airflow	m ³ /h	4320	4320	4320	4320	4320	4320	4320	4320	-	-
	Standard airflow	l/s	1200	1200	1200	1200	1200	1200	1200	1200	-	-
	Fan RPM	rpm	1996	2018	2053	2086	2117	2152	2183	2215	-	-
	Total input	kW	0,53	0,56	0,60	0,64	0,67	0,71	0,74	0,78	-	-
71	Standard airflow	m ³ /h	4500	4500	4500	4500	4500	-	-	-	-	-
	Standard airflow	l/s	1250	1250	1250	1250	1250	-	-	-	-	-
	Fan RPM	rpm	2083	2105	2138	2171	2202	-	-	-	-	-
	Total input	kW	0,60	0,63	0,68	0,72	0,75	-	-	-	-	-
81	Standard airflow	m ³ /h	4600	4600	4600	4600	-	-	-	-	-	-
	Standard airflow	l/s	1278	1278	1278	1278	-	-	-	-	-	-
	Fan RPM	rpm	2147	2169	2204	2232	-	-	-	-	-	-
	Total input	kW	0,67	0,70	0,75	0,78	-	-	-	-	-	-
82	Standard airflow	m ³ /h	8000	8000	8000	8000	8000	8000	8000	8000	8000	8000
	Standard airflow	l/s	2222	2222	2222	2222	2222	2222	2222	2222	2222	2222
	Fan RPM	rpm	1391	1410	1438	1462	1485	1505	1524	1543	1561	1579
	Total input	kW	1,17	1,23	1,32	1,40	1,40	1,59	1,68	1,77	1,84	1,92
102	Standard airflow	m ³ /h	8800	8800	8800	8800	8800	8800	8800	-	-	-
	Standard airflow	l/s	2444	2444	2444	2444	2444	2444	2444	-	-	-
	Fan RPM	rpm	1522	1540	1565	1590	1612	1632	1651	-	-	-
	Total input	kW	1,53	1,59	1,69	1,79	1,88	1,99	2,09	-	-	-
122	Standard airflow	m ³ /h	11500	11500	11500	11500	11500	11500	11500	-	-	-
	Standard airflow	l/s	3194	3194	3194	3194	3194	3194	3194	-	-	-
	Fan RPM	rpm	1388	1407	1435	1462	1488	1514	1541	-	-	-
	Total input	kW	1,18	1,26	1,38	1,48	1,60	1,70	1,82	-	-	-
162	Standard airflow	m ³ /h	13200	13200	13200	13200	13200	13200	13200	13200	13200	13200
	Standard airflow	l/s	3667	3667	3667	3667	3667	3667	3667	3667	3667	3667
	Fan RPM	rpm	1223	1239	1263	1285	1306	1329	1354	1378	1404	1429
	Total input	kW	1,66	1,78	1,92	2,06	2,18	2,32	2,48	2,64	2,80	2,98
182	Standard airflow	m ³ /h	15000	15000	15000	15000	15000	15000	15000	15000	15000	15000
	Standard airflow	l/s	4167	4167	4167	4167	4167	4167	4167	4167	4167	4167
	Fan RPM	rpm	1317	1337	1365	1389	1411	1432	1451	1470	1489	1509
	Total input	kW	1,98	2,12	2,28	2,44	2,62	2,80	2,94	3,10	3,24	3,40
222	Standard airflow	m ³ /h	16000	16000	16000	16000	16000	16000	16000	16000	16000	16000
	Standard airflow	l/s	4444	4444	4444	4444	4444	4444	4444	4444	4444	4444
	Fan RPM	rpm	1400	1419	1445	1470	1492	1511	1530	1548	1566	1584
	Total input	kW	2,40	2,52	2,70	2,86	3,06	3,24	3,42	3,58	3,74	3,90

The performances consider the pressure drops inside the unit (dynamic, pressure drop due to coil and filters); any pressure drop due to the accessoires (exemple: hot water coil, gas heating module and additional section of bag filters) must be subtracted from the working discharge head indicated above.

Pressure drops of optional components

The value of static pressure available on the supply and return duct is obtained by subtracting from the available net maximum pressure (see general table of technical data) the pressure drops of any accessories.

Size		31	41	51	61	71	81	82	102	122	162	182	222
CHW2 - Two-rows hot water coil	Pa	15	18	23	20	27	30	40	50	41	50	39	50
CPHG - Hot gas re-heating coil	Pa	—	—	—	—	—	—	18	25	18	25	18	25

Standard unit water circuit pressure drops

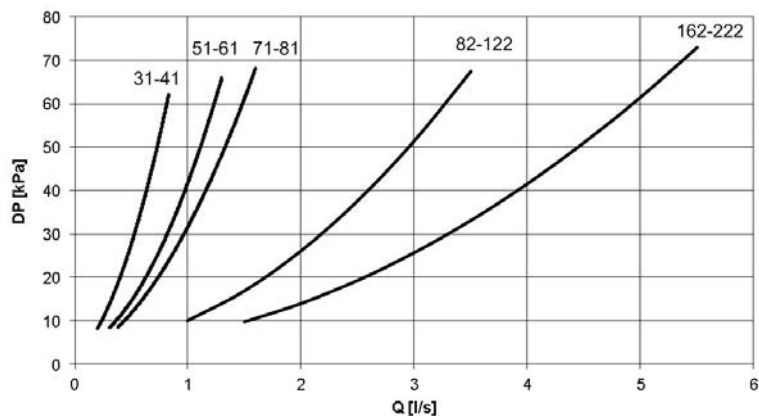

Q = water flow rate (l/s)

DP = water side pressure drops (kPa)



The standard unit includes the following components:

1. plate exchanger and water temperature control probes on inlet and outlet (to prevent ice forming and to disable the compressor when the water temperature sets down a limit value)
2. drainage valve (to allow the exchanger to be drained for maintenance)
3. vent valve (to let air out of the system)

The unit does not include additional shut-off valve or control of bleed valve (to let air out of the system)

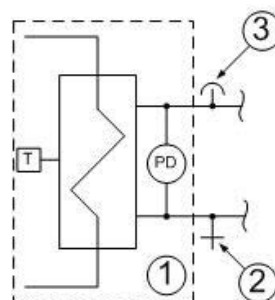

Accessories

CHW2 - Two-row hot water coil

Option recommended for very cold climates since it allows heating of the served room. The battery is equipped with a thermostat for the anti-freeze function. The anti-freeze function is always active, even when the unit is in standby. If necessary, it forces opening of the valve to the maximum allowable value for allow passage of water in the coil and to prevent the formation of ice.

Hot water coil pressure drops: AIR side

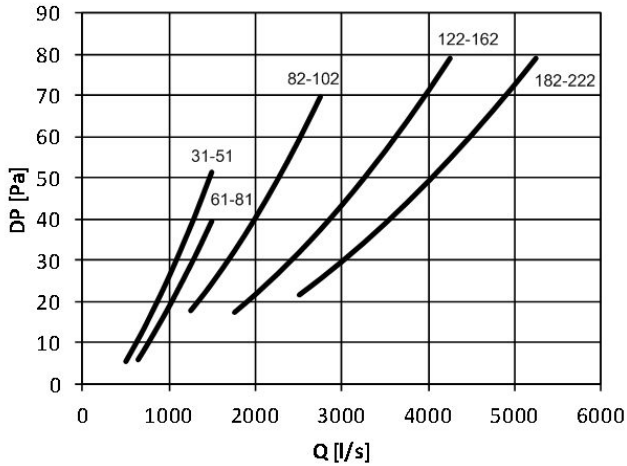

The air side pressure drops are relative to the medium air temperature of 20°C and are to be added to the pressure drops due to ducts, terminal devices and any other component that causes a drop in working discharge head.

Q [l/s] = air flow rate
DP [Pa] = pressure drops

Hot water coil pressure drops: WATER side

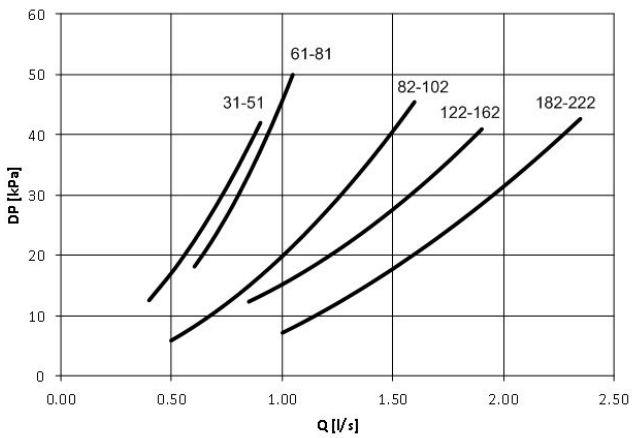

Pressure drops on the water side are calculated considering an average water temperature of 65°C

Q [l/s] = air flow rate
DP [kPa] = PRESSURE DROPS

$$Q[l/s] = kWt(4,186 \times DT)$$

Q [l/s] = air flow rate
kWt = Provided heating capacity (kW)
DT = DIFFERENCE BETWEEN INLET AND OUTLET WATER TEMPERATURE (°C)



This option reduces the available static pressure (supply air side).



The component requires connection to the hot water plumbing system (to be provided for by the client).



hot water coil and electric heaters cannot be mounted at the same time



Hot water coil, electric heater and re-heating coil cannot be fitted at the same time

Performances of hot water coil (two-row)

Size		Ti/To (°C)			
		80/65	70/55	60/40	
		kWt	kWt	kWt	
31	Qo (l/s)	569			
	Ta (°C)	5	24,8	20,8	15,2
		10	22,7	18,7	13,2
		14	21,0	17,1	11,5
		16	20,2	16,2	10,7
		18	19,4	15,4	9,9
		20	18,6	14,6	9,2
41	Qo (l/s)	778			
	Ta (°C)	5	30,5	25,4	18,5
		10	27,8	22,9	16,0
		14	25,8	20,9	14,0
		16	24,8	19,9	13,0
		18	23,8	18,9	12,1
		20	22,8	17,9	11,1
51	Qo (l/s)	889			
	Ta (°C)	5	33,1	27,7	20,1
		10	30,3	24,9	17,4
		14	28,1	22,7	15,2
		16	26,9	21,6	14,2
		18	25,8	20,6	13,1
		20	24,7	19,5	12,0
61	Qo (l/s)	1056			
	Ta (°C)	5	41,2	34,5	25,5
		10	37,7	31,1	22,1
		14	34,9	28,4	19,5
		16	33,6	27,1	18,2
		18	32,2	25,8	16,8
		20	30,9	24,4	15,5
71	Qo (l/s)	1167			
	Ta (°C)	5	43,9	36,8	27,1
		10	40,2	33,2	23,5
		14	37,3	30,3	20,7
		16	35,8	28,9	19,3
		18	34,3	27,4	17,9
		20	32,9	26,0	16,5
81	Qo (l/s)	1250			
	Ta (°C)	5	45,9	38,5	28,3
		10	42,0	34,6	24,5
		14	38,9	31,6	21,6
		16	37,4	30,1	20,1
		18	35,9	28,6	18,7
		20	34,4	27,2	17,2
82	Qo (l/s)	1944			
	Ta (°C)	5	72,8	61,1	44,9
		10	66,6	55,0	39,0
		14	61,8	50,2	34,3
		16	59,3	47,8	32,0
		18	57,0	45,5	29,6
		20	54,6	43,2	27,3
102	Qo (l/s)	2222			
	Ta (°C)	5	79,2	66,4	48,7
		10	72,5	59,7	42,3
		14	67,2	54,6	37,2
		16	64,5	52,0	34,6
		18	61,9	49,5	32,1
		20	59,3	46,9	29,6
122	Qo (l/s)	2778			
	Ta (°C)	5	103,5	86,7	63,6
		10	94,7	78,1	55,1
		14	87,7	71,3	48,5
		16	84,3	67,9	45,1
		18	80,9	64,5	41,8
		20	77,5	61,2	38,5
162	Qo (l/s)	3194			
	Ta (°C)	5	112,9	94,6	69,2
		10	103,3	85,1	60,0
		14	95,8	77,7	52,7
		16	92,0	74,1	49,1
		18	88,3	70,4	45,5
		20	84,6	66,8	41,9
182	Qo (l/s)	3611			
	Ta (°C)	5	137,2	115,4	85,8
		10	125,7	104,1	74,7
		14	116,6	95,1	66,0
		16	112,1	90,7	61,5
		18	107,6	86,3	57,2
		20	103,2	81,9	52,8
222	Qo (l/s)	4167			
	Ta (°C)	5	150,1	126,2	93,6
		10	137,5	113,8	81,5
		14	127,6	104,0	71,9
		16	122,6	99,2	67,1
		18	117,7	94,4	62,3
		20	112,9	89,5	57,5

Ta = entering handling coil air temperature (°C)
 Ti/To = inlet/outlet water temperature (°C)
 Qo = airflow (l/s)
 kWt = Provided heating capacity (kW)

3WVM - Modulating 3-way valve

To be combined with hot water coil (optional). It is managed by the built-in microprocessor via a 0-10V signal and allows the fully automatic control of the water coil.

The valve with modulating actuator is provided already assembled and wired built-in the unit.



3WVM - Modulating 3-way valve : available only from size 82 to size 222

3WVPX- Modulating 3-way valve: available from size 31 to size 81

3-way valve pressure drop

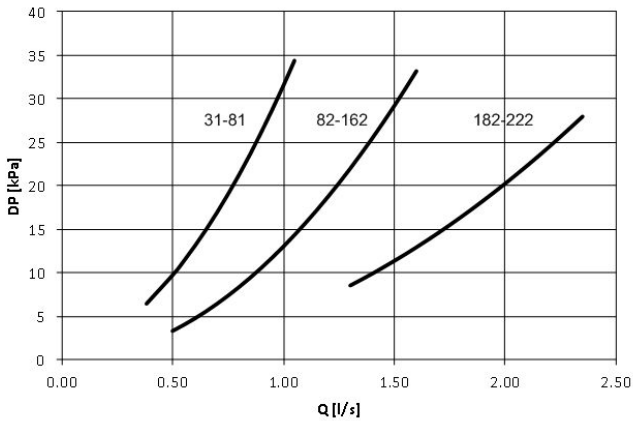

Q [l/s] = air flow rate
DP [kPa] = PRESSURE DROPS

$$Q[l/s]= kWt/(4,186 \times DT)$$

Q [l/s] = air flow rate
kWt = Provided heating capacity (kW)
DT = DIFFERENCE BETWEEN INLET AND OUTLET WATER TEMPERATURE (°C)

This accessory is for use in conjunction with option: CHW2 - 2row hot water coil

Accessory separately supplied: from size 31 to size 81

EH - Electric elements

This option is advisable for cold climates. Available in various powers, it allows heating of the served room. The electrical heating elements are managed by a thermal control device with two power settings.

Ideal for lower outside temperature applications where it is required to active the heaters only for short duration in the year. In these cases, simplification of the system is more economical than electrical conduction cost.

The fins are made of aluminium, with a size suitable to ensure high efficiency and maintain low power density on the surfaces to limit overheating. The low temperature of the heating elements increases their lifespan and limits the effect of air ionization.



Matching of the electric elements

Size	31	41	51	61	71	81	82	102	122	162	182	222
4.5 kW	√	√	√	√	√	√	X	X	X	X	X	X
6kW	√	√	√	√	√	√	X	X	X	X	X	X
9 kW	√	√	√	√	√	√	X	X	X	X	X	X
12 kW	√	√	√	√	√	√	√	√	√	√	X	X
18 kW	X	X	X	√	√	√	√	√	√	√	√	√
27 kW	X	X	X	X	X	X	√	√	√	√	√	√
36 kW	X	X	X	X	X	X	X	X	X	X	√	√

This option involves variation of the main electrical data of the unit.

hot water coil and electric heaters cannot be mounted at the same time

PSAF - Clogged filter differential pressure switch air side

It allows to detect and signal (by an appropriate warning) the reaching of the max. level of air filter clogging.

The unit handler receives an indication when to perform the necessary maintenance of the filters.

The detecting device is installed in the unit and it is already connected to the unit electrical panel and pre-calibrated in the factory. The calibration can be modified by the qualified assistance centre during the start-up.



PCOSM - Constant supply airflow

This device adjusts the speed of the fans to keep a constant flow rate, adapting to system losses and compensation for the filters as they get dirty. It is composed of a pressure sensor located in the supply section which measures the pressure, and a differential pressure switch that transforms the value into an electrical signal, based on the parameters detected the unit intervenes, adjusting the speed of the motors to re-establish the set flow rate value.



MHP - High and low pressure gauges

Allows the pressure measurement of the refrigerant to the compressor intake and supply, making the inspection of these parameters easier for the technicians involved in the management of the unit.

The two liquid pressure gauges and corresponding pressure sockets are installed built-in the unit in an easily accessible location.



CPHG - Hot gas re-heating coil

Available from size 82 to size 222.

This option is recommended during the summer when dehumidification is required. The flow of air to enter the room may contain a higher level of humidity than desired. The dehumidification process is used to reduce it. The air flow is first cooled in the treatment coil with separation of condensation. It is then freely re-heated to maintain the desired condition of comfort in the room served.

The re-heat coil is located behind the handling coil and is activated by diverting a flow of hot refrigerant gas downstream from the compressors through the action of a dedicated solenoid valve.

The process starts operating based on the humidity set-point established by the user.

With respect to traditional devices, such as electrical electric elements or hot water coils, use of the re-heat coil does not consume any extra energy. It also lowers refrigerant condensation temperature, which provides two positive effects: power absorbed by the compressors is considerably reduced, and at the same time, cooling capacity is increased, resulting in greater efficiency (EER).

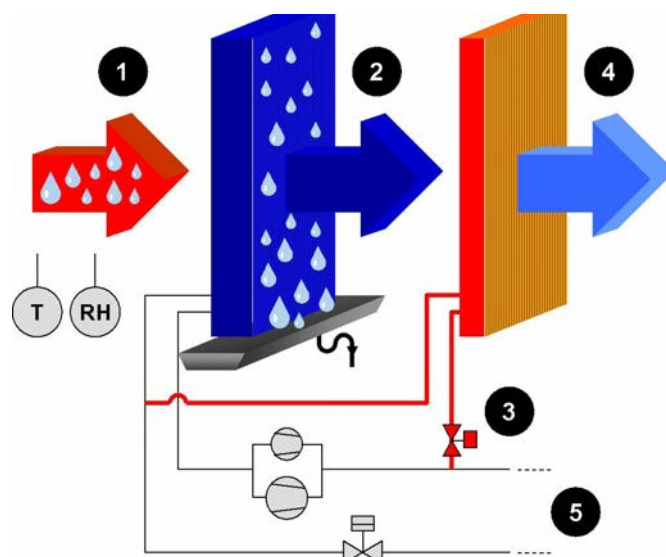

- 1 Air to be treated and temperature / humidity probe
- 2 Chilled and dehumidified air in the internal exchanger (evaporator)
- 3 Automatic hot gas pump valve
- 4 Air treated by the post-heating exchanger
- 5 External exchanger (condenser)

Indicative scheme - not in scale

This option reduces the available static pressure (supply air side).

Hot water coil and re-heating coil cannot be fitted at the same time

This accessory is to be matched with the electronic ambient control supplied as standard with the CWM or, alternatively, with the CIWM option - electronic ambient control with display for uncased wall installation or CSOND - ambient temperature and humidity control with built-in probes.

Performances of hot gas re-heating coil

Available from size 82 to size 222.

SIZES		EXTERNAL AIR TEMPERATURE (°C)						
		15	20	25	30	35	40	
		kWt	kWt	kWt	kWt	kWt	kWt	
82	Qo (l/s)	1944						
	Ta (°C)	10	9,0	11,7	14,6	17,5	20,4	23,4
		12	7,8	10,6	13,4	16,3	19,2	22,2
		14	6,7	9,5	12,3	15,1	18,0	21,0
		16	5,6	8,4	11,1	14,0	16,8	19,8
		18	4,6	7,3	10,0	12,8	15,7	18,6
		20	3,5	6,2	8,9	11,7	14,5	17,4
102	Qo (l/s)	2222						
	Ta (°C)	10	9,7	12,7	15,7	18,9	22,0	25,3
		12	8,4	11,4	14,5	17,6	20,8	24,0
		14	7,3	10,2	13,2	16,3	19,5	22,7
		16	6,1	9,0	12,0	15,1	18,2	21,4
		18	4,9	7,8	10,8	13,8	16,9	20,1
		20	3,7	6,6	9,6	12,6	15,7	18,8
122	Qo (l/s)	2778						
	Ta (°C)	10	13,0	17,0	21,1	25,2	29,4	33,7
		12	11,4	15,4	19,4	23,5	27,7	32,0
		14	9,8	13,7	17,8	21,9	26,0	30,3
		16	8,3	12,1	16,1	20,2	24,3	28,6
		18	6,7	10,6	14,5	18,5	22,7	26,9
		20	5,2	9,0	12,9	16,9	21,0	25,2
162	Qo (l/s)	3194						
	Ta (°C)	10	14,1	18,4	22,8	27,3	31,9	36,6
		12	12,3	16,6	21,0	25,5	30,1	34,7
		14	10,6	14,9	19,2	23,7	28,2	32,8
		16	8,9	13,1	17,5	21,9	26,4	31,0
		18	7,2	11,4	15,7	20,1	24,6	29,1
		20	5,6	9,7	14,0	18,3	22,8	27,3
182	Qo (l/s)	3611						
	Ta (°C)	10	17,3	22,5	27,8	33,3	38,8	44,5
		12	15,1	20,4	25,7	31,1	36,6	42,2
		14	13,1	18,2	23,5	28,9	34,4	40,0
		16	11,0	16,1	21,4	26,7	32,2	37,8
		18	9,0	14,1	19,3	24,6	30,0	35,5
		20	7,0	12,0	17,1	22,4	27,8	33,3
222	Qo (l/s)	4167						
	Ta (°C)	10	18,7	24,4	30,2	36,2	42,2	48,4
		12	16,4	22,1	27,9	33,8	39,8	45,9
		14	14,1	19,8	25,5	31,4	37,4	43,5
		16	11,9	17,5	23,2	29,0	35,0	41,0
		18	9,7	15,2	20,9	26,7	32,6	38,6
		20	7,5	13,0	18,6	24,3	30,2	36,2

Ta = outlet air temperature from the treatment coil and entering the post-heating coil

Qo = air flow rate (l/s)

kWt = thermal power provided (kW)

The post-heating coil is powered by hot gas pumped between the compressor supply and the condensing coil.

Since the temperature of the hot condensation gas is correlated to the outdoor air temperature, the indicative potential of the re-heating coil is expressed in relation to the outdoor air temperature.

CIWM - Electronic room control with display, for wall installation in built-in box

Option which allows the remote control of the unit which can be easily installed in the main built-in units which are available on the market with squared or rounded 65 mm diameter / 31 mm deep profiles.

The electronic control with display is simple to use even for non-specialised users.

Thanks to the icon menu which is complete with back-lighting, it allows different unit functions to be controlled, including:

- switching the unit on and off
- reading the temperature using the probe in its interior
- displaying of the operating stata and any alarms
- password protection to access the unit's parameters
- changing the manual operating mode (hot or cold) and/or set point
- Programming the daily and weekly time schedule for switching on and off and for setting the standard or economic set point.
- management of the operating parameters.
- language management for the navigation menu

The device is connected to the unit electrical panel by shielded twisted pair cables (section from 0.5 a 1.5 mm²), at a maximum distance of 200 m. The power supply is at 230Vac.



Installation, electrical power supply and connection to the electrical panel are encharged to the client.

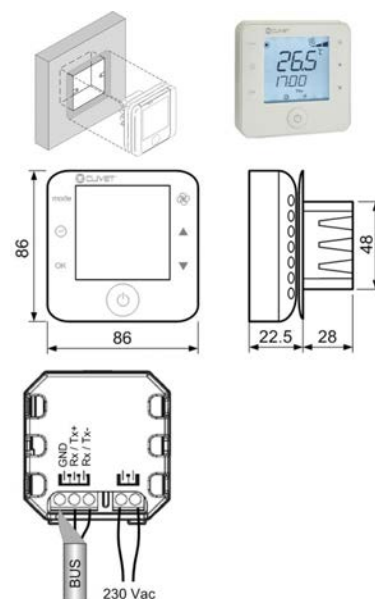

CONTE - Electronic room control with display visible on the unit

The electronic control with display is simple to use even for non-specialised users.

Thanks to the back-lit icon menù, enabling all the unit functions to be controlled, including these main functions:

- switching the unit on and off
- reading the temperature using the probe in its interior
- displaying of the operating stata and any alarms
- unit parameter protection with password
- changing the manual operating mode (hot or cold) and/or set point
- programing the daily and weekly time schedule for switching on and off and for setting the standard or economic set point.
- management of the operating parameters.
- language management for the navigation menu

The device is built-in the unit.



The device requires matching with one of the following options:
CTEM - Temperature ambient control by on board probe
CSOND - Humidity and temperature control with built-in probes



1. electronic control with display installed built-in
2. built-in probes

CTEM - Temperature control with built-in probes

This option enables the temperature of the served ambient to be read directly from the unit return airflow. Automatic thermoregulation takes place using built-in probes while those on the electronic control are inhibited.

The device is installed and wired built-in the unit.



The device requires matching with the option:
CONTE - Electronic room control with display visible on the unit

CSOND - Humidity and temperature control with built-in probes

This option makes it possible to measure the temperature and humidity ambient directly on the air flow entering the unit. The automatic thermal regulation is done using the on-board probes, whereas the probes on the remote control are inhibited.

The device is installed and wired built-in the unit.



The device requires matching with the option:
CONTE - Electronic room control with display visible on the unit

CUE - External humidifier control with 0-10V command

In applications where it is scheduled to air humidification of ambient, it is possible to receive a from unit a 0-10V or 4-20mA control signal to manage an external humidifier by the Customer. The electronics of the unit provides a control signal of 0-10V or 4-20mA type.

External humidifier installation and electrical power supply is encharged to the client.

This accessory is to be matched with the electronic ambient control supplied as standard with the CWM or, alternatively, with the CIWM option - electronic ambient control with display for uncased wall installation or CSOND - ambient temperature and humidity control with built-in probes.

PM - Phase monitor

The phase monitor makes it possible to check the correct connection of the phases and their imbalance in units powered with a tri-phase system. If the connection of the phases is not correct, or the threshold of phase imbalance is exceeded, or the voltage is too high or too low for a certain amount of time, the monitor acts on the control circuit and orders the unit to be shut down. As soon as nominal line conditions are restored, the unit is automatically reset.

PFCP - Power factor correction capacitors (cosfi > 0.9)

The component is necessary to lower the phase difference between current and voltage in the electromagnetic components of the unit (e.g. asynchronous motors).

The component allows to put the cosfi power factor to values on average higher than 0.9, reducing the network reactive power. This often leads to an economic benefit which the energy provider grants to the final user.

The device is installed and wired built-in the unit.



MOB - RS485 Serial port with Modbus protocol.

It allows the serial connection to supervision systems, using Modbus as the communication protocol. It allows the access to the complete list of operating variables, controls and alarms.

On the serial line can be connected up to 32 units for a typical distance of 1000 m. The connection is made using a suitable cable to RS485 network or formed by a twisted pair and shielded wires.

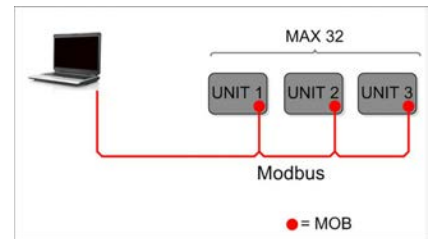

The device is installed and wired built-in the unit.

MIPC - Hydraulic pipework arrangement for loop with constant flow rate with manual valves

Option supplied built-in. It simplifies the design and the installation in closed loop applications at constant water flow-rate. Accessory complete with manual shut-off valves at the inlet and outlet to the water side exchanger, a manual 3-way valve which operates as a by-pass during water circuit cleaning, one drain bibcock.

Pressure drop of the unit complete with option MIPC

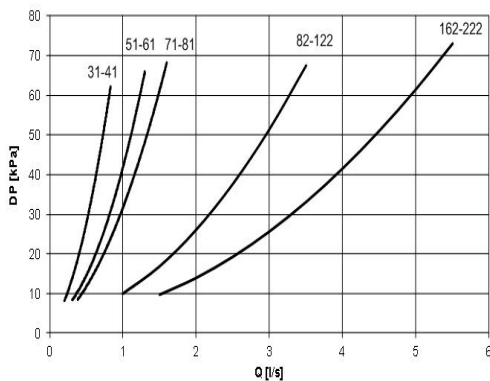

MIPC option scheme

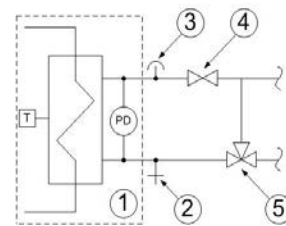

Q = water flow rate (l/s)
DP = water side pressure drops (kPa)

The water flow rate must be calculated with the following formula.

$$Q [l/s] = \frac{kWf + kWc}{4,186 \times DT}$$

Q = water flow rate (l/s)
kWf = Cooling capacity in (kW)
kWc = Compressor power input in kW
DT = Temperature difference between inlet / outlet water

1. Internal exchanger with temperature probe, pressure switch
2. Drainage bibcock
3. Vent valve
4. Hand shut-off valve
5. Manual activation three-way valve for by-pass and manual shut off

MIPV - Hydraulic pipework arrangement for loop with variable flow rate with 2 way ON-OFF valve

Option supplied built-in. It simplifies the design and the installation in closed loop applications at variant water flow-rate. Includes a 2-way motorised ON/OFF valve at the exchanger outlet of the water side, powered and controlled by the unit. Its function is coupled to that of the refrigerant circuit: with the stopped compressor, the valve stays closed, reducing water consumption. Furthermore, this option is complete with shut-off valves with manual activation at the exchanger inlet of the water side, a 3-way valve with manual activation which operates as a by-pass during the water circuit cleaning, one drain and one vent bibcocks.

Pressure drop of the unit complete with option MIPV

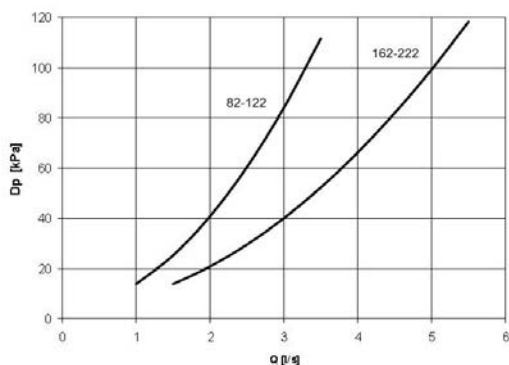

Q = water flow rate (l/s)

DP = water side pressure drops (kPa)

The water flow rate must be calculated with the following formula.

$$Q [l/s] = \frac{kWf + kWe}{4,186 \times DT}$$

Q = water flow rate (l/s)

kWf = Cooling capacity in (kW)

kWe = Compressor power input in kW

DT = Temperature difference between inlet / outlet water

MIPV option scheme

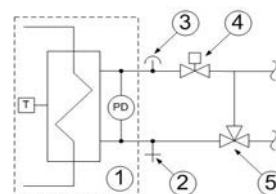

1. Internal exchanger with temperature probe, pressure switch
2. Drainage bibcock
3. Vent valve
4. Hand shut-off valve
5. Manual activation three-way valve for by-pass and manual shut off

MIPM - Plumbing assembly for loop with disposable water system with 2-way modulating valve

Option supplied built-in. It simplifies design and installation in disposable water applications with relatively low temperatures (well, water sheet, aqueduct). Includes a 2-way motorised modulating valve at the outlet of the water side exchanger, powered and controlled by the unit. Its operation, depending on to the refrigerant pressure in the heat exchanger on the source side, takes place by modulating a signal 0-10V to reduce the water consumption and to maintain the unit in the expected operation area. The option is complete with shut-off valves with manual activation at the inlet of the water side exchanger, one 3-way valve with manual activation which works as a by-pass during the water circuit cleaning, one vent and one drain bibcock.

Pressure drop of the unit complete with option MIPM

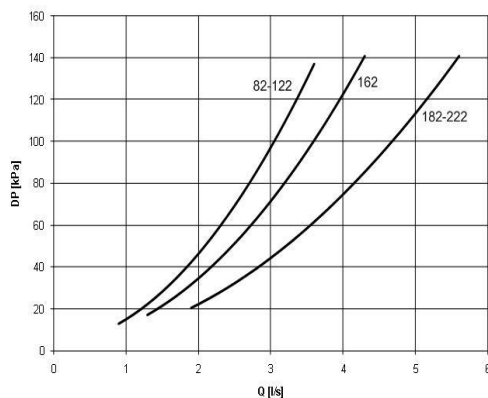

Q = water flow rate (l/s)

DP = water side pressure drops (kPa)

The water flow rate must be calculated with the following formula.

$$Q [l/s] = \frac{kWf + kWe}{4,186 \times DT}$$

Q = water flow rate (l/s)

kWf = Cooling capacity in (kW)

kWe = Compressor power input in kW

DT = Temperature difference between inlet / outlet water

MIPM option scheme

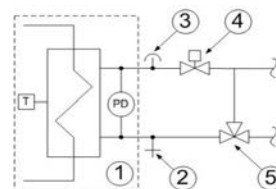

1. Internal exchanger with temperature probe, pressure switch
2. Drainage bibcock
3. Vent valve
4. Hand shut-off valve
5. Manual activation three-way valve for by-pass and manual shut off

ACIE - Internal exchanger anti-ice protection heater

The option makes it possible to avoid the formation of ice in the plate exchanger and to preserve its correct operation. This is an electric heating element fastened to the outside of the exchanger. It activates if the water temperature drops below a set limit. The device is recommended during the winter when the unit is in stand-by or if the system is not in use for long periods of time.

The device is installed and wired built-in the unit.



When the unit is electrically disconnected, the device is not operating.



The device only protects the water side exchanger. Anti-freeze protection of the plumbing connections is the responsibility of the client.

Accessories separately supplied

CMSLWX - LonWorks communication serial module

It allows the serial connection to supervision systems, using LonWorks as the communication protocol. It allows access to a list of operating variables, control and alarms compliant with the Echelon standard.

With this accessory, each unit can communicate with the main supervisor systems such as Trend, Johnson Controls, PlantVisor.

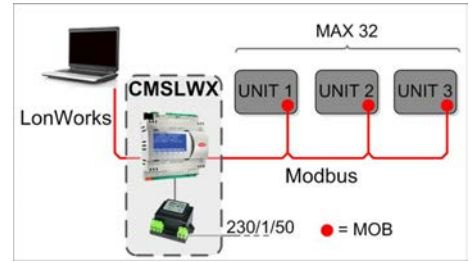

The device needs to be combined with the RS485 serial port option with Modbus protocol.



The package includes the transformer, which is powered by 230/1/50, and the Gateway of communication between the supervisor and the Modbus serial line. The configuration and management of the LonWorks network are the responsibility of the Customer.



The device is prearranged to mounting in DIN rail, for external installation (7 DIN modules, installed by the customer)

BACX - BACnet communication serial module

Allows to perform the serial connection to supervision systems by using BACnet as a communication protocol. It allows the access to the entire list of operating variables, controls and alarms

With this accessory, each unit can communicate with the main supervisor systems such as Trend, Johnson Controls, PlantVisor.

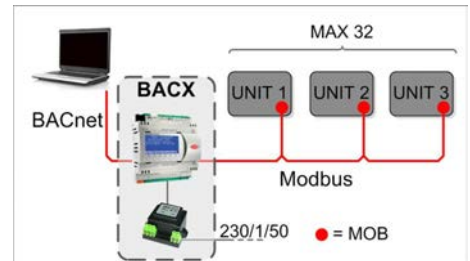

The device needs to be combined with the RS485 serial port option with Modbus protocol.



The package includes the transformer, which is powered by 230/1/50, and the Gateway of communication between the supervisor and the Modbus serial line. The configuration and management of the BACnet network are the responsibility of the customer.



The device is prearranged to mounting in DIN rail, for external installation (7 DIN modules, installed by the customer)

PF500X - Front air supply plenum H=500mm

The plenum allows you to introduce frontally the treated air, it must be installed at the supply opening using screws. It's made of galvanized and painted in color RAL 9001 and equipped with supply grille with a double row of adjustable fins with protective grille.

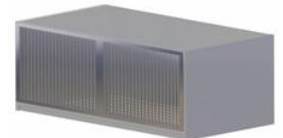

PO3X - Supply plenum on three sides

The plenum allows you to introduce the treated air on three sides, it must be installed with screws on the outlet. It's made of galvanized and painted in color RAL 7016, and is equipped with supply grille with a double row of adjustable fins with protective grille.



Available from size 31 to size 81

AMRX - Rubber anti-vibrating dampers

Mounts can be adjusted in height, and in case of irregular flooring.

They are made of a zincplated metric screw, reinforced polyamide head, nitrilic NBR rubber disc with antivibration features (70 shore)



IFWX - Steel mesh strainer on water side

The device is located up the line from the plate exchanger to keep it from getting dirty from possible impurities in the plumbing circuit. The mechanical filter in stainless steel mesh is easily removable for periodic maintenance and cleaning.

STEEL KNIT FILTER PRESSURE DROP

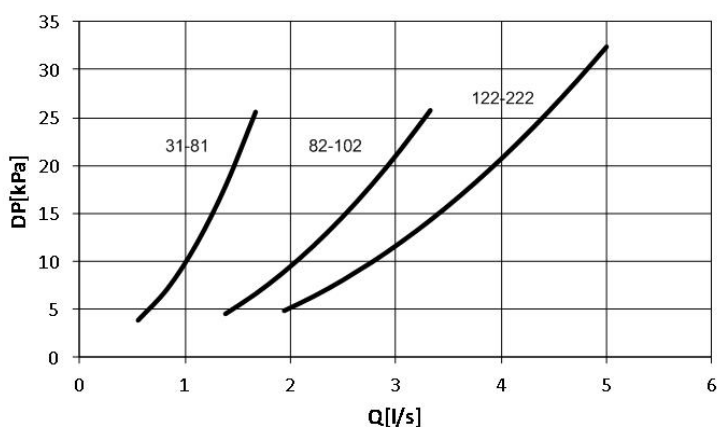

Q[l/s]= WATER FLOW RATE
DP = water side pressure drops (kPa)



Note: the pressure drops are referred to the clean filter



To carry out routine maintenance there should be appropriate shut-offs on the hydraulic line.

STEEL MESH STRAINER FEATURES

Size	82-102	122-222
Water fitting diameter	1" 1/4	1" 1/2
System side water fittings	FEMALE	FEMALE
Unit side water fittings	FEMALE	FEMALE
Degree of filtration	600µm	600µm



Option compatibility

Option compatibility		
REF.	DESCRIPTION	
Accessories		
CHW2	two-rows hot water coil	Δ
3WVPX	Modulating 3-way valve	◇ ¹
3WVM	Modulating 3-way valve	0 ²
EH	Electric heaters.	Δ
Refrigeration circuit		
EVE	Electronic expansion valve	√
MHP	High and low pressure gauges	0
CPHG	hot gas re-heating coil	Δ ²
Aeraulic circuit		
FPG4	Pleated air filter class G4 (EN779 norm)	√
PSAF	Clogged filter differential pressure switch air side	0
PCOSM	Constant supply airflow	0
PF500X	Front air supply plenum H=500mm	◇
P03X	Supply plenum on three sides	◇ ¹
Water circuit		
MIPC	Hydraulic pipework arrangement for loop with constant flow rate with manual valves	0
MIPV	Hydraulic pipework arrangement for loop with variable flow rate with 2 way ON-OFF valve	0
MIPM	Plumbing assembly for loop with disposable water system with 2-way modulating valve	0
IFWX	Steel mesh strainer on the water side	◇
ACIS	Internal exchanger anti-ice protection heater - Water side	0
Electric circuit		
CWM	Electronic room control with display, for wall installation	√
CIWM	Electronic room control with display, for wall installation in built-in box	0
CONTE	Electronic room control with display visible on the unit	0*
CTEM	Temperature ambient control with built-in probe	0*
CSOND	Ambient humidity and temperature control with built-in probes	0*
CUE	External humidifier control with 0-10V command	0
MOB	Serial port RS485 with MODBUS protocol	0
BACX	BACnet serial communication module	◇*
CMSLWX	LonWorks serial communication module	◇*
PM	Phase monitor	0
PFCP	Power factor correction capacitors (cosfi > 0.9)	0
AMRX	Rubber antivibration mounts	◇

√ Standard component

0 Optional component

Δ Optional components that can not be installed at the same time

◇ Accessory separately supplied (optional)

◇* Accessory separately supplied (optional)

available only with MOB

RS485 Serial port with Modbus protocol

0* Match required: temperature control or temperature and humidity control with electronic display unit installed in visible position on the unit

¹ Available from size 31 to size 81

² Available only from size 82 to size 222

Dimensional drawings

Functional spaces

When placing the unit, it is necessary to comply with the functional spaces indicated in the dimensions. Compliance with functional spaces is essential to:

- ensure proper operation of the unit
- allow maintenance technicians easy access to the equipment compartments
- protect authorized operators and exposed persons.

SERIE CAS-X 31-51

DAA4T31_51_PF500X_0
Date: 05/09/2013

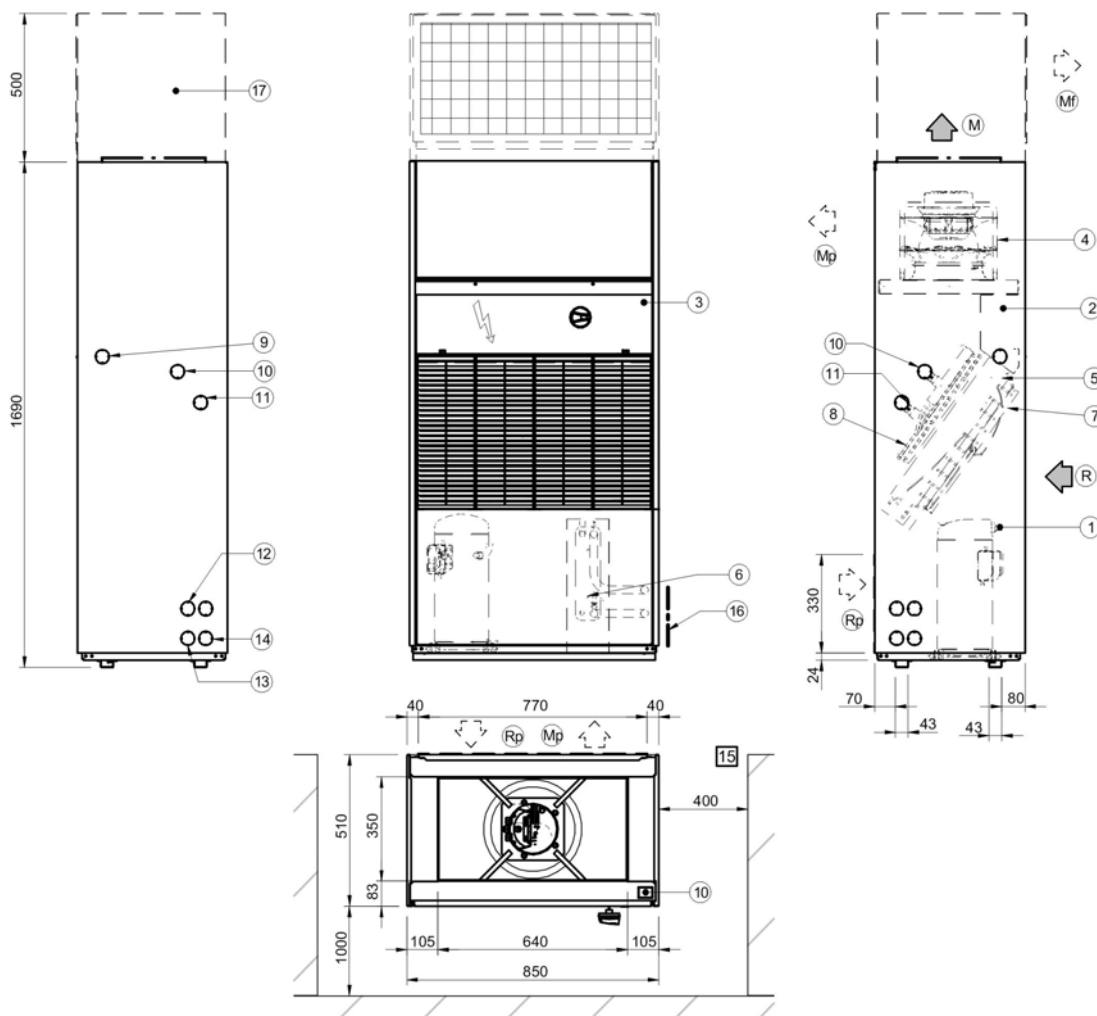

- | | |
|--|--|
| 1. Compressor | 13. Condensate drain |
| 2. Electrical panel | 14. Functional spaces |
| 3. Access to the electrical panel | 15. Water connection side |
| 4. Supply fan | 16. Front air supply plenum (Optional) |
| 5. Direct expansion coil | |
| 6. Plate exchanger | (R) Ambient air return |
| 7. G4 air filters | (M) Ambient air supply |
| 8. Hot water coil (Optional) or Electrical hesters (Optional) | (MP) Rear supply air (Optional) |
| 9. Power input | (MF) Front air supply (Optional) |
| 10. Water line output of the heating coil Ø1" GAS | (RP) Rear air inlet (Optional) |
| 11. Water line input of the heating coil Ø1" GAS | |
| 12. Plate exchanger water outlet Ø 1" plate exchanger water inlet Ø 1" | |

Size		31	41	51
A - Length	mm	850	850	850
B - Width	mm	510	510	510
C - Height	mm	1705	1705	1705
STANDARD UNIT WEIGHTS				
Shipping weight	kg	178	179	188
Operating weight	kg	178	179	188

The presence of optional accessories may result in a substantial variation of the weights shown in the table.

SERIE CAS-X 61-81

DAA4T61_81_PF500X_0
Date: 05/09/2013

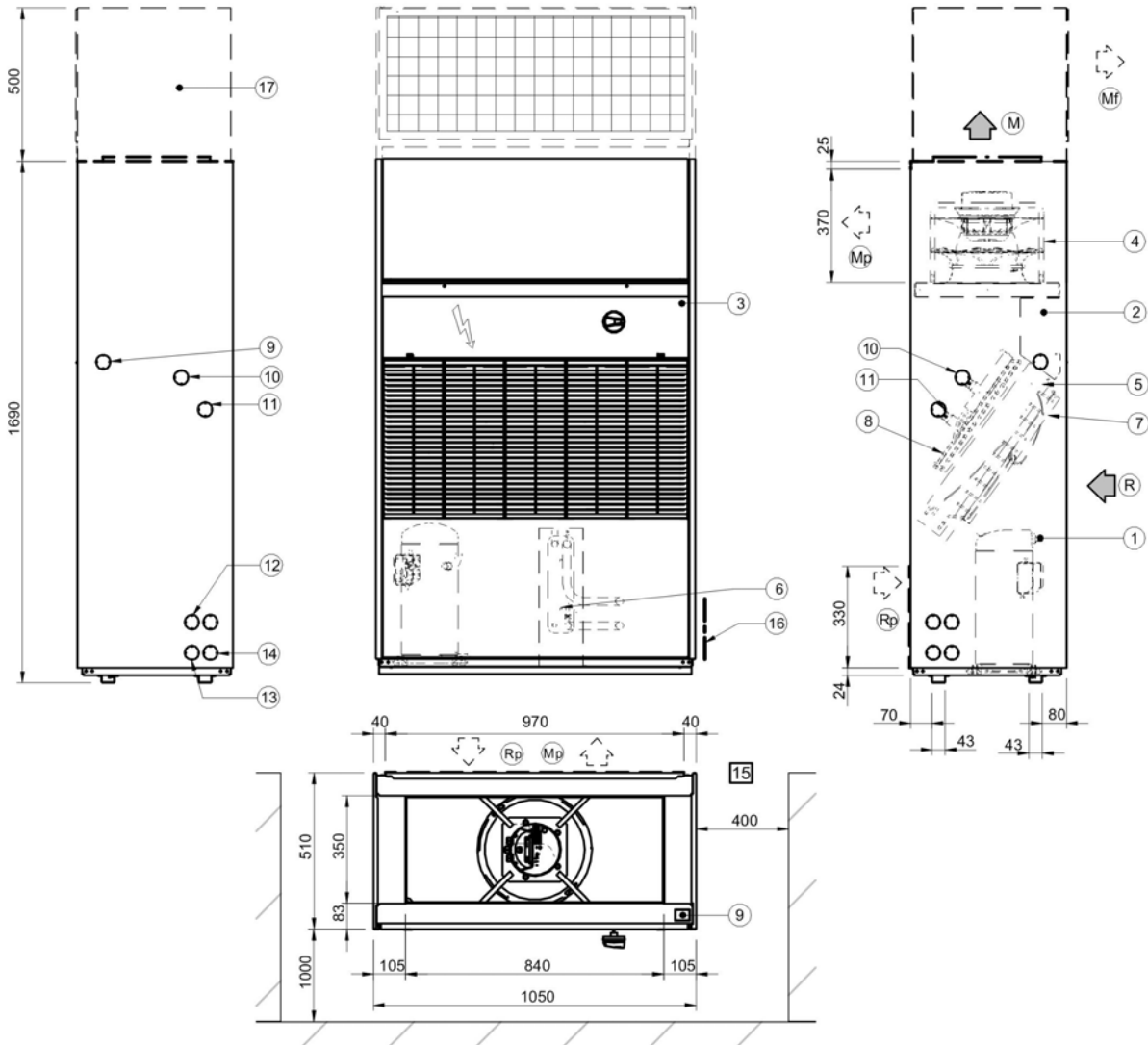

- 1. Compressor
- 2. Electrical panel
- 3. Access to the electrical panel
- 4. Supply fan
- 5. Direct expansion coil
- 6. Plate exchanger
- 7. G4 air filters
- 8. Hot water coil (Optional) or -Electrical hesters (Optional)
- 9. Power input
- 10. Water line output of the heating coil Ø1" GAS
- 11. Water line input of the heating coil Ø1" GAS
- 12. Plate exchanger water outlet ø 1"
- 13. Plate exchanger water inlet Ø 1"
- 14. Condensate drain
- 15. Functional spaces
- 16. Water connection side
- 17. Front air supply plenum (Optional)

- (R) Ambient air return
- (M) Ambient air supply
- (Mp) Rear supply air (Optional)
- (MF) Front air supply (Optional)
- (Rp) Rear air inlet (Optional)

Clearance access recommended

Size		61	71	81
A - Length	mm	1050	1050	1050
B - Width	mm	510	510	510
C - Height	mm	1705	1705	1705
STANDARD UNIT WEIGHTS				
Shipping weight	kg	207	208	210
Operating weight	kg	207	208	210

The presence of optional accessories may result in a substantial variation of the weights shown in the table.

SERIE CAS-X 82-102

DAA4T82_102_PF500X_0
Date: 05/09/2013

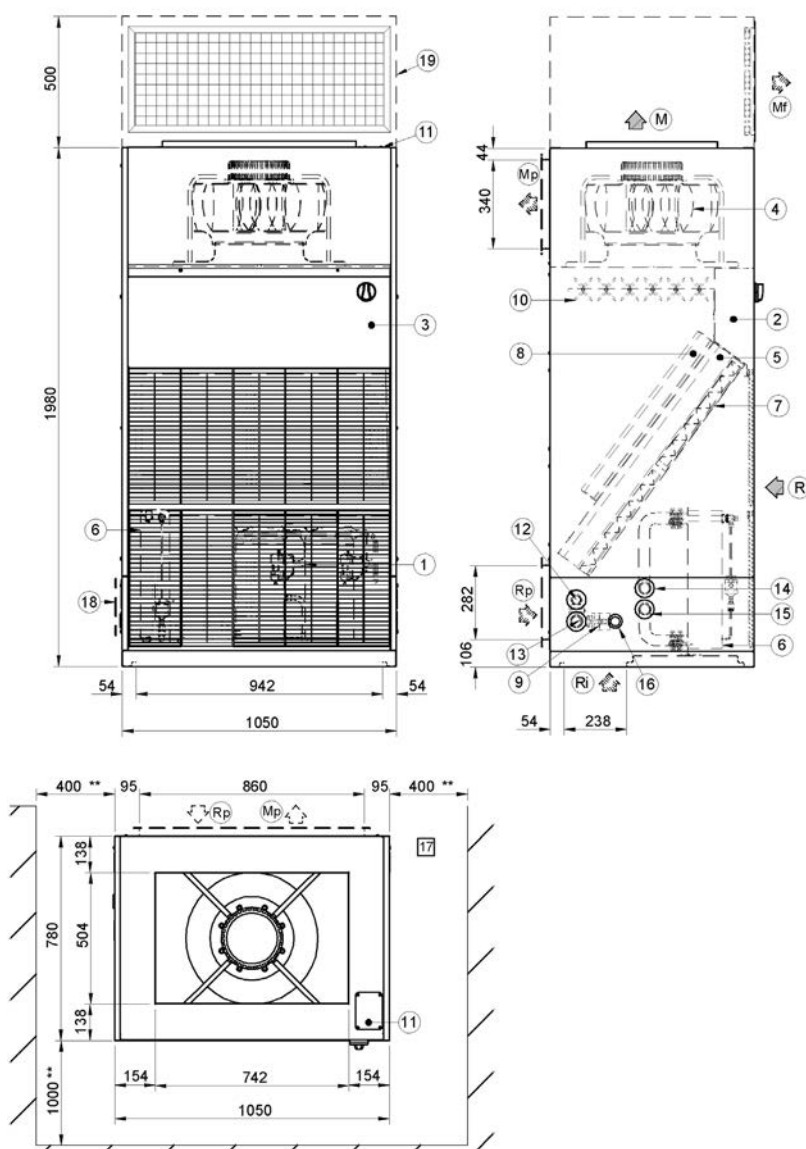

- 1. Compressor
 - 2. Electrical panel
 - 3. Access to the electrical panel
 - 4. Supply fan
 - 5. Direct expansion coil
 - 6. Plate exchanger
 - 7. G4 air filters
 - 8. Hot water coil (Optional) - Post-heatig coil (Optional)
 - 9. 3 ways-valve (optional)
 - 10. Electrical hesters (Optional)
 - 11. Power input
 - 12. Water line output of the heating coil Ø1" GAS
 - 13. Water line input of the heating coil Ø1" GAS
 - 14. Exchanger water outlet Ø 1 1/4" F GAS
 - 15. Exchanger water inlet Ø1" 1/4 GAS
 - 16. Condensate drain
 - 17. Functional spaces
 - 18. Water connection side
 - 19. Front air supply plenum (Optional)
- (R) Ambient air return
(M) Ambient air supply
(MP) Rear supply air (Optional)
(MF) Front air supply (Optional)
(RP) Rear air inlet (Optional)
(RI) Floor air inlet (Optional)

Clearance access recommended

Size		82	102
A - Length	mm	1050	1050
B - Width	mm	780	780
C - Height	mm	2000	2000
STANDARD UNIT WEIGHTS			
Shipping weight	kg	310	315
Operating weight	kg	310	315

The presence of optional accessories may result in a substantial variation of the weights shown in the table.

SERIE CAS-X 122-162

DAA4T122_162_PF500X_0
Date: 05/09/2013

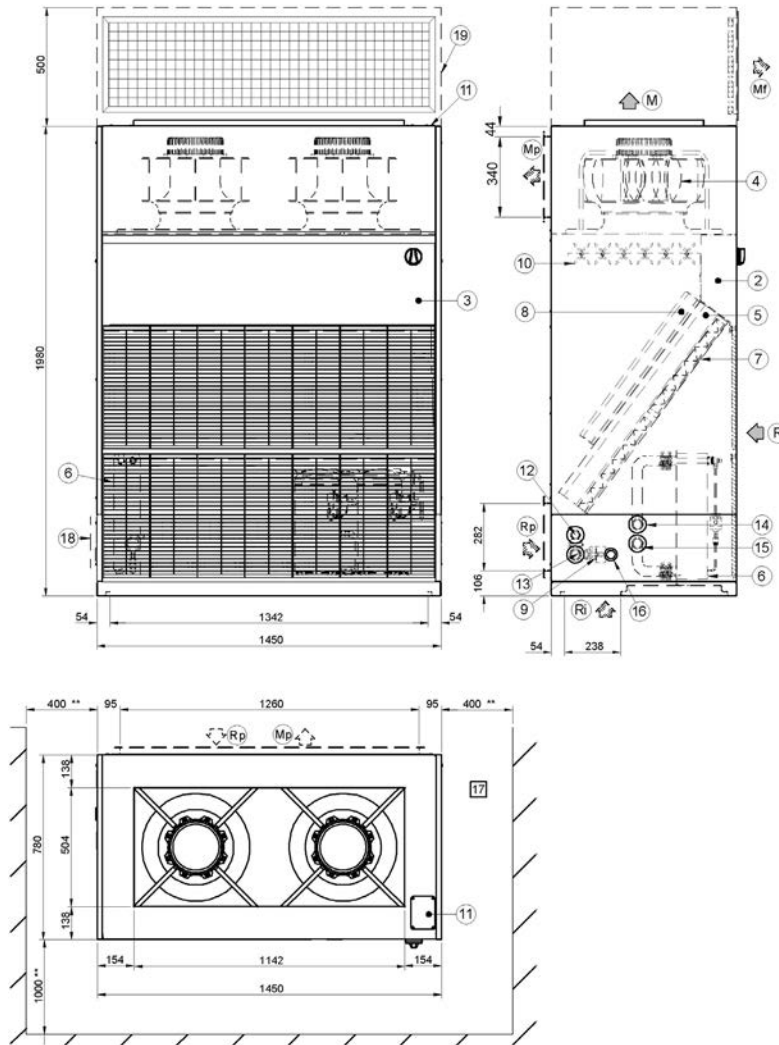

1. Compressor
2. Electrical panel
3. Access to the electrical panel
4. Supply fan
5. Direct expansion coil
6. Plate exchanger
7. G4 air filters
8. Hot water coil (Optional) - Post-heatig coil (Optional)
9. 3 ways-valve (optional)
10. Electrical hesters (Optional)
11. Power input
12. Water Line Output OfThe Handling Coil Ø1 1/2" GAS
13. Water Line Input OfThe Heating Coil Ø1 1/2" GAS
14. Exchanger water outlet Ø 1 1/4" F GAS
15. Exchanger water inlet Ø1" 1/4 GAS
16. Condensate drain
17. Functional spaces
18. Water connection side
19. Front air supply plenum (Optional)

- (R) Ambient air return
(M) Ambient air supply
(MP)Rear supply air (Optional)
(MF)Front air supply (Optional)
(RP) Rear air inlet (Optional)
(RI)Floor air inlet (Optional)

Clearance access recommended

Size		122	162
A - Length	mm	1450	1450
B - Width	mm	780	780
C - Height	mm	2000	2000
STANDARD UNIT WEIGHTS			
Shipping weight	kg	400	410
Operating weight	kg	400	410

The presence of optional accessories may result in a substantial variation of the weights shown in the table.

SERIE CAS-X 182-222

DAA4T182_222_PF500X_0
Date: 05/09/2013

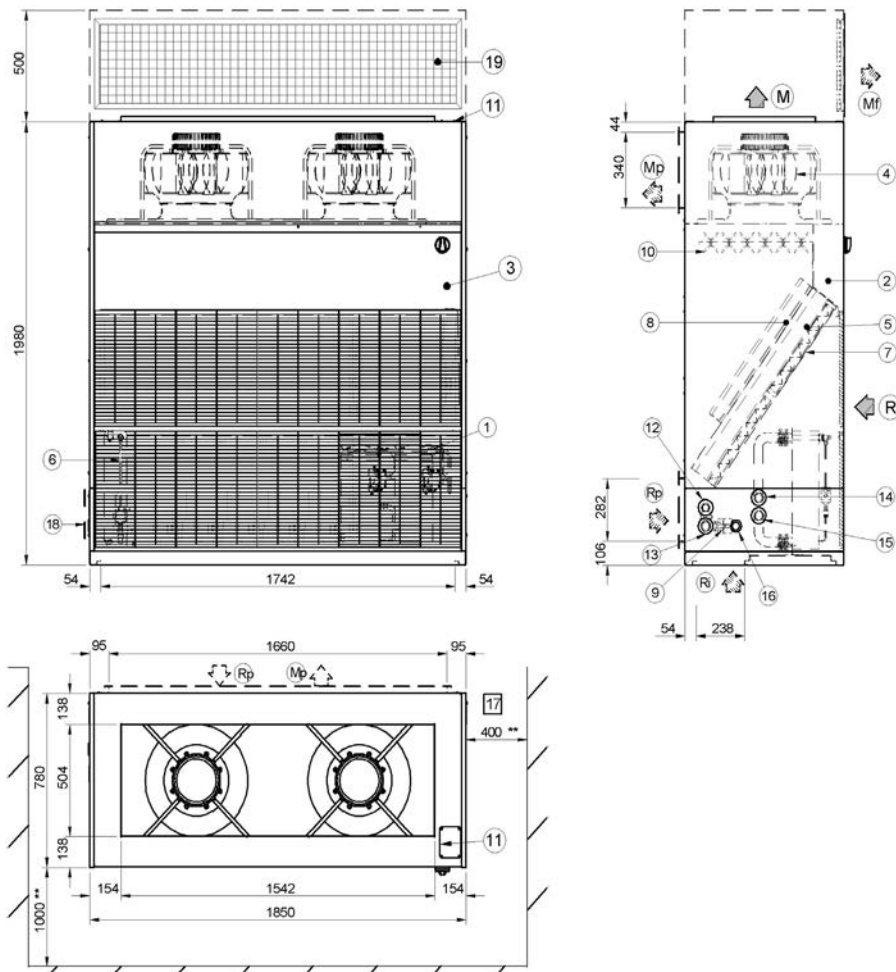

- 1. Compressor
 - 2. Electrical panel
 - 3. Access to the electrical panel
 - 4. Supply fan
 - 5. Direct expansion coil
 - 6. Plate exchanger
 - 7. G4 air filters
 - 8. Hot water coil (Optional) - Post-heatig coil (Optional)
 - 9. 3 ways-valve (optional)
 - 10. Electrical hesters (Optional)
 - 11. Power input
 - 12. Water Line Output Of The Handling Coil Ø1 1/2" GAS
 - 13. Water Line Input Of The Heating Coil Ø1 1/2" GAS
 - 14. Exchanger water outlet Ø 1 1/4" GAS
 - 15. Exchanger water inlet Ø1" 1/4 GAS
 - 16. Condensate drain
 - 17. Functional spaces
 - 18. Water connection side
 - 19. Front air supply plenum (Optional)
- (R) Ambient air return
 - (M) Ambient air supply
 - (Mp) Rear supply air (Optional)
 - (MF) Front air supply (Optional)
 - (RP) Rear air inlet (Optional)
 - (Ri) Floor air inlet (Optional)
- Clearance access recommended

Size		182	222
A - Length	mm	1850	1850
B - Width	mm	780	780
C - Height	mm	2000	2000
STANDARD UNIT WEIGHTS			
Shipping weight	kg	490	500
Operating weight	kg	490	500

The presence of optional accessories may result in a substantial variation of the weights shown in the table.

Index of contents

ROOMPack contains all components for the system simplification.....	2
Easy to position in available settings or technical spaces	3
Is easy to use	3
The reliable, highly energy efficient solution.....	4
Modular Scroll technology for maximum efficiency with part loads	4
Stable and reliable operating	4
Even more silent composite structure plug-fans.....	5
Easy to use in the small and large plants.....	6
Ready to be connected to the water mains.....	7
Standard unit technical specifications	8
General technical data.....	10
Electrical data	10
Electrical input of optional components.....	11
Sound levels	11
Operating range (Cooling)	11
Performances in cooling.....	12-17
Supply/return electric fan performances - Standard air flow	18
Supply/return fan performance - Reduced air flow.....	19
Supply/return fan performance - High air flow	20
Pressure drops of optional components.....	21
Standard unit water circuit pressure drops.....	21
Accessories	22
Accessories separately supplied	30
Option compatibility.....	32
Dimensional drawings.....	33-37

Page intentionally left blank

**CLIVET SPA**

Via Camp Lonc 25, Z.I. Villapaiera - 32032 Feltre (BL) - Italy
Tel. + 39 0439 3131 - Fax + 39 0439 313300 - info@clivet.it

CLIVET UK LTD (Sales)

4 Kingdom Close, Segensworth East - Fareham, Hampshire - PO15 5TJ - United Kingdom
Tel. + 44 (0) 1489 572238 - Fax + 44 (0) 1489 573033 - info@clivet-uk.co.uk

CLIVET AIRCON LTD (Service and Maintenance Division)

Units F5&F6 Railway Triangle Ind EST, Walton Road - Portsmouth, Hampshire - PO6 1 TG - United Kingdom
Tel. + 44 (0) 2392 381235 - Fax + 44 (0) 2392 381243 - info@clivetaircon.co.uk

CLIVET ESPAÑA COMERCIAL S.L. (Sales)

Calle Gurb, 17 1º 1ª - 08500 Vic, Barcelona - España
Tel. + 34 93 8606248 - Fax + 34 93 8855392 - info@clivetcomercial.es

CLIVET ESPAÑA S.A.U. (Service and Maintenance Division)

Calle Real de Burgos nº12 - 28860, Paracuellos del Jarama, Madrid - España
Tel. + 34 91 6658280 - Fax + 34 91 6657806 - info@clivet.es

CLIVET GmbH

Hummelsbütteler Steindamm 84, 22851 Norderstedt - Germany
Tel. + 49 (0) 40 32 59 57-0 - Fax + 49 (0) 40 32 59 57-194 - info.de@clivet.com

CLIVET NEDERLAND B.V.

Siliciumweg 20a, 3812 SX Amersfoort - Netherlands
Tel. + 31 (0) 33 7503420 - Fax + 31 (0) 33 7503424 - info@clivet.nl

CLIVET RUSSIA

Elektrozavodskaya st. 24, office 509 - 107023, Moscow, Russia
Tel. + 74956462009 - Fax + 74956462009 - info.ru@clivet.com

CLIVET MIDEAST FZCO

Dubai Silicon Oasis (DSO), High Bay Complex, Ind Unit No. 3 - PO Box 28178 - DUBAI, UAE
Tel. + 97 14 3208499 - Fax + 97 14 3208216 - info@clivet.ae

CLIVET AIRCONDITIONING SYSTEMS PRIVATE LTD

3C3, Gundecha Onclave - Kherani Road, Saki Naka, Andheri (East), Mumbai 400 072 (INDIA)
Tel. + 91 - 22 - 6193 7000 - Fax + 91 - 22 - 6193 7001 - sales.india@clivet.com