

CLIVETPack²

Direct expansion high efficiency packaged rooftop air conditioner for medium attendance areas



CRH-XHE2 49.4-110.4 RANGE

WATER-AIR HEAT PUMP R-410A

Air flow-rate from 22000 to 60000 m³/h



- ▶ Two single refrigeration circuits
- ▶ R-410A scroll compressors connected in tandem
- ▶ High seasonal efficiency (HSE)
- ▶ Energy recovery of exhaust air
- ▶ Maximum compactness
- ▶ Variable airflow



Table of contents

Features and benefits	4
Unit configuration.....	16
Supply and return configurations	17
Unit technical features	18
General technical data.....	21
Sound levels.....	22
Electrical data	23
Electrical input of optional components.....	24
Pressure drops of optional components.....	24
Operating range (Cooling).....	25
Operating range (Heating).....	25
Accessories	26
Water connections diagrams	39
Accessories separately supplied	41
Performance.....	43
Handling electric fan performance.....	51
High static pressure electric fan performance.....	54
Exhaust electric fan performance	57
Option compatibility.....	58
Dimensional drawings.....	60

For many businesses, success depends on the right comfort of the users

Correct air conditioning is a fundamental component to manage various retail surfaces. Optimal temperature and humidity, air purification and proper ventilation are essential factors to ensure occupancy of these areas for both users and operators, regardless of external conditions. This is what happens in supermarkets and hypermarkets, shopping centres, stations, airports and industrial warehouses. Fresh air is even more crucial for commercial catering to control odours and vapours. Finally, also in technical facilities ventilation and air-conditioning are often essential for the correct operation of the equipment they contain.



CLIVETPack CRH-XHE2 delivers all the technological evolution by Clivet to the applications for middle attendance

The specialised ranges for applications with medium to high occupancy are widely used in industrial and commercial buildings. Their success is based on high energy efficiency, compactness, versatility, maintenance and operation simplicity.

Four main configurations providing different air flow control. Each one can be integrated by a broad range of accessories that customise the product based on the application.

CAK configuration: single fan section for full recirculation

For air conditioning applications only, without the need for air renewal. The supply fan section provides the required supply and return available static pressure.

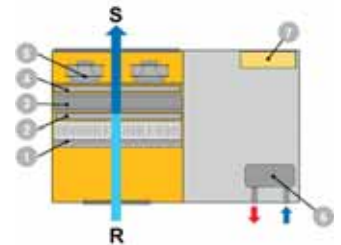

CBK configuration: single fan section for recirculation and fresh air

For applications where you need to keep the room in over-pressure, with the option of controlling a particular fresh air flow.

As for the CAK configuration, the supply fan section provides the supply and return available static pressure.

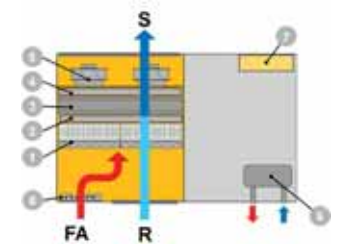

CCK configuration: double fan section for recirculation, fresh air, exhaust and FREE-COOLING

For applications with automatic air renewal and free-cooling function control. In addition to the parts contained in the CBK configuration, the unit is equipped with an exhaust section which allows the partial renewal in the environment or the cooling using directly the outdoor air.

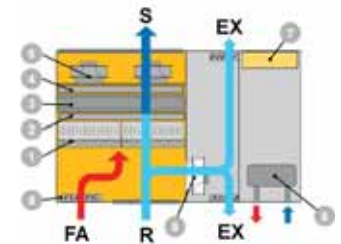

CCKP configuration: double fan section with fresh air, exhaust and THOR thermodynamic recovery

For applications with automatic air renewal and free-cooling function control. In addition to the parts contained in the CCK configuration, the unit is equipped with an exhaust section with innovative thermodynamic energy recovery of the exhaust air through a dedicated THOR (THERmodynamic Overboost Recovery) exchanger.

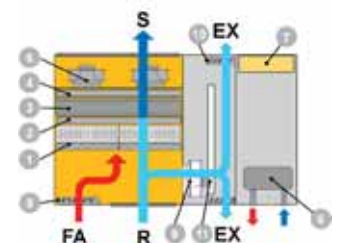

R. Return air
S. Supply air
FA. Fresh air
EX. Exhaust air

1. G4 efficiency filters + H10 equivalent electronic filters
2. Hot water exchanger or electric heaters
3. Handling exchanger

4. Hot gas reheating exchanger
5. Return + supply fan section
6. Source side exchanger
7. Electrical panel
8. Renewal air damper
9. Exhaust fan
10. Overpressure damper
11. Thermodynamic recovery exchanger, THOR

CLIVETPack series for medium attendance applications

SMARTPACK2

CKN-XHE2i 7.1 - 14.2 reversible heat pump
 Nominal airflow: 3200 - 10500 m³/h
 Cooling capacity: 20 - 46 kW
 Configurations:
 CAK single fan section for full recirculation
 CBK single fan section for recirculation and fresh air
 CCK double fan section for recirculation, fresh air, exhaust, thermodynamic recovery



CLIVETPack²

CSRN-XHE2 15.2 - 44.4 HSE reversible heat pump
 Nominal airflow: 9000 - 25000 m³/h
 Cooling capacity: 48 - 147 kW
 Configurations:
 CAK single fan section for full recirculation
 CBK single fan section for recirculation and fresh air
 CCK double fan section for recirculation, fresh air, exhaust, thermodynamic recovery
 CCKP double fan section with fresh air and THOR thermodynamic recovery



Grandezze
15.2 ÷ 30.4

CLIVETPack²

CSRT/N-XHE2 49.4 - 110.4 solo freddo / pompa di calore reversibile
 Portata aria nominale: 22000 - 60000 m³/h
 Potenza frigorifera: 155 - 376 kW
 Configurazioni:
 CAK singola sezione ventilante per tutto ricircolo
 CBK singola sezione ventilante per ricircolo ed aria di rinnovo
 CCK doppia sezione ventilante per ricircolo, aria di rinnovo, espulsione, recupero termodinamico
 CCKP doppia sezione ventilante con aria di rinnovo e recupero termodinamico THOR



CLIVETPack²

CRH-XHE2 14.2 - 110.4 reversible heat pump
 Nominal airflow: 8500 - 60000 m³/h
 Cooling capacity: 52 - 392 kW
 Configurations:
 CAK single fan section for full recirculation
 CBK single fan section for recirculation and fresh air
 CCK double fan section for recirculation, fresh air, exhaust, thermodynamic recovery
 CCKP double fan section with fresh air and THOR thermodynamic recovery



Grandezze
14.2 ÷ 25.4

Clivet series for high attendance applications

CLIVETPack²

CSNX-XHE2 12.2 - 44.4 reversible heat pump
 Nominal airflow: 4000 - 20000 m³/h
 Fresh airflow up to 80%
 Cooling capacity: 47 - 174 kW
 Configurations:
 CCK double fan section for recirculation, fresh air, exhaust, thermodynamic recovery
 CCKP double fan section with fresh air and THOR thermodynamic recovery



Grandezze
12.4 ÷ 24.4

Clivet series for full fresh air application

ClivetPACK² FFA

CSRT/N-XHE2 FFA 12.2-24.4 cooling only / reversible heat pump
 Nominal airflow: 3000 - 9000 m³/h
 Cooling capacity: 33 - 90 kW
 Configurations:
 CBFFA Configuration for fresh air inlet
 CCFFA Configuration for fresh air inlet with outlet



Complete and decentralised systems

The necessary heat or cooling energy is only produced where and when needed, for this they can be independently be installed next to the zone to be conditioned with a considerable system saving.

The packaged design of all of the plant engineering parts are contained inside the unit, already assembled and inspected.

The unit includes plug and play logic. Installation and later maintenance operations are easy and quick.

Comfort and air quality in only one product

Temperature and humidity control throughout the year

The unit acts on the overall heat load generated by the outdoor air and by the ambient loads.

The particular reversible heat pump technology is also suitable for applications in cold climates, and can be integrated where necessary to the other integrated heating options like electrical heaters, hot water coil, condensed gas with burner heating module with modulating control.

The unit can also automatically control the relative humidity in the served ambient. In cooling mode the dehumidification function can be completed by a post-heating device with hot gas recovery and on the FREE-COOLING enthalpy control. In heating mode, the steam humidifier or the evaporating heater increases the humidity introduced into the air to maintain the desired value in the ambient.

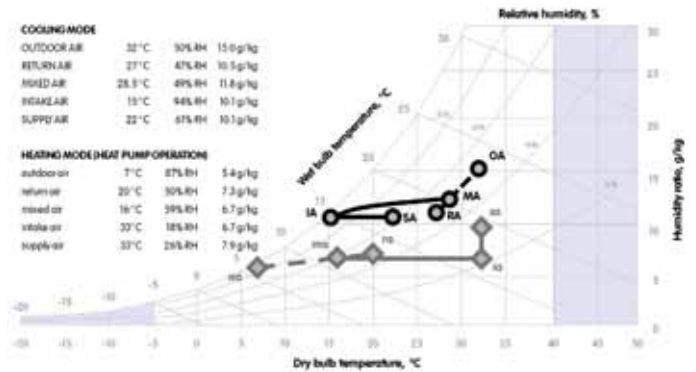

Treatment example at full load for CLIVETPack model CRH-XHE2 49.4 in standard airflow. Outdoor airflow equal to 30% of that treated. Heating carried out with a heat pump. Unit complete with 'post-heating with hot gas' and 'vapour humidifier of 15 kg/h' options.

Automatic management of the air renewal

The automatic logic of the air renewal:

- Carries out the transient steady state in all recirculation mode, to reduce its duration and quickly reach comfort conditions
- Once these conditions have been reached, it operates with fixed open damper, based on the users preferred settings
- Carry out the FREE-COOLING as soon as the external conditions allow it
- In models fitted with air quality control, modulates the outdoor air renewal quantity, therefore guaranteeing the desired air quality with substantial energy and economic savings

Air filtering

Air filtering is an essential function for ensure proper well-being and hygiene conditions are maintained in the areas served. This is why it is subject to special regulations based on specific applications. The units are fitted as standard with large G4 filters with low pressure drops on the treatment area.

Very high filtration efficiency

As a second stage of filtration, there are F7 high efficiency filters or innovate electronic filters available. The efficiency of the fitted electronic filters is equivalent to the H10 classification used in traditional filters, or rather the class identification such as "absolute filter". They are efficient even on fumes, fine dust, particles PM10, PM2.5, PM1, bacteria, germs and virus.

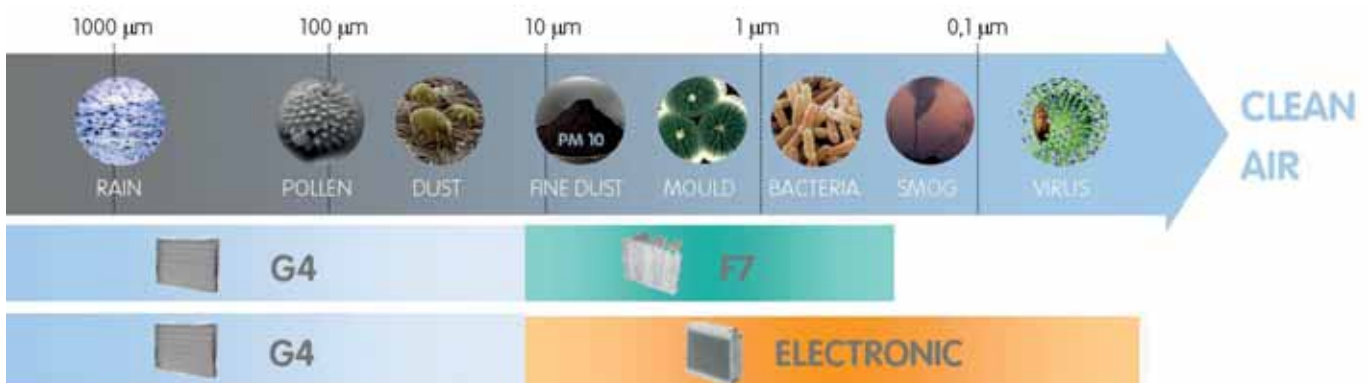

Automatic control of the air quality

When the area is occupied in partial mode, a minor air change is necessary. The air quality probe (which is sensitive to the CO₂ tracer) is positioned on the return of the served ambient and automatically determines the opening of the outdoor air damper to give the correct renewal and avoid waste.

Similarly, the probe is also sensitive to VOC (Volatile Organic Compounds) also acts in the presence of tobacco smoke, formaldehyde (for example from solvents, deodorants, glues, paint, detergents), cooked foods.

The electronic filters reduce the energy necessary for ventilation

The highest filtration efficiency is obtained with practically no pressure drops.

This depends on the metal pre-filter that is found upstream of the plate and withholds the coarse particles. Moreover, the metal pre-filter homogeneously distributes the air flow and contributes to the containment of the magnetic field generated during operation.

The energy for the ventilation is thus reduced by more than 10%.

The pressure drops remain unchanged with the progressive fouling.

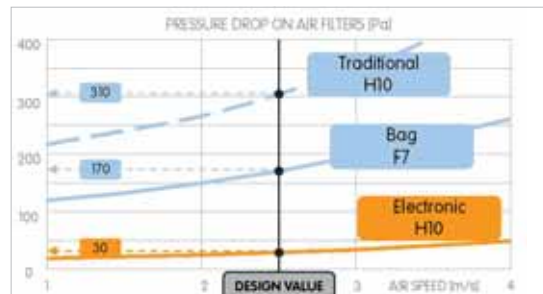

High energy efficiency within the annual cycle

Increases the building value

The high efficiency reduces the complex primary energy requirements and the CO₂ emissions compared to traditional solutions. It follows the improvement of the energy class of the building and therefore its value on the property market.

It is often possible to access the foreseen benefits to promote the use of the unit at low consumption.

The small consumptions also reduce the environmental impact of the system, further improving the public image on this sensitive issue.

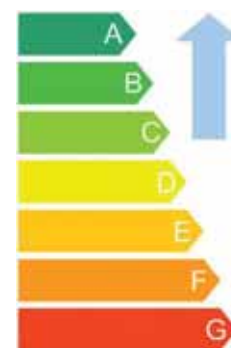

Part load efficiency determines the seasonal efficiency

The system is required to generate maximum capacity only for a short amount of time. Therefore, it is essential to have the maximum efficiency under part-load conditions. This is the only way to actually reduce overall yearly consumptions.

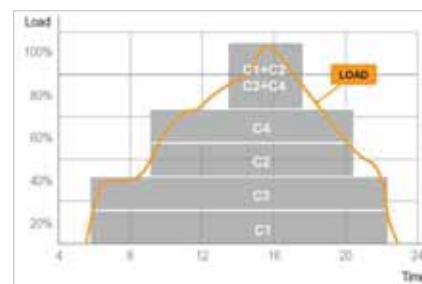

Modular Scroll technology boosts performance at part load

Since the maximum capacity is requested only for short periods of time, it is fundamental to place the maximum efficiency in the partial load conditions. The unit uses high efficiency Scroll compressors. The advantages are:

- compressors manufactured in large ranges, with strict quality controls and maximum reliability thanks to the high production volumes
- the refrigerant circuit uses two compressors, almost always of different sizes in order to obtain more control steps. This way, only the necessary energy is supplied

Size 14.2 excluded.

THE SEQUENTIAL DEACTIVATION OF THE COMPRESSORS INCREASES EFFICIENCY



Doubled efficiency

The heat exchange surface is sized for full capacity operation. Under part load condition, some compressors are automatically deactivated. Under this condition, in fact, the compressors in operation make use of a much larger surface.

This entails a reduced condensation temperature and an increased evaporation temperature. This way, the compressor capacity consumption is reduced with respect to the yield thereby increasing the overall efficiency of the unit.

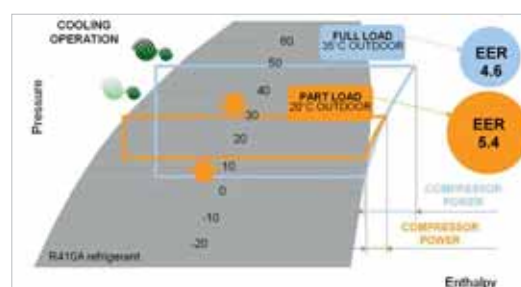

Example referred to CRH-XHE2 60.4 in the all recirculation operation, according to EN 14511

Versatility of reversed blades rotor

This particular type of rotor offers a wider field of operation compared with a traditional forward curved blade fan. When necessary, this can supply high static pressures simply by varying the number of revolutions. The accurate balancing and the self-lubricating bearings ensure its rotating stability over time.



Ventilation electronically controlled

An important expense entry in the systems management costs is represented by the energy consumption for ventilation, then the research for the correct operating conditions on the systems that forces them to carry out long and costly operations.

The ventilation technology makes it possible to cut back on both of these operational costs: it runs on fans that are coupled directly to electronic control brushless motors, and the control logic offers additional savings.

The efficiency of the electronic controlled motor

The external rotor electric motor is driven by the continuous magnetic switching of the stator. The advantages are:

- The lack of brushes and the particular power supply increase efficiency by 70%;
- Even the life cycle increases, thanks to the elimination of the brushes' natural abrasive erosion effects;
- The electronic control allows a progressive start-up and also includes a "soft start" solution, which drastically reduces the starting current of the fan and limits even more the system's electrical commitment.



Advantages of direct coupling (plug fan)

The motor's rotation is transmitted directly to the rotor, without the use of transmissions (belts and pulleys):

- the transmissions' inefficiencies are eliminated;
- the transmissions' wear and maintenance is eliminated.

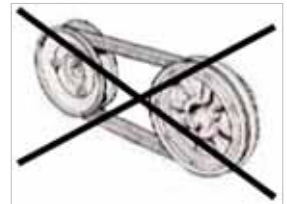

Efficiency of the ventilation system increases by 30%

The comprehensive ventilation system, made up of rotor and motor, is therefore very versatile and efficient.

Consumption is 30% lower than a ventilation system of the same capacity used by traditional units available on the market.

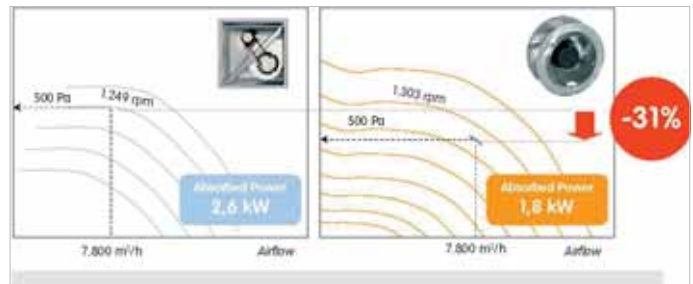

Electrical power absorbed by electric motor, data constructor - Example, referred to flow of 7.800 m³/h with 500 Pa external static pressure.

Applications with textile channels

The fans with electronic control allow choosing the preferred ramp for fan start-up.

The units are therefore suitable for majority of the applications with textile channels for the air distribution.

This versatility remains valid in each management mode of the flow (standard, ECO, Variable flow).



The right air flow for every type of system

By controlling the fan speed, the airflow can be varied and the static pressure capacity can be adapted to the system pressure drop, making the unit start-up particularly simple. The adjustment or modification of the transmission is no longer required as the ventilation system will adapt itself to the system. The possibility to modify the fan start-up ramp makes this unit suitable for most applications with textile air distribution ducting.

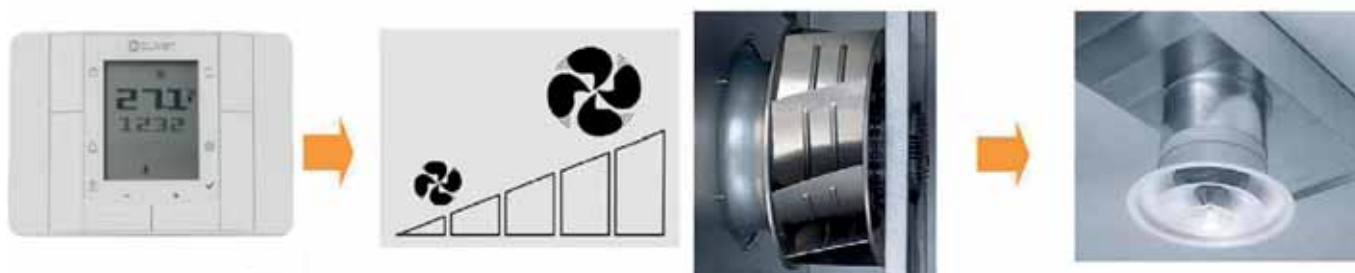

Automatic management of the air flow

Standard mode

The air flow supply remains constant in all heat load conditions and operation modes.

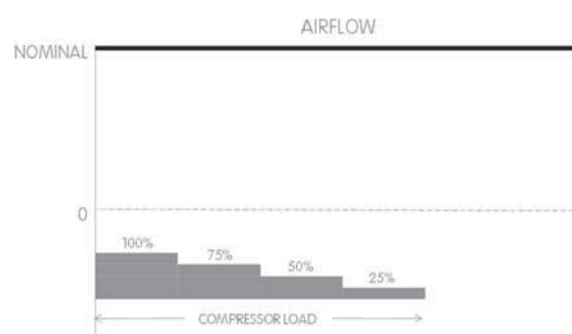

ECO mode

The air flow supply remains constant at varied heat loads and is shutdown when the load is fulfilled (dead zone).

To further increase the energy savings in this condition, it is also possible to set less demanding operation setpoints for the unit in respect to the standard mode.

This function is indicated for the thermal maintenance of the served area in case it is temporarily not used, which can for example occur at night.

The ECO mode can be activated:

- Manually
- Automatically by means of the Clivet supervision System

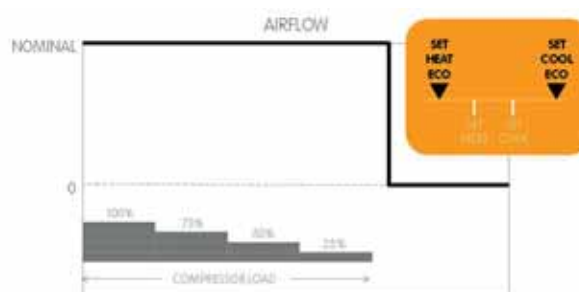

The unit performs periodic start-ups of the ventilation to measure the ambient temperature.

Variable airflow

The air flow supply varies depending on the heat load, up to a minimum value compatible with the distribution system and the chosen air diffusion.

The ventilation remains active at the minimum speed even when the load is fulfilled (at satisfied set point).

This option allows a further energy savings

- The movement of the air is always active during the operation of the rooftop unit
- It determines an annual energy consumption comparable or even greater than the compressors.
- The reduction of 20% of the flow generates a saving of 50% on energy absorbed by the ventilators
- With a reduction of the flow equal to 40%, the saving for ventilation exceeds 70%
- The variable airflow can therefore lead to a saving of 30% on an overall electrical consumption of the unit

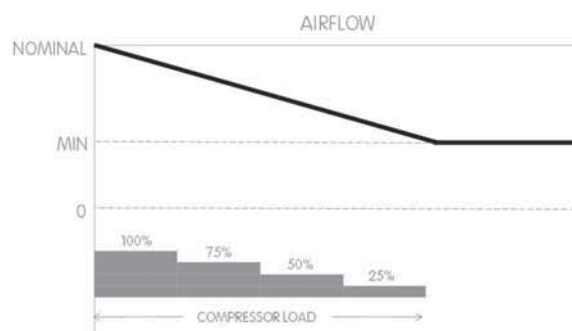

Set-point automatic compensation

With this function as standard, the temperature set-point can automatically vary in view of the outdoor temperature and of the User settings:

- Further increases the energy saving
- Reduces the temperature difference between the outside and the served area, increasing the user comfort.

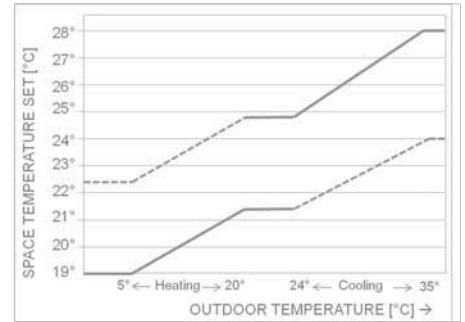

Ambient pressure control

The ambient pressure control device compares the return pressure with the external pressure and compensates any variations by acting on the outdoor air damper.

This way, the unit maintains the relevant ambient pressure desired by the user, who can choose between the overpressure, depression or equal-pressure.

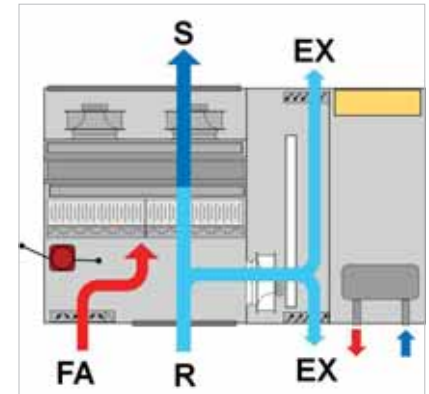

The room pressure control device is fitted as standard in the units with extraction and exhaust (Clivet reference code CCK and CCKP)

FREE-COOLING

As soon as the external conditions allow it, the unit is capable of automatically activating the FREE-COOLING mode, which, keeping the compressors off and drawing in suitably filtered outdoor air allows to cool the served room. This operating mode is especially useful in spring and autumn or in case of high ambient loads. It allows substantial reduction of the unit energy consumption and compressors.

To obtain the maximum energy saving, the FREE-COOLING model is activated even when it is not sufficient to supply all the capacity requested. In this case the integration cooling capacity is supplied from cooling by means of compressors.

At reduced load, or even with rigid outdoor air temperatures, the cooling capacity in FREE-COOLING mode is controlled by means of a modulation of the outdoor air damper.

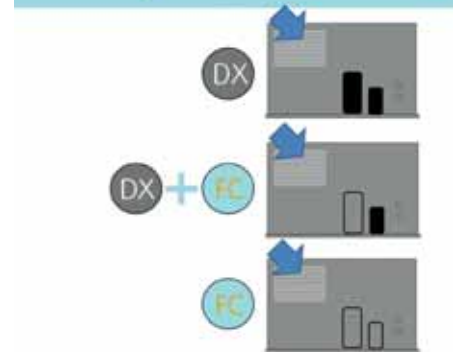

Stable and reliable operation

The electronic expansion valve (EEV) adapts rapidly and precisely to the actual load required for usage, allowing stable and reliable adjustment in comparison with mechanical thermostatic valves (TEV). This results also in a further increase in efficiency and longer compressor life. Through control of overheating, it also prevents hazardous phenomena for the compressors, such as overtemperature and return of fluids, thereby further increasing efficiency and durability.

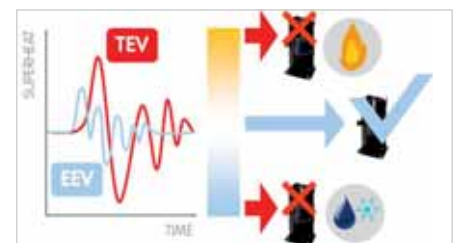

High efficient refrigerant

R410A is the mix of two refrigerants used in equal parts: R32 that supplies the heating capacity and R125 that controls the flammability. It is a chlorine free refrigerant (HFC) with numerous advantages:

- ODP (Ozone Depletion Potential) = 0
- High volumetric effect thanks to the high coefficient global thermal exchange and to the pressure variation (glide) which is almost nil during the evaporation phase
- Elevated density and efficiency, with greater compactness of the refrigeration circuit and therefore the responsible use of materials and small refrigerant quantity, for a reduced environmental impact.

R-410A



Energy recovery from food refrigeration

Modern supermarkets and hypermarkets consume massive amounts of energy every year on food storage. With most of these systems, the heat that they produce is released outdoors through air-cooled condensers.

In winter, energy recovery from cold storage offers new possibilities for energy savings, as it increases the efficiency of the entire air conditioning and food storage system.

Renewable energy heat pump technology

The electric Heat pump technology promotes and provides incentives by the European Union with specific standards, such as the EU Directive 2009/28/CE of April 23rd 2009 that recognises ambient heat as a renewable source.

Compared to a combustion system, the electric heat Pump allows:

- Energy saving and reduction of the CO₂ emissions by an average of 50%
- Use of electric energy, increasingly produced through alternative and renewable sources
- Operation and reduced maintenance reliability
- No fossil combustion and therefore absence of chimney, absence of periodical controls on the emissions in the ambient and no local production of fine dust
- Cost reduction of first investment with the reversible models that use a single system for both heating and cooling.

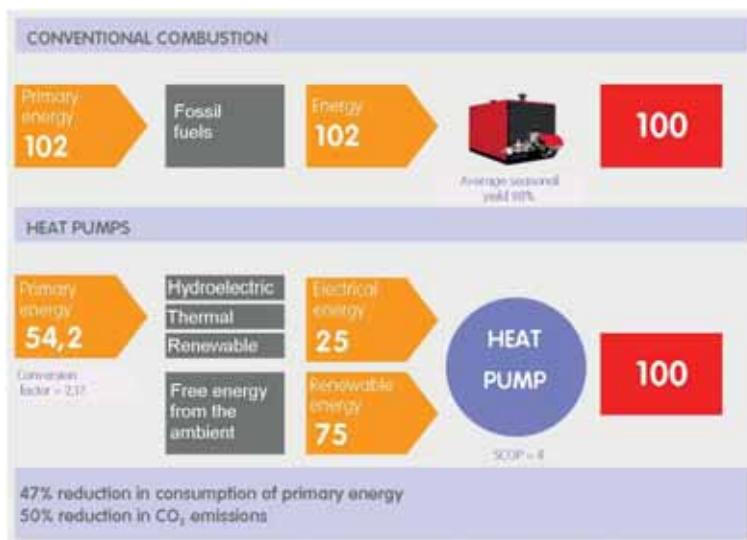

High efficiency heating solutions

The reversible heat pump model is able to also operate with particularly rigid external temperatures. In many locations this condition is determined only for short periods during the effective use of the system. The use of the electric resistance (I) allows to maintain the advantages of the single block solution, in terms of design simplicity and system rational. The electric resistances can in fact intervene automatically like any thermal integration, or with the outdoor air pre-heating operation, before heating from the heat pump.

Alternately, the hot water coil (II) option extends the operating field of the unit to even colder climates. When necessary, it can also heat-up the external air before the treatment or integrate the capacity delivery from the heat pump. It can also fully substitute it in automatic mode, below an outside temperature value chosen by the user. For example, after having estimated the different supply costs of the energy sources in the individual application situations. In the event the heat pump is damaged, the hot water coil is automatically activated in emergency mode.

In very cold climates it is also necessary to foresee the 'Application for low outdoor temperature' option. The operation fields of the different heating options are shown separately.

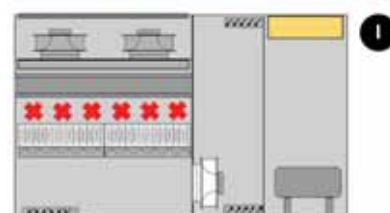

Exhaust air energy recovery

The air renewal in buildings is indispensable for checking the air quality and comfort. The movement and the treatment of the outdoor air generate added costs in the realisation of the system and energy consumption in its service life. For this reason the energy recovery devices on exhaust air are widely used. Local standards and provisions regulate the application.

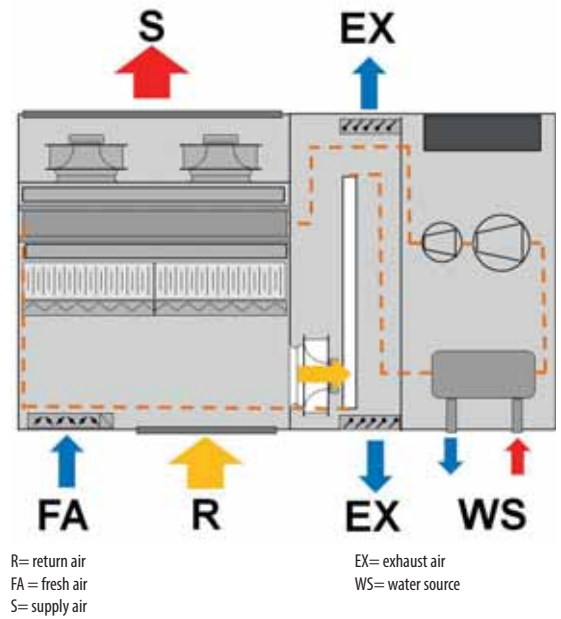

Thermodynamic recovery

The thermodynamic energy recovery uses the technology of the refrigeration circuit with direct expansion, without passive exchangers.

The flow of exhaust air is conveyed on an additional finned coil exchanger connected to the refrigeration circuit. This significantly reduces the heat exchange on the main source, and therefore the water consumption.

The benefits are:

- Increases the overall efficiency of the system, because it reduces the need for water from the source and therefore the pumping, disposal and thermal integration consumptions.
- Eliminates the main electric consumptions for ventilation of the passive recuperators that also greatly reduces the effective energy recovered
- Also efficient in the cooling operation, in particular in continental and moderate climates when the passive return of the recuperators delivered is almost nul due to the low temperature and enthalpy difference between outside and inside
- It keeps the unit compact and therefore it simplifies the positioning with respect to a static recovery.

Efficiency %	Air volume flow m ³ x s ⁻¹				
	0.55 to 1.39	> 1.39 to 2.78	> 2.78 to 6.94	> 6.94 to 13.89	> 13.89
Pressure Losses Pa					
< 2000		40	43	50	55
> 2000 to 4000	40	43	47	53	58
> 4000 to 6000	43	45	50	58	63
> 6000	45	50	55	63	68
Operating hours /ha					
< 2000		150	175	200	225
> 2000 to 4000	175	200	225	250	275
> 4000 to 6000	200	225	250	275	300
> 6000	225	250	275	300	325



Energy considerations

The physical principle of thermodynamic energy recovery differs from the principle that manages passive recuperators. Therefore, efficiency indicators differ as well:

- The performances of the passive recuperators, that are air-air heat exchangers, are measured by the efficiency of the heat exchange. Such values must then be combined with the performances of the refrigerant circuit to obtain the overall performance of the unit
- The performances of the heat pump are measured by the performance coefficient (COP). The contribution of the thermodynamic energy recovery is in this case already included in the overall performance of the unit that can thus be inserted in the foreseen calculations of the different procedures of energy certification, both compulsory and voluntary.



Example for a unit of 16.000 m³/h in commercial application in continental climate

Reliability and saving throughout the entire life-cycle

System simplification and increasing in reliability

The single block solution significantly reduces the initial system costs in respect of the traditional solutions based on the hydronic systems with separate production, for example by means of chillers and boilers, or on direct expansion systems with renewal air.

Most of the normal engineering activities are in fact created by Clivet **inside the unit**

- Component selection and dimensioning
- Water and mechanical connections
- Electric and control wiring
- Functional test

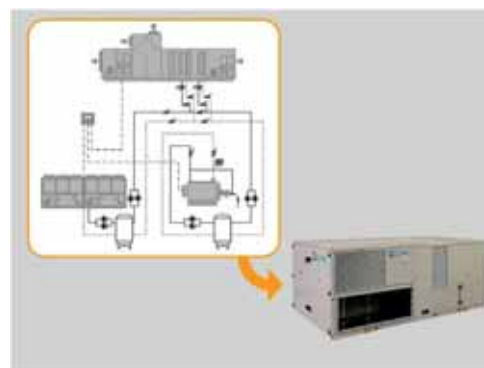

Only the connection of the air distribution channels, the unit power supply and the water feed water side (water loop) are provided by the Customer.

Energy transfer system saving

In modern large buildings is frequently simultaneous demand for heating and cooling by the different zones which are made up.

In the WLHP applications, the CLIVETPack² CRH-XHE2 units allow the energy transfer between zones with opposite needs. In many intended uses this condition occurs for most of the period of operation. The result is a large energy and cost savings compared to conventional systems.

For hygienic and legal reasons is also necessary to ensure the adequate air renewal. The CLIVETPack-XHE2 units also automatically perform this functionality, with the ability to enter only the renewal air actually required in all conditions of crowding lower than the project maximum values.

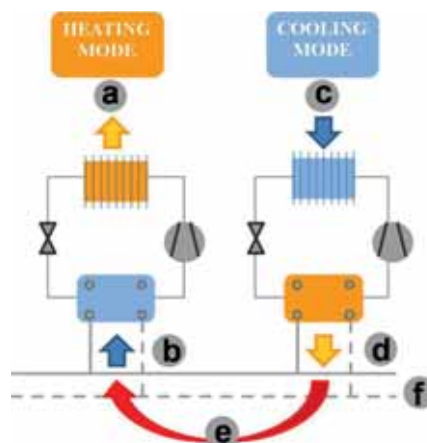

The WLHP system allows the transfer of thermal energy between units operating in an opposite mode: (a) Heating capacity released to the environment (b) Cooling capacity released to the loop (c) Cooling capacity released to the environment (d) Heating capacity released to the loop (e) Heat transfer (f) Water loop

Outdoor installation

The particularly compact dimensions allow its positioning outside on the roof, terrace or ground, even when the space is insufficient for a traditional rooftop unit.



Compact dimensions for indoor installation

The units can also be installed inside buildings or in technical rooms. It has however be ensured the aeraulic connection on the outdoor air intake and on the exhaust section when expected (CCK, CCKP configuration).

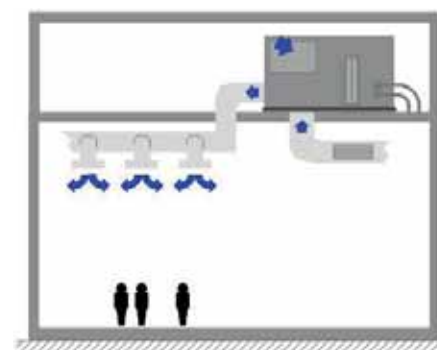

Ready to be connected to the water mains

The system components for the connection to the hydraulic supply circuit are **built-in the unit**. Thanks to their easily accessible location, the ordinary maintenance and installation are greatly simplified. The reliability increases because the tightness and functionality of the components are tested at the end of the production process.

Thanks to the specific plumbing assemblies available, the unit can be integrated perfectly into different types of hydraulic systems with loops or from groundwater, source water or disposable water. Each part has been carefully researched to guarantee the maximum operating efficiency and to protect the highly efficient water side exchanger from clogging.

The functions of the standard version (connections provided by the Customer)

The standard unit is complete with plate exchanger and safety device which checks the water flowrate.

Further components which are needed for connecting the hydraulic supply network are available as accessories.

STANDARD UNIT
(without hydraulic pipework arrangement)

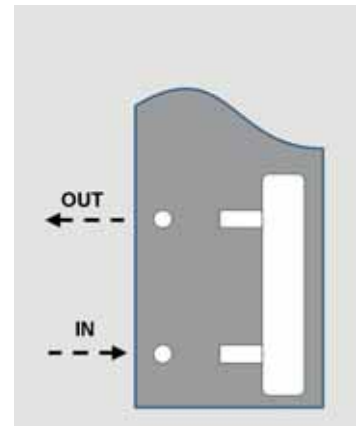

The reliability of the complete hydraulic pipeworks provided built-in

The unit can be supplied with hydraulic pipework arrangements built in with what it is necessary to properly start up and run the system at the different application types: loop with constant or variable flow rate, with aqueduct / disposable water system. The hydraulic pipework arrangements allow the unit interception by the system, the washing (flushing) of the system, the reduction of the consumption of water where the system is designed for this purpose.

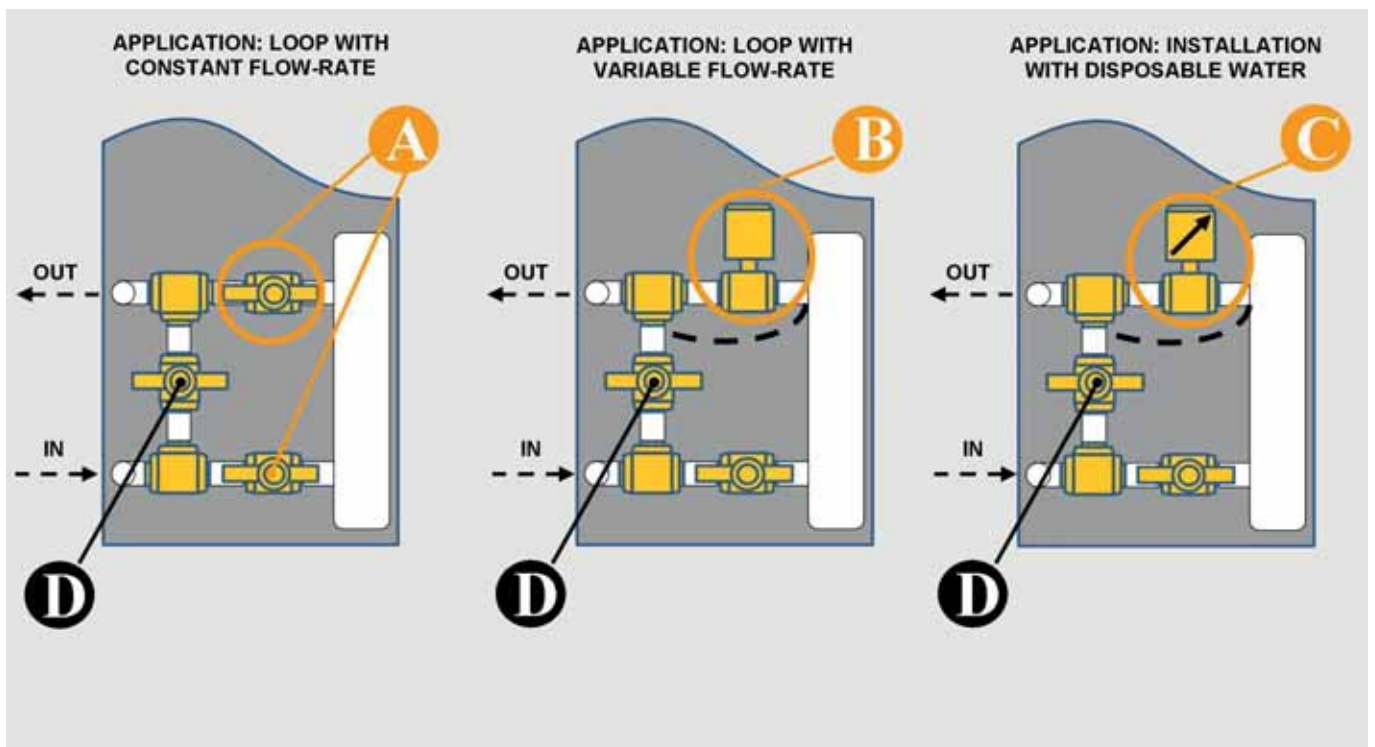

A - Manual shut-off valve
B - ON-OFF motorised 2-way valve

C - Modulating motorised 2-way valve
D - Washing bypass line

Operating completely automatic

The microprocessor control automatically manages operation according to the maximum efficiency criterion and includes many safety and alarm management functions.



Simple and intuitive user interface

An innovative graphic interface prepared for wall-installation (with 230V power supply and wiring at the customer's care) is supplied as standard, with the option to be removed from the support and connected on-board for maintenance operations.

Among the main functions it allows to:

- the temperature and humidity measurement is made by probes into the unit;
- daily/weekly start-up or power-off programming of the unit;
- operating mode (heat or cool) and/or set-point manual change ;
- alarm and unit status display;
- operating parameter management

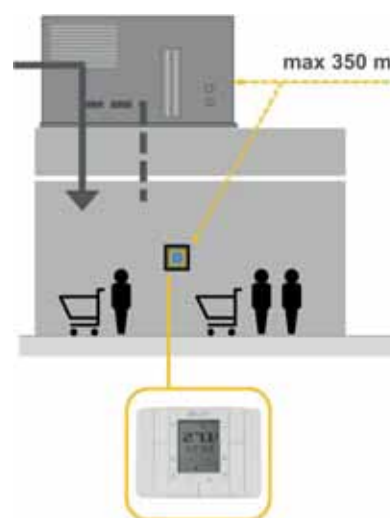

Remote system management

The unit can be remotely managed by:

- Remote control user interface, supplied standard
- Clivet Master System, device to manage a group made of max 8 units
- Potential-free contacts supplied as standard, to remotely control the main functions and to display alarms and operating status
- Different communication protocols to exchange information with the main supervision systems by serial line.



Composite panels with sandwich structure

The "sandwich" type panelling is lighter and sturdy. They reduce the thermal dispersions and therefore the energetic consumptions.

They are composed of a double steel wall that contains the insulating material, made of injected polyurethane. They are equipped with seal gasket for the whole length of the perimeter.

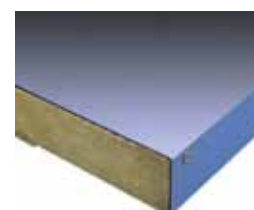

Easy access for maintenance

The internal components are positioned based on type, in a homogeneous area with easy and safe access, thanks to the hinges that support the larger sized doors to their adjustable hinges and to the device that blocks the access panel to the electrical control board.



How choosing the unit

The selection of the most appropriate size for an installation can be performed starting from the supply airflow value, established this value it is possible to choose among different available thermo-refrigerant treatments.

It is well-known that buildings built with modern technologies, that improve efficiency, have different needs than the previous buildings. In this case, the designer has to design systems with different potentialities.

Example: with airflow at 45000 m³/h, 6 possible cooling capacities are highlighted to do a different treatment, allowing to the designer to have a wide choice.

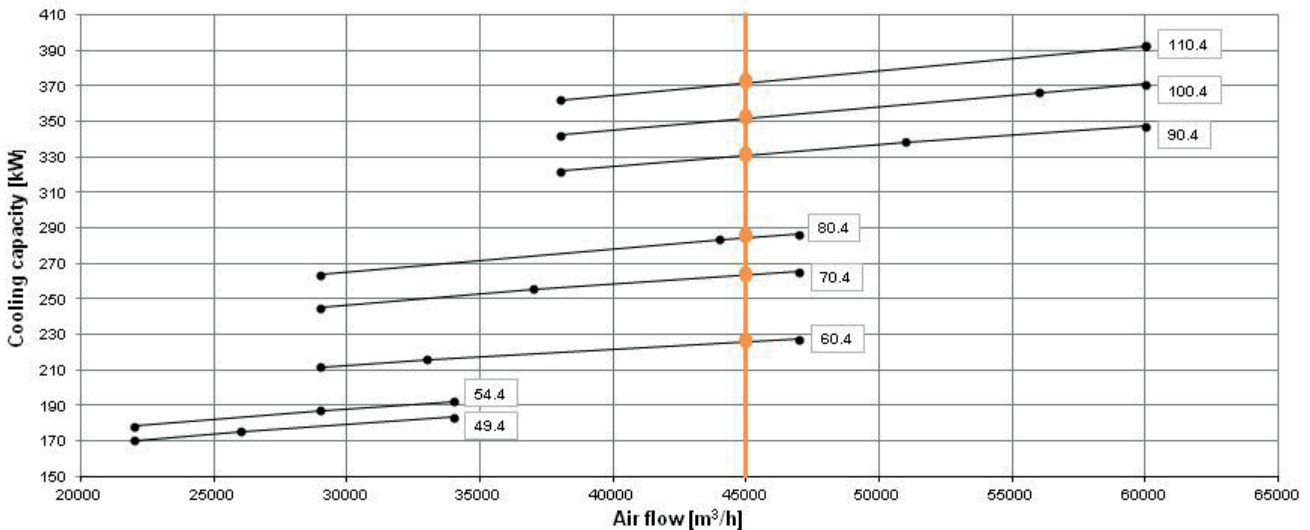

With same airflow is available a different thermo-refrigerant treatment depending on the selected size.

Unit configuration

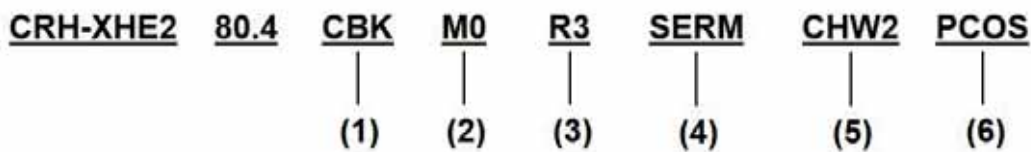

1. Configuration

- CAK configuration: single fan section for full recirculation
- CBK configuration: single fan section for recirculation and fresh air
- CCK double fan section for recirculation, fresh air, exhaust and FREE-COOLING
- CCKP double fan section with fresh air, exhaust and THOR thermodynamic recovery

2. Air supply

- M0 Horizontal supply
- M3 Downflow supply
- M5 Upflow supply

3. Air return

- R0 Horizontal return
- R3 Downflow return

4. Outdoor air damper

- Standard
- SERM - Outdoor air ON/OFF motorized damper (only CBK configuration)
- SFCM - Modulating motorized FREE-COOLING damper (only CBK configuration)
- SFCEM - Modulating motorized FREE-COOLING damper and min. outdoor air motorized ON/OFF damper (only CCK and CCKP configuration)

5. Auxiliary heating

- Standard
- EH - Electric elements
- CHW2 - 2row hot water coil
- CHWER - Energy recovery from the food refrigeration

6. Airflow

- Standard
- PCOS - Supply constant airflow
- PVAR - Variable airflow

Supply and return configurations

Functionalities			
Air supply and return	M0 - R0 Standard unit	M3 - R0 Option	M5 - R0 Option
	M0 - R3 Option	M3 - R3 Option	M5 - R3 Option

Filtration	G4	G4+F7	G4+FES H10
------------	-----------	--------------	-------------------

Auxiliary heating	Heat pump standard unit and electric heaters	Heat pump and hot water coil or energy recovery from the food refrigeration option
-------------------	--	--

Accessories separately supplied			
CLMX - Clivet Master System	AMRX - Rubber antivibration mounts	RCX - Roof curb	P-MATIC - Sistema di supervisione Clivet

Standard unit technical features - Configuration with single fan section for full recirculation (CAK) and for recirculation and fresh air (CBK)

Compressor

Hermetic orbiting scroll compressor complete with motor over-temperature and over-current devices and protection against excessive gas discharge temperature. Fitted on rubber antivibration mounts and complete with oil charge. The oil heater is automatically activated to prevent the oil from being diluted by the refrigerant when the compressor stops. The compressors are connected in TANDEM on a single refrigeration circuit and have a biphasic oil equalisation.

Structure

The support base is assembled with a painted galvanized steel frame. The internal structure is made of zinc - magnesium bent galvanized steel. The alloy Zn - Mg allows an excellent corrosion proofing thanks to the galvanic protection typical of the combination zinc - magnesium.

Panelling

Sandwich panels in the air treatment section with dual walls in steel sheet metal with polyurethane insulation (40 kg/m³), thickness of outer sheet metal 6/10 mm galvanized and painted using polyester powders colour RAL 9001, polyurethane thickness 40 mm with thermal conductivity coefficient 0.022W/mK, thickness of internal sheet metal 5/10 mm hot galvanized. The access door panels for the routine maintenance are provided with a PVC profile for thermal insulation and a EPDM rubber gasket that ensures the hermetic seal.

All panelling can easily be removed to allow complete accessibility to internal components.

Internal exchanger

Direct expansion finned coil exchanger made with copper pipes placed on staggered rows mechanically expanded to better adhere to the fin collar. The fins are made from aluminium with a corrugated surface and adequately distanced to ensure the maximum heat exchange efficiency.

External exchanger

Direct expansion exchanger, braze-welded AISI 316 stainless steel plates with large exchange surface and complete with external heat / anti-condensate insulation. complete with water side differential pressure switch and a water temperature control probe. Equipped with single water inlet and outlet.

Fan

Internal section

Plug fans without scroll with reverse blades driven by electronically-controlled "brushless" dc motors with direct coupling. No transmission sizing is needed. The motor is in compliance with ErP 2015 according to Regulation UE 640/2009. Class IE4.

Refrigeration circuit

Refrigeration circuit with:

- refrigerant charge
- liquid flow and moisture indicator
- safety high pressure switch
- filter dryer
- electronic expansion valve
- non-return valve
- 4-way reverse cycle valve
- liquid receiver
- high pressure safety valve
- low pressure safety valve

Filtration

Outdoor air inlet side and environment return side

Pleated filter for greater filtering surface, made of a galvanized sheet frame with a galvanized and electric-welded protective mesh, and regenerable filtering media made from polyester fibre sized with synthetic resins. G4 efficiency according to CEN-EN 779 standard (Eurovent classification EU4/5 - separation average 90.1% ASHRAE 52-76 Atm). Self-extinguishing type (flame resistant class 1 - DIN 53438).

Drain pan

Internal section

Inox steel AISI 304 condensate collection tray with anti-condensate insulation, welded, fitted with sleeve for the drain pipe.

Electrical panel

The electrical panel is situated inside the units and is accessed through a hinged door that is opened by a special key.

The capacity section includes:

- main door lock isolator switch
- compressor circuit breaker
- compressor power supply remote control switch
- fan motor thermal protections of internal section
- circuit breaker to protect auxiliary circuit

The microprocessor control section includes:

- compressor overload protection and timer
- potential-free contacts for remote ON-OFF, cumulative alarm, fire alarm inlet, fan status, compressor status, summer/winter mode

Remote control with user interface:

- intuitive graphical interface retro lighted
- daily/weekly start-up or power-off programming of the unit
- modification of the temperature and humidity set point
- unit On/Off and overload reset
- heating/cooling operating mode manual change
- display of operating status
- display of alarms and failure code
- display and modification of the operating parameters

Accessories

- Downflow supply
- Downflow return
- Upflow supply
- Two-rows hot water coil
- Modulating 3-way valve
- Modulating 2-way valve
- Energy recovery from food refrigeration
- Modulating 3-way valve for energy recovery from the food refrigeration
- Electric heaters
- Hot gas re-heating coil
- Immersed electrode humidifier
- Water to waste evaporating wet-deck humidifier
- Air quality probe for CO₂ rate check
- Air quality sensor for CO₂ and VOC rate check
- Outdoor air motorized ON/OFF damper (only for CBK configuration)
- Modulating motorized FREE-COOLING damper (only for CBK configuration)
- Modulating motorized FREE-COOLING damper and min. outdoor air motorized ON/OFF damper (only for CCK and CCKP configuration)
- Enthalpy FREE-COOLING (only for CCK and CCKP configuration)
- High static pressure fans
- High efficiency F7 air filter
- High efficiency H10 electronic filters
- Differential pressure switch for dirty air filters
- Serial communication module to Modbus supervisor
- Serial communication module to LonWorks supervisor
- Serial communication module for BACnet-IP supervisor
- Multi-function phase monitor
- Power factor correction capacitors (cosφ > 0.95)
- Constant supply airflow
- Variable airflow
- High and low pressure gauges
- Smoke detector
- Application for low outdoor temperature
- Rubber antivibration mounts (supplied separately)
- Clivet Master System (accessory separately supplied)
- Service interface (cable of 1,5 metres) (accessory separately supplied)
- Sandwich panels of the handling zone in M0 fire reaction class
- Antifreeze heater for exchanger protection, water side
- Hydraulic pipework arrangement for loop with constant flow-rate
- Hydraulic pipework arrangement for loop with variable flow-rate
- Hydraulic pipework arrangement for system with disposable water
- Set up for shipping via container
- Roof curb (accessory separately supplied)
- Steel mesh strainer water side (accessory separately supplied)

All the handling coils can be covered with aluminium - Fin Guard - copper/copper

Test

Unit manufactured to ISO 9001 standard and commissioned upon production completion.

Configuration with double fan section for recirculation, fresh air, exhaust and FREE-COOLING (CCK)

Technical features as the configuration with single fan section for full recirculation (CAK) and single fan section for recirculation and fresh air (CBK) and moreover:

- **Modulating motorized outdoor air damper for renewal and e FREE-COOLING**
- **Exhaust fan section**

Plug fans without scroll with reverse blades driven by electronically-controlled "brushless" DC motors with direct coupling. No drive sizing is required.

Configuration with double fan section for recirculation, fresh air, exhaust, THOR thermodynamic recovery (CCKP)

Technical features like the configuration with recirculation, renewal and exhaust air (CCK) and also:

- **Exchanger for thermodynamic recovery - THOR**

The energy content of the exhaust air is recovered by a dedicated exchanger, as integral part of the refrigeration circuit. It is a direct expansion finned coil exchanger made with copper pipes placed on staggered rows mechanically expanded to better adhere to the fin collar. The fins are made from aluminium with a corrugated surface and adequately distanced to ensure the maximum heat exchange efficiency.

STANDARD AIRFLOW

General technical data

Size				49.4	54.4	60.4	70.4	80.4	90.4	100.4	110.4
Cooling											
Cooling capacity	CAK	1	kW	175,0	187,0	215,6	255,4	283,2	338,4	366,4	392,5
Sensible capacity		1	kW	123,8	133,5	142,6	162,6	186,2	239,2	258,2	277,0
Compressor power input		1	kW	30,8	33,1	39,9	45,4	52,4	61,7	66,3	72,1
EER		1	-	5,68	5,65	5,40	5,63	5,40	5,48	5,53	5,44
SEER		9		6,29	5,07	5,61	6,07	5,47	5,80	5,17	5,31
ηsc		9	%	243,7	195,0	216,6	234,9	210,7	224,0	198,9	204,5
Water flow-rate			l/s	9,8	10,5	12,2	14,4	16,0	19,1	20,7	22,2
Pressure drop water side			-	33,64	38,23	43,77	38,48	47,34	52,21	40,98	39,73
Cooling capacity		CBK / CCK	2	kW	183,1	195,6	225,8	267,7	296,7	354,5	383,9
Sensible capacity	2		kW	127,0	136,7	146,7	167,6	191,7	246,6	266,0	284,3
Compressor power input	2		kW	30,9	33,3	40,1	45,6	52,7	62,1	66,8	72,7
EER	2		-	5,93	5,87	5,63	5,87	5,63	5,71	5,75	5,66
Water flow-rate			l/s	10,2	10,9	12,7	14,8	16,7	19,9	21,5	23,1
Pressure drop water side			-	36,26	41,2	47,17	41,57	51,08	56,37	44,28	42,99
Cooling capacity	CCKP	3	kW	183,1	195,6	225,8	267,7	296,7	354,5	383,9	411,6
Sensible capacity		3	kW	127,0	136,7	146,7	167,6	191,7	246,6	266,0	284,3
Compressor power input		3	kW	30,9	33,3	40,1	45,6	52,7	62,1	66,8	72,7
EER		3	-	5,93	5,87	5,63	5,87	5,63	5,71	5,75	5,66
Water flow-rate			l/s	9,3	9,9	11,5	13,7	15,2	18,1	19,6	21,1
Pressure drop water side			-	30,14	33,96	39,36	35,04	42,58	47,15	36,98	35,94
Heating											
Heating capacity	CAK	1	kW	186,3	200,2	223,1	259,3	297,2	359,4	386,0	422,5
Compressor power input		1	kW	38,0	41,0	48,1	53,2	60,5	66,8	75,0	82,6
COP		1	-	4,90	4,88	4,64	4,87	4,91	5,38	5,15	5,12
SCOP		9		4,92	4,52	4,04	4,73	4,31	4,54	4,55	4,60
ηsh		9	%	194	178	159	186	169	179	179	181
Heating capacity	CBK	2	kW	191,8	206,1	230,5	267,5	305,9	367,3	396,7	435,5
Compressor power input		2	kW	35,2	37,9	44,5	49,2	55,9	62,5	69,3	76,2
COP		2	-	5,45	5,44	5,18	5,44	5,47	5,88	5,72	5,72
Heating capacity	CCK	3	kW	191,8	206,1	230,5	267,5	305,9	367,3	396,7	435,5
Compressor power input		3	kW	35,2	37,9	44,5	49,2	55,9	62,5	69,3	76,2
COP		3	-	5,45	5,44	5,18	5,44	5,47	5,88	5,72	5,72
Heating capacity	CCKP	3	kW	191,8	206,1	230,5	267,5	305,9	367,3	396,7	435,5
Compressor power input		3	kW	35,2	37,9	44,5	49,2	55,9	62,5	69,3	76,2
COP		3	kW	5,45	5,44	5,18	5,44	5,47	5,88	5,72	5,72

The Product is compliant with the Erp (Energy Related Products) European Directive. It includes the Commission delegated Regulation (EU) No 2016/2281, also known as Ecodesign Lot21.

Contains fluorinated greenhouse gases (GWP 2087,5)

Performances in cooling: Indoor air temp. 27°C/19°C W.B. Outdoor air 35°C D.B./24°C W.B. EER referred only to compressors, water entering/leaving temperature 30/35°C

Performance in Heating: Indoor air temp. 20°C D.B./12°C W.B. Outdoor air 7°C/6°C W.B. COP referred only to compressors, water entering/leaving temperature 15/10°C

1. Performance refers to operation at full re-circulation
2. Performance with 30% of outdoor air
3. Performance with 30% of outdoor air including the energy recovery on the exhaust air
4. SCROLL = scroll compressor
5. Indicative values for standard units (CCKP configuration) with possible +/-10% variation. The actual data are indicated on the label of the unit
6. RAD = radial fan electronically controlled
7. Net outside static pressure to win the outlet and intake onboard pressure drops
8. Configuration with double fan section for recirculation, fresh air, exhaust, thermodynamic recovery (CCK) and configuration with double fan section with fresh air and THOR thermodynamic recovery (CCKP)
9. Data calculated in accordance with EN 14825: 2018

Size				49.4	54.4	60.4	70.4	80.4	90.4	100.4	110.4
Compressor											
Type of compressors		4		Scroll	Scroll	Scroll	Scroll	Scroll	Scroll	Scroll	Scroll
No. of compressors			Nr	4	4	4	4	4	4	4	4
Std Capacity control steps			Nr	6	6	4	6	6	6	6	6
Refrigerant charge (C1)	CCKP	5	Kg	32	32	38	38	42	67	71	73
Refrigerant charge (C2)		5	Kg	28	32	38	38	42	67	71	73
Refrigeration circuits			Nr	2	2	2	2	2	2	2	2
Air Handling Section Fans (Supply)											
Type of supply fan		6		RAD	RAD	RAD	RAD	RAD	RAD	RAD	RAD
No. of supply fans			Nr	3	3	4	4	4	6	6	6
Fan diameter			mm	560	560	560	560	560	560	560	560
Supply airflow			l/s	7222	8056	9167	10278	12222	14167	15556	16667
Supply airflow			m ³ /h	26000	29000	33000	37000	44000	51000	56000	60000
Installed unit power			kW	2,9	2,9	2,9	2,9	2,9	2,9	2,9	2,9
Max. static pressure supply fan		7	Pa	630	540	660	570	360	620	540	460
High static pressure air handling section fans (OPTIONAL)											
Type of supply fan				RAD	RAD	RAD	RAD	RAD	RAD	RAD	RAD
Number of supply fans			Nr	3	3	4	4	4	6	6	6
Fan diameter			mm	500	500	500	500	500	500	500	500
Supply airflow			l/s	7222	8056	9167	10278	12222	14167	15556	16667
Supply airflow			m ³ /h	26000	29000	33000	37000	44000	51000	56000	60000
Installed unit power			kW	5,5	5,5	5,5	5,5	5,5	5,5	5,5	5,5
Max. static pressure supply fan		7	Pa	1140	1080	1140	1140	900	1140	1140	1020
Fans (Exhaust) (only CCK, CCKP-THOR configuration)											
Type of fans		6		RAD	RAD	RAD	RAD	RAD	RAD	RAD	RAD
No. of fans		8		2	2	2	2	2	2	2	2
Fan diameter		8	mm	500	500	630	630	630	630	630	630
Installed unit power		8	kW	2,6	2,6	2,7	2,7	2,7	2,7	2,7	2,7
Connections											
Condensate drain		-	mm	30	30	30	30	30	30	30	30
Power supply											
Standard power supply		-	V	400/3/50	400/3/50	400/3/50	400/3/50	400/3/50	400/3/50	400/3/50	400/3/50

The Product is compliant with the Erp (Energy Related Products) European Directive. It includes the Commission delegated Regulation (EU) No 2016/2281, also known as Ecodesign Lot21.

Contains fluorinated greenhouse gases (GWP 2087,5)

Performances in cooling: Indoor air temp. 27°C/19°C W.B. Outdoor air 35°C D.B./24°C W.B. EER referred only to compressors, water entering/leaving temperature 30/35°C

Performance in Heating: Indoor air temp. 20°C D.B./12°C W.B. Outdoor air 7°C/6°C W.B. COP referred only to compressors, water entering/leaving temperature 15/10°C

1. Performance refers to operation at full re-circulation
2. Performance with 30% of outdoor air
3. Performance with 30% of outdoor air including the energy recovery on the exhaust air
4. SCROLL = scroll compressor
5. Indicative values for standard units (CCKP configuration) with possible +/-10% variation. The actual data are indicated on the label of the unit
6. RAD = radial fan electronically controlled
7. Net outside static pressure to win the outlet and intake onboard pressure drops
8. Configuration with double fan section for recirculation, fresh air, exhaust, thermodynamic recovery (CCK) and configuration with double fan section with fresh air and THOR thermodynamic recovery (CCKP)
9. Data calculated in accordance with EN 14825:2018

Sound levels

Size	Sound power level (dB)								Sound power level	Sound pressure level
	Octave band (Hz)									
	63	125	250	500	1000	2000	4000	8000	dB(A)	dB(A)
49.4	74	81	80	82	82	80	77	77	87	67
54.4	76	83	83	84	84	82	79	80	88	69
60.4	74	81	80	82	82	81	78	77	88	67
70.4	76	84	83	85	84	85	79	80	90	70
80.4	78	85	85	86	87	87	82	81	92	72
90.4	76	83	83	85	86	86	81	79	92	71
100.4	78	85	85	87	88	88	82	81	93	73
110.4	80	87	86	88	89	89	84	83	94	74

The sound levels are referred to unit operating at full load in nominal conditions. The sound pressure level is referred to a distance of 1 m. from the ducted unit surface operating in free field conditions. External static pressure 50 Pa. (standard UNI EN ISO 9614-2)
Please note that when the unit is installed in conditions different from nominal test conditions (e.g. near walls or obstacles in general), the sound levels may undergo substantial variations.

Electrical data

Configuration: with direct ductable return (CAK) and outdoor air recirculation (CBK)

Size		49.4	54.4	60.4	70.4	80.4	90.4	100.4	110.4	
F.L.A. - Full load current at max admissible conditions										
F.L.A. - Compressor 1	A	15,4	23,0	30,9	30,9	30,9	30,9	36,5	44,6	
F.L.A. - Compressor 2	A	30,9	30,9	30,9	36,5	44,6	59,3	59,3	59,3	
F.L.A. - Compressor 3	A	23,0	23,0	30,9	30,9	30,9	30,9	36,5	44,6	
F.L.A. - Compressor 4	A	30,9	30,9	30,9	36,5	44,6	59,3	59,3	59,3	
F.L.A. - Single supply fan	A	4,4	4,4	4,4	4,4	4,4	4,4	4,4	4,4	
F.L.A. - Total	1 A	114,3	121,9	142,1	153,3	169,5	207,8	218,9	235,2	
L.R.A. - Locked rotor amperes										
L.R.A. - Compressor 1	A	95,0	118,0	174,0	174,0	174,0	174,0	225,0	272,0	
L.R.A. - Compressor 2	A	174,0	174,0	174,0	225,0	272,0	310,0	310,0	310,0	
L.R.A. - Compressor 3	A	118,0	118,0	174,0	174,0	174,0	174,0	225,0	272,0	
L.R.A. - Compressor 4	A	174,0	174,0	174,0	225,0	272,0	310,0	310,0	310,0	
F.L.I. - Full load power input at max admissible conditions										
F.L.I. - Compressor 1	kW	9,1	13,1	17,0	17,0	17,0	17,0	22,6	27,6	
F.L.I. - Compressor 2	kW	17,0	17,0	17,0	22,6	27,6	36,1	36,1	36,1	
F.L.I. - Compressor 3	kW	13,1	13,1	17,0	17,0	17,0	17,0	22,6	27,6	
F.L.I. - Compressor 4	kW	17,0	17,0	17,0	22,6	27,6	36,1	36,1	36,1	
F.L.I. - Single supply fan	kW	2,9	2,9	2,9	2,9	2,9	2,9	2,9	2,9	
F.L.I. - Total	2 kW	65,3	69,2	79,9	91,2	101,2	124,0	135,3	145,3	
M.I.C. Maximum inrush current										
M.I.C. - Value	A	257,4	265,0	285,2	341,8	396,9	458,5	469,6	485,9	

Configuration: with recirculation, exhaust and fresh air (CCK) and mixing chamber with recovery exchanger (CCKP)

Size		49.4	54.4	60.4	70.4	80.4	90.4	100.4	110.4	
F.L.A. - Full load current at max admissible conditions										
F.L.A. - Compressor 1	A	15,4	23,0	30,9	30,9	30,9	30,9	36,5	44,6	
F.L.A. - Compressor 2	A	30,9	30,9	30,9	36,5	44,6	59,3	59,3	59,3	
F.L.A. - Compressor 3	A	23,0	23,0	30,9	30,9	30,9	30,9	36,5	44,6	
F.L.A. - Compressor 4	A	30,9	30,9	30,9	36,5	44,6	59,3	59,3	59,3	
F.L.A. - Single supply fan	A	4,4	4,4	4,4	4,4	4,4	4,4	4,4	4,4	
F.L.A. - Single exhaust fan	A	4,0	4,0	4,3	4,3	4,3	4,3	4,3	4,3	
F.L.A. - Total	1 A	122,2	129,8	150,7	161,9	178,1	216,4	227,5	243,8	
L.R.A. - Locked rotor amperes										
L.R.A. - Compressor 1	A	95,0	118,0	174,0	174,0	174,0	174,0	225,0	272,0	
L.R.A. - Compressor 2	A	174,0	174,0	174,0	225,0	272,0	310,0	310,0	310,0	
L.R.A. - Compressor 3	A	118,0	118,0	174,0	174,0	174,0	174,0	225,0	272,0	
L.R.A. - Compressor 4	A	174,0	174,0	174,0	225,0	272,0	310,0	310,0	310,0	
F.L.I. - Full load power input at max admissible conditions										
F.L.I. - Compressor 1	kW	9,1	13,1	17,0	17,0	17,0	17,0	22,6	27,6	
F.L.I. - Compressor 2	kW	17,0	17,0	17,0	22,6	27,6	36,1	36,1	36,1	
F.L.I. - Compressor 3	kW	13,1	13,1	17,0	17,0	17,0	17,0	22,6	27,6	
F.L.I. - Compressor 4	kW	17,0	17,0	17,0	22,6	27,6	36,1	36,1	36,1	
F.L.I. - Single supply fan	kW	2,9	2,9	2,9	2,9	2,9	2,9	2,9	2,9	
F.L.I. - Single exhaust fan	kW	2,6	2,6	2,8	2,8	2,8	2,8	2,8	2,8	
F.L.I. - Totale	2 kW	70,4	74,4	85,4	96,7	106,7	129,5	140,8	150,8	
M.I.C. Maximum inrush current										
M.I.C. - Valore	A	265,3	272,9	293,8	350,4	405,5	467,1	478,2	494,5	

Data refer to standard units. Power supply: 400/3/50 Hz. Voltage variation: max. +/-10% Voltage unbalance between phases: max 2 %

- Values not including the accessories. To obtain the value of F.L.A. including accessories, add to the total F.L.A. value that of any accessories (see electrical data of accessories)
- Values not including the accessories. To obtain the value of F.L.I. including accessories, add to the total F.L.I. value that of any accessories (see electrical data of accessories)

Electrical input of optional components

To obtain the electrical input of the unit including accessories, add the standard data in Electrical Data table to those for the selected accessories.

SIZES			49.4	54.4	60.4	70.4	80.4	90.4	100.4	110.4
F.L.A. Absorbed current										
F.L.A. EH20 - 24 kW electric elements		A	34,7	34,7	34,7	34,7	34,7	34,7	34,7	34,7
F.L.A. EH24 - 36 kW electric elements		A	52,0	52,0	52,0	52,0	52,0	52,0	52,0	52,0
F.L.A. EH28 - 48 kW electric elements		A	69,4	69,4	69,4	69,4	69,4	69,4	69,4	69,4
F.L.A. HSE8 - Immersed electrodes steam humidifier of 8 kg/h		A	8,7	8,7	8,7	8,7	8,7	8,7	8,7	8,7
F.L.A. HSE9 - Immersed electrodes steam humidifier of 15 kg/h		A	16,2	16,2	16,2	16,2	16,2	16,2	16,2	16,2
F.L.A. LTEMP1 - Application for low outdoor temperature		A	1,5	1,5	1,5	1,5	1,5	1,5	1,5	1,5
F.L.A. VENH - High static pressure fans	1	A	12,0	12,0	16,0	16,0	16,0	24,0	24,0	24,0
F.L.I. Power input										
F.L.I. EH20 - 24 kW electric elements		kW	24,0	24,0	24,0	24,0	24,0	24,0	24,0	24,0
F.L.I. EH24 - 36 kW electric elements		kW	36,0	36,0	36,0	36,0	36,0	36,0	36,0	36,0
F.L.I. EH28 - 48 kW electric elements		kW	48,0	48,0	48,0	48,0	48,0	48,0	48,0	48,0
F.L.I. HSE8 - Immersed electrodes steam humidifier of 8 kg/h		kW	6,0	6,0	6,0	6,0	6,0	6,0	6,0	6,0
F.L.I. HSE9 - Immersed electrodes steam humidifier of 15 kg/h		kW	11,3	11,3	11,3	11,3	11,3	11,3	11,3	11,3
F.L.I. LTEMP1 - Application for low outdoor temperature		kW	0,7	0,7	0,7	0,7	0,7	0,7	0,7	0,7
F.L.I. VENH - High static pressure fans	1	kW	7,8	7,8	10,4	10,4	10,4	15,6	15,6	15,6

1. The absorption value that needs to be added on takes into account the difference between the optional high head fans and the standard fans.

Pressure drops of optional components

The value of static pressure available on the supply and return duct is obtained by subtracting from the available net maximum pressure (see general table of technical data) the pressure drops of any accessories.

SIZES			49.4	54.4	60.4	70.4	80.4	90.4	100.4	110.4
CHW2 - Two-row hot water coil		Pa	35	43	31	39	52	46	54	61
CPHG - Hot gas re-heating coil		Pa	18	20	19	21	25	23	26	28
CHWER - Energy recovery from the food refrigeration		Pa	54	65	48	60	80	68	80	89
HWS - Steam humidifier		Pa	23	25	24	26	30	28	31	33
F7 - F7 high efficiency air filter	1	Pa	130	138	128	137	152	151	162	172
FES - High efficiency electronic filters		Pa	61	70	56	65	82	81	92	101

The values shown are to be considered approximate for units operating power in normal use with standard air flow rate.

1. Pressure drops with filters with average dirtiness

Operating range (Cooling)

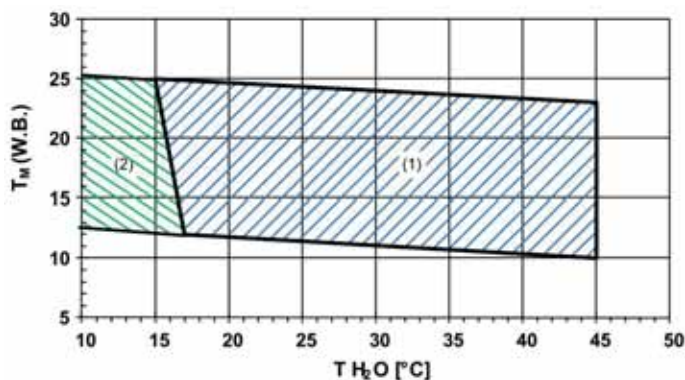

The limits are meant as an indication and they have been calculated by considering:

- general and non specific sizes,
- standard airflow,
- operating at full load
- non-critical positioning and correct use of the unit,
- difference between inlet / outlet water temperature = 5°C

To verify the operating range of the operating units with percentages of outdoor air, always calculate the T_m mixing temperature at the internal heat exchanger input.

T_m = entering internal exchanger air temperature
Attention! Temperature measured with wet bulb (W.B.=WETBULB)

TH20 = water loop temperature (°C) (plate exchanger input)

1. Standard operating range
2. Unit operating range with pumping unit for installation with disposable water (optional)

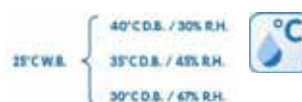

Operating range (Heating)

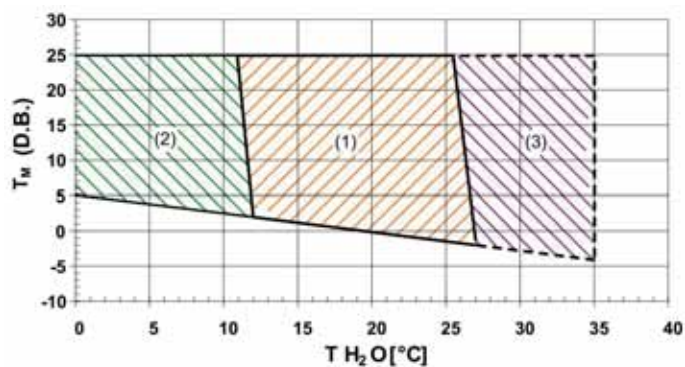

The limits are meant as an indication and they have been calculated by considering:

- general and non specific sizes,
- standard airflow,
- non-critical positioning and correct use of the unit,
- operating at full load
- difference between inlet / outlet water temperature = 5°C

To verify the operating range of the operating units with percentages of outdoor air, always calculate the T_m mixing temperature at the internal heat exchanger input.

T_m = entering internal exchanger air temperature
Attention! Temperature measured with dry bulb (D.B.=DRY BULB)

TH20 = water loop temperature (°C) (plate exchanger input)

1. Operating range at full load
2. Operating range for water glycol system (to prevent frost)
1. + 3. Unit operating range with pumping unit for installation with disposable water (optional) with modulating valve, also for loop high temperatures

Accessories

EH - Electric elements

This option is suggested for cold climates, allows the integration of heating capacity from the heat pump. The electrical heaters are placed before the treatment coil and perform the air preheating function, extending the operating range of the unit and helping quickly to reach the comfort in the room. Ideal for climate areas in applications with low outside temperature where it is required to active the heaters only for short time in the year.

In these cases the resulting system simplification compensates the energy costs. The fins are made of aluminum, of suitable dimension to ensure high efficiency and maintain low power density on the surfaces to limit overheating.

The low temperature of the heating elements increases the lifespan and limits the effect of air ionization.

The electrical heating elements are managed by the controller with two power steps..



Matching of the electric elements

Size	49.4	54.4	60.4	70.4	80.4	90.4	100.4	110.4
24 kW	√	√	√	√	√	√	√	√
36 kW	√	√	√	√	√	√	√	√
48 kW	√	√	√	√	√	√	√	√



This option involves variation of the main electrical data of the unit.



'Electric elements', '2-row hot water coil' and 'Energy recovery from food refrigeration' cannot be assembled simultaneously.

Operating range extension with electric heaters

SIZES	Airflow [m3/h]	POWER ELECTRIC HEATERS / DELTA T [°C]		
		24kW	36kW	48kW
49.4	26000	2.7	4.1	5.5
54.4	29000	2.5	3.7	4.9
60.4	33000	2.2	3.2	4.3
70.4	37000	1.9	2.9	3.8
80.4	44000	1.6	2.4	3.2
90.4	52000	1.4	2.1	2.7
100.4	56000	1.3	1.9	2.5
110.4	60000	1.2	1.8	2.4

The minimum operating temperature of the heat pump with electric heater change and depends on the series and the power of the electric heater. The minimum temperature is easily to reckon subtrahend the DT value (table following below) to the entering internal exchanger air temperature T_M (D.M.) for standard unit, at the desired conditions.

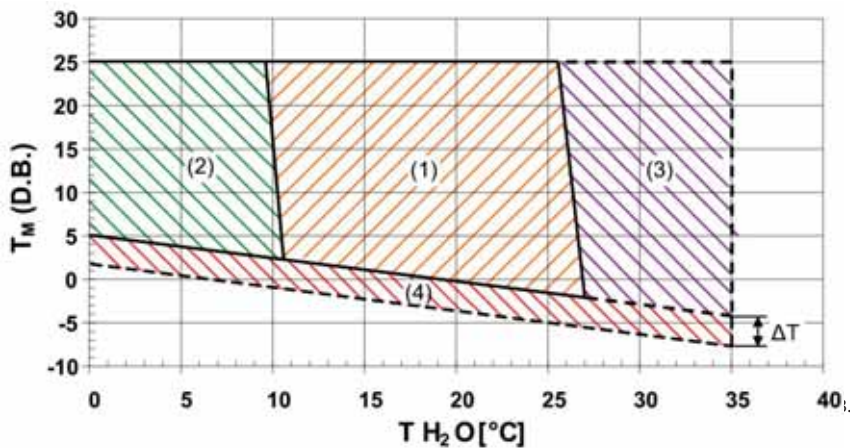

The limits are meant as an indication and they have been calculated by considering:

- general and non specific sizes,
 - standard airflow,
 - non-critical positioning of the unit and correct operating and maintenance of the unit,
 - operating at full load
- to verify the operating range of the operating units with percentages of outdoor air, always calculate the T_m mixing temperature at the internal heat exchanger input.

T_m = internal exchanger entering air temperature dry bulb measured temperature (D.B.=DRY BULB)

Text = inlet air temperature in the external exchanger temperature measured with wet bulb (W.B.=WET BULB)

1. Operating range of the standard unit
2. Operating range with glycolated water (to prevent freezing)
Operating range of the unit equipped with hydraulic pipework arrangement for a system with disposable water (optional).
4. Extension of the operating range with preheating heating elements. To obtain the lower limit curve, consider as the temperature difference (delta T) the value shown in the "Operating range extension with electric heaters" table.

CHW2 - Two-row hot water coil

Option indicated for very cold climates, as it allows to heat up the area served. The exchanger comes with a thermostat for the antifreeze function, which is always active even when the unit is in stand-by, as long as it is operated electrically. If required, force the opening of the valve to the maximum value allowed to allow the air to pass through the exchanger and prevent frost from forming.

The hot water coil allows the integration of the heat pump capacity, as being placed before the treating coil, it pre-heats the air, extending the operation limits of the unit. If the water coil operates as integration to the heat pump, the control logic reduces the potential at a pre-determined limit value, which prevents to make the compressors work at too high condensation temperatures. On the other hand, if the water coil is used as main resource (i.e. availability of the compressors) the potential supplied will be the highest.

In the event laws or local standards encourage the use of the district heating, and so the use of hot water coil heating with the obligation to recover the energy contained inside the exhaust air flow, a turning point can be set, that is an outside air temperature, below which the unit uses the water coil as main resource and operates also as thermodynamic recuperator at very high efficiency, using the nominal capacity of the heat pump circuit only partially.

With the option is available a potential-free contact for the water circulator start-up (provided by the Installer).

Hot water coil pressure drops: AIR side

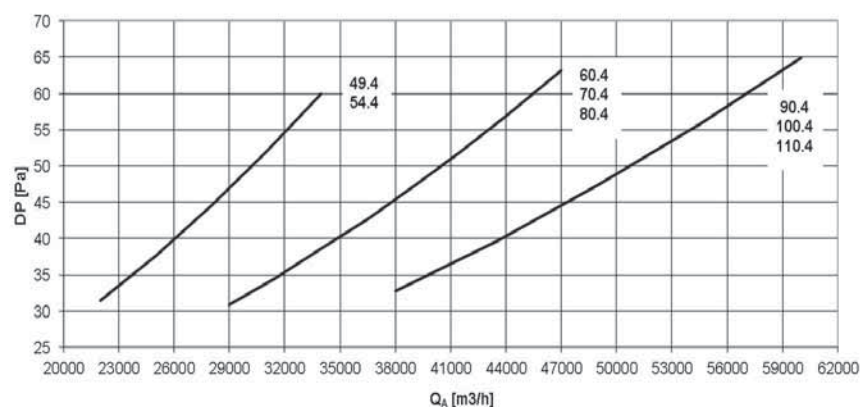

The air side pressure drops are relative to the medium air temperature of 20°C and are to be added to the pressure drops due to ducts, terminal devices and any other component that causes a drop in working discharge head.

QA [m3/h] = airflow
DP[Pa] = pressure drops

Hot water coil pressure drops: WATER side

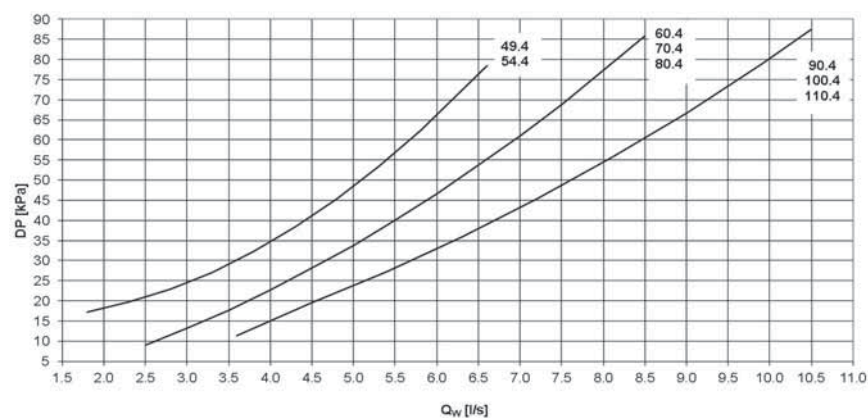

Pressure drops on the water side are calculated considering an average water temperature of 65°C

QW [l/s] = water flow-rate
DP[kPa] = pressure drops

$$QW [l/s] = P / (4.186 \times DT)$$

P = Water coil heating capacity in KW
DT = Temperature difference between inlet / outlet water

This option reduces the available static pressure (supply air side).



The component requires connection to the hot water plumbing system (to be provided for by the client).



'2 range hot water coil' and 'Electric elements' cannot be assembled simultaneously.

Performances of hot water coil (two-row)

SIZE		Ti/To (°C)												
		60 / 40	70 / 55	70 / 60	80 / 65	60 / 40	70 / 55	70 / 60	80 / 65	60 / 40	70 / 55	70 / 60	80 / 65	
		kWt	kWt	kWt	kWt	kWt	kWt	kWt	kWt	kWt	kWt	kWt	kWt	
49.4 54.4	Qo (m3 / h)	22000				28000				34000				
	Qo (l / s)	6111				7777				9444				
	TM (°C)	5	182,0	240,1	253,2	283,9	212,2	281,4	297,3	333,2	239,7	318,5	337,0	377,5
		10	159,3	217,5	230,4	261,1	185,9	254,9	270,7	306,3	209,7	288,6	306,9	347,0
		14	141,4	199,5	212,5	243,0	165,0	233,9	249,6	285,1	186,0	264,7	283,0	323,0
		16	132,5	190,5	203,5	234,0	154,5	223,4	239,1	274,5	174,2	252,9	271,1	311,0
		18	123,5	181,7	194,6	225,0	144,0	213,0	228,7	264,0	162,3	241,1	259,3	299,2
20	114,6	172,9	185,7	216,1	133,5	202,6	218,3	253,6	150,4	229,3	247,5	287,3		
60.4 70.4 80.4	Qo (m3 / h)	29000				38000				47000				
	Qo (l / s)	8055				10555				13055				
	TM (°C)	5	235,7	312,8	330,4	370,3	280,1	373,4	395,4	442,5	319,3	427,2	453,1	506,7
		10	206,3	283,0	300,7	340,4	245,1	338,0	359,9	406,9	279,2	386,8	412,5	465,9
		14	182,8	259,7	277,0	316,7	217,0	310,0	331,7	378,6	247,3	354,7	380,3	433,6
		16	171,1	247,8	265,3	304,9	203,1	295,9	317,5	364,5	231,2	338,7	364,0	417,5
		18	159,5	236,4	253,8	293,2	189,1	282,1	303,7	350,5	215,2	322,8	348,1	401,4
20	147,9	224,8	242,2	281,4	175,1	268,3	289,9	336,6	199,2	306,7	332,3	385,5		
90.4 100.4 110.4	Qo (m3 / h)	38000				49000				60000				
	Qo (l / s)	10555				13611				16666				
	TM (°C)	5	313,4	412,6	434,6	487,8	369,1	487,4	514,4	576,9	418,3	554,3	585,8	656,5
		10	275,1	373,9	395,6	448,6	323,3	441,7	468,5	530,6	366,8	502,4	533,6	603,9
		14	244,5	343,2	364,8	417,3	287,0	405,5	432,1	493,6	325,3	461,1	492,2	561,8
		16	229,0	327,9	349,6	402,0	269,1	387,4	414,0	475,4	304,8	440,6	471,6	541,2
		18	213,7	312,7	334,3	386,7	251,1	369,5	396,0	457,4	284,0	420,1	451,1	520,6
20	198,4	297,6	319,2	371,4	232,9	351,5	378,0	439,3	263,6	399,7	430,7	500,1		

TM = air inlet temperature of water coil (°C)

Ti/To = water temperature inlet/outlet (°C)

Qo = air flow (l/s and m3/h)

kWt = Provided heating capacity (kW)

Thermal yields referred to the max. water coil capacity. The thermo regulator cokes the 3-way modulating valve limiting the inlet air temperature at desired values.

3WVM - Modulating 3-way valve

To be combined with hot water coil (optional). It is managed by the built-in microprocessor via a 0-10V signal and allows the fully automatic control of the water coil. The valve with modulating actuator is provided already assembled and wired built-in the unit.

Valve pressure drops

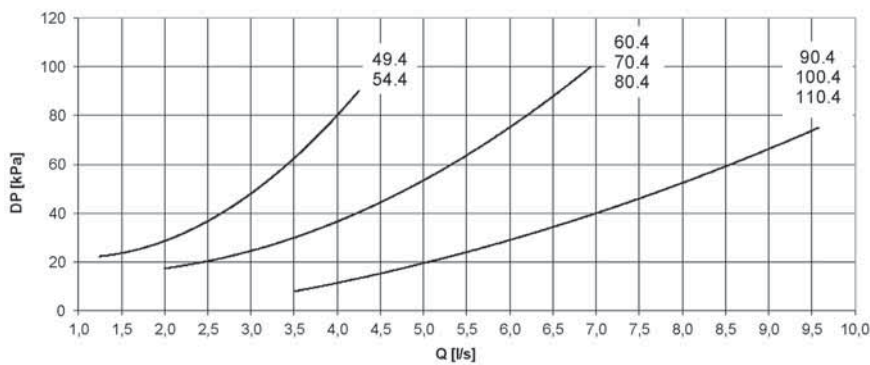

Q [l/s] = water flow-rate
DP [kPa] = pressure drops



This accessory has to be coupled to the "CHW2 - Two-row hot water coil" option

CHWER - Energy recovery from food refrigeration

This option makes it possible, during the winter season, to recover the heating energy produced by food storage in supermarkets, hypermarkets or food factories. It is a technical solution that recovers a significant heating resource, which is otherwise normally released outdoors.

The unit logic assigns a priority value to this function based on the heating availability of the resource, and integrates the overall output of the unit.

The option is comprised of a water exchanger, which is automatically controlled by a dedicated valve. With electrically powered units, the frost function is enabled, which forces the valve open when required.

Hot water coil pressure drops: AIR side

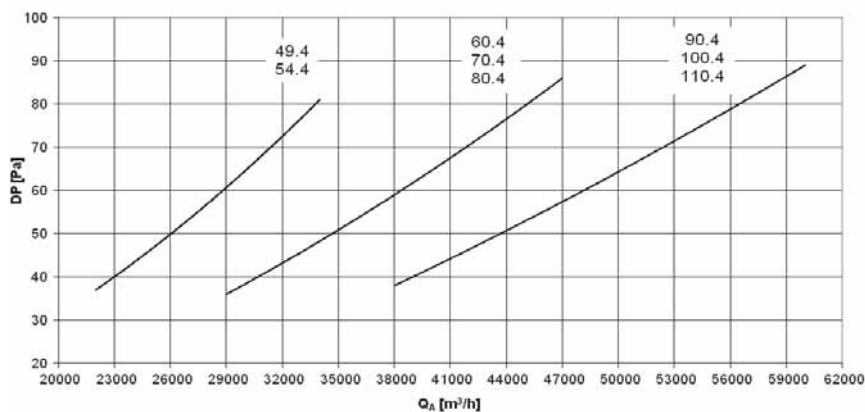

The air side pressure drops are relative to the medium air temperature of 20°C and are to be added to the pressure drops due to ducts, terminal devices and any other component that causes a drop in working discharge head.

QA [m³/h] = airflow
DP[Pa] = pressure drops

Hot water coil pressure drops: WATER side

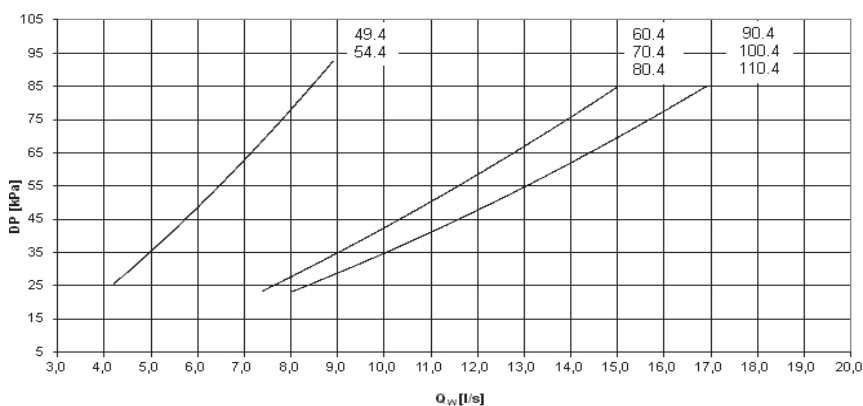

Pressure drops on the water side are calculated considering an average water temperature of 65°C

Qw [l/s] = water flow-rate
DP[kPa] = pressure drops

$$Qw [l/s] = P / (4.186 \times DT)$$

P = Water coil heating capacity in KW
DT = Temperature difference between inlet / outlet water

This option reduces the available static pressure (supply air side).



The component requires connection to the hot water plumbing system (to be provided for by the client).



'Electric elements', '2-row hot water coil' and 'Energy recovery from food refrigeration' cannot be assembled simultaneously.

Performances of water heating coil for food refrigeration

SIZE		Ti/To (°C)									
		45 / 40	40 / 35	35 / 30	45 / 40	40 / 35	35 / 30	45 / 40	40 / 35	35 / 30	
		kWt	kWt	kWt	kWt	kWt	kWt	kWt	kWt	kWt	
49.4 54.4	Qo (m³ / h)	22000			28000			34000			
	Qo (l / s)	4444			5556			6667			
	TM (°C)	5	200,8	173,6	146,3	239,2	206,6	174,0	274,1	236,6	199,1
		10	172,6	145,5	118,4	205,5	173,1	140,7	235,5	198,4	161,0
		14	150,2	123,4	96,3	178,9	146,7	114,4	205,0	168,0	130,8
		16	139,3	112,4	85,4	165,8	133,6	101,4	190,0	153,0	115,8
		18	128,2	101,4	74,6	152,7	120,6	88,4	174,9	138,0	101,0
20	117,3	90,6	63,7	139,6	107,6	75,5	159,9	123,1	86,1		
60.4 70.4 80.4	Qo (m³ / h)	29000			38000			47000			
	Qo (l / s)	4889			6111			7222			
	TM (°C)	5	265,1	228,9	192,5	322,3	278,2	233,7	373,9	322,5	270,7
		10	227,5	191,6	155,6	276,7	232,8	188,7	321,2	269,9	218,5
		14	198,0	162,2	126,5	240,8	197,0	153,2	279,3	228,3	177,3
		16	183,3	147,7	112,0	222,9	179,2	135,6	258,6	207,7	156,8
		18	168,8	133,2	97,6	205,2	161,7	118,1	237,9	187,1	136,4
20	154,3	118,9	83,3	187,5	144,1	100,6	217,4	166,8	116,0		
90.4 100.4 110.4	Qo (m³ / h)	38000			49000			60000			
	Qo (l / s)	5333			6667			7500			
	TM (°C)	5	348,3	301,1	253,7	418,8	361,7	304,5	482,6	416,5	350,6
		10	299,3	252,4	205,4	359,8	303,2	246,4	414,7	349,3	283,5
		14	260,6	214,0	167,2	313,3	257,0	200,5	361,0	295,9	230,5
		16	241,5	195,0	148,3	290,2	234,1	177,6	334,6	269,4	204,2
		18	222,5	176,0	129,5	267,4	211,2	155,0	308,1	243,1	177,9
20	203,5	157,2	110,7	244,5	188,5	132,3	281,7	216,9	151,8		

TM = air inlet temperature of water coil (°C)

Ti/To = water temperature inlet/outlet (°C)

Qo = airflow (l/s and m³/h)

kWt = Provided heating capacity (kW)

Thermal yields referred to the max. water coil capacity. The thermo regulator cokes the 3-way modulating valve limiting the inlet air temperature at desired values.

3WVM - Modulating 3-way valve for energy recovery from food refrigeration

To be combined with water coil for the energy recovery from food refrigeration. It is managed by the built-in microprocessor via a 0-10V signal and allows the fully automatic control of the water coil. The valve with modulating actuator is provided already assembled and wired built-in the unit.

Valve pressure drops

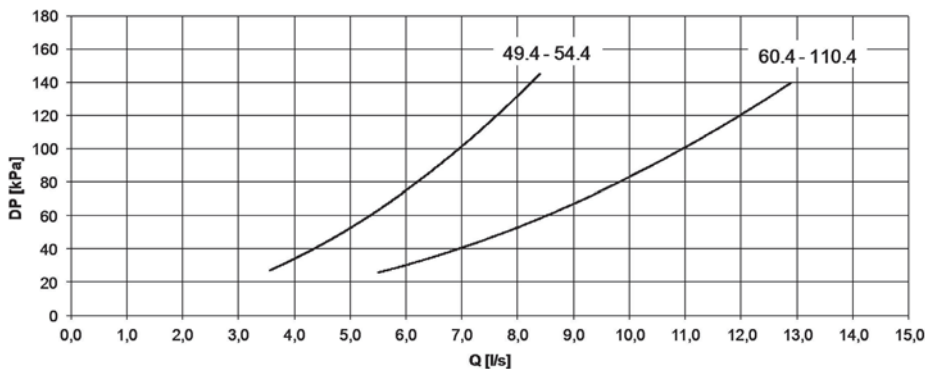

Q [l/s] = water flow-rate
DP [kPa] = pressure drops



This accessory has to be coupled to the "CHWER - Energy recovery from food refrigeration" option

LTEMP1 - Application for low outdoor temperature

Option indicated for very cold climates, where the outside temperature can be between -10 and -30°C.

- A. The option includes self-regulating heaters with thermostats that can protect the electrical panel from freezing to make sure it operates correctly.
- B. The special version of the outdoor air damper for the application for low outdoor temperature is made of anti-seize devices that facilitate the correct control of the fresh air in every climatic situation, thanks to the teflon supporting bushings, aluminium flaps, PVC end gaskets and steel leverages to compensate expansions.
- C. The motorised actuator is suitable for operating with low outdoor temperatures
- D. Electrical connection cables suitable for outdoor low temperatures.

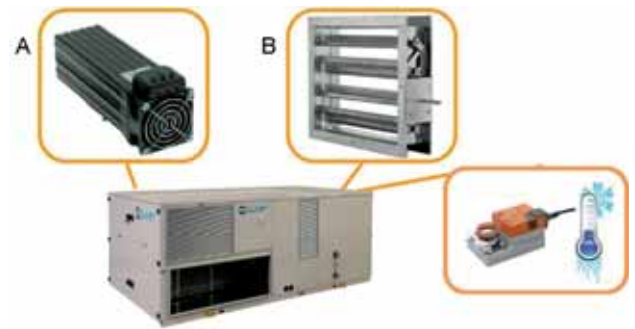

This operation involves variation of the main electrical data of the unit.



This accessory operates even when the unit is switched off provided that the power supply is maintained active and the unit continues to be connected.



It is necessary to make precautions against build up of snow and ice in front of the exhaust and outdoor air inlet locations.

PCOSM - Constant supply airflow

The original technology used eliminates the need for on-site calibration of traditional fans, as well as the time that would be required and the associated costs. The required flow rate is set on the display and maintained automatically by the unit, which controls the speed of the ventilating sections. During the installation and start-up phase, the unit controls to the effective pressure drop in the air distribution and diffusion system. Furthermore, during its entire operating life, the progressive fouling of the air filters is automatically compensated for thanks to this system.

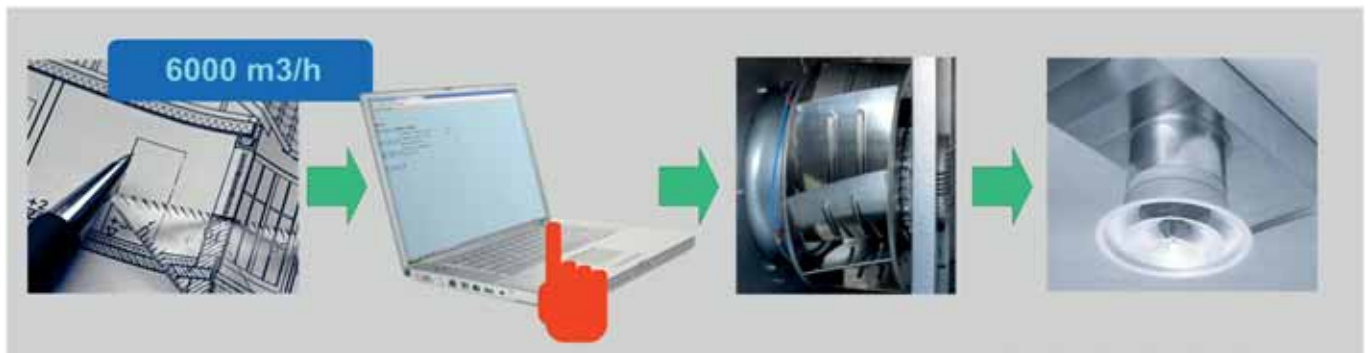

PVAR - Variable airflow

Option that enables the automatic variation of the treated air flow, according to the effective load. This allows great energy saving, thanks to the reduction of ventilation electrical consumptions. The minimum flow value equal to 60% of the nominal one occurs during the partial load and satisfied set-point operation. As a result, the supply temperature remains unchanged either during full load operation or partial load operation. The device also includes the functions of configuration of the nominal flow directly on the unit display and its automatic control to compensate the dirtying of the air filters.

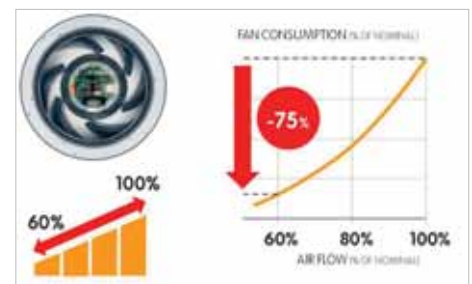

This option already includes the device for controlling the airflow, called 'PCOSM - Supply constant airflow', which must not be selected



When sizing the distribution and diffusion of the air, keep into consideration that the airflow varies from the nominal value (at full load, in FREE-COOLING mode and during the defrosting phases) to the minimum value, equal to 60% of the nominal flow (at partial load)

CPHG - Hot gas re-heating coil

This option is recommended during the summer when the intake air dehumidification is required.

The air flow to enter the room may contain a higher level of humidity than desired. The dehumidification process is used to reduce it. The air flow is first cooled in the handling coil with separation of condensation. It is then freely re-heated to maintain the desired condition of comfort in the served room.

The re-heat coil is located behind the handling coil and is activated by diverting a flow of hot refrigerant gas downstream from the compressors through the action of a dedicated solenoid valve.

The process starts operating based on the humidity set-point established by the user.

With respect to traditional devices, such as electrical electric elements or hot water coils, use of the re-heat coil does not consume any extra energy. It also lowers refrigerant condensation temperature, which provides two positive effects: power absorbed by the compressors is considerably reduced, and at the same time, cooling capacity is increased, resulting in greater efficiency (EER).

Ambient humidity is measured by means of a return humidity probe, which is provided already assembled and wired built-in the unit.

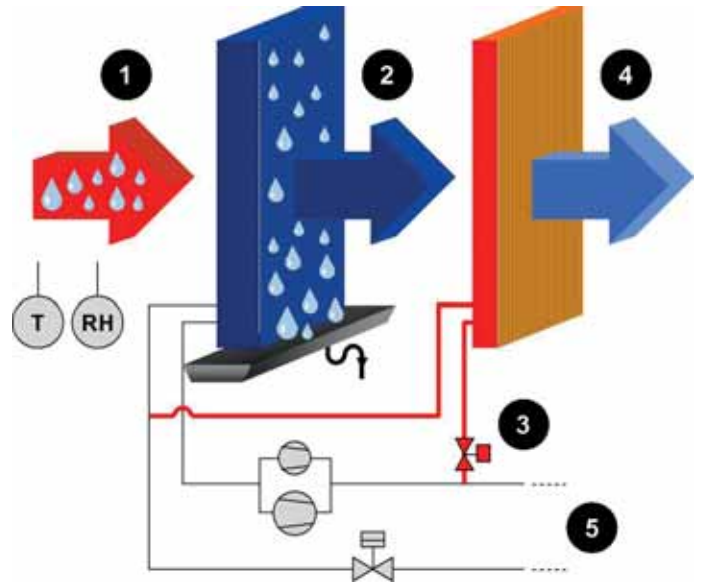

1. Outdoor air and humidity / temperature probe
2. Chilled and dehumidified air in the internal exchanger (evaporator)
3. Automatic hot gas pump valve
4. Air treated by the post-heating exchanger
5. External exchanger (condenser)

Indicative scheme - not in scale

This option reduces the available static pressure (supply air side).

Performances of hot gas re-heating coil

SIZE		OUTDOOR AIR TEMPERATURE (°C)															
		25	27	30	32	35	25	27	30	32	35	25	27	30	32	35	
		kWt	kWt	kWt	kWt	kWt	kWt	kWt	kWt	kWt	kWt	kWt	kWt	kWt	kWt	kWt	
49.4	Qo (m3 / h)	22000					26000					34000					
	Qo (l / s)	6111					7222					9444					
	Ta (°C)	10	45,9	49,5	54,8	58,4	63,9	51,2	55,2	61,2	65,3	71,4	59,2	63,8	70,8	75,5	82,6
		12	42,3	45,8	51,2	54,8	60,2	47,2	51,2	57,1	61,1	67,2	54,5	59,1	66,1	70,8	77,8
		14	38,7	42,2	47,5	51,1	56,5	43,2	47,1	53,0	57,1	63,1	49,9	54,5	61,3	66,0	73,0
		16	35,2	38,7	44,0	47,5	52,9	39,2	43,1	49,0	53,0	59,0	45,2	49,8	56,7	61,3	68,3
		18	31,6	35,1	40,4	43,9	49,3	35,2	39,2	45,0	49,0	55,0	40,7	45,2	52,0	56,6	63,6
20	28,1	31,6	36,8	40,3	45,7	31,3	35,2	41,1	45,0	50,9	36,1	40,6	47,4	52,0	58,9		
54.4	Qo (m3 / h)	22000					29000					34000					
	Qo (l / s)	6111					8056					9444					
	Ta (°C)	10	46,4	50,0	55,4	59,0	64,6	54,6	58,8	65,2	69,6	76,1	59,8	64,5	71,5	76,3	83,5
		12	42,7	46,3	51,7	55,3	60,8	50,3	54,5	60,9	65,2	71,7	55,1	59,7	66,7	71,5	78,6
		14	39,1	42,7	48,0	51,6	57,1	46,0	50,2	56,5	60,8	67,3	50,4	55,0	62,0	66,7	73,8
		16	35,5	39,1	44,4	48,0	53,4	41,7	45,9	52,2	56,5	62,9	45,7	50,3	57,2	61,9	69,0
		18	32,0	35,5	40,8	44,3	49,8	37,5	41,7	48,0	52,2	58,6	41,1	45,7	52,5	57,2	64,2
20	28,4	31,9	37,2	40,7	46,1	33,4	37,5	43,8	47,9	54,3	36,5	41,1	47,9	52,5	59,5		
60.4	Qo (m3 / h)	29000					33000					47000					
	Qo (l / s)	8056					9167					13056					
	Ta (°C)	10	61,7	66,4	73,5	78,4	85,7	67,3	72,5	80,3	85,6	93,6	81,8	88,1	97,7	104,2	113,9
		12	56,8	61,6	68,7	73,5	80,8	62,0	67,2	75,0	80,2	88,2	75,4	81,7	91,2	97,6	107,4
		14	52,1	56,8	63,9	68,6	75,9	56,8	62,0	69,7	74,9	82,8	69,0	75,3	84,7	91,2	100,8
		16	47,4	52,0	59,1	63,8	71,0	51,7	56,8	64,5	69,7	77,5	62,7	69,0	78,3	84,7	94,3
		18	42,7	47,3	54,3	59,0	66,2	46,5	51,6	59,3	64,4	72,2	56,4	62,6	72,0	78,3	87,9
20	38,0	42,6	49,6	54,3	61,4	41,4	46,5	54,1	59,2	67,0	50,2	56,4	65,7	72,0	81,5		

Ta = leaving air temperature from the handling coil and entering the post-heating coil

Qo = airflow (l/s)

kWt = Heating capacity (kW)

The reheating coil is powered by the cold gas bled from the condensing coil.

As the condensation hot gas temperature is linked to the outdoor air temperature, the indicative potentials of the post-heating coil are expressed according to the outdoor air temperature.

SIZE		OUTDOOR AIR TEMPERATURE (°C)															
		25	27	30	32	35	25	27	30	32	35	25	27	30	32	35	
		kWt	kWt	kWt	kWt	kWt	kWt	kWt	kWt	kWt	kWt	kWt	kWt	kWt	kWt	kWt	
70.4	Qo (m3 / h)	29000					37000					47000					
	Qo (l / s)	8056					10278					13056					
	Ta (°C)	10	62,3	67,1	74,3	79,2	86,6	72,0	77,5	85,9	91,6	100,2	82,6	89,0	98,7	105,2	115,1
		12	57,4	62,2	69,4	74,2	81,6	66,4	71,9	80,2	85,9	94,4	76,1	82,5	92,1	98,6	108,4
		14	52,6	57,4	64,5	69,3	76,6	60,8	66,3	74,6	80,2	88,7	69,7	76,1	85,6	92,1	101,8
		16	47,8	52,6	59,7	64,5	71,7	55,2	60,7	68,9	74,5	83,0	63,3	69,7	79,1	85,6	95,3
		18	43,1	47,8	54,9	59,6	66,8	49,7	55,2	63,4	68,9	77,3	57,0	63,3	72,7	79,1	88,8
20	38,4	43,1	50,1	54,8	62,0	44,3	49,7	57,9	63,4	71,7	50,7	57,0	66,4	72,7	82,3		
80.4	Qo (m3 / h)	29000					44000					47000					
	Qo (l / s)	8056					12222					13056					
	Ta (°C)	10	62,9	67,8	75,0	80,0	87,4	79,6	85,7	95,0	101,3	110,8	83,4	89,9	99,7	106,3	116,2
		12	58,0	62,8	70,1	75,0	82,4	73,3	79,5	88,7	95,0	104,4	76,9	83,3	93,0	99,6	109,5
		14	53,1	57,9	65,1	70,0	77,4	67,1	73,3	82,4	88,7	98,1	70,4	76,8	86,5	93,0	102,9
		16	48,3	53,1	60,3	65,1	72,4	61,0	67,1	76,2	82,4	91,8	63,9	70,3	79,9	86,4	96,2
		18	43,5	48,3	55,4	60,2	67,5	54,9	61,0	70,0	76,2	85,5	57,6	63,9	73,4	79,9	89,7
20	38,8	43,5	50,6	55,4	62,6	48,9	54,9	64,0	70,0	79,3	51,2	57,5	67,1	73,4	83,1		
90.4	Qo (m3 / h)	38000					51000					60000					
	Qo (l / s)	10556					14167					16667					
	Ta (°C)	10	80,5	86,6	95,9	102,2	111,7	96,1	103,6	114,7	122,3	133,7	105,0	113,1	125,3	133,6	146,1
		12	74,2	80,4	89,6	95,9	105,3	88,7	96,1	107,2	114,7	126,1	96,8	104,9	117,0	125,3	137,7
		14	68,0	74,2	83,3	89,6	99,0	81,3	88,6	99,7	107,2	118,4	88,7	96,8	108,8	117,0	129,4
		16	61,9	68,0	77,1	83,3	92,7	73,9	81,2	92,2	99,6	110,9	80,6	88,7	100,7	108,8	121,1
		18	55,8	61,9	71,0	77,1	86,4	66,6	73,9	84,8	92,2	103,4	72,6	80,6	92,5	100,7	112,9
20	49,8	55,8	64,8	70,9	80,2	59,3	66,6	77,5	84,8	95,9	64,7	72,6	84,5	92,6	104,7		
100.4	Qo (m3 / h)	38000					56000					60000					
	Qo (l / s)	10556					15556					16667					
	Ta (°C)	10	80,9	87,0	96,4	102,7	112,3	100,9	108,8	120,5	128,5	140,4	105,5	113,7	126,0	134,3	146,8
		12	74,6	80,8	90,1	96,4	105,8	93,1	100,8	112,5	120,5	132,4	97,3	105,4	117,6	125,9	138,4
		14	68,4	74,5	83,8	90,0	99,5	85,3	93,1	104,6	112,5	124,4	89,1	97,3	109,4	117,6	130,0
		16	62,2	68,3	77,5	83,7	93,1	77,6	85,3	96,8	104,6	116,4	81,0	89,1	101,2	109,4	121,7
		18	56,1	62,2	71,3	77,5	86,8	69,9	77,5	89,0	96,8	108,5	73,0	81,0	93,0	101,2	113,5
20	50,0	56,0	65,2	71,3	80,6	62,2	69,8	81,2	89,0	100,7	65,0	73,0	84,9	93,0	105,2		
110.4	Qo (m3 / h)	38000					56000					60000					
	Qo (l / s)	10556					15556					16667					
	Ta (°C)	10	81,3	87,5	96,9	103,3	112,8	101,4	109,3	121,1	129,1	141,1	106,1	114,2	126,6	135,0	147,6
		12	75,0	81,2	90,5	96,8	106,4	93,6	101,4	113,1	121,1	133,1	97,8	105,9	118,2	126,6	139,1
		14	68,7	74,9	84,2	90,5	100,0	85,7	93,5	105,2	113,1	125,0	89,6	97,7	109,9	118,2	130,7
		16	62,5	68,7	77,9	84,1	93,6	78,0	85,7	97,3	105,2	117,0	81,4	89,5	101,7	109,9	122,3
		18	56,4	62,5	71,7	77,9	87,3	70,2	77,9	89,4	97,3	109,1	73,4	81,4	93,5	101,7	114,0
20	50,3	56,3	65,5	71,6	81,0	62,6	70,2	81,6	89,4	101,2	65,3	73,3	85,3	93,5	105,8		

Ta = leaving air temperature from the handling coil and entering the post-heating coil

Qo = airflow (l/s)

kWt = Heating capacity (kW)

The reheating coil is powered by the cold gas bled from the condensing coil.

As the condensation hot gas temperature is linked to the water temperature, the indicative potentials of the post-heating coil are expressed according to the leaving external exchanger water temperature.

FES - H10 high efficiency electrostatic air filter

Class H10 high-efficiency filters are additional filtering components with an active electrostatic system. Solid or liquid particles contained in the air flow are trapped by an electrical field. The air flow through the filter is affected in two main phases: release of an electrical charge to the particles (ionization), and capture of the particles by electrostatic deposit (captivation). Periodically the filters must be cleaned to remove the captured particles (washing). The filters are able of trapping fine dusts, some types of viruses and micro-organisms (anti-bacterial action) with very modest pressure drops. The range of use normally includes fine powders that measure less than 1 µm. Typical pollutants are cigarette smoke (0.5÷0.3 µm), oily vapours (1÷0.2 µm), PM10 (particles < 10 µm), PM2.5 (particles < 2.5µm), PM1 (particles < 1µm), etc. The clogging of the electric filter is signalled by a sensor that allows to schedule the periodic maintenance, which can be easily performed by washing in water with a special non-aggressive detergent for aluminium. The greater initial cost, as compared to a traditional pocket filter, is recovered quickly since the electrostatic filters last for the entire life of the unit, whereas pocket filters require periodic replacement.

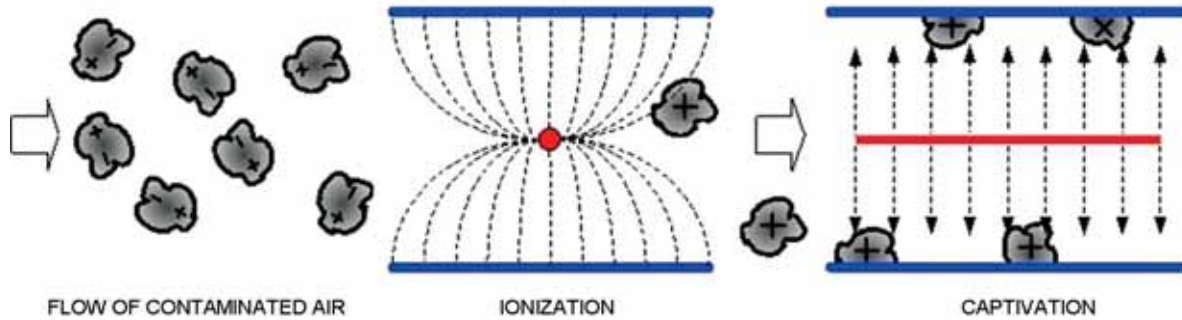

This option reduces the available static pressure (supply air side).



The electronic filters are not suited to filter water steams also in low concentration, oily vapours, large amounts of dust, shavings, powdered iron filings and residues generally, gas. The electronic filters have to absolutely avoid all the following substances: powdered metals also fine, smoke produced by combustion of organic materials and not, flour dusts, dusts and vapours of explosive environments.

F7 - F7 high efficiency air filter

The class F7 are filtering components that are in addition to the standard G4 filters, for more effective filtering. They are widely used in air conditioning systems and industrial applications that require suitable performance concerning fine dusts and particles with dimensions greater than 1 µm. Class F7 filters are made of fibreglass paper, pleated with constant calibrated spacing, mounted on a metallic frame; the ample filtering surface reduces air side pressure drops. Class F7 filters must be replaced after reaching their limits of dirtiness with scheduled periodic maintenance. An optional accessory, dirty filter differential switch, can be fitted to signal when admissible limit of fouling has been reached so as not to excessively reduce the airflow with respect to the nominal value



This option reduces the available static pressure (supply air side).

PSAF - Clogged filter differential pressure switch air side

It makes it possible to detect and signal (with a suitable alarm) when the dirtiness of the air filter reaches its maximum level. This provides the unit operator with information on when filter maintenance is required. The detection signal is installed in the unit. It is already connected to the electrical panel and pre-calibrated in the factory. Calibration can be modified by an authorized personnel.



CECA - Copper / aluminium coil with acrylic lining

Coils with copper pipes and aluminium fins with acrylic lacquering. Can be used in settings with moderately aggressive low saline concentrations and other chemical agents. Attention!

- Cooling capacity variation -2.7%
- Variation in compressor power input +4.2%
- Operating range reduction -2.1°C



Option available on request



CCCA1 - Copper/aluminum coil with Fin Guard (Silver) treatment

A treatment which offers an optimal thermal exchange and guarantees and protects the finned coil exchangers from corrosion over time. Can be used in settings with very aggressive saline concentrations and other chemical agents in the air thus maintaining the performance of the coils over time.



Option available on request



CCCC - Copper / copper coil

Coils with copper pipes, copper fins and brass structure. Can be used in settings with moderately aggressive saline concentrations and other chemical agents. The options are available for:

- external coil
- internal coil
- hot water coil
- re-heating coil

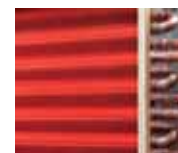

This option is not suitable for application in sulphuric environments



Option available on request

HSE - Immersed electrodes steam humidifier

This device is suitable for winter operation when humidity is required for the ambient without cooling the air flow.

The automatic modulating control allows you to adjust the steam production and its relative management costs to the actual requirements.

Available in different capacities, the device is suitable for using soft water having medium conductivity and is equipped with: water load solenoid valve, disposable cylinder, water drainage solenoid valve, distribution nozzle, control electronic board to verify the water level, conductivity, anti-foam device, water drainage manual forcing. To ensure maximum hygiene, the cylinder can automatically empty after a determined period of stand-by.

The accessory is installed inside the unit and is connected to the electrical panel of the unit.

Ambient humidity is measured by means of a return humidity probe, which is provided already assembled and wired built-in the unit.

With the option is available a potential-free contact for the water emptying during the period in which the unit is not used (connection provided by the Customer).



Matching of immersed electrode and steam humidification module

Size	49.4	54.4	60.4	70.4	80.4	90.4	100.4	110.4
8 kg/h	√	√	√	√	√	√	√	√
15 kg/h	√	√	√	√	√	√	√	√



This option involves variation of the main electrical data of the unit.



This accessory requires connection to a water supply network and discharge water circuit with adequate frost protection. Requires its own power supply and have to be connected to the unit. Installation and wiring to customer care.



HWS - Water to waste evaporating wet-deck humidifier

This option is recommended when quick, efficient humidification of the served room during winter operation is required. Humidification of the air mixture occurs by passing the air flow through a honeycomb package that is kept humid at all times by a series of nozzles that inject water in small drops. The reserve of water for treatment is taken directly from the water mains. During operation, the pure water vapour is mixed with the air currents. The remaining part, enriched with mineral salts, is collected in the tub and eliminated. The constant exchange of water ensures cleaning of the evaporation septum and provides maximum limitation of the formation and proliferation of Legionnaire's Disease. With this option, energy consumption for water evaporation is limited. Whenever the packaged humidifier is active, in addition to humidifying, adiabatic cooling of the air takes place, which is constantly compensated for by the thermal control device. Direct connection to the plumbing system eliminates the need for special water treatment and easy control of the humidification process by means of the measuring and adjusting device of the water flow rate provided standard.



The accessory is installed inside the unit and is connected to the electrical panel of the unit.

Ambient humidity is measured by means of a return humidity probe, which is provided already assembled and wired built-in the unit.

Calculation of evaporating water flow from the humidifier

Size		49.4	54.4	60.4	70.4	80.4	90.4	100.4	110.4
TA (°C) D.B.	TA (°C) W.B.	kg/h	kg/h	kg/h	kg/h	kg/h	kg/h	kg/h	kg/h
30	15,1	75	84	95	107	127	147	161	173
35	17,6	94	104	119	133	158	184	202	216
40	19,8	114	127	145	162	193	223	245	263

Ta D.B.= dry bulb temperature of inlet air to the wet deck.

Ta W.B.= wet bulb temperature of inlet air to the wet deck.

Approximate values of the maximum rate of steam released by the steam humidifier to the air to obtain controlled thermal and humidity conditions in supply. The data refer to a unit with standard airflow in supply.

Calculating water flow to the humidifier

Size		49.4	54.4	60.4	70.4	80.4	90.4	100.4	110.4
TA (°C) D.B.	TA (°C) W.B.	l/min	l/min	l/min	l/min	l/min	l/min	l/min	l/min
30	15,1	3	3	4	4	5	6	7	7
35	17,6	4	4	5	6	7	8	8	9
40	19,8	5	5	6	7	8	9	10	11

Ta D.B.= dry bulb temperature of inlet air to the wet deck.

Ta W.B.= wet bulb temperature of inlet air to the wet deck.

Approximate values of the maximum rate of steam released by the steam humidifier to the air to obtain controlled thermal and humidity conditions in supply. The data refer to a unit with standard airflow in supply.

The table shows the indicative water flow rates for the calibration of the flow rate meter supplied with the wet pack. The values have been obtained considering an average efficiency of the wet pack equal to 50%

This option reduces the available static pressure (supply air side).



This accessory requires connection to a water supply network and discharge water circuit. To customer care.



Not available if re-heating is present.

- during use there will be a part of water that will be dispersed and not totally supplied to the air flow, this to ensure the humidification of the entire surface and to carry out a continuous washing of the septum.
- do not use particularly hard water. The presence of limestone (CaCO₃) may lead to progressive obstruction to water distribution
- the humidification effect can be reduced over time depending on the quality of the water used and the progressive deterioration of the component materials.

PAQC - Air quality probe for the CO2 rate check

This option is recommended for areas with highly variable crowding. The probe measures the amount of CO₂ in the environment and initiates a 0/10V proportional signal. Based on the received signal, the controller regulates amount of outdoor air necessary for IAQ ventilation and thus minimises energy used for treatment.

The probe is installed and wired built-in the unit and is located in the return air duct of the unit.



PAQCV - Air quality probe for the CO2 and VOC rate check

The option is recommended in areas with tobacco smoke, formaldehyde (from solvents, deodorants, glues, paints, detergents, food preparation, etc). The probe measures the rate of CO₂ and VOC (volatile organic compounds) in the environment and initiates a 0/10V proportional signal. Based on the received signal, the controller regulates amount of outdoor air necessary for IAQ ventilation and thus minimises energy used for treatment.

The probe is installed and wired built-in the unit and is located in the return air duct of the unit.



DESM - Smoke detector

This option allows detection of smoke in the room by analyzing the return air. The Tyndal-effect increased sensitivity smoke detector is perfect for ventilation ducts since it is able to detect rarefied smoke in high-speed air flows. Smoke detection occurs using a photo-optical system with a labyrinth chamber. The alarm signal is processed by a built-in micro-processor which verifies the condition and sends a message to the unit controller such as smoke alarm, failure, or service required. The device is installed inside the return duct and it is made up of a sensor, installed inside the return piping, and of a controller that is located on the outside duct.



Control logics in the event of alarm signal

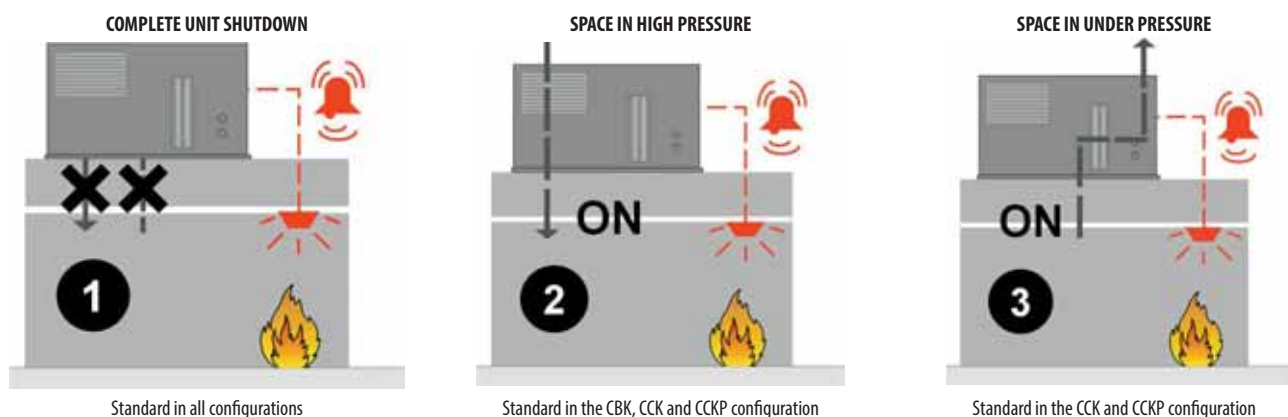

The unit is able to manage the signal coming from a fire detection system or fire control unit installed built-in, activating one of the logics illustrated, which can be set by parameters. In presence of alarm signal, the compressors are always switched off; moreover, the remote ON-OFF is disabled together with the switch on/off control from keypad. The unit is manually reset. Rooftop units cannot be used as fume extractor.



Any fire detection devices built-in the unit must be considered as an auxiliary safety system, and, accordingly, must not be a replacement for any fire detection devices in the room.

PCM0 - Sandwich panels of the handling zone in M0 fire reaction class

Option indicated when, by law, the air treatment area must have metallic internal walls made with fire-proof insulating material. Sandwich panels with dual walls made of steel sheet metal with fire-proof insulation made of Rockwool (90 kg/m³) comply with the French standards, which require "M0" reaction to fire class.

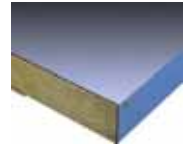

MHP - High and low pressure gauges

Allows the pressure measurement of the refrigerant to the compressor intake and supply, making the inspection of these parameters easier for the technicians involved in the management of the unit.

The two liquid pressure gauges and corresponding pressure sockets are installed built-in the unit in an easily accessible location.



PTCO - Set up for shipping via container

Option that allows shipping via container.

It includes the sheet steel slide application for an easy unit scrolling, packaging with protective angle brackets and nylons, anchoring systems. If necessary the lateral lifting brackets and the main isolator switch handle can be removed to avoid damages during transport (components removed and put inside the unit).

For particular requirements, please contact Clivet Shipping Department.

VENH - High static pressure fans

A higher capacity fan section is available for applications requiring high supply and return head. The option is comprised of radial fans coupled directly to electronically controlled motors (brushless). When you select a unit on the www.clivet.com website, if you enter the air flow, the available supply and return pressure and the accessories that determine the head loss on the air side, you will be automatically shown a selection of high head fans, when required.



FCE - Enthalpic FREE-COOLING (only for CCK and CCKP configuration)

This option is used to reduce energy consumption and compressor wear by using the outdoor air as an energy source to lower the thermal loads and ambient humidity. The temperature control compares the temperature and the humidity between the outdoor environment and the served environment and decides the amount of fresh air needed to guarantee the correct temperature and humidity set-points in the environment, keeping the compressors shut off.

The air humidity, both outside and inside the environment, is measured by means of humidity probes on the outdoor and return air intake, which are provided already installed and wired on the unit.

SFSTC - Progressive compressor start-up Soft starter

This option is also known as "Soft starter". An electronic device which automatically starts up the compressors gradually, reducing the starting current for the unit by around 40% in comparison with the nominal value. This results in the electrical capacity system and the related protection devices being sized with lower parameters, thus having a lower initial investment cost.

The device is installed and wired built-in the unit.

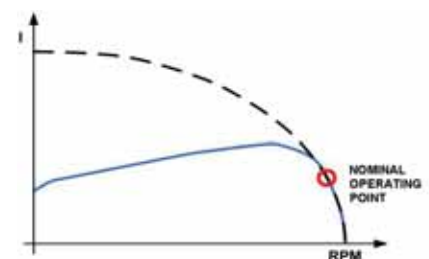

(---) POWER INPUT WITHOUT SFSTC OPTION
 (—) POWER INPUT WITH SFSTC OPTION

MOB - Serial communication module for Modbus supervisor

This enables the serial connection of the supervision system, using Modbus as the communication protocol. It enables access to the complete list of operational variables, commands and alarms. Using this accessory every unit can dialogue with the main supervision systems.

The device is installed and wired built-in the unit.



The total length of each serial line do not exceed 1000 meters and the line must be connected in bus typology (in/out)

LON - Serial communication module for LonWorks supervisor

It allows the serial connection to supervision systems, using LonWorks as the communication protocol. It allows access to a list of operating variables, control and alarms compliant with the Echelon standard.

The device is installed and wired built-in the unit.



The configuration and management activities for the LonWorks networks are the responsibility of the client.



LonWorks technology uses the LonTalk® protocol for communicating between the network nodes. Contact the service supplier for further information.



The total length of each serial line do not exceed 1000 meters and the line must be connected in bus typology (in/out)

BACIP - Serial communication module for BACnet-IP supervisor

Allows the serial connection to supervision systems by using BACnet-IP as a communication protocol. It allows the access to the entire list of operating variables, controls and alarms. With this accessory every unit can communicate with the main supervision systems.

The device is installed and wired built-in the unit.



The configuration and management activities for the BACnet networks are the responsibility of the client.



The total length of each serial line do not exceed 1000 meters and the line must be connected in bus typology (in/out)

PFCC - Power factor correction capacitors (cosfi > 0.95)

The component is necessary to lower the phase difference between current and voltage in the electromagnetic components of the unit, such as asynchronous motors. By re-phasing it is possible to reduce the intensity of the line current by reducing a part of the power of the mains (reactive power). This leads to an economic benefit which the energy provider grants to the final user. The component makes it possible to bring the cosfi power factor to values which on average are greater than 0.95.

The device is installed and wired built-in the unit.



MF2 - Multifunction phase monitor

The phase monitor controls the electrical parameters of the power line to the unit. It works on the command circuit and orders the unit to be switched off when one of the following cases is present: when the phase connections do not respect the correct sequence, or when there is over voltage or under voltage for a certain amount of time (limit values of over and under voltage and the time interval can be manually and separately set). When the line conditions are re-established, the unit is re-armed automatically.

The device is installed and wired built-in the unit.



The device prevents sudden changes of voltage; however, the voltage must always be in a range between 380V and 480V.



NCRC - Remote control with user interface: not required

If you choose this option, the unit is supplied without a graphical control user interface, although it retains all the features. Option that can be chosen when there is a supervision system or another remote management device.



The remote control with user interface can be still used in conjunction with a supervision system and in general with a serial connection.

Water connection diagrams

Clivet's many years of experience with systems that use water as the carrier fluid for heat exchange, has led to the creation of hydraulic pipework arrangements that are suitable for any sort of system. The technical measures that have been implemented limit the occurrence of the most common installation problems and simplify the commissioning of the unit.

ACL - Internal water connections provided by the Customer (Standard)

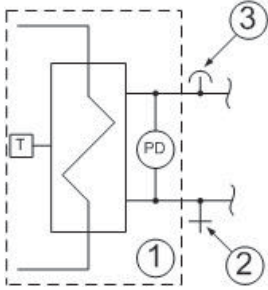

The standard unit is equipped with the following components:

1. plate heat exchanger complete with water side differential pressure switch (to control presence of water flow rate) and a water temperature control probe (to disable the compressors when the water temperature drops below the limit value);
2. drainage valve (to allow the exchanger to be drained for maintenance)
3. vent valve (to let air out of the system)

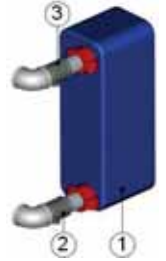

The component requires connection to the hot water plumbing system (to be provided for by the Customer).

ACPC - Hydraulic pipework arrangement for loop with constant flow-rate (Optional)

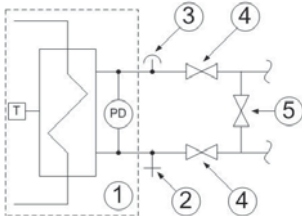

The hydraulic pipework arrangement for the constant flow-rate loop includes, in addition to the standard components, the following:

1. plate heat exchanger complete with water side differential pressure switch (to control presence of water flow rate) and a water temperature control probe (to disable the compressors when the water temperature drops below the limit value);
2. drainage valve (to allow the exchanger to be drained for maintenance)
3. bleed cock (to allow venting of air from the system);

The additional components:

4. two-way manually activated valves located at the inlet and outlet of the water side exchanger (to make it possible to disconnect the unit from the hydraulic pipework arrangement system for maintenance);
5. manually activated two-way valve for loop wash by-pass (to allow washing of the pipes of the system and protect the heat exchanger against fouling);

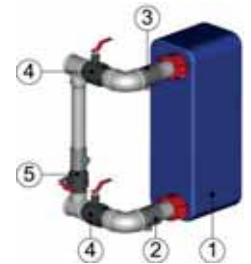

The component requires connection to the hot water plumbing system (to be provided for by the Customer).

ACPV - Hydraulic pipework arrangement for loop with variable flow-rate (Optional)

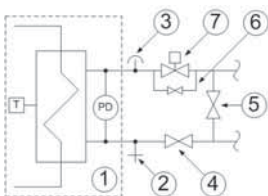

The hydraulic pipework arrangement for the variable flow-rate loop includes, in addition to the standard components, the following:

1. plate heat exchanger complete with water side differential pressure switch (to control presence of water flow rate) and a water temperature control probe (to disable the compressors when the water temperature drops below the limit value);
2. drainage valve (to allow the exchanger to be drained for maintenance)
3. bleed cock (to allow venting of air from the system);

The additional components:

4. two-way manually activated valves at the inlet of the water side exchanger (to make it possible to disconnect the unit from the hydraulic pipework arrangement for maintenance);
5. manually activated two-way valve for loop wash by-pass (to allow washing of the pipes of the system and protect the heat exchanger against fouling);
6. anti-freeze by-pass (to allow water to seep through when the valve is closed, thus avoiding the risk of freezing of the water in the pipes) with manual shut-off valve;
7. two-way motorize ON/OFF valve located at the outlet of the heat exchanger (operation is linked to that of the refrigeration circuit: with the compressor off the valve stays closed and as a result less water is used);

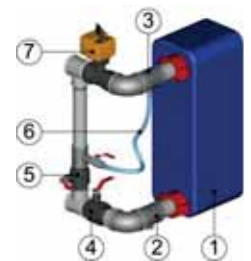

ACPM - Hydraulic pipework arrangement for system with disposable water (Optional)

The hydraulic pipework arrangement for systems with disposable water (groundwater) includes the following, in addition to the standard components:

1. plate heat exchanger complete with water side differential pressure switch (to control presence of water flow rate) and a water temperature control probe (to disable the compressors when the water temperature drops below the limit value);
2. drainage valve (to allow the exchanger to be drained for maintenance)
3. vent valve (to let air out of the system)
4. two-way manually activated valves at the inlet of the water side exchanger (to make it possible to disconnect the unit from the plumbing system for maintenance);
5. manually activated two-way for loop wash by-pass (to allow washing of the pipes of the system and protect the heat exchanger against fouling);
6. anti-freeze by-pass (to allow water to seep through when the valve is closed, thus avoiding the risk of freezing of the water in the pipes) with manual shut-off valve;
7. two-way modulating motorized valve located at the outlet of the heat exchanger (operation is in conjunction with that of the refrigeration circuit: by modulating its opening via the 0-10V signal, water consumption is reduced and the operating values of the unit are kept within allowed limits);

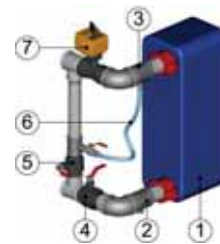
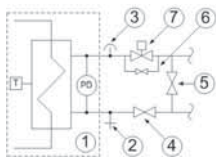

In summer operation, the device, complete with modulating valve, makes it possible to maximize the thermal differential of the water and hence to reduce the water flow rate. In winter operation, modulation of the water flow rate allows the unit to function with the water loop at high temperature. An additional advantage of using this device is the extension of the operating limits of the unit in summer and winter.

The water flow rate value and the corresponding pressure drop is available on www.clivet.com website. The technical datum is determined in function of the chosen hydraulic pipework arrangement and the selected heating and cooling performance.

The standard supply includes the internal piping to the external panel of the unit, two hydraulic fittings flush with unit, two adaptors to be brazed for the connection to system provided by the Customer.



ACIS - Antifreeze heater for exchanger protection, water side

The option makes it possible to avoid the formation of ice in the plate exchanger and to preserve its correct operation. This is an electric heating element fastened to the outside of the exchanger. It activates if the water temperature drops below a set limit. The device is recommended during the winter when the unit is in stand-by or if the system is not in use for long periods of time.

The device is installed and wired built-in the unit.



When the unit is electrically disconnected, the device is not in operation.



The device only protects the water side exchanger. Anti-freeze protection of the plumbing connections is the responsibility of the Customer.

Accessories separately supplied

AMRX - Rubber antivibration mounts

The rubber antivibration mounts must be fixed to designated housings on the support stringers and are used to dampen vibrations produced by the unit, thereby reducing the noise transmitted to the support structures. They are flexible bodies able to dampen axial and tangential stresses and maintain the mechanical properties almost constant over time thanks to high resistance materials of which they are made.

Alternatively, rubberized neoprene anti-vibration strips may be used on the unit longitudinal support members (not supplied by Clivet).



CLMX - Clivet Master System

CLIVET MASTER SYSTEM is the ideal system for the remote and centralised control of the CLIVETPack and SMARTPack climate control units. It can manage up to eight units connected with a serial connection.

It includes a box for wall installation, as well as the electronic power supply and serial communication devices, a controller with a touch-screen display and a USB port at the front used to export the alarm log.

The device allows to easily and intuitively access all the information on the status of the system and the climate control units. It also provides:

- auto-detection of units connected,
- setting all unit parameters,
- setting of the zone set-point
- unit status display,
- control and management of the alarms and creation of an alarm log,
- hourly operation scheduling (ON / OFF / ECO),
- rotation of the units even for individual areas,
- temperature, humidity and air quality trends
- automatic language management (English, Italian, French, Spanish and German)



The component must be combined with the RS485 serial port option with Modbus protocol built-in of each rooftop



Operating temperature from 0°C to 50°C with relative humidity lower than 90% without condensate

SIX - Service interface

The device allows to fully control the unit for start-up and maintenance operations conducted by authorised technical personnel. It must be connected on the outside of the unit via the RJ45 connector and the 1.5m connection cable that can be further extended. The device can be easily applied on the unit's surface thanks to the magnetic support. It is protected from the elements thanks to the IP68 protection. The control has a backlit screen, comfortable buttons and a graphical interface with a browsing menu and submenu.



All device functions can be repeated with a normal portable PC connected to the unit with an Ethernet cable and equipped with an internet navigation browser.

RCX - Roof curb

Option that allows to connect the unit to the building roof, ideal with downflow supply and return.

It is made up of two part, a solid steel frame for the air duct connection and a adjustment support in height. Both parts are made of galvanized steel with a steel rain cover profile painted in the same unit colour. It has an adequate support and a duct connection simplification. It is supplied not assembled and it has to be assembled directly in the construction site, to facilitate the transport and installation.

It is complete with adjusting screws to adapt to any slopes or difference in height of the cover.

Once the frame is assembled, it will be necessary to insulate and seal the roof curb to the roof to guarantee the resistance to atmospheric agents, later it will be necessary only to place the unit.

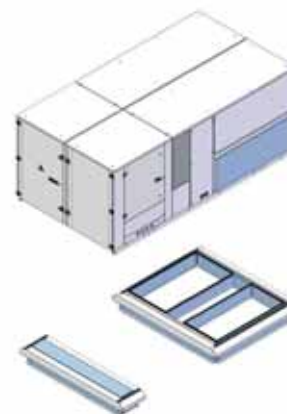

Option not available with gas module.



Installation provided by the Customer.

IFWX - Steel mesh strainer water side

The device is located up the line from the plate exchanger to keep it from getting dirty from possible impurities in the plumbing circuit. The mechanical filter in stainless steel mesh is easily removable for periodic maintenance and cleaning.



Steel mesh strainer pressure drops

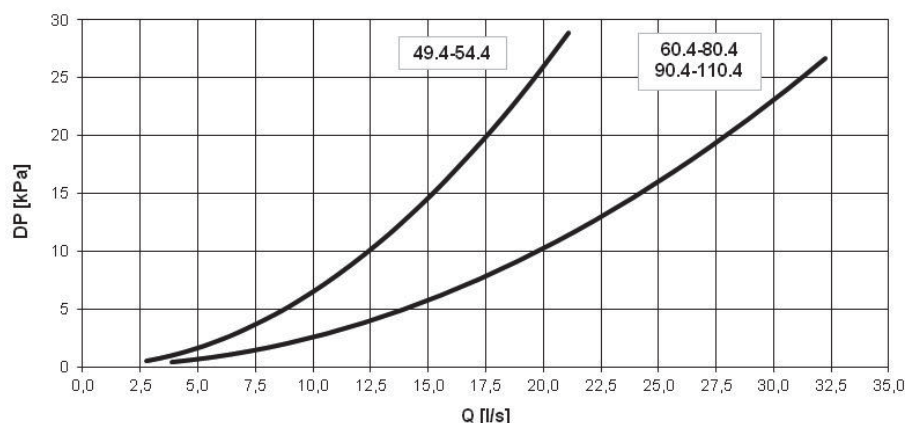

Q [l/s] = water flow-rate
DP = water side pressure drops [kPa]



Pressure drops with clean filters

Dimensions of steel mesh strainer

Size	49.4	54.4	60.4	70.4	80.4	90.4	100.4	110.4
Ø	3"	3"	4"	4"	4"	4"	4"	4"
Water filter	1,6	1,6	1,6	1,6	1,6	1,6	1,6	1,6

Performance

On the web site www.clivet.com are available the performances of the CBK, CCK and CCKP configurations.

Size 49.4 CAK configuration

Cooling performance with full recirculation

Airflow	Ta °C DB/WB	Water leaving temperature °C D.B./W.B.																							
		25				30				35				40				45				50			
		kWf	kWs	kWe	EER	kWf	kWs	kWe	EER	kWf	kWs	kWe	EER	kWf	kWs	kWe	EER	kWf	kWs	kWe	EER	kWf	kWs	kWe	EER
22000 m ³ /h	22 / 16	165,0	107,2	25,0	6,6	159,8	106,9	27,5	5,8	153,7	106,2	30,4	5,1	147,1	104,5	33,7	4,4	139,9	101,4	37,5	3,7	129,8	97,2	42,2	3,1
	24 / 17	171,6	112,9	25,1	6,8	166,2	112,6	27,6	6,0	159,7	112,0	30,5	5,2	152,6	110,4	33,9	4,5	144,9	107,1	37,6	3,9	134,9	102,2	42,3	3,2
	26 / 18	178,5	118,1	25,1	7,1	173,0	117,8	27,7	6,2	166,2	117,4	30,6	5,4	158,5	116,2	34,0	4,7	150,2	113,7	37,8	4,0	139,4	108,8	42,5	3,3
	27 / 19	182,8	116,9	25,2	7,3	177,1	116,6	27,8	6,4	170,2	116,2	30,7	5,5	162,4	115,2	34,1	4,8	153,9	112,9	37,8	4,1	142,8	108,0	42,6	3,4
	28 / 20	187,1	115,5	25,2	7,4	181,4	115,2	27,8	6,5	174,3	114,9	30,8	5,7	166,2	113,8	34,2	4,9	157,4	111,3	37,9	4,2	146,6	106,6	42,7	3,4
	30 / 22	195,7	112,7	25,3	7,7	189,8	112,4	27,9	6,8	182,4	112,2	30,9	5,9	173,7	110,9	34,3	5,1	164,4	108,1	38,1	4,3	153,9	103,9	42,9	3,6
26000 m ³ /h	22 / 16	169,4	113,3	25,1	6,7	164,1	112,9	27,6	5,9	157,9	112,4	30,5	5,2	151,0	110,6	33,8	4,5	143,6	106,9	37,6	3,8	133,6	102,1	42,3	3,2
	24 / 17	176,1	119,7	25,1	7,0	170,7	119,3	27,7	6,2	164,2	118,6	30,6	5,4	156,9	116,7	34,0	4,6	149,0	113,0	37,7	4,0	138,9	108,9	42,4	3,3
	26 / 18	183,3	125,6	25,2	7,3	177,7	125,3	27,8	6,4	170,9	125,0	30,7	5,6	163,1	123,5	34,1	4,8	154,6	119,9	37,9	4,1	144,0	115,6	42,6	3,4
	27 / 19	187,6	124,3	25,2	7,4	181,9	124,0	27,8	6,5	175,0	123,8	30,8	5,7	167,1	122,4	34,2	4,9	158,4	118,8	38,0	4,2	147,7	114,2	42,7	3,5
	28 / 20	192,0	122,7	25,2	7,6	186,3	122,4	27,9	6,7	179,2	122,1	30,9	5,8	171,0	120,6	34,3	5,0	162,1	117,1	38,0	4,3	151,5	112,4	42,8	3,5
	30 / 22	200,7	119,4	25,3	7,9	194,8	119,1	27,9	7,0	187,5	118,6	31,0	6,0	178,8	117,1	34,4	5,2	169,4	113,9	38,2	4,4	159,2	108,6	43,0	3,7
34000 m ³ /h	22 / 16	176,3	123,9	25,1	7,0	171,1	123,2	27,7	6,2	165,0	122,6	30,6	5,4	158,3	120,5	34,0	4,7	150,8	116,0	37,8	4,0	139,7	110,6	42,5	3,3
	24 / 17	183,4	131,8	25,2	7,3	177,9	131,3	27,8	6,4	171,5	130,9	30,7	5,6	164,2	129,4	34,1	4,8	156,1	125,3	37,9	4,1	145,4	118,2	42,6	3,4
	26 / 18	191,2	139,3	25,2	7,6	185,5	138,8	27,9	6,6	178,8	138,2	30,9	5,8	171,2	136,7	34,3	5,0	162,8	133,7	38,1	4,3	151,5	128,0	42,8	3,5
	27 / 19	195,5	137,5	25,3	7,7	189,9	137,0	27,9	6,8	183,2	136,1	30,9	5,9	175,5	134,5	34,3	5,1	167,0	131,8	38,2	4,4	155,5	126,8	42,9	3,6
	28 / 20	200,0	135,5	25,3	7,9	194,3	135,0	27,9	7,0	187,4	134,1	31,0	6,0	179,6	132,4	34,4	5,2	170,8	129,6	38,2	4,5	158,8	125,0	43,0	3,7
	30 / 22	208,8	131,3	25,3	8,3	202,9	130,8	28,0	7,2	195,7	130,1	31,1	6,3	187,5	128,2	34,6	5,4	178,4	125,0	38,4	4,6	165,6	121,0	43,2	3,8

Heating performance with full recirculation

Airflow	Ta (°C) DB	Water leaving temperature °C D.B./W.B.																	
		6			8			10			12			14			16		
		kWt	kWe	COP	kWt	kWe	COP	kWt	kWe	COP	kWt	kWe	COP	kWt	kWe	COP	kWt	kWe	COP
22000 m ³ /h	10	178,4	31,2	5,72	187,5	32,2	5,82	195,6	33,2	5,89	201,3	33,8	5,96	210,2	34,9	6,02	219,9	36,2	6,07
	15	173,9	34,4	5,06	182,3	35,4	5,15	189,6	36,5	5,19	194,9	37,2	5,24	203,0	38,3	5,30	211,9	39,5	5,36
	18	170,3	36,5	4,67	178,5	37,5	4,76	185,2	38,6	4,80	190,3	39,3	4,84	198,1	40,4	4,90	206,7	41,6	4,97
	20	-	-	-	176,0	38,9	4,52	182,2	40,0	4,56	187,2	40,7	4,60	194,9	41,8	4,66	203,1	43,1	4,71
	22	-	-	-	-	-	-	179,2	41,6	4,31	184,1	42,3	4,35	191,7	43,5	4,41	200,0	44,8	4,46
	25	-	-	-	-	-	-	174,7	43,8	3,99	179,5	44,7	4,02	186,9	46,0	4,06	195,4	47,5	4,11
26000 m ³ /h	10	180	29,6	6,08	189,4	30,6	6,19	198,1	31,4	6,31	204,0	32,0	6,38	213,5	33,0	6,47	223,9	34,2	6,55
	15	176,2	32,8	5,37	184,9	33,8	5,47	192,9	34,7	5,56	198,4	35,3	5,62	207,2	36,3	5,71	216,8	37,4	5,80
	18	173	34,8	4,97	181,6	35,7	5,09	189,0	36,7	5,15	194,3	37,3	5,21	202,7	38,3	5,29	211,8	39,5	5,36
	20	170,8	36,1	4,73	179,3	37,1	4,83	186,3	38,0	4,90	191,6	38,7	4,95	199,7	39,7	5,03	208,4	40,9	5,10
	22	-	-	-	176,7	38,6	4,58	183,3	39,5	4,64	188,3	40,2	4,68	196,3	41,3	4,75	205,0	42,5	4,82
	25	-	-	-	-	-	-	178,7	41,8	4,28	183,5	42,6	4,31	191,3	43,6	4,39	199,8	44,9	4,45
34000 m ³ /h	10	182,3	27,3	6,68	192,4	28,0	6,87	201,6	28,8	7,00	207,9	29,3	7,10	217,8	30,1	7,24	229,3	31,0	7,40
	15	179,5	30,4	5,90	188,6	31,2	6,04	197,5	31,9	6,19	203,7	32,5	6,27	213,1	33,2	6,42	223,5	34,2	6,54
	18	176,7	32,3	5,47	185,8	33,1	5,61	194,2	33,8	5,75	200,3	34,4	5,82	209,2	35,3	5,93	219,1	36,3	6,04
	20	174,8	33,6	5,20	183,9	34,4	5,35	192,1	35,1	5,47	198,0	35,8	5,53	206,6	36,6	5,64	216,1	37,6	5,75
	22	172,7	35	4,93	181,6	35,8	5,07	189,3	36,5	5,19	195,0	37,2	5,24	203,4	38,1	5,34	212,7	39,1	5,44
	25	-	-	-	178,3	37,8	4,72	185,1	38,6	4,80	190,5	39,3	4,85	198,8	40,2	4,95	207,5	41,2	5,04

Ta = Indoor air temperature D.B./W.B

DB = Dry bulb

WB = Wet bulb

kWf = Cooling capacity in kW

kWs = Sensible cooling capacity (kW)

kWe = Compressor power input in kW

kWt = Heating capacity (kW)

EER referred only to compressors

COP referred only to compressors

The fan motor heating is not considered

Size 54.4 CAK configuration

Cooling performance with full recirculation

Airflow	Ta °C DB/WB	Water leaving temperature °C D.B/W.B.																							
		25				30				35				40				45				50			
		kWf	kWs	kWe	EER	kWf	kWs	kWe	EER	kWf	kWs	kWe	EER	kWf	kWs	kWe	EER	kWf	kWs	kWe	EER	kWf	kWs	kWe	EER
22000 m³/h	22 / 16	172,6	111,9	27,0	6,4	167,2	111,6	29,6	5,6	161,1	111,0	32,7	4,9	154,2	109,1	36,3	4,2	146,6	105,4	40,4	3,6	137,1	99,4	45,6	3,0
	24 / 17	179,5	117,5	27,1	6,6	173,9	117,2	29,7	5,9	167,0	116,8	32,8	5,1	159,2	115,5	36,4	4,4	151,1	112,4	40,5	3,7	140,5	106,4	45,7	3,1
	26 / 18	186,7	122,7	27,1	6,9	181,0	122,4	29,8	6,1	173,8	122,0	32,9	5,3	165,2	121,5	36,5	4,5	155,8	119,9	40,6	3,8	145,4	113,3	45,8	3,2
	27 / 19	191,1	121,6	27,2	7,0	185,3	121,3	29,8	6,2	178,0	120,9	33,0	5,4	169,1	120,5	36,6	4,6	159,5	119,2	40,7	3,9	149,3	112,4	45,9	3,3
	28 / 20	195,5	120,1	27,3	7,2	189,6	119,8	29,9	6,3	182,3	119,4	33,0	5,5	173,4	118,6	36,7	4,7	163,8	116,6	40,8	4,0	153,5	110,5	46,1	3,3
	30 / 22	204,3	117,2	27,4	7,5	198,2	117,0	30,0	6,6	190,8	116,4	33,2	5,7	182,0	114,7	36,9	4,9	172,4	111,5	41,0	4,2	162,0	106,5	46,3	3,5
29000 m³/h	22 / 16	180,5	122,5	27,1	6,7	175,4	121,8	29,7	5,9	169,1	121,1	32,8	5,2	161,6	119,5	36,5	4,4	153,2	116,3	40,6	3,8	142,3	110,2	45,8	3,1
	24 / 17	187,8	129,5	27,2	6,9	182,2	128,9	29,8	6,1	175,3	128,2	32,9	5,3	167,8	126,4	36,6	4,6	159,6	122,6	40,7	3,9	147,3	117,2	45,9	3,2
	26 / 18	195,5	135,8	27,3	7,2	189,6	135,4	29,9	6,3	182,6	135,0	33,0	5,5	174,9	133,3	36,7	4,8	166,3	129,6	40,9	4,1	153,9	124,8	46,1	3,3
	27 / 19	199,9	134,3	27,3	7,3	194,0	133,9	30,0	6,5	187,0	133,5	33,1	5,6	179,2	131,7	36,8	4,9	170,6	128,0	40,9	4,2	158,0	123,5	46,2	3,4
	28 / 20	204,4	132,5	27,4	7,5	198,4	132,1	30,0	6,6	191,4	131,5	33,2	5,8	183,4	129,7	36,9	5,0	174,1	126,4	41,0	4,2	162,2	121,5	46,3	3,5
	30 / 22	213,3	128,7	27,5	7,8	207,2	128,4	30,1	6,9	200,3	127,3	33,3	6,0	191,5	125,6	37,0	5,2	181,0	123,2	41,2	4,4	170,3	117,6	46,5	3,7
34000 m³/h	22 / 16	184,9	129,0	27,1	6,8	179,8	127,9	29,8	6,0	174,1	126,5	32,9	5,3	166,8	124,6	36,6	4,6	157,4	121,4	40,7	3,9	145,8	116,2	45,9	3,2
	24 / 17	192,4	136,8	27,2	7,1	186,7	135,5	29,9	6,2	180,0	135,1	33,0	5,5	172,6	133,6	36,7	4,7	164,3	129,1	40,8	4,0	152,4	122,9	46,0	3,3
	26 / 18	200,4	144,0	27,3	7,3	194,5	143,4	30,0	6,5	187,6	142,7	33,1	5,7	179,7	141,0	36,8	4,9	170,7	137,7	40,9	4,2	157,7	132,9	46,2	3,4
	27 / 19	204,9	142,2	27,4	7,5	198,9	141,9	30,0	6,6	192,0	140,8	33,2	5,8	184,1	138,8	36,9	5,0	174,8	136,0	41,0	4,3	161,4	131,9	46,2	3,5
	28 / 20	209,4	140,1	27,4	7,6	203,5	139,7	30,1	6,8	196,5	138,6	33,3	5,9	188,2	136,8	37,0	5,1	178,5	134,2	41,1	4,3	165,9	129,4	46,4	3,6
	30 / 22	218,4	135,9	27,5	7,9	212,6	135,2	30,2	7,0	205,4	134,2	33,4	6,1	196,3	132,8	37,1	5,3	185,9	130,6	41,3	4,5	175,0	124,3	46,6	3,8

Heating performance with full recirculation

Airflow	Ta (°C) DB	Water leaving temperature °C D.B/W.B.																	
		6			8			10			12			14			16		
		kWt	kWe	COP	kWt	kWe	COP	kWt	kWe	COP	kWt	kWe	COP	kWt	kWe	COP	kWt	kWe	COP
22000 m³/h	10	189,8	35	5,42	199,5	36,2	5,51	207,6	37,3	5,57	212,9	38,1	5,59	222,3	39,2	5,67	232,2	40,6	5,72
	15	184,6	38,4	4,81	193,5	39,8	4,86	201,0	40,7	4,94	205,5	41,6	4,94	214,0	43,0	4,98	223,0	44,5	5,01
	18	180,6	40,7	4,44	188,9	42,1	4,49	196,0	43,2	4,54	201,0	44,1	4,56	209,1	45,4	4,61	217,7	46,9	4,64
	20	177,9	42,2	4,22	185,7	43,7	4,25	192,7	44,9	4,29	198,0	45,7	4,33	205,8	47,0	4,38	214,2	48,5	4,42
	22	-	-	-	182,9	45,5	4,02	189,5	46,8	4,05	195,0	47,6	4,10	202,9	48,9	4,15	211,4	50,5	4,19
	25	-	-	-	-	-	-	184,6	49,6	3,72	190,6	50,4	3,78	198,7	51,8	3,84	207,2	53,4	3,88
29000 m³/h	10	193,4	31,9	6,06	204,2	32,8	6,23	213,2	33,8	6,31	220,0	34,4	6,40	229,6	35,4	6,49	240,5	36,6	6,57
	15	189,3	35,3	5,36	198,9	36,3	5,48	207,4	37,3	5,56	214,0	37,9	5,65	222,6	39,0	5,71	232,5	40,2	5,78
	18	186,1	37,5	4,96	194,9	38,6	5,05	203,0	39,5	5,14	208,9	40,1	5,21	217,8	41,2	5,29	227,4	42,5	5,35
	20	183,9	39,1	4,70	192,3	40,1	4,80	200,2	41,0	4,88	205,6	41,6	4,94	214,6	42,8	5,01	224,0	44,0	5,09
	22	181,1	40,6	4,46	189,5	41,7	4,54	196,9	42,6	4,62	202,4	43,3	4,67	211,0	44,4	4,75	220,2	45,7	4,82
	25	-	-	-	185,3	44,0	4,21	192,0	45,0	4,27	197,6	45,8	4,31	205,6	47,0	4,37	214,5	48,3	4,44
34000 m³/h	10	195,4	30,3	6,45	205,5	31,2	6,59	215,8	32,1	6,72	222,2	32,7	6,80	232,9	33,6	6,93	244,6	34,6	7,07
	15	191,9	33,7	5,69	201,3	34,7	5,80	210,5	35,6	5,91	216,8	36,2	5,99	226,7	37,2	6,09	237,4	38,2	6,21
	18	188,8	35,8	5,27	198,1	36,8	5,38	206,8	37,7	5,49	212,7	38,4	5,54	222,3	39,3	5,66	232,5	40,4	5,75
	20	186,7	37,1	5,03	196,0	38,2	5,13	204,4	39,1	5,23	210,0	39,8	5,28	219,3	40,7	5,39	229,3	41,8	5,49
	22	184,1	38,7	4,76	193,2	39,8	4,85	201,2	40,7	4,94	206,7	41,4	4,99	215,5	42,3	5,09	225,2	43,5	5,18
	25	180,1	41,1	4,38	188,9	42,0	4,50	196,5	43,0	4,57	201,8	43,7	4,62	209,8	44,8	4,68	219,1	46,0	4,76

Ta = Indoor air temperature D.B/W.B
 DB = Dry bulb
 WB = Wet bulb
 kWf = Cooling capacity in kW
 kWs = Sensible cooling capacity (kW)
 kWe = Compressor power input in kW
 kWt = Heating capacity (kW)
 EER referred only to compressors
 COP referred only to compressors
 The fan motor heating is not considered

Size 60.4 CAK configuration

Cooling performance with full recirculation

Airflow	Ta °C DB/WB	Water leaving temperature °C D.B./W.B.																							
		25				30				35				40				45				50			
		kWf	kWs	kWe	EER	kWf	kWs	kWe	EER	kWf	kWs	kWe	EER	kWf	kWs	kWe	EER	kWf	kWs	kWe	EER	kWf	kWs	kWe	EER
29000 m³/h	22 / 16	207,5	124,4	31,7	6,5	200,1	124,0	35,3	5,7	190,8	123,6	39,3	4,9	180,1	123,1	43,4	4,1	168,1	122,2	47,7	3,5	155,9	119,7	52,5	3,0
	24 / 17	215,9	131,0	31,7	6,8	208,1	130,6	35,5	5,9	198,6	130,2	39,5	5,0	187,5	129,4	43,6	4,3	175,0	128,1	48,0	3,6	161,4	127,4	52,7	3,1
	26 / 18	224,7	138,0	31,7	7,1	216,6	137,0	35,6	6,1	206,7	136,4	39,7	5,2	195,2	135,7	43,9	4,4	182,0	134,8	48,2	3,8	167,4	134,8	53,0	3,2
	27 / 19	230,1	137,2	31,7	7,3	221,8	136,0	35,6	6,2	211,7	135,3	39,8	5,3	200,0	134,6	44,0	4,5	186,7	133,6	48,4	3,9	171,8	133,6	53,2	3,2
	28 / 20	235,6	135,4	31,6	7,5	227,2	134,6	35,7	6,4	216,8	134,0	39,9	5,4	204,9	133,2	44,1	4,6	191,4	131,9	48,5	3,9	176,9	130,4	53,4	3,3
	30 / 22	246,7	131,9	31,5	7,8	237,8	131,6	35,7	6,7	227,0	131,3	40,1	5,7	214,5	130,5	44,4	4,8	200,8	128,5	48,9	4,1	187,0	124,0	53,8	3,5
33000 m³/h	22 / 16	211,2	130,4	31,7	6,7	203,6	130,0	35,4	5,8	194,3	129,5	39,4	4,9	183,6	128,9	43,5	4,2	171,8	127,5	47,8	3,6	160,4	123,1	52,7	3,0
	24 / 17	219,8	137,7	31,7	6,9	211,9	137,3	35,5	6,0	202,2	136,9	39,6	5,1	190,9	136,0	43,7	4,4	178,4	134,5	48,1	3,7	166,0	131,3	52,9	3,1
	26 / 18	228,9	145,0	31,6	7,2	220,6	144,4	35,6	6,2	210,6	143,9	39,8	5,3	199,0	143,0	44,0	4,5	186,0	141,6	48,3	3,9	171,9	140,2	53,2	3,2
	27 / 19	234,3	143,9	31,6	7,4	225,9	143,1	35,7	6,3	215,6	142,6	39,9	5,4	204,0	141,6	44,1	4,6	191,0	140,0	48,5	3,9	176,3	138,9	53,3	3,3
	28 / 20	239,9	142,1	31,6	7,6	231,3	141,5	35,7	6,5	220,8	141,1	40,0	5,5	208,8	140,1	44,2	4,7	195,6	138,3	48,7	4,0	181,2	136,3	53,6	3,4
	30 / 22	251,0	138,5	31,4	8,0	242,0	138,2	35,7	6,8	231,0	137,9	40,2	5,7	218,4	137,0	44,5	4,9	204,6	134,9	49,0	4,2	190,7	131,1	54,0	3,5
47000 m³/h	22 / 16	221,8	148,9	31,7	7,0	213,8	148,5	35,5	6,0	204,4	147,6	39,7	5,1	194,4	145,2	43,8	4,4	183,6	141,3	48,3	3,8	170,6	137,4	53,1	3,2
	24 / 17	231,1	158,8	31,6	7,3	222,8	158,4	35,6	6,3	212,9	157,8	39,8	5,3	201,7	155,8	44,1	4,6	189,2	152,6	48,4	3,9	176,0	150,4	53,3	3,3
	26 / 18	241,1	168,3	31,6	7,6	232,4	167,9	35,7	6,5	221,9	167,5	40,0	5,5	210,1	166,0	44,3	4,7	197,2	163,3	48,7	4,0	183,0	161,2	53,6	3,4
	27 / 19	246,7	166,4	31,5	7,8	237,8	166,0	35,7	6,7	227,0	165,6	40,1	5,7	215,1	164,2	44,4	4,8	202,4	161,4	48,9	4,1	187,9	158,8	53,8	3,5
	28 / 20	252,4	164,1	31,4	8,0	243,3	163,7	35,7	6,8	232,3	163,3	40,2	5,8	220,3	161,9	44,5	5,0	207,6	159,0	49,1	4,2	193,5	154,9	54,1	3,6
	30 / 22	263,5	159,3	31,3	8,4	254,0	159,0	35,8	7,1	242,8	158,4	40,3	6,0	230,5	157,2	44,8	5,1	217,5	154,4	49,4	4,4	204,4	147,2	54,5	3,8

Heating performance with full recirculation

Airflow	Ta (°C) DB	Water leaving temperature °C D.B./W.B.																	
		6			8			10			12			14			16		
		kWt	kWe	COP	kWt	kWe	COP	kWt	kWe	COP	kWt	kWe	COP	kWt	kWe	COP	kWt	kWe	COP
29000 m³/h	10	213,2	39,4	5,41	223,4	40,5	5,52	235,6	42,1	5,60	240,3	42,4	5,67	247,3	43,5	5,69	258,2	44,9	5,75
	15	207,9	42,5	4,89	217,4	44,0	4,94	229,0	45,4	5,04	232,7	46,1	5,05	239,6	47,1	5,09	249,6	48,6	5,14
	18	203,5	45,2	4,50	212,5	46,6	4,56	223,4	48,0	4,65	227,2	48,5	4,68	233,7	49,6	4,71	243,6	51,2	4,76
	20	200,7	46,9	4,28	209,3	48,3	4,33	219,6	49,7	4,42	223,5	50,1	4,46	229,8	51,3	4,48	239,7	53,0	4,52
	22	197,3	48,8	4,04	205,8	50,0	4,12	216,1	51,6	4,19	219,7	52,1	4,22	226,0	53,4	4,23	236,2	55,0	4,29
	25	-	-	-	-	-	-	210,7	54,3	3,88	214,0	55,1	3,88	220,4	56,5	3,90	230,9	58,2	3,97
33000 m³/h	10	214,9	37,7	5,70	225,7	38,8	5,82	238,6	40,1	5,95	243,0	40,5	6,00	250,5	41,5	6,04	262,1	42,7	6,14
	15	210,3	41,1	5,12	220,3	42,5	5,18	232,1	43,7	5,31	235,8	44,4	5,31	243,1	45,3	5,37	253,9	46,7	5,44
	18	206,1	43,6	4,73	215,7	45,0	4,79	226,7	46,3	4,90	230,8	46,8	4,93	237,6	47,8	4,97	248,1	49,3	5,03
	20	203,4	45,4	4,48	212,6	46,6	4,56	223,1	48,1	4,64	227,5	48,4	4,70	234,0	49,5	4,73	244,3	51,0	4,79
	22	200,2	47,1	4,25	209,2	48,3	4,33	219,6	49,8	4,41	223,7	50,2	4,46	230,2	51,3	4,49	240,6	52,9	4,55
	25	-	-	-	204,1	50,9	4,01	214,3	52,4	4,09	218,0	53,0	4,11	224,6	54,2	4,14	235,0	55,8	4,21
47000 m³/h	10	219,2	33,5	6,54	231,2	34,3	6,74	245,3	35,1	6,99	250,4	35,3	7,09	258,6	36,0	7,18	271,4	37,0	7,34
	15	215,9	37,1	5,82	227,3	38,1	5,97	240,2	39,1	6,14	244,6	39,7	6,16	252,7	40,5	6,24	265,0	41,6	6,37
	18	212,7	39,5	5,38	224,0	40,3	5,56	236,2	41,5	5,69	240,7	41,9	5,74	248,6	42,8	5,81	260,4	43,9	5,93
	20	210,6	41,1	5,12	221,9	41,8	5,31	233,6	43,0	5,43	238,1	43,5	5,47	245,8	44,3	5,55	257,3	45,5	5,65
	22	208,2	42,6	4,89	218,8	43,4	5,04	230,3	44,7	5,15	234,5	45,1	5,20	242,2	46,0	5,27	253,5	47,1	5,38
	25	204,6	44,9	4,56	214,1	45,9	4,66	225,2	47,1	4,78	229,0	47,6	4,81	236,8	48,4	4,89	247,9	49,6	5,00

Ta = Indoor air temperature D.B./W.B.
 DB = Dry bulb
 WB = Wet bulb
 kWf = Cooling capacity in kW
 kWs = Sensible cooling capacity (kW)
 kWe = Compressor power input in kW
 kWt = Heating capacity (kW)
 EER referred only to compressors
 COP referred only to compressors
 The fan motor heating is not considered

Size 70.4 CAK configuration

Cooling performance with full recirculation

Airflow	Ta °C DB/ WB	Water leaving temperature °C D.B./W.B.																							
		25				30				35				40				45				50			
		kWf	kWs	kWe	EER	kWf	kWs	kWe	EER	kWf	kWs	kWe	EER	kWf	kWs	kWe	EER	kWf	kWs	kWe	EER	kWf	kWs	kWe	EER
29000 m³/h	22 / 16	240,7	133,7	36,6	6,6	231,5	133,2	40,3	5,7	220,8	132,6	44,5	5,0	208,1	131,9	49,0	4,2	193,3	130,9	54,2	3,6	177,2	128,7	60,1	2,9
	24 / 17	250,1	140,6	36,7	6,8	240,6	140,1	40,5	5,9	229,5	139,6	44,7	5,1	216,3	138,9	49,3	4,4	200,9	137,8	54,4	3,7	184,2	135,8	60,3	3,1
	26 / 18	260,3	147,1	36,9	7,1	250,5	146,7	40,7	6,2	238,9	146,2	45,0	5,3	225,2	145,5	49,6	4,5	209,1	144,6	54,7	3,8	191,7	142,7	60,6	3,2
	27 / 19	266,9	146,2	37,0	7,2	256,8	145,8	40,8	6,3	245,0	145,3	45,1	5,4	230,9	144,7	49,8	4,6	214,5	143,7	54,9	3,9	197,0	141,7	60,8	3,2
	28 / 20	273,8	145,1	37,0	7,4	263,5	144,7	41,0	6,4	251,4	144,2	45,3	5,5	237,0	143,6	49,9	4,7	220,2	142,6	55,1	4,0	202,6	140,3	61,0	3,3
	30 / 22	287,6	142,8	37,2	7,7	276,8	142,4	41,2	6,7	264,1	141,9	45,5	5,8	249,0	141,3	50,3	5,0	231,4	140,2	55,5	4,2	213,8	137,3	61,4	3,5
37000 m³/h	22 / 16	250,5	148,0	36,7	6,8	240,9	147,5	40,5	5,9	229,8	146,9	44,7	5,1	216,6	146,1	49,3	4,4	201,4	144,7	54,4	3,7	185,7	141,0	60,4	3,1
	24 / 17	260,5	156,5	36,9	7,1	250,6	156,0	40,7	6,2	239,0	155,5	45,0	5,3	225,2	154,7	49,6	4,5	209,5	153,3	54,7	3,8	193,6	149,6	60,6	3,2
	26 / 18	271,4	164,7	37,0	7,3	261,1	164,3	40,9	6,4	249,1	163,8	45,2	5,5	234,8	163,0	49,9	4,7	218,3	161,8	55,0	4,0	201,4	159,4	60,9	3,3
	27 / 19	278,2	163,5	37,1	7,5	267,7	163,1	41,0	6,5	255,4	162,6	45,4	5,6	240,8	161,8	50,0	4,8	224,1	160,5	55,3	4,1	207,1	158,2	61,1	3,4
	28 / 20	285,2	161,9	37,2	7,7	274,5	161,5	41,1	6,7	261,8	161,0	45,5	5,8	246,9	160,3	50,2	4,9	229,7	159,0	55,4	4,1	212,3	156,3	61,4	3,5
	30 / 22	299,1	158,7	37,3	8,0	287,9	158,4	41,4	7,0	274,7	157,9	45,8	6,0	258,9	157,2	50,5	5,1	240,7	155,8	55,8	4,3	222,5	152,8	61,8	3,6
47000 m³/h	22 / 16	259,6	163,3	36,9	7,0	249,7	162,8	40,7	6,1	238,1	162,2	44,9	5,3	224,5	161,2	49,6	4,5	209,4	158,9	54,7	3,8	194,5	153,5	60,7	3,2
	24 / 17	270,2	174,0	37,0	7,3	260,0	173,5	40,9	6,4	247,9	172,9	45,2	5,5	233,8	172,1	49,9	4,7	217,6	170,4	55,0	4,0	200,9	166,7	60,9	3,3
	26 / 18	281,9	184,3	37,1	7,6	271,2	183,8	41,1	6,6	258,7	183,3	45,4	5,7	243,8	182,6	50,1	4,9	226,8	180,8	55,3	4,1	210,2	175,6	61,3	3,4
	27 / 19	288,9	182,6	37,2	7,8	278,0	182,2	41,2	6,7	265,1	181,7	45,6	5,8	249,8	180,9	50,3	5,0	232,5	179,0	55,5	4,2	216,3	172,7	61,5	3,5
	28 / 20	295,9	180,5	37,3	7,9	284,8	180,1	41,3	6,9	271,6	179,6	45,7	5,9	256,1	178,9	50,4	5,1	238,4	176,8	55,7	4,3	221,8	170,8	61,7	3,6
	30 / 22	309,8	176,2	37,4	8,3	298,3	175,9	41,5	7,2	284,5	175,4	46,0	6,2	268,4	174,5	50,8	5,3	250,3	172,3	56,1	4,5	233,1	166,5	62,2	3,7

Heating performance with full recirculation

Airflow	Ta (°C) DB	Water leaving temperature °C D.B./W.B.																	
		6			8			10			12			14			16		
		kWt	kWe	COP	kWt	kWe	COP	kWt	kWe	COP	kWt	kWe	COP	kWt	kWe	COP	kWt	kWe	COP
29000 m³/h	10	243,6	45,4	5,37	255,0	47,1	5,41	268,7	48,7	5,52	273,9	49,0	5,59	282,8	50,2	5,63	295,8	51,9	5,70
	15	237,3	49,3	4,81	248,1	50,9	4,87	260,8	52,7	4,95	264,4	53,5	4,94	273,1	54,6	5,00	285,4	56,4	5,06
	18	232	52,4	4,43	242,1	54,0	4,48	254,1	55,9	4,55	258,2	56,4	4,58	266,3	57,6	4,62	278,1	59,7	4,66
	20	-	-	-	238,1	56,1	4,24	249,7	57,9	4,31	254,1	58,3	4,36	261,8	59,6	4,39	273,2	61,9	4,41
	22	-	-	-	-	-	-	245,2	60,8	4,03	249,8	61,3	4,08	257,7	62,7	4,11	269,4	64,9	4,15
	25	-	-	-	-	-	-	-	-	-	243,2	65,9	3,69	251,7	67,3	3,74	-	-	-
37000 m³/h	10	248,7	41,4	6,01	261,9	42,7	6,13	277,9	43,6	6,37	282,7	44,3	6,38	292,1	45,2	6,46	307,1	46,6	6,59
	15	243,4	45,3	5,37	255,6	46,7	5,47	269,3	48,4	5,56	274,2	48,9	5,61	283,4	49,8	5,69	297,5	51,3	5,80
	18	238,5	48,4	4,93	250,3	49,6	5,05	263,3	51,3	5,13	268,1	51,7	5,19	276,9	52,7	5,25	290,3	54,3	5,35
	20	235,3	50,5	4,66	246,8	51,5	4,79	259,3	53,2	4,87	264,1	53,7	4,92	272,6	54,6	4,99	285,5	56,3	5,07
	22	231,9	52,4	4,43	243,0	53,6	4,53	255,2	55,3	4,61	259,8	55,8	4,66	268,0	56,9	4,71	280,5	58,6	4,79
	25	-	-	-	237,4	56,8	4,18	248,9	58,6	4,25	253,3	59,1	4,29	261,1	60,2	4,34	273,1	62,2	4,39
47000 m³/h	10	253,3	38,1	6,65	266,6	39,2	6,80	283,1	40,3	7,02	288,5	40,7	7,09	298,7	41,2	7,25	314,4	42,3	7,43
	15	248,3	42,1	5,90	261,0	43,3	6,03	276,3	44,8	6,17	281,2	45,1	6,24	291,2	45,9	6,34	306,3	47,2	6,49
	18	244,2	44,9	5,44	257,0	45,7	5,62	271,6	47,1	5,77	277,0	47,4	5,84	286,1	48,3	5,92	300,7	49,7	6,05
	20	241,5	46,7	5,17	254,4	47,3	5,38	268,5	48,6	5,52	274,1	48,9	5,61	282,7	49,9	5,67	296,9	51,3	5,79
	22	238,6	48,5	4,92	250,9	49,2	5,10	264,7	50,6	5,23	269,9	50,9	5,30	278,4	51,9	5,36	292,2	53,4	5,47
	25	234,3	51,1	4,59	245,7	52,0	4,73	259,1	53,5	4,84	263,5	53,9	4,89	272,1	54,9	4,96	285,2	56,4	5,06

Ta = Indoor air temperature D.B./W.B
 DB = Dry bulb
 WB = Wet bulb
 kWf = Cooling capacity in kW
 kWs = Sensible cooling capacity (kW)
 kWe = Compressor power input in kW
 kWt = Heating capacity (kW)
 EER referred only to compressors
 COP referred only to compressors
 The fan motor heating is not considered

Size 80.4 CAK configuration

Cooling performance with full recirculation

Airflow	Ta °C DB/WB	Water leaving temperature °C D.B./W.B.																							
		25				30				35				40				45				50			
		kWf	kWs	kWe	EER	kWf	kWs	kWe	EER	kWf	kWs	kWe	EER	kWf	kWs	kWe	EER	kWf	kWs	kWe	EER	kWf	kWs	kWe	EER
29000 m³/h	22 / 16	259,1	143,1	42,2	6,1	249,5	142,8	46,5	5,4	238,0	142,3	51,3	4,6	224,2	141,6	56,6	4,0	208,3	140,1	62,5	3,3	192,6	136,0	69,1	2,8
	24 / 17	269,3	150,1	42,4	6,4	259,3	149,8	46,7	5,6	247,4	149,3	51,5	4,8	233,0	148,6	56,8	4,1	216,0	147,6	62,7	3,4	197,5	145,9	69,3	2,8
	26 / 18	280,0	156,6	42,6	6,6	269,7	156,3	46,9	5,8	257,3	155,8	51,8	5,0	242,4	155,1	57,1	4,2	224,8	154,0	63,0	3,6	206,4	151,4	69,6	3,0
	27 / 19	286,9	155,7	42,7	6,7	276,4	155,4	47,1	5,9	263,7	154,9	52,0	5,1	248,4	154,2	57,3	4,3	230,6	153,0	63,2	3,6	212,4	149,8	69,9	3,0
	28 / 20	293,9	154,5	42,8	6,9	283,2	154,2	47,2	6,0	270,3	153,7	52,1	5,2	254,7	153,1	57,5	4,4	236,4	151,7	63,4	3,7	217,6	148,0	70,1	3,1
	30 / 22	308,0	151,9	43,1	7,1	296,8	151,7	47,5	6,2	283,3	151,3	52,4	5,4	267,1	150,6	57,8	4,6	248,0	149,0	63,8	3,9	228,2	144,3	70,5	3,2
44000 m³/h	22 / 16	277,8	169,6	42,5	6,5	267,5	169,2	46,9	5,7	255,2	168,7	51,7	4,9	240,8	167,4	57,1	4,2	224,7	164,5	63,0	3,6	208,7	158,6	69,7	3,0
	24 / 17	288,9	179,2	42,7	6,8	278,3	178,9	47,1	5,9	265,5	178,4	52,0	5,1	250,5	177,2	57,3	4,4	233,7	174,5	63,3	3,7	217,2	168,8	70,1	3,1
	26 / 18	300,9	188,5	42,9	7,0	289,9	188,2	47,3	6,1	276,6	187,8	52,3	5,3	260,8	186,9	57,6	4,5	242,8	184,6	63,6	3,8	225,3	178,4	70,4	3,2
	27 / 19	308,0	186,9	43,0	7,2	296,8	186,6	47,5	6,2	283,2	186,2	52,4	5,4	267,0	185,3	57,8	4,6	248,6	183,0	63,8	3,9	231,0	176,2	70,6	3,3
	28 / 20	315,4	184,9	43,1	7,3	303,9	184,7	47,6	6,4	290,0	184,2	52,6	5,5	273,5	183,3	58,0	4,7	254,9	180,9	64,0	4,0	236,5	175,3	70,8	3,3
	30 / 22	329,9	180,9	43,4	7,6	317,9	180,6	47,9	6,6	303,3	180,2	52,9	5,7	286,4	179,0	58,3	4,9	267,5	176,6	64,4	4,2	247,9	172,8	71,2	3,5
47000 m³/h	22 / 16	280,8	174,3	42,6	6,6	270,4	173,9	46,9	5,8	257,9	173,4	51,8	5,0	243,4	172,0	57,1	4,3	227,3	168,9	63,1	3,6	210,8	163,2	69,8	3,0
	24 / 17	292,1	184,5	42,8	6,8	281,3	184,2	47,2	6,0	268,4	183,7	52,1	5,2	253,4	182,3	57,4	4,4	236,7	179,3	63,4	3,7	219,7	173,8	70,2	3,1
	26 / 18	304,3	194,3	43,0	7,1	293,2	194,1	47,4	6,2	279,8	193,6	52,3	5,3	263,8	192,7	57,7	4,6	245,7	190,2	63,7	3,9	228,2	183,7	70,5	3,2
	27 / 19	311,5	192,6	43,1	7,2	300,1	192,3	47,5	6,3	286,4	191,9	52,5	5,5	270,1	191,0	57,9	4,7	251,7	188,4	63,9	3,9	234,1	181,3	70,7	3,3
	28 / 20	318,9	190,5	43,2	7,4	307,2	190,2	47,7	6,4	293,2	189,8	52,6	5,6	276,7	188,8	58,0	4,8	258,0	186,2	64,1	4,0	239,6	180,6	70,9	3,4
	30 / 22	333,4	186,1	43,4	7,7	321,3	185,8	47,9	6,7	306,5	185,4	53,0	5,8	289,7	184,0	58,4	5,0	270,9	181,4	64,5	4,2	251,2	178,3	71,3	3,5

Heating performance with full recirculation

Airflow	Ta (°C) DB	Water leaving temperature °C D.B./W.B.																	
		6			8			10			12			14			16		
		kWt	kWe	COP	kWt	kWe	COP	kWt	kWe	COP	kWt	kWe	COP	kWt	kWe	COP	kWt	kWe	COP
29000 m³/h	10	273	55,2	4,9	285,0	57,3	5,0	300,0	59,2	5,1	304,6	60,0	5,1	313,0	61,1	5,1	325,9	63,4	5,1
	15	263	61,1	4,3	274,6	62,6	4,4	288,3	64,6	4,5	292,6	65,3	4,5	301,3	66,7	4,5	313,7	68,9	4,6
	18	257,2	64,7	4,0	268,4	66,2	4,1	280,7	68,6	4,1	284,7	69,5	4,1	292,7	71,3	4,1	306,3	74,0	4,1
	20	253,3	67,1	3,8	264,2	68,6	3,9	275,7	71,3	3,9	279,4	72,2	3,9	287,0	74,3	3,9	301,4	77,3	3,9
	22	249,8	70,1	3,6	260,6	72,1	3,6	272,1	74,8	3,6	275,8	75,7	3,6	283,4	77,8	3,6	297,8	80,8	3,7
	25	-	-	-	255,2	77,4	3,3	266,7	80,1	3,3	270,5	80,9	3,3	278,0	83,0	3,3	-	-	-
44000 m³/h	10	283,4	47	6,0	298,1	48,4	6,2	315,6	50,2	6,3	321,1	50,8	6,3	330,8	51,7	6,4	346,8	53,2	6,5
	15	277,5	51,6	5,4	291,2	53,4	5,5	307,8	54,9	5,6	312,8	55,6	5,6	322,5	56,5	5,7	337,6	58,2	5,8
	18	272,7	55	5,0	285,8	56,7	5,0	301,4	58,3	5,2	306,5	58,8	5,2	315,6	59,8	5,3	329,8	61,5	5,4
	20	269,5	57,3	4,7	282,2	58,9	4,8	297,2	60,5	4,9	302,3	61,0	5,0	311,0	62,0	5,0	324,6	63,7	5,1
	22	265,7	59,6	4,5	277,9	61,1	4,5	292,3	62,7	4,7	297,2	63,3	4,7	305,6	64,4	4,7	319,2	66,3	4,8
	25	259,9	63	4,1	271,5	64,4	4,2	285,1	66,1	4,3	289,4	66,7	4,3	297,7	68,1	4,4	311,1	70,2	4,4
47000 m³/h	10	285,1	45,7	6,2	299,8	47,0	6,4	317,9	48,8	6,5	323,4	49,3	6,6	333,1	50,3	6,6	349,6	51,6	6,8
	15	279	50,4	5,5	293,1	52,0	5,6	310,0	53,7	5,8	315,5	54,1	5,8	325,5	55,1	5,9	341,3	56,7	6,0
	18	274,5	53,7	5,1	288,0	55,4	5,2	304,1	57,0	5,3	309,4	57,5	5,4	318,7	58,4	5,5	333,5	59,9	5,6
	20	271,5	56	4,8	284,6	57,6	4,9	300,2	59,1	5,1	305,3	59,7	5,1	314,2	60,5	5,2	328,3	62,0	5,3
	22	267,7	58,2	4,6	280,5	59,7	4,7	295,5	61,3	4,8	300,2	61,8	4,9	308,9	62,8	4,9	322,9	64,5	5,0
	25	262,1	61,7	4,2	274,3	63,0	4,4	288,5	64,4	4,5	292,6	65,0	4,5	301,0	66,3	4,5	314,7	68,1	4,6

Ta = Indoor air temperature D.B./W.B

DB = Dry bulb

WB = Wet bulb

kWf = Cooling capacity in kW

kWs = Sensible cooling capacity (kW)

kWe = Compressor power input in kW

kWt = Heating capacity (kW)

EER referred only to compressors

COP referred only to compressors

The fan motor heating is not considered

Size 90.4 CAK configuration

Cooling performance with full recirculation

Airflow	Ta °C DB/WB	Water leaving temperature °C D.B./W.B.																							
		25				30				35				40				45				50			
		kWf	kWs	kWe	EER	kWf	kWs	kWe	EER	kWf	kWs	kWe	EER	kWf	kWs	kWe	EER	kWf	kWs	kWe	EER	kWf	kWs	kWe	EER
38000 m³/h	22 / 16	316,7	194,7	49,8	6,4	304,7	194,2	54,7	5,6	290,4	193,4	60,4	4,8	274,6	191,4	66,5	4,1	257,9	186,9	73,4	3,5	240,9	178,7	81,4	3,0
	24 / 17	329,2	204,9	50,1	6,6	316,8	204,4	55,0	5,8	302,0	203,7	60,7	5,0	285,5	201,7	66,8	4,3	268,0	197,3	73,7	3,6	250,0	188,7	81,7	3,1
	26 / 18	342,3	214,5	50,4	6,8	329,4	214,0	55,3	6,0	314,1	213,3	61,0	5,1	296,8	211,7	67,2	4,4	278,0	208,1	74,1	3,8	258,5	201,4	82,0	3,2
	27 / 19	350,7	212,8	50,5	6,9	337,6	212,3	55,5	6,1	321,8	211,6	61,2	5,3	304,3	209,9	67,4	4,5	285,4	206,2	74,3	3,8	265,6	200,0	82,3	3,2
	28 / 20	359,5	210,8	50,7	7,1	346,1	210,3	55,8	6,2	330,0	209,6	61,5	5,4	312,1	207,7	67,6	4,6	292,8	203,6	74,6	3,9	272,7	197,4	82,6	3,3
	30 / 22	377,1	206,6	51,0	7,4	363,0	206,2	56,2	6,5	346,2	205,5	61,9	5,6	327,4	203,2	68,1	4,8	307,4	198,2	75,0	4,1	287,1	191,8	83,1	3,5
51000 m³/h	22 / 16	332,1	217,7	50,2	6,6	319,5	217,1	55,1	5,8	305,0	215,8	60,8	5,0	289,5	212,4	67,0	4,3	273,0	206,1	73,9	3,7	255,2	197,8	81,9	3,1
	24 / 17	345,4	230,6	50,4	6,9	332,4	230,1	55,4	6,0	317,4	228,8	61,1	5,2	300,6	226,1	67,3	4,5	282,1	221,2	74,2	3,8	263,1	212,8	82,2	3,2
	26 / 18	359,8	243,0	50,7	7,1	346,3	242,5	55,8	6,2	330,4	241,5	61,5	5,4	312,4	239,5	67,7	4,6	292,9	235,2	74,6	3,9	274,4	226,7	82,6	3,3
	27 / 19	368,5	240,7	50,9	7,2	354,7	240,2	56,0	6,3	338,4	239,2	61,7	5,5	320,0	237,3	67,9	4,7	300,3	233,1	74,8	4,0	282,4	224,0	82,9	3,4
	28 / 20	377,5	237,9	51,0	7,4	363,4	237,4	56,2	6,5	346,7	236,5	61,9	5,6	328,0	234,1	68,1	4,8	308,2	228,8	75,1	4,1	289,8	219,8	83,2	3,5
	30 / 22	395,3	232,2	51,3	7,7	380,6	231,7	56,5	6,7	363,0	230,9	62,3	5,8	343,7	227,4	68,6	5,0	323,7	220,1	75,6	4,3	304,1	211,8	83,8	3,6
60000 m³/h	22 / 16	340,2	231,2	50,3	6,8	327,4	230,7	55,3	5,9	312,7	229,1	61,0	5,1	297,5	224,5	67,2	4,4	281,6	216,5	74,2	3,8	262,5	210,2	82,2	3,2
	24 / 17	354,1	246,1	50,6	7,0	340,8	245,6	55,6	6,1	325,9	243,9	61,3	5,3	308,8	240,4	67,5	4,6	289,4	235,5	74,4	3,9	270,7	229,8	82,5	3,3
	26 / 18	369,1	260,5	50,9	7,3	355,3	260,0	56,0	6,3	339,2	258,8	61,7	5,5	321,3	256,0	67,9	4,7	302,0	251,1	74,9	4,0	282,1	245,3	82,9	3,4
	27 / 19	378,0	257,7	51,0	7,4	363,8	257,2	56,2	6,5	347,3	256,1	61,9	5,6	329,6	253,0	68,2	4,8	310,8	247,7	75,2	4,1	290,1	241,7	83,2	3,5
	28 / 20	387,0	254,4	51,2	7,6	372,6	253,9	56,4	6,6	355,6	252,9	62,1	5,7	337,5	249,5	68,4	4,9	318,7	243,3	75,5	4,2	298,1	236,6	83,5	3,6
	30 / 22	404,9	247,6	51,4	7,9	389,8	247,1	56,7	6,9	371,7	246,3	62,5	5,9	352,7	242,7	68,9	5,1	334,0	234,8	76,0	4,4	314,2	226,2	84,2	3,7

Heating performance with full recirculation

Airflow	Ta (°C) DB	Water leaving temperature °C D.B./W.B.																	
		6			8			10			12			14			16		
		kWt	kWe	COP	kWt	kWe	COP	kWt	kWe	COP	kWt	kWe	COP	kWt	kWe	COP	kWt	kWe	COP
38000 m³/h	10	331,4	58,1	5,70	349,2	59,6	5,86	368,2	62,2	5,92	374,5	62,4	6,00	386,0	63,8	6,05	404,4	66,0	6,13
	15	324,5	63,3	5,13	340,3	65,0	5,24	358,4	67,3	5,33	363,9	67,9	5,36	375,5	69,1	5,43	392,9	71,3	5,51
	18	318,1	67,4	4,72	332,6	69,2	4,81	350,5	71,1	4,93	355,7	71,8	4,95	365,9	73,1	5,01	382,6	75,4	5,07
	20	313,7	70,2	4,47	327,4	71,9	4,55	345,2	73,7	4,68	350,2	74,5	4,70	359,6	75,8	4,74	375,8	78,1	4,81
	22	309	72,9	4,24	322,4	74,7	4,32	339,0	76,7	4,42	343,8	77,6	4,43	353,2	79,1	4,47	369,4	81,4	4,54
	25	301,9	77	3,92	315,0	78,9	3,99	329,7	81,2	4,06	334,1	82,2	4,06	343,7	83,9	4,10	359,9	86,4	4,17
51000 m³/h	10	338,7	52,4	6,46	357,2	53,6	6,66	379,1	55,4	6,84	385,4	55,9	6,89	397,7	56,8	7,00	418,1	58,5	7,15
	15	331,9	58,1	5,71	349,2	59,4	5,88	368,9	61,6	5,99	375,4	61,8	6,07	386,9	63,1	6,13	406,1	64,9	6,26
	18	327,3	61,3	5,34	344,0	62,6	5,50	363,2	64,7	5,61	369,5	65,0	5,68	380,9	66,3	5,75	399,2	68,3	5,84
	20	324,3	63,4	5,12	340,4	64,6	5,27	359,4	66,8	5,38	365,5	67,2	5,44	376,9	68,4	5,51	394,6	70,5	5,60
	22	320,1	66	4,85	335,3	67,5	4,97	353,9	69,4	5,10	359,6	70,0	5,14	370,9	71,0	5,22	388,3	73,1	5,31
	25	313,8	69,8	4,50	327,7	71,7	4,57	345,6	73,2	4,72	350,6	74,3	4,72	361,9	75,0	4,83	378,9	76,9	4,93
60000 m³/h	10	341,7	49,5	6,90	360,3	51,1	7,05	383,1	52,6	7,28	390,0	53,0	7,36	401,8	53,9	7,45	422,7	55,5	7,62
	15	335,7	54,8	6,13	353,1	56,6	6,24	373,9	58,6	6,38	380,2	58,8	6,47	392,2	60,0	6,54	412,7	61,7	6,69
	18	331,2	58,4	5,67	348,4	59,9	5,82	368,8	61,8	5,97	374,7	62,3	6,01	386,3	63,3	6,10	406,1	64,9	6,26
	20	328,2	60,7	5,41	345,3	62,1	5,56	365,4	64,0	5,71	371,1	64,6	5,74	382,5	65,4	5,85	401,6	67,1	5,99
	22	324,3	63,3	5,12	340,7	64,6	5,27	359,9	66,7	5,40	365,6	67,2	5,44	377,3	68,0	5,55	395,9	69,7	5,68
	25	318,6	67,2	4,74	333,7	68,5	4,87	351,5	70,8	4,96	357,3	71,1	5,03	369,5	71,8	5,15	387,3	73,5	5,27

AKTa = Indoor air temperature D.B./W.B

DB = Dry bulb

WB = Wet bulb

kWf = Cooling capacity in kW

kWs = Sensible cooling capacity (kW)

kWe = Compressor power input in kW

kWt = Heating capacity (kW)

EER referred only to compressors

COP referred only to compressors

The fan motor heating is not considered

Size 100.4 CAKconfiguration

Cooling performance with full recirculation

Airflow	Ta °C DB/WB	Water leaving temperature °C D.B./W.B.																							
		25				30				35				40				45				50			
		kWf	kWs	kWe	EER	kWf	kWs	kWe	EER	kWf	kWs	kWe	EER	kWf	kWs	kWe	EER	kWf	kWs	kWe	EER	kWf	kWs	kWe	EER
38000 m³/h	22 / 16	336,6	204,3	53,9	6,2	323,7	203,5	58,7	5,5	308,7	202,5	64,5	4,8	292,4	200,4	71,2	4,1	275,2	196,3	78,7	3,5	257,4	190,4	87,4	2,9
	24 / 17	350,1	214,7	54,3	6,4	336,7	213,9	59,1	5,7	321,2	212,9	64,9	4,9	304,1	210,9	71,5	4,3	286,0	207,1	79,0	3,6	267,0	201,7	87,7	3,0
	26 / 18	364,0	224,2	54,7	6,7	350,2	223,5	59,5	5,9	334,0	222,5	65,3	5,1	316,0	220,8	71,9	4,4	296,8	217,5	79,3	3,7	277,6	212,0	88,0	3,2
	27 / 19	373,0	222,6	54,9	6,8	358,8	221,8	59,8	6,0	342,3	220,9	65,5	5,2	324,0	219,1	72,1	4,5	304,7	215,5	79,6	3,8	285,4	209,8	88,3	3,2
	28 / 20	382,2	220,5	55,2	6,9	367,7	219,8	60,0	6,1	350,8	218,9	65,8	5,3	331,9	217,2	72,4	4,6	312,2	213,6	79,8	3,9	293,8	207,1	88,6	3,3
	30 / 22	400,7	216,4	55,7	7,2	385,5	215,6	60,6	6,4	367,7	214,7	66,4	5,5	347,5	213,4	72,9	4,8	326,4	210,3	80,3	4,1	310,6	201,5	89,1	3,5
56000 m³/h	22 / 16	359,2	236,0	54,5	6,6	345,4	235,1	59,4	5,8	329,9	233,5	65,2	5,1	313,6	229,9	71,8	4,4	296,5	223,8	79,3	3,7	276,6	216,6	88,0	3,1
	24 / 17	373,8	249,9	54,9	6,8	359,6	249,1	59,8	6,0	343,5	247,4	65,6	5,2	325,9	244,0	72,2	4,5	306,9	238,1	79,6	3,9	287,6	229,5	88,3	3,3
	26 / 18	389,6	263,1	55,4	7,0	374,7	262,3	60,3	6,2	357,8	260,9	66,0	5,4	339,2	258,3	72,6	4,7	319,2	253,8	80,1	4,0	298,8	246,8	88,7	3,4
	27 / 19	398,8	260,5	55,6	7,2	383,6	259,7	60,5	6,3	366,4	258,2	66,3	5,5	347,6	255,7	72,9	4,8	327,3	251,7	80,4	4,1	306,8	245,0	89,0	3,4
	28 / 20	408,4	257,4	55,9	7,3	392,8	256,6	60,8	6,5	375,3	255,0	66,6	5,6	356,2	252,1	73,1	4,9	335,4	247,5	80,6	4,2	314,7	241,8	89,2	3,5
	30 / 22	427,4	250,9	56,4	7,6	411,1	250,2	61,3	6,7	392,9	248,6	67,1	5,9	373,3	244,6	73,7	5,1	352,0	238,6	81,2	4,3	330,4	235,1	89,8	3,7
60000 m³/h	22 / 16	363,3	242,2	54,6	6,7	349,3	241,4	59,5	5,9	333,8	239,6	65,3	5,1	317,1	236,2	71,9	4,4	299,1	230,5	79,4	3,8	278,9	222,7	88,1	3,2
	24 / 17	378,1	256,9	55,1	6,9	363,7	256,1	59,9	6,1	347,8	254,1	65,7	5,3	329,7	250,7	72,3	4,6	309,3	245,2	79,7	3,9	290,0	236,5	88,4	3,3
	26 / 18	394,3	270,9	55,5	7,1	379,2	270,1	60,4	6,3	362,2	268,5	66,2	5,5	343,4	266,2	72,7	4,7	322,6	262,5	80,2	4,0	301,4	255,2	88,8	3,4
	27 / 19	403,6	268,2	55,8	7,2	388,1	267,3	60,7	6,4	370,9	265,7	66,5	5,6	352,0	263,6	73,0	4,8	330,9	260,7	80,5	4,1	309,4	253,5	89,1	3,5
	28 / 20	413,2	264,8	56,0	7,4	397,4	264,0	60,9	6,5	379,9	262,3	66,7	5,7	360,6	259,7	73,3	4,9	339,2	255,9	80,8	4,2	318,2	249,3	89,4	3,6
	30 / 22	432,2	257,9	56,5	7,6	415,7	257,1	61,5	6,8	397,5	255,3	67,2	5,9	377,7	251,5	73,8	5,1	356,2	245,7	81,3	4,4	335,9	240,4	90,0	3,7

Heating performance with full recirculation

Airflow	Ta (°C) DB	Water leaving temperature °C D.B./W.B.																	
		6			8			10			12			14			16		
		kWt	kWe	COP	kWt	kWe	COP	kWt	kWe	COP	kWt	kWe	COP	kWt	kWe	COP	kWt	kWe	COP
38000 m³/h	10	361,3	66,1	5,47	379,4	68,0	5,58	400,3	70,4	5,69	407,1	71,5	5,69	418,9	72,7	5,76	438,8	75,2	5,84
	15	351,9	71,9	4,89	368,8	73,9	4,99	387,7	76,5	5,07	394,9	77,3	5,11	404,5	79,4	5,09	422,6	82,3	5,13
	18	345	76,2	4,53	360,3	78,4	4,60	378,5	80,9	4,68	384,8	81,9	4,70	394,7	83,8	4,71	412,4	86,8	4,75
	20	-	-	-	354,6	81,4	4,36	372,4	83,9	4,44	378,1	85,0	4,45	388,2	86,8	4,47	405,6	89,9	4,51
	22	-	-	-	-	-	-	365,8	87,7	4,17	371,5	88,9	4,18	381,7	90,9	4,20	399,1	94,2	4,24
	25	-	-	-	-	-	-	-	-	-	361,6	94,9	3,81	371,9	97,2	3,83	389,3	100,8	3,86
56000 m³/h	10	366,9	58,7	6,25	386,0	60,7	6,36	409,8	62,6	6,55	417,3	63,3	6,59	430,0	64,4	6,68	452,9	66,5	6,81
	15	359,1	64,3	5,58	377,0	66,4	5,68	399,0	68,2	5,85	405,8	69,2	5,86	418,2	70,3	5,95	440,1	72,4	6,08
	18	352,7	68,6	5,14	370,0	70,4	5,26	391,2	72,2	5,42	398,0	73,0	5,45	410,1	74,3	5,52	430,8	76,6	5,62
	20	348,5	71,5	4,87	365,3	73,0	5,00	386,0	74,9	5,15	392,9	75,5	5,20	404,7	76,9	5,26	424,7	79,3	5,36
	22	343,9	74,3	4,63	360,4	75,8	4,75	380,2	77,9	4,88	386,7	78,4	4,93	398,2	79,9	4,98	417,7	82,3	5,08
	25	-	-	-	353,1	80,1	4,41	371,4	82,2	4,52	377,4	82,9	4,55	388,4	84,4	4,60	407,3	86,8	4,69
60000 m³/h	10	375,4	56,8	6,61	395,0	58,7	6,73	419,7	60,5	6,94	427,2	61,1	6,99	440,5	62,2	7,08	464,3	64,0	7,25
	15	367,4	62,3	5,90	385,9	64,4	5,99	408,9	65,7	6,22	415,5	67,0	6,20	428,7	67,9	6,31	451,7	69,9	6,46
	18	361,1	66,4	5,44	379,0	68,1	5,57	401,4	69,6	5,77	408,4	70,4	5,80	421,0	71,7	5,87	442,6	73,9	5,99
	20	356,9	69,2	5,16	374,4	70,6	5,30	396,4	72,3	5,48	403,7	72,6	5,56	415,9	74,1	5,61	436,5	76,5	5,71
	22	352,5	71,9	4,90	369,8	73,2	5,05	390,8	75,0	5,21	397,5	75,5	5,26	409,3	77,0	5,32	429,5	79,4	5,41
	25	345,9	75,8	4,56	363,1	77,2	4,70	382,3	79,1	4,83	388,2	79,9	4,86	399,5	81,4	4,91	419,0	83,7	5,01

Ta = Indoor air temperature D.B./W.B
 DB = Dry bulb
 WB = Wet bulb
 kWf = Cooling capacity in kW
 kWs = Sensible cooling capacity (kW)
 kWe = Compressor power input in kW
 kWt = Heating capacity (kW)
 EER referred only to compressors
 COP referred only to compressors
 The fan motor heating is not considered

Size 110.4 CAK configuration

Cooling performance with full recirculation

Airflow	Ta °C DB/WB	Water leaving temperature °C D.B./W.B.																							
		25				30				35				40				45				50			
		kWf	kWs	kWe	EER	kWf	kWs	kWe	EER	kWf	kWs	kWe	EER	kWf	kWs	kWe	EER	kWf	kWs	kWe	EER	kWf	kWs	kWe	EER
38000 m³/h	22 / 16	355,0	214,1	58,6	6,1	341,8	213,4	63,9	5,3	326,5	212,5	70,4	4,6	309,3	210,7	77,7	4,0	291,1	207,1	85,9	3,4	273,8	201,3	95,3	2,9
	24 / 17	368,9	224,4	59,0	6,3	355,4	223,7	64,3	5,5	339,4	222,9	70,7	4,8	321,5	221,2	78,0	4,1	302,3	218,0	86,2	3,5	283,7	212,9	95,6	3,0
	26 / 18	383,7	234,0	59,4	6,5	369,7	233,4	64,7	5,7	353,2	232,6	71,1	5,0	334,2	231,1	78,4	4,3	313,4	228,6	86,5	3,6	292,6	225,1	95,8	3,1
	27 / 19	393,0	232,4	59,6	6,6	378,8	231,8	64,9	5,8	361,9	231,0	71,3	5,1	342,5	229,4	78,6	4,4	321,2	226,9	86,7	3,7	299,5	223,8	96,0	3,1
	28 / 20	402,5	230,3	59,9	6,7	388,0	229,7	65,1	6,0	370,7	228,9	71,5	5,2	351,0	227,2	78,8	4,5	329,7	224,1	87,0	3,8	307,5	219,5	96,3	3,2
	30 / 22	421,4	225,9	60,4	7,0	406,2	225,3	65,6	6,2	388,1	224,5	72,0	5,4	368,0	222,6	79,2	4,6	346,6	218,3	87,4	4,0	323,6	210,7	96,8	3,3
60000 m³/h	22 / 16	384,4	253,3	59,4	6,5	370,3	252,6	64,7	5,7	354,3	251,0	71,1	5,0	337,2	247,7	78,4	4,3	319,3	242,0	86,7	3,7	298,9	233,1	96,0	3,1
	24 / 17	400,2	267,9	59,8	6,7	385,6	267,2	65,1	5,9	369,0	265,6	71,5	5,2	350,2	263,5	78,8	4,4	329,4	259,7	87,0	3,8	308,6	248,5	96,3	3,2
	26 / 18	416,9	281,4	60,2	6,9	401,7	280,8	65,5	6,1	383,9	279,8	71,9	5,3	364,4	277,3	79,1	4,6	344,1	272,4	87,4	3,9	322,9	265,2	96,8	3,3
	27 / 19	426,3	278,5	60,5	7,0	410,9	277,9	65,8	6,2	392,5	277,0	72,1	5,4	373,0	274,0	79,4	4,7	353,3	268,2	87,6	4,0	331,7	263,0	97,1	3,4
	28 / 20	436,2	275,0	60,8	7,2	420,4	274,4	66,0	6,4	402,0	273,2	72,4	5,6	382,7	270,1	79,7	4,8	363,0	264,4	87,9	4,1	340,6	259,0	97,3	3,5
	30 / 22	455,6	267,8	61,3	7,4	439,2	267,2	66,6	6,6	420,9	265,5	72,9	5,8	402,2	261,8	80,2	5,0	382,3	256,5	88,5	4,3	357,9	251,0	97,7	3,7

Heating performance with full recirculation

Airflow	Ta (°C) DB	Water leaving temperature °C D.B./W.B.																	
		6			8			10			12			14			16		
		kWt	kWe	COP	kWt	kWe	COP	kWt	kWe	COP	kWt	kWe	COP	kWt	kWe	COP	kWt	kWe	COP
38000 m³/h	10	393,6	76,1	5,17	411,8	78,1	5,27	426,9	80,3	5,32	431,6	80,9	5,33	440,6	82,2	5,36	463,8	85,5	5,42
	15	381	83,7	4,55	397,3	85,8	4,63	410,9	88,0	4,67	414,8	88,5	4,69	423,6	89,8	4,72	445,2	93,2	4,78
	18	-	-	-	388,4	90,8	4,28	401,1	92,9	4,32	404,9	93,5	4,33	413,2	95,0	4,35	434,1	99,0	4,38
	20	-	-	-	-	-	-	394,6	96,1	4,11	398,3	96,8	4,11	406,2	98,5	4,12	426,7	102,9	4,15
	22	-	-	-	-	-	-	388,6	100,5	3,87	392,7	101,1	3,88	401,4	103,5	3,88	422,3	108,3	3,90
	25	-	-	-	-	-	-	-	-	-	-	-	-	394,1	111,1	3,55	415,5	116,5	3,57
60000 m³/h	10	409,4	65	6,30	430,6	66,5	6,48	448,8	68,8	6,52	453,8	69,2	6,56	465,0	69,9	6,65	493,5	72,6	6,80
	15	401	70,8	5,66	420,4	73,4	5,73	438,2	74,8	5,86	443,2	75,1	5,90	453,1	76,5	5,92	479,6	79,3	6,05
	18	394	75,7	5,20	412,0	78,0	5,28	428,8	79,5	5,39	434,2	79,4	5,47	443,6	80,9	5,48	468,6	83,8	5,59
	20	389,3	78,9	4,93	406,5	81,2	5,01	422,5	82,6	5,12	428,3	82,4	5,20	437,2	83,8	5,22	461,3	86,7	5,32
	22	383,7	82,2	4,67	400,8	84,1	4,77	416,3	85,6	4,86	421,6	85,4	4,94	430,3	86,9	4,95	453,5	89,9	5,04
	25	-	-	-	392,4	88,4	4,44	406,9	89,9	4,53	411,6	90,0	4,57	420,0	91,5	4,59	441,9	94,7	4,67

Ta = Indoor air temperature D.B./W.B

DB = Dry bulb

WB = Wet bulb

kWf = Cooling capacity in kW

kWs = Sensible cooling capacity (kW)

kWe = Compressor power input in kW

kWt = Heating capacity (kW)

EER referred only to compressors

COP referred only to compressors

The fan motor heating is not considered

Handling electric fan performance - Standard airflow

Available static pressure (Pa) (supply+return)		90	100	120	150	180	210	240	270	300	330	360	390	420	450	510	570	630	
49.4	Airflow	m ³ /h	26000	26000	26000	26000	26000	26000	26000	26000	26000	26000	26000	26000	26000	26000	26000	26000	-
	Airflow	l/s	7222	7222	7222	7222	7222	7222	7222	7222	7222	7222	7222	7222	7222	7222	7222	7222	-
	Fan RPM	rpm	1183	1192	1210	1236	1262	1285	1311	1337	1364	1387	1413	1439	1462	1488	1535	1585	-
	Sound pressure	dB(A)	83,2	83,2	83,1	83,4	83,7	84,0	84,4	84,6	84,6	84,6	84,6	84,7	84,7	84,7	85,0	85,7	-
	Total input	kW	2,94	3,03	3,21	3,48	3,77	4,02	4,34	4,65	4,92	5,16	5,44	5,74	6,00	6,31	6,92	7,60	-
54.4	Airflow	m ³ /h	29000	29000	29000	29000	29000	29000	29000	29000	29000	29000	29000	29000	29000	29000	29000	-	-
	Airflow	l/s	8056	8056	8056	8056	8056	8056	8056	8056	8056	8056	8056	8056	8056	8056	8056	-	-
	Fan RPM	rpm	1300	1308	1323	1347	1368	1392	1413	1436	1460	1481	1505	1526	1550	1574	1619	-	-
	Sound pressure	dB(A)	85,7	85,6	85,6	85,5	85,6	85,9	86,1	86,4	86,7	87,0	87,0	87,0	87,0	87,0	87,1	-	-
	Total input	kW	3,77	3,86	4,04	4,34	4,62	4,93	5,21	5,55	5,90	6,23	6,56	6,83	7,15	7,47	8,11	-	-
60.4	Airflow	m ³ /h	33000	33000	33000	33000	33000	33000	33000	33000	33000	33000	33000	33000	33000	33000	33000	33000	33000
	Airflow	l/s	9167	9167	9167	9167	9167	9167	9167	9167	9167	9167	9167	9167	9167	9167	9167	9167	9167
	Fan RPM	rpm	1141	1150	1166	1194	1221	1246	1274	1299	1327	1355	1379	1407	1435	1457	1507	1559	1605
	Sound pressure	dB(A)	83,3	83,3	83,4	83,8	84,1	84,5	84,8	84,8	84,8	84,8	84,8	84,9	84,9	85,1	85,8	86,5	87,2
	Total input	kW	3,60	3,72	3,91	4,28	4,64	5,00	5,40	5,72	6,04	6,44	6,76	7,16	7,56	7,92	8,72	9,68	10,52
70.4	Airflow	m ³ /h	37000	37000	37000	37000	37000	37000	37000	37000	37000	37000	37000	37000	37000	37000	37000	-	-
	Airflow	l/s	10278	10278	10278	10278	10278	10278	10278	10278	10278	10278	10278	10278	10278	10278	10278	-	-
	Fan RPM	rpm	1263	1271	1287	1311	1334	1358	1381	1405	1429	1453	1476	1500	1524	1548	1594	-	-
	Sound pressure	dB(A)	87,2	87,2	87,1	87,2	87,4	87,7	87,9	88,2	88,4	88,4	88,4	88,4	88,4	88,5	88,5	-	-
	Total input	kW	4,72	4,84	5,08	5,44	5,84	6,24	6,64	7,08	7,52	7,88	8,24	8,64	9,04	9,48	10,32	-	-
80.4	Airflow	m ³ /h	44000	44000	44000	44000	44000	44000	44000	44000	44000	-	-	-	-	-	-	-	-
	Airflow	l/s	12222	12222	12222	12222	12222	12222	12222	12222	12222	-	-	-	-	-	-	-	-
	Fan RPM	rpm	1467	1474	1488	1508	1529	1549	1569	1588	1608	1628	-	-	-	-	-	-	-
	Sound pressure	dB(A)	91,2	91,1	91,1	91,0	90,9	90,9	91,1	91,2	91,4	91,6	-	-	-	-	-	-	-
	Total input	kW	7,04	7,20	7,48	7,92	8,36	8,80	9,24	9,72	10,20	10,68	-	-	-	-	-	-	-
90.4	Airflow	m ³ /h	51000	51000	51000	51000	51000	51000	51000	51000	51000	51000	51000	51000	51000	51000	51000	51000	-
	Airflow	l/s	14167	14167	14167	14167	14167	14167	14167	14167	14167	14167	14167	14167	14167	14167	14167	14167	-
	Fan RPM	rpm	1203	1211	1228	1254	1279	1305	1331	1357	1383	1409	1434	1460	1484	1509	1558	1606	-
	Sound pressure	dB(A)	87,2	87,2	87,4	87,7	88,0	88,4	88,4	88,4	88,4	88,4	88,4	88,5	88,6	88,8	89,5	90,1	-
	Total input	kW	6,42	6,60	6,90	7,50	8,04	8,64	9,18	9,72	10,26	10,80	11,34	11,94	12,54	13,14	14,46	15,84	-
100.4	Airflow	m ³ /h	56000	56000	56000	56000	56000	56000	56000	56000	56000	56000	56000	56000	56000	56000	56000	-	-
	Airflow	l/s	15556	15556	15556	15556	15556	15556	15556	15556	15556	15556	15556	15556	15556	15556	15556	-	-
	Fan RPM	rpm	1301	1309	1325	1348	1372	1395	1418	1442	1466	1489	1513	1537	1560	1583	1628	-	-
	Sound pressure	dB(A)	89,1	89,1	89,2	89,5	89,7	90,0	90,2	90,4	90,4	90,4	90,4	90,4	90,4	90,5	90,6	-	-
	Total input	kW	7,86	8,10	8,46	9,00	9,60	10,26	10,92	11,58	12,12	12,72	13,32	13,92	14,52	15,18	16,50	-	-
110.4	Airflow	m ³ /h	60000	60000	60000	60000	60000	60000	60000	60000	60000	60000	60000	60000	60000	-	-	-	-
	Airflow	l/s	16667	16667	16667	16667	16667	16667	16667	16667	16667	16667	16667	16667	16667	-	-	-	-
	Fan RPM	rpm	1379	1386	1401	1423	1445	1467	1488	1510	1532	1554	1577	1599	1621	-	-	-	-
	Sound pressure	dB(A)	90,7	90,6	90,6	90,8	91,0	91,2	91,4	91,6	91,9	91,9	91,9	91,9	91,9	-	-	-	-
	Total input	kW	9,18	9,42	9,78	10,38	11,04	11,64	12,36	13,02	13,80	14,40	15,00	15,66	16,32	-	-	-	-

The performance takes into account the pressure drops in the unit (pressure drops in handling coil, standard filters, etc.).
To determine the performance required of the fans, you must add to the usable static pressure desired the pressure drops of any accessories.

Handling electric fan performance - Minimum airflow

Available static pressure (Pa) (supply+return)			90	100	120	150	180	210	240	270	300	330	360	390	420	450	510
49.4	Airflow	m³/h	22000	22000	22000	22000	22000	22000	22000	22000	22000	22000	22000	22000	22000	22000	22000
	Airflow	l/s	6111	6111	6111	6111	6111	6111	6111	6111	6111	6111	6111	6111	6111	6111	6111
	Fan RPM	rpm	1032	1043	1060	1091	1120	1152	1180	1212	1239	1270	1297	1327	1354	1384	1439
	Sound pressure	dB(A)	79,6	79,7	80,0	80,4	80,9	81,0	81,0	81,0	81,1	81,1	81,3	81,8	82,3	82,7	83,6
	Total input	kW	2,09	2,17	2,31	2,56	2,81	3,06	3,27	3,51	3,72	3,99	4,25	4,53	4,80	5,10	5,73
54.4	Airflow	m³/h	22000	22000	22000	22000	22000	22000	22000	22000	22000	22000	22000	22000	22000	22000	22000
	Airflow	l/s	6111	6111	6111	6111	6111	6111	6111	6111	6111	6111	6111	6111	6111	6111	6111
	Fan RPM	rpm	1032	1043	1060	1091	1120	1152	1180	1212	1239	1270	1297	1327	1354	1384	1439
	Sound pressure	dB(A)	79,6	79,7	80,0	80,4	80,9	81,0	81,0	81,0	81,1	81,1	81,3	81,8	82,3	82,7	83,6
	Total input	kW	2,09	2,17	2,31	2,56	2,81	3,06	3,27	3,51	3,72	3,99	4,25	4,53	4,80	5,10	5,73
60.4	Airflow	m³/h	29000	29000	29000	29000	29000	29000	29000	29000	29000	29000	29000	29000	29000	29000	29000
	Airflow	l/s	8056	8056	8056	8056	8056	8056	8056	8056	8056	8056	8056	8056	8056	8056	8056
	Fan RPM	rpm	1029	1040	1057	1086	1118	1150	1178	1210	1238	1266	1296	1327	1353	1380	1439
	Sound pressure	dB(A)	80,6	80,7	81,0	81,5	82,0	82,0	82,0	82,0	82,1	82,1	82,5	82,9	83,4	83,9	84,8
	Total input	kW	2,79	2,89	3,07	3,38	3,75	4,04	4,32	4,68	4,96	5,28	5,64	6,04	6,40	6,76	7,60
70.4	Airflow	m³/h	29000	29000	29000	29000	29000	29000	29000	29000	29000	29000	29000	29000	29000	29000	29000
	Airflow	l/s	8056	8056	8056	8056	8056	8056	8056	8056	8056	8056	8056	8056	8056	8056	8056
	Fan RPM	rpm	1035	1045	1065	1095	1125	1156	1186	1216	1246	1275	1304	1332	1361	1389	1444
	Sound pressure	dB(A)	82,0	82,1	82,4	82,8	83,1	83,1	83,1	83,2	83,2	83,3	83,8	84,3	84,7	85,2	86,1
	Total input	kW	2,84	2,96	3,16	3,48	3,80	4,12	4,40	4,72	5,04	5,40	5,72	6,12	6,48	6,88	7,68
80.4	Airflow	m³/h	29000	29000	29000	29000	29000	29000	29000	29000	29000	29000	29000	29000	29000	29000	29000
	Airflow	l/s	8056	8056	8056	8056	8056	8056	8056	8056	8056	8056	8056	8056	8056	8056	8056
	Fan RPM	rpm	1035	1045	1065	1095	1125	1156	1186	1216	1246	1275	1304	1332	1361	1389	1444
	Sound pressure	dB(A)	82,0	82,1	82,4	82,8	83,1	83,1	83,1	83,2	83,2	83,3	83,8	84,3	84,7	85,2	86,1
	Total input	kW	2,84	2,96	3,16	3,48	3,80	4,12	4,40	4,72	5,04	5,40	5,72	6,12	6,48	6,88	7,68
90.4	Airflow	m³/h	38000	38000	38000	38000	38000	38000	38000	38000	38000	38000	38000	38000	38000	38000	38000
	Airflow	l/s	10556	10556	10556	10556	10556	10556	10556	10556	10556	10556	10556	10556	10556	10556	10556
	Fan RPM	rpm	956	967	990	1025	1060	1093	1127	1159	1192	1224	1256	1287	1317	1347	1405
	Sound pressure	dB(A)	81,7	81,9	82,0	82,0	82,0	82,1	82,4	83,1	83,7	84,3	84,9	85,6	86,4	87,1	88,5
	Total input	kW	3,60	3,78	4,02	4,44	4,86	5,28	5,70	6,18	6,66	7,20	7,74	8,28	8,82	9,36	10,50
100.4	Airflow	m³/h	38000	38000	38000	38000	38000	38000	38000	38000	38000	38000	38000	38000	38000	38000	38000
	Airflow	l/s	10556	10556	10556	10556	10556	10556	10556	10556	10556	10556	10556	10556	10556	10556	10556
	Fan RPM	rpm	956	967	990	1025	1060	1093	1127	1159	1192	1224	1256	1287	1317	1347	1405
	Sound pressure	dB(A)	81,7	81,9	82,0	82,0	82,0	82,1	82,4	83,1	83,7	84,3	84,9	85,6	86,4	87,1	88,5
	Total input	kW	3,60	3,78	4,02	4,44	4,86	5,28	5,70	6,18	6,66	7,20	7,74	8,28	8,82	9,36	10,50
110.4	Airflow	m³/h	38000	38000	38000	38000	38000	38000	38000	38000	38000	38000	38000	38000	38000	38000	38000
	Airflow	l/s	10556	10556	10556	10556	10556	10556	10556	10556	10556	10556	10556	10556	10556	10556	10556
	Fan RPM	rpm	956	967	990	1025	1060	1093	1127	1159	1192	1224	1256	1287	1317	1347	1405
	Sound pressure	dB(A)	81,7	81,9	82,0	82,0	82,0	82,1	82,4	83,1	83,7	84,3	84,9	85,6	86,4	87,1	88,5
	Total input	kW	3,60	3,78	4,02	4,44	4,86	5,28	5,70	6,18	6,66	7,20	7,74	8,28	8,82	9,36	10,50

The performance takes into account the pressure drops in the unit (pressure drops in handling coil, standard filters, etc.).
 To determine the performance required of the fans, you must add to the usable static pressure desired the pressure drops of any accessories.

Handling electric fan performance - High airflow

Available static pressure (Pa) (supply+return)			90	100	120	150	180	210	240	270	300	330	360	390	420
49.4	Airflow	m ³ /h	34000	34000	34000	34000	34000	34000	34000	34000	34000	-	-	-	-
	Airflow	l/s	9444	9444	9444	9444	9444	9444	9444	9444	9444	-	-	-	-
	Fan RPM	rpm	1484	1493	1505	1527	1546	1567	1585	1603	1624	-	-	-	-
	Sound pressure	dB(A)	89,3	89,2	89,2	89,1	89,0	89,0	89,0	89,1	89,3	-	-	-	-
	Total input	kW	5,37	5,52	5,70	6,06	6,36	6,72	7,05	7,38	7,77	-	-	-	-
54.4	Airflow	m ³ /h	34000	34000	34000	34000	34000	34000	34000	34000	34000	-	-	-	-
	Airflow	l/s	9444	9444	9444	9444	9444	9444	9444	9444	9444	-	-	-	-
	Fan RPM	rpm	1484	1493	1505	1527	1546	1567	1585	1603	1624	-	-	-	-
	Sound pressure	dB(A)	89,3	89,2	89,2	89,1	89,0	89,0	89,0	89,1	89,3	-	-	-	-
	Total input	kW	5,37	5,52	5,70	6,06	6,36	6,72	7,05	7,38	7,77	-	-	-	-
60.4	Airflow	m ³ /h	47000	47000	47000	47000	47000	47000	47000	-	-	-	-	-	-
	Airflow	l/s	13056	13056	13056	13056	13056	13056	13056	-	-	-	-	-	-
	Fan RPM	rpm	1545	1552	1566	1586	1605	1625	1641	-	-	-	-	-	-
	Sound pressure	dB(A)	91,3	91,3	91,2	91,1	91,1	91,0	91,0	-	-	-	-	-	-
	Total input	kW	8,04	8,20	8,52	9,00	9,44	9,92	10,36	-	-	-	-	-	-
70.4	Airflow	m ³ /h	47000	47000	47000	47000	47000	47000	-	-	-	-	-	-	-
	Airflow	l/s	13056	13056	13056	13056	13056	13056	-	-	-	-	-	-	-
	Fan RPM	rpm	1156	1562	1575	1595	1614	1633	-	-	-	-	-	-	-
	Sound pressure	dB(A)	92,7	92,6	92,6	92,5	92,4	92,3	0,0	-	-	-	-	-	-
	Total input	kW	8,28	8,44	8,76	9,20	9,68	10,16	-	-	-	-	-	-	-
80.4	Airflow	m ³ /h	47000	47000	47000	47000	47000	47000	-	-	-	-	-	-	-
	Airflow	l/s	13056	13056	13056	13056	13056	13056	-	-	-	-	-	-	-
	Fan RPM	rpm	1156	1562	1575	1595	1614	1633	-	-	-	-	-	-	-
	Sound pressure	dB(A)	92,7	92,6	92,6	92,5	92,4	92,3	0,0	-	-	-	-	-	-
	Total input	kW	8,28	8,44	8,76	9,20	9,68	10,16	-	-	-	-	-	-	-
90.4	Airflow	m ³ /h	60000	60000	60000	60000	60000	60000	60000	60000	60000	60000	60000	60000	60000
	Airflow	l/s	16667	16667	16667	16667	16667	16667	16667	16667	16667	16667	16667	16667	16667
	Fan RPM	rpm	1379,0	1386,0	1401,0	1423,0	1445,0	1467,0	1488,0	1510,0	1532,0	1554,0	1577,0	1599,0	1621,0
	Sound pressure	dB(A)	90,7	90,6	90,6	90,8	91,0	91,2	91,4	91,6	91,9	91,9	91,9	91,9	91,9
	Total input	kW	9,18	9,42	9,78	10,38	11,04	11,64	12,36	13,02	13,80	14,40	15,00	15,66	16,32
100.4	Airflow	m ³ /h	60000	60000	60000	60000	60000	60000	60000	60000	60000	60000	60000	60000	60000
	Airflow	l/s	16667	16667	16667	16667	16667	16667	16667	16667	16667	16667	16667	16667	16667
	Fan RPM	rpm	1379,0	1386,0	1401,0	1423,0	1445,0	1467,0	1488,0	1510,0	1532,0	1554,0	1577,0	1599,0	1621,0
	Sound pressure	dB(A)	90,7	90,6	90,6	90,8	91,0	91,2	91,4	91,6	91,9	91,9	91,9	91,9	91,9
	Total input	kW	9,18	9,42	9,78	10,38	11,04	11,64	12,36	13,02	13,80	14,40	15,00	15,66	16,32
110.4	Airflow	m ³ /h	60000	60000	60000	60000	60000	60000	60000	60000	60000	60000	60000	60000	60000
	Airflow	l/s	16667	16667	16667	16667	16667	16667	16667	16667	16667	16667	16667	16667	16667
	Fan RPM	rpm	1379,0	1386,0	1401,0	1423,0	1445,0	1467,0	1488,0	1510,0	1532,0	1554,0	1577,0	1599,0	1621,0
	Sound pressure	dB(A)	90,7	90,6	90,6	90,8	91,0	91,2	91,4	91,6	91,9	91,9	91,9	91,9	91,9
	Total input	kW	9,18	9,42	9,78	10,38	11,04	11,64	12,36	13,02	13,80	14,40	15,00	15,66	16,32

The performance takes into account the pressure drops in the unit (pressure drops in handling coil, standard filters, etc.).
To determine the performance required of the fans, you must add to the usable static pressure desired the pressure drops of any accessories.

High static pressure electric fan performance - Standard airflow

Available static pressure (Pa) (supply+return)			300	360	420	480	540	600	660	720	780	840	900	960	1020	1080	1140	
49.4	Airflow	m ³ /h	26000	26000	26000	26000	26000	26000	26000	26000	26000	26000	26000	26000	26000	26000	26000	26000
	Airflow	l/s	7222	7222	7222	7222	7222	7222	7222	7222	7222	7222	7222	7222	7222	7222	7222	7222
	Fan RPM	rpm	1550	1593	1638	1682	1727	1775	1817	1854	1900	1940	1981	2020	2055	2098	2136	
	Sound power	dB(A)	94,4	94,2	94,2	94,4	94,8	95,1	95,4	95,7	96,1	96,4	96,8	97,2	97,5	97,9	98,3	
	Total input	kW	5,37	5,91	6,51	7,08	7,68	8,37	9,00	9,60	10,38	11,07	11,73	12,42	13,05	13,99	14,61	
54.4	Airflow	m ³ /h	29000	29000	29000	29000	29000	29000	29000	29000	29000	29000	29000	29000	29000	29000	29000	-
	Airflow	l/s	8056	8056	8056	8056	8056	8056	8056	8056	8056	8056	8056	8056	8056	8056	8056	-
	Fan RPM	rpm	1673	1713	1753	1798	1833	1877	1917	1956	1995	2032	2070	2111	2147	2181	-	
	Sound power	dB(A)	97,0	96,8	96,7	96,6	96,6	96,8	97,1	97,3	97,6	97,8	98,1	98,4	98,7	98,9	-	
	Total input	kW	6,48	7,08	7,68	8,37	8,97	9,69	10,35	11,04	11,76	12,48	13,23	14,10	14,91	15,60	-	
60.4	Airflow	m ³ /h	33000	33000	33000	33000	33000	33000	33000	33000	33000	33000	33000	33000	33000	33000	33000	33000
	Airflow	l/s	9167	9167	9167	9167	9167	9167	9167	9167	9167	9167	9167	9167	9167	9167	9167	9167
	Fan RPM	rpm	1500	1548	1596	1643	1690	1732	1777	1821	1867	1907	1946	1991	2031	2069	2109	
	Sound power	dB(A)	94,4	94,3	94,5	94,9	95,2	95,6	96,0	96,3	96,7	97,1	97,6	98,0	98,4	98,8	99,2	
	Total input	kW	6,64	7,40	8,12	8,92	9,72	10,48	11,36	12,24	13,20	14,00	14,84	15,84	16,80	17,72	18,72	
70.4	Airflow	m ³ /h	37000	37000	37000	37000	37000	37000	37000	37000	37000	37000	37000	37000	37000	37000	37000	37000
	Airflow	l/s	10278	10278	10278	10278	10278	10278	10278	10278	10278	10278	10278	10278	10278	10278	10278	10278
	Fan RPM	rpm	1631	1673	1715	1757	1799	1841	1882	1922	1962	2001	2039	2078	2115	2153	2190	
	Sound power	dB(A)	98,4	98,2	98,2	98,1	98,3	98,5	98,8	99,0	99,3	99,6	99,8	100,1	100,4	100,7	101,0	
	Total input	kW	8,16	8,96	9,76	10,60	11,44	12,28	13,20	14,12	15,04	16,04	17,04	18,04	19,00	20,00	21,04	
80.4	Airflow	m ³ /h	44000	44000	44000	44000	44000	44000	44000	44000	44000	44000	44000	-	-	-	-	
	Airflow	l/s	12222	12222	12222	12222	12222	12222	12222	12222	12222	12222	12222	-	-	-	-	
	Fan RPM	rpm	1857	1873	1909	1945	1980	2016	2051	2086	2122	2157	2192	-	-	-	-	
	Sound power	dB(A)	102,5	102,4	102,2	102,1	102,0	102,0	101,9	101,9	102,0	102,2	102,3	-	-	-	-	
	Total input	kW	11,44	11,80	12,64	13,56	14,48	15,44	16,44	17,48	18,48	19,48	20,52	-	-	-	-	
90.4	Airflow	m ³ /h	51000	51000	51000	51000	51000	51000	51000	51000	51000	51000	51000	51000	51000	51000	51000	51000
	Airflow	l/s	14167	14167	14167	14167	14167	14167	14167	14167	14167	14167	14167	14167	14167	14167	14167	14167
	Fan RPM	rpm	1561	1606	1652	1697	1742	1786	1828	1870	1912	1953	1993	2033	2073	2111	2150	
	Sound power	dB(A)	98,2	98,1	98,3	98,5	98,8	99,1	99,4	99,8	100,1	100,4	100,8	101,1	101,5	101,9	102,3	
	Total input	kW	11,16	12,36	13,50	14,64	15,90	17,16	18,48	19,80	21,18	22,50	23,88	25,32	26,76	28,26	29,76	
100.4	Airflow	m ³ /h	56000	56000	56000	56000	56000	56000	56000	56000	56000	56000	56000	56000	56000	56000	56000	56000
	Airflow	l/s	15556	15556	15556	15556	15556	15556	15556	15556	15556	15556	15556	15556	15556	15556	15556	15556
	Fan RPM	rpm	1667	1709	1750	1792	1833	1874	1915	1955	1994	2032	2070	2108	2145	2182	2219	
	Sound power	dB(A)	100,3	100,2	100,1	100,2	100,4	100,6	100,9	101,1	101,4	101,6	101,9	102,2	102,5	102,7	103,0	
	Total input	kW	13,14	14,34	15,60	16,92	18,18	19,50	20,82	22,26	23,70	25,20	26,76	28,20	29,70	31,26	32,82	
110.4	Airflow	m ³ /h	60000	60000	60000	60000	60000	60000	60000	60000	60000	60000	60000	60000	60000	-	-	
	Airflow	l/s	16667	16667	16667	16667	16667	16667	16667	16667	16667	16667	16667	16667	16667	-	-	
	Fan RPM	rpm	1752	1792	1830	1869	1908	1947	1985	2023	2061	2098	2134	2170	2206	-	-	
	Sound power	dB(A)	101,9	101,8	101,7	101,6	101,7	101,8	102,0	102,2	102,4	102,6	102,9	103,1	103,3	-	-	
	Total input	kW	14,94	16,20	17,46	18,84	20,22	21,54	22,98	24,42	25,92	27,42	28,98	30,60	32,28	-	-	

The performance takes into account the pressure drops in the unit (pressure drops in handling coil, standard filters, etc.).
 To determine the performance required of the fans, you must add to the usable static pressure desired the pressure drops of any accessories.
 Performances with "VENH - High static pressure fans" option

High static pressure electric fan performance - Minimum airflow

Available static pressure (Pa) (supply+return)			420	480	540	600	660	720	780	840	900	960	1020	1080	1140	1200	1260	1320	
49.4	Airflow	m ³ /h	22000	22000	22000	22000	22000	22000	22000	22000	22000	22000	22000	22000	22000	22000	22000	22000	22000
	Airflow	l/s	6111	6111	6111	6111	6111	6111	6111	6111	6111	6111	6111	6111	6111	6111	6111	6111	6111
	Fan RPM	rpm	1496	1545	1596	1642	1692	1737	1785	1828	1874	1919	1957	2000	2044	2081	2126	2161	2161
	Sound power	dB(A)	91,3	91,9	92,3	92,8	93,3	93,9	94,4	94,9	95,4	96,0	96,5	97,0	97,6	98,2	98,7	99,2	99,2
	Total input	kW	5,19	5,70	6,30	6,87	7,47	8,01	8,64	9,27	9,93	10,65	11,25	11,94	12,63	13,26	14,07	14,70	14,70
54.4	Airflow	m ³ /h	22000	22000	22000	22000	22000	22000	22000	22000	22000	22000	22000	22000	22000	22000	22000	22000	22000
	Airflow	l/s	6111	6111	6111	6111	6111	6111	6111	6111	6111	6111	6111	6111	6111	6111	6111	6111	6111
	Fan RPM	rpm	1496	1545	1596	1642	1692	1737	1785	1828	1874	1919	1957	2000	2044	2081	2126	2161	2161
	Sound power	dB(A)	91,3	91,9	92,3	92,8	93,3	93,9	94,4	94,9	95,4	96,0	96,5	97,0	97,6	98,2	98,7	99,2	99,2
	Total input	kW	5,19	5,70	6,30	6,87	7,47	8,01	8,64	9,27	9,93	10,65	11,25	11,94	12,63	13,26	14,07	14,70	14,70
60.4	Airflow	m ³ /h	29000	29000	29000	29000	29000	29000	29000	29000	29000	29000	29000	29000	29000	29000	29000	29000	29000
	Airflow	l/s	8056	8056	8056	8056	8056	8056	8056	8056	8056	8056	8056	8056	8056	8056	8056	8056	8056
	Fan RPM	rpm	1489	1542	1590	1644	1686	1732	1783	1826	1869	1914	1953	1994	2040	2080	2122	2164	2164
	Sound power	dB(A)	92,5	92,9	93,4	93,9	94,4	95,0	95,5	96,1	96,6	97,1	97,7	98,3	98,9	99,4	100,0	100,5	100,5
	Total input	kW	6,84	7,60	8,32	9,16	9,84	10,60	11,52	12,32	13,16	14,08	14,88	15,72	16,72	17,64	18,60	19,64	19,64
70.4	Airflow	m ³ /h	29000	29000	29000	29000	29000	29000	29000	29000	29000	29000	29000	29000	29000	29000	29000	29000	29000
	Airflow	l/s	8056	8056	8056	8056	8056	8056	8056	8056	8056	8056	8056	8056	8056	8056	8056	8056	8056
	Fan RPM	rpm	1496	1546	1596	1644	1692	1739	1785	1830	1874	1918	1961	2003	2045	2086	2126	2166	2166
	Sound power	dB(A)	93,7	94,1	94,5	95,0	95,4	95,9	96,4	97,0	97,5	98,0	98,6	99,2	99,8	100,3	100,9	101,5	101,5
	Total input	kW	6,92	7,64	8,44	9,20	9,92	10,72	11,56	12,40	13,24	14,16	15,04	15,92	16,84	17,76	18,72	19,68	19,68
80.4	Airflow	m ³ /h	29000	29000	29000	29000	29000	29000	29000	29000	29000	29000	29000	29000	29000	29000	29000	29000	29000
	Airflow	l/s	8056	8056	8056	8056	8056	8056	8056	8056	8056	8056	8056	8056	8056	8056	8056	8056	8056
	Fan RPM	rpm	1496	1546	1596	1644	1692	1739	1785	1830	1874	1918	1961	2003	2045	2086	2126	2166	2166
	Sound power	dB(A)	93,7	94,1	94,5	95,0	95,4	95,9	96,4	97,0	97,5	98,0	98,6	99,2	99,8	100,3	100,9	101,5	101,5
	Total input	kW	6,92	7,64	8,44	9,20	9,92	10,72	11,56	12,40	13,24	14,16	15,04	15,92	16,84	17,76	18,72	19,68	19,68
90.4	Airflow	m ³ /h	38000	38000	38000	38000	38000	38000	38000	38000	38000	38000	38000	38000	38000	38000	38000	38000	38000
	Airflow	l/s	10556	10556	10556	10556	10556	10556	10556	10556	10556	10556	10556	10556	10556	10556	10556	10556	10556
	Fan RPM	rpm	1423	1478	1532	1584	1635	1684	1733	1781	1828	1874	1920	1965	2009	2052	2095	2136	2136
	Sound power	dB(A)	92,7	94,3	95,0	95,6	96,3	97,0	97,8	98,5	99,3	100,1	100,8	101,5	102,2	102,9	103,6	104,2	104,2
	Total input	kW	9,24	10,26	11,28	12,36	13,44	14,64	15,78	16,92	18,12	19,32	20,64	21,90	23,28	24,66	26,10	27,42	27,42
100.4	Airflow	m ³ /h	38000	38000	38000	38000	38000	38000	38000	38000	38000	38000	38000	38000	38000	38000	38000	38000	38000
	Airflow	l/s	10556	10556	10556	10556	10556	10556	10556	10556	10556	10556	10556	10556	10556	10556	10556	10556	10556
	Fan RPM	rpm	1423	1478	1532	1584	1635	1684	1733	1781	1828	1874	1920	1965	2009	2052	2095	2136	2136
	Sound power	dB(A)	92,7	94,3	95,0	95,6	96,3	97,0	97,8	98,5	99,3	100,1	100,8	101,5	102,2	102,9	103,6	104,2	104,2
	Total input	kW	9,24	10,26	11,28	12,36	13,44	14,64	15,78	16,92	18,12	19,32	20,64	21,90	23,28	24,66	26,10	27,42	27,42
110.4	Airflow	m ³ /h	38000	38000	38000	38000	38000	38000	38000	38000	38000	38000	38000	38000	38000	38000	38000	38000	38000
	Airflow	l/s	10556	10556	10556	10556	10556	10556	10556	10556	10556	10556	10556	10556	10556	10556	10556	10556	10556
	Fan RPM	rpm	1423	1478	1532	1584	1635	1684	1733	1781	1828	1874	1920	1965	2009	2052	2095	2136	2136
	Sound power	dB(A)	92,7	94,3	95,0	95,6	96,3	97,0	97,8	98,5	99,3	100,1	100,8	101,5	102,2	102,9	103,6	104,2	104,2
	Total input	kW	9,24	10,26	11,28	12,36	13,44	14,64	15,78	16,92	18,12	19,32	20,64	21,90	23,28	24,66	26,10	27,42	27,42

The performance takes into account the pressure drops in the unit (pressure drops in handling coil, standard filters, etc.).
 To determine the performance required of the fans, you must add to the usable static pressure desired the pressure drops of any accessories.
 Performances with "VENH - High static pressure fans" option

High static pressure electric fan performance - High airflow

Available static pressure (Pa) (supply+return)			240	300	360	420	480	540	600	660	720	780	840	900	960	1020
49.4	Airflow	m ³ /h	34000	34000	34000	34000	34000	34000	34000	34000	34000	34000	34000	-	-	-
	Airflow	l/s	9444	9444	9444	9444	9444	9444	9444	9444	9444	9444	9444	-	-	-
	Fan RPM	rpm	1901	1884	1919	1956	1990	2026	2059	2095	2128	2164	2197	-	-	-
	Sound power	dB(A)	101,2	100,9	100,7	100,5	100,3	100,2	100,1	100,1	100,0	100,1	100,3	-	-	-
	Total input	kW	8,88	8,85	9,48	10,17	10,83	11,55	12,27	13,05	13,83	14,64	15,39	-	-	-
54.4	Airflow	m ³ /h	34000	34000	34000	34000	34000	34000	34000	34000	34000	34000	34000	-	-	-
	Airflow	l/s	9444	9444	9444	9444	9444	9444	9444	9444	9444	9444	9444	-	-	-
	Fan RPM	rpm	1901	1884	1919	1956	1990	2026	2059	2095	2128	2164	2197	-	-	-
	Sound power	dB(A)	101,2	100,9	100,7	100,5	100,3	100,2	100,1	100,1	100,0	100,1	100,3	-	-	-
	Total input	kW	8,88	8,85	9,48	10,17	10,83	11,55	12,27	13,05	13,83	14,64	15,39	-	-	-
60.4	Airflow	m ³ /h	47000	47000	47000	47000	47000	47000	47000	47000	47000	-	-	-	-	-
	Airflow	l/s	13056	13056	13056	13056	13056	13056	13056	13056	13056	-	-	-	-	-
	Fan RPM	rpm	1916	1949	1983	2019	2052	2086	2118	2153	2184	-	-	-	-	-
	Sound power	dB(A)	103,3	103,0	102,7	102,5	102,4	102,3	102,2	102,1	102,0	-	-	-	-	-
	Total input	kW	12,16	12,96	13,80	14,76	15,68	16,68	17,64	18,72	19,76	-	-	-	-	-
70.4	Airflow	m ³ /h	47000	47000	47000	47000	47000	47000	47000	47000	47000	-	-	-	-	-
	Airflow	l/s	13056	13056	13056	13056	13056	13056	13056	13056	13056	-	-	-	-	-
	Fan RPM	rpm	1921	1956	1991	2025	2059	2092	2125	2158	2191	-	-	-	-	-
	Sound power	dB(A)	104,3	104,0	103,9	103,7	103,6	103,5	103,4	103,4	103,3	-	-	-	-	-
	Total input	kW	12,32	13,16	14,04	14,96	15,92	16,88	17,88	18,92	20,00	-	-	-	-	-
80.4	Airflow	m ³ /h	47000	47000	47000	47000	47000	47000	47000	47000	47000	-	-	-	-	-
	Airflow	l/s	13056	13056	13056	13056	13056	13056	13056	13056	13056	-	-	-	-	-
	Fan RPM	rpm	1921	1956	1991	2025	2059	2092	2125	2158	2191	-	-	-	-	-
	Sound power	dB(A)	104,3	104,0	103,9	103,7	103,6	103,5	103,4	103,4	103,3	-	-	-	-	-
	Total input	kW	12,32	13,16	14,04	14,96	15,92	16,88	17,88	18,92	20,00	-	-	-	-	-
90.4	Airflow	m ³ /h	60000	60000	60000	60000	60000	60000	60000	60000	60000	60000	60000	60000	60000	60000
	Airflow	l/s	16667	16667	16667	16667	16667	16667	16667	16667	16667	16667	16667	16667	16667	16667
	Fan RPM	rpm	1713	1752	1792	1830	1869	1908	1947	1985	2023	2061	2098	2134	2170	2206
	Sound power	dB(A)	102,1	101,9	101,8	101,7	101,6	101,7	101,8	102,0	102,2	102,4	102,6	102,9	103,1	103,3
	Total input	kW	13,74	14,94	16,20	17,46	18,84	20,22	21,54	22,98	24,42	25,92	27,42	28,98	30,60	32,28
100.4	Airflow	m ³ /h	60000	60000	60000	60000	60000	60000	60000	60000	60000	60000	60000	60000	60000	60000
	Airflow	l/s	16667	16667	16667	16667	16667	16667	16667	16667	16667	16667	16667	16667	16667	16667
	Fan RPM	rpm	1713	1752	1792	1830	1869	1908	1947	1985	2023	2061	2098	2134	2170	2206
	Sound power	dB(A)	102,1	101,9	101,8	101,7	101,6	101,7	101,8	102,0	102,2	102,4	102,6	102,9	103,1	103,3
	Total input	kW	13,74	14,94	16,20	17,46	18,84	20,22	21,54	22,98	24,42	25,92	27,42	28,98	30,60	32,28
110.4	Airflow	m ³ /h	60000	60000	60000	60000	60000	60000	60000	60000	60000	60000	60000	60000	60000	60000
	Airflow	l/s	16667	16667	16667	16667	16667	16667	16667	16667	16667	16667	16667	16667	16667	16667
	Fan RPM	rpm	1713	1752	1792	1830	1869	1908	1947	1985	2023	2061	2098	2134	2170	2206
	Sound power	dB(A)	102,1	101,9	101,8	101,7	101,6	101,7	101,8	102,0	102,2	102,4	102,6	102,9	103,1	103,3
	Total input	kW	13,74	14,94	16,20	17,46	18,84	20,22	21,54	22,98	24,42	25,92	27,42	28,98	30,60	32,28

The performance takes into account the pressure drops in the unit (pressure drops in handling coil, standard filters, etc.).
 To determine the performance required of the fans, you must add to the usable static pressure desired the pressure drops of any accessories.
 Performances with "VENH - High static pressure fans" option

Exhaust electric fan performance

AVAILABLE STATIC PRESSURE (EXHAUST) (Pa)			150				
% OF EXHAUST AIR			10%	20%	30%	40%	50%
49.4	Airflow	m ³ /h	2600	5200	7800	10400	13000
	Airflow	l/s	722	1444	2167	2889	3611
	Fan RPM	rpm	663	707	811	955	1115
	Total input	kW	0,16	0,47	0,67	0,96	1,37
54.4	Airflow	m ³ /h	2900	5800	8700	11600	14500
	Airflow	l/s	806	1611	2417	3222	4028
	Fan RPM	rpm	665	726	858	1029	1212
	Total input	kW	0,33	0,51	0,75	1,13	1,66
60.4	Airflow	m ³ /h	3300	6600	9900	13200	16500
	Airflow	l/s	917	1833	2750	3667	4583
	Fan RPM	rpm	600	603	649	719	811
	Total input	kW	0,47	0,61	0,79	1,01	1,33
70.4	Airflow	m ³ /h	3700	7400	11100	14800	18500
	Airflow	l/s	1028	2056	3083	4111	5139
	Fan RPM	rpm	600	611	672	761	871
	Total input	kW	0,49	0,65	0,86	1,16	1,57
80.4	Airflow	m ³ /h	4400	8800	13200	17600	22000
	Airflow	l/s	1222	2444	3667	4889	6111
	Fan RPM	rpm	600	630	719	843	987
	Total input	kW	0,52	0,72	1,01	1,45	2,10
90.4	Airflow	m ³ /h	5200	10400	15600	20800	26000
	Airflow	l/s	1444	2889	4333	5778	7222
	Fan RPM	rpm	590	652	780	943	1123
	Total input	kW	0.54	0.80	1.21	1.88	2.88
100.4	Airflow	m ³ /h	5600	11200	16800	22400	28000
	Airflow	l/s	1556	3111	4667	6222	7778
	Fan RPM	rpm	591	669	815	998	1193
	Total input	kW	0.56	0.85	1.34	2.15	3.38
110.4	Airflow	m ³ /h	6000	12000	18000	24000	30000
	Airflow	l/s	1667	3333	5000	6667	8333
	Fan RPM	rpm	593	686	853	1052	1265
	Total input	kW	0.57	0.91	1.48	2.44	3.96

The percentage of exhaust air refers to the unit rated flow.

In the return section, the exhaust fans collect the quantity of air that will be exhausted.

The data refer to an available static pressure of 150 Pa which usually occurs in the systems to exhaust the air.

Option compatibility

REF.	DESCRIPTION	CAK	CBK	CCK	CCKP
Versions					
THR	THOR thermodynamic energy recovery of the exhaust air (CCKP version)	-	-	-	√
FC	Thermal FREE-COOLING	-	-	√	√
FCE	Enthalpy FREE-COOLING	-	-	0	0
Configurations					
CHWER	Energy recovery from the food refrigeration	0	0	0	0
CHW2	two-rows hot water coil	0	0	0	0
3WVM	Modulating 3-way valve	0	0	0	0
2WVM	Modulating 2-way valve	0	0	0	0
EH	Electric heaters.	0	0	0	0
AMRX	Rubber antivibration mounts	◇	◇	◇	◇
RCX	Roof curb	◇	◇	◇	◇
PCM0	Sandwich panels of the handling zone in M0 fire reaction class	0	0	0	0
Refrigeration circuit					
EVE	Electronic expansion valve	√	√	√	√
MHP	High and low pressure gauges	0	0	0	0
CPHG	hot gas re-heating coil	0	0	0	0
ACL	Internal water connections provided by the Customer	√	√	√	√
ACPC	Hydraulic pipework arrangement for loop with constant flow-rate	0	0	0	0
ACPV	Hydraulic pipework arrangement for loop with variable flow-rate	0	0	0	0
ACPM	Hydraulic pipework arrangement for system with disposable water	0	0	0	0
IFWX	Steel mesh strainer water side	0	0	0	0
Aeraulic circuit					
M0	Front air outlet	√	√	√	√
M3	Downflow supply	0	0	0	0
M5	Upflow supply	0	0	0	0
RO	Horizontal return	√	√	√	√
R3	Downflow return	0	0	0	0
PCOSM	Constant supply airflow	0	0	0	0
PVAR	Variable airflow	0	0	0	0
FPG4	Pleated air filter class G4 (EN779 norm)	√	√	√	√
F7	High efficiency F7 air filter	0	0	0	0
FES	Electronic filters	0	0	0	0
PSAF	Clogged filter differential pressure switch air side	0	0	0	0
HSE	Immersed electrodes steam humidifier	0	0	0	0
HWS	Steam humidifier with disposable water	0	0	0	0
LTEMP1	Application for low outdoor temperature	0	0	0	0
VENH	High static pressure fans	0	0	0	0
PAQC	Air quality probe for CO2 rate check	-	0	0	0
PAQCV	Air quality sensor for CO2 and VOC rate check	-	0	0	0
SER	Outdoor air damper manually set	-	√	-	-
SERM	Outdoor air motorized on/off damper	-	0	-	-
SFCM	Modulating motorized FREE-COOLING damper	-	0	-	-
SFCEM	Modulating motorized FREE-COOLING damper and min. outdoor air motorized ON/OFF damper	-	-	0	0

√ Standard component

0 Optional component

◇ Separately supplied accessory (optional)

- Not available

REF.	DESCRIPTION	CAK	CBK	CCK	CCKP
Electric circuit					
CRC	Remote control with user interface	√	√	√	√
NCRC	Remote control with user interface: not required	0	0	0	0
MOB	Serial communication module to Modbus supervisor	0	0	0	0
LON	Serial communication module to LonWorks supervisor	0	0	0	0
BACIP	Serial communication module for BACnet-IP supervisor	0	0	0	0
SIX	Service interface	◊	◊	◊	◊
CLMX	Clivet Master System	◊	◊	◊	◊
DESM	Smoke detector	0	0	0	0
PM	Phase monitor	0	0	0	0
MF2	Multi-function phase monitor	0	0	0	0
PFCC	Power factor correction capacitors (cosφ > 0.95)	0	0	0	0
SFSTC	Progressive compressor start-up device	0	0	0	0
Various					
PTCO	Set up for shipping via container	0	0	0	0

√ Standard component

0 Optional component

◊ Separately supplied accessory (optional)

- Not available

Dimensional drawings

Size 49.4 - 54.4 - CAK,CBK, CCK and CCKP configurations

DAA7W49.4_CAK-CBK-CCK-CCKP_1 REV01
DATA/DATE 30/11/2018

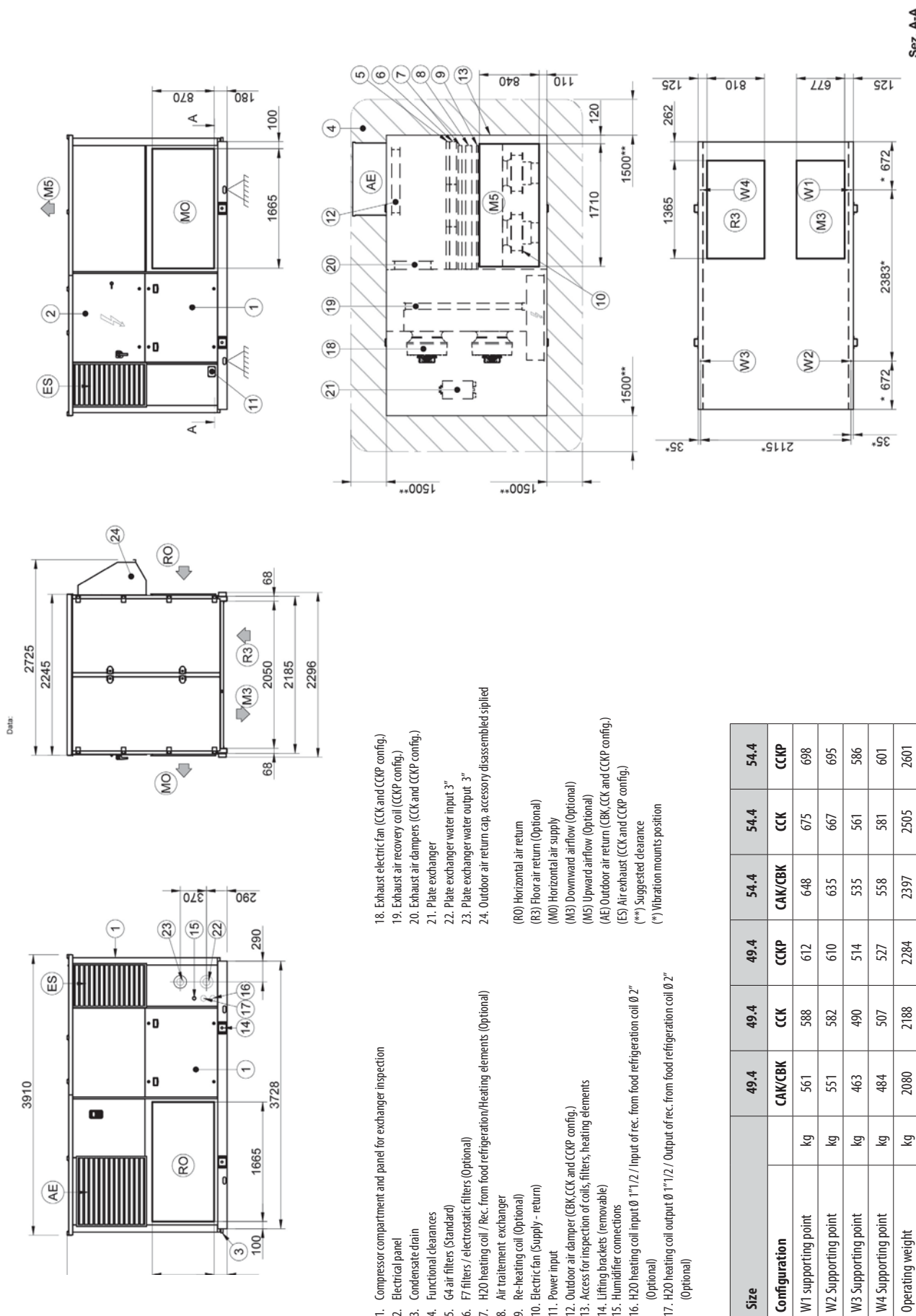

Sez. A-A

Size	49.4	49.4	49.4	54.4	54.4	54.4
Configuration	CAK/CBK	CCK	CCKP	CAK/CBK	CCK	CCKP
W1 supporting point	kg	561	588	612	648	698
W2 Supporting point	kg	551	582	610	635	695
W3 Supporting point	kg	463	490	514	535	586
W4 Supporting point	kg	484	507	527	558	601
Operating weight	kg	2080	2188	2284	2397	2601
Shipping weight	kg	2059	2167	2263	2376	2580

The presence of optional accessories may result in a substantial variation of the weights shown in the table.

Size 60.4 - 70.4 - 80.4 CAK,CBK, CCK and CCKP configurations

DAA7W60.4_CAK-CBK-CCK-CCKP_1 REV01
DATA/DATE 21/12/2018

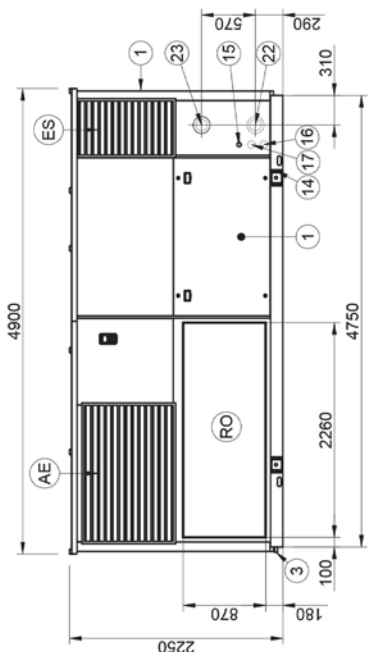
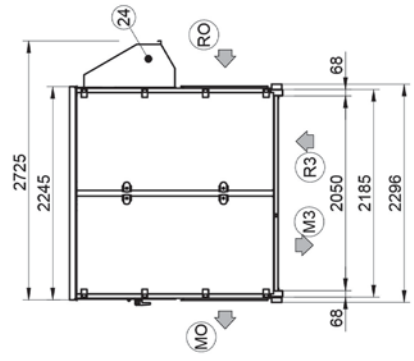
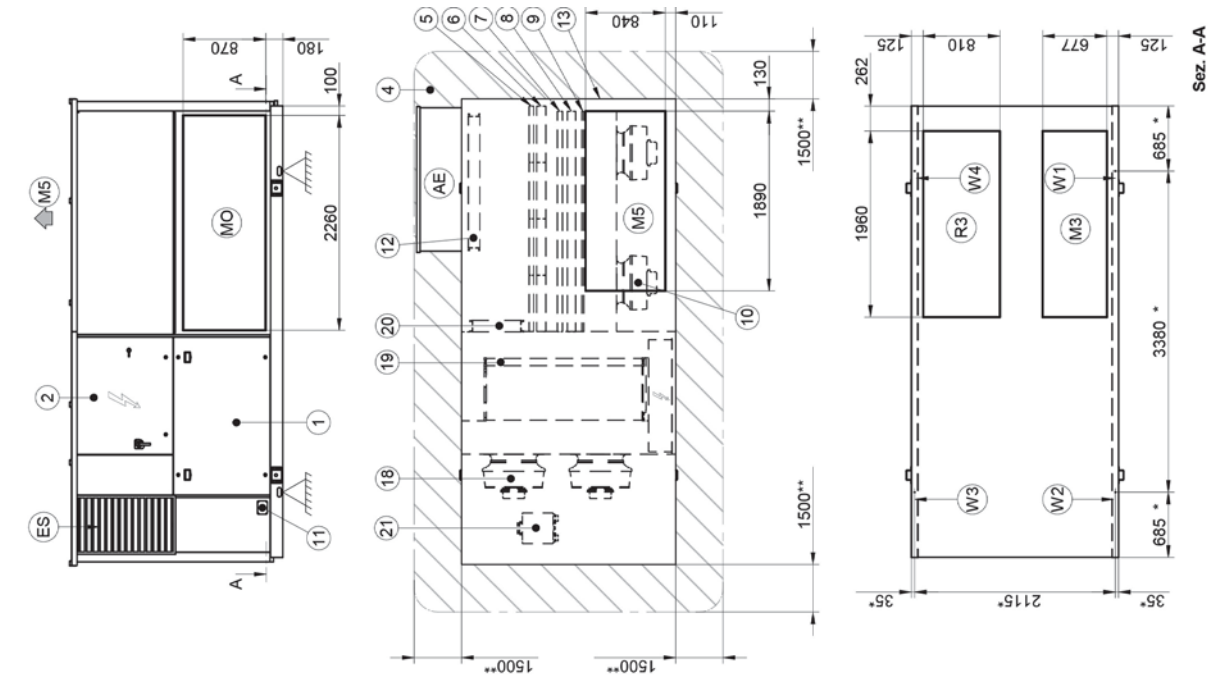

- 1. Compressor compartment and panel for exchanger inspection
- 2. Electrical panel
- 3. Condensate drain
- 4. Functional clearances
- 5. G4 air filters (Standard)
- 6. F7 filters / electrostatic filters (Optional)
- 7. H2O heating coil / Rec. from food refrigeration/Heating elements (Optional)
- 8. Air treatment exchanger
- 9. Re-heating coil (Optional)
- 10. Electric fan (Supply) - return
- 11. Power input
- 12. Outdoor air damper (CBK,CCK and CCKP config.)
- 13. Access for inspection of coils, filters, heating elements
- 14. Lifting brackets (removable)
- 15. Humidifier connections
- 16. H2O heating coil input Ø 2" / Input of rec. from food refrigeration coil Ø 2" (Optional)
- 17. H2O heating coil output Ø 2" / Output of rec. from food refrigeration coil Ø 2" (Optional)
- 18. Exhaust electric fan (CCK and CCKP config.)
- 19. Exhaust air recovery coil (CCKP config.)
- 20. Exhaust air dampers (CCK and CCKP config.)
- 21. Plate exchanger
- 22. Plate exchanger water input 4"
- 23. Plate exchanger water output 4"
- 24. Outdoor air return cap, accessory disassembled supplied
- (RO) Horizontal air return
- (R3) Floor air return (Optional)
- (W0) Horizontal air supply
- (M3) Downward airflow (Optional)
- (M5) Upward airflow (Optional)
- (AE) Outdoor air return (CBK,CCK and CCKP config.)
- (ES) Air exhaust (CCK and CCKP config.)
- (**) Suggested clearance
- (**) Vibration mounts position

Size	60.4	60.4	70.4	70.4	70.4	80.4	80.4	80.4
Configuration	CAK/CBK	CCK	CAK/CBK	CCK	CCKP	CAK/CBK	CCK	CCKP
W1 supporting point	kg 706	703	721	753	804	830	862	892
W2 Supporting point	kg 692	695	707	744	800	814	851	889
W3 Supporting point	kg 583	585	595	627	674	685	717	749
W4 Supporting point	kg 608	606	622	649	692	715	742	768
Operating weight	kg 2613	2613	2740	2800	2997	3074	3202	3328
Shipping weight	kg 2589	2589	2716	2773	2970	3044	3172	3298

The presence of optional accessories may result in a substantial variation of the weights shown in the table.

Size 90.4 - 100.4 - 110.4 - CAK,CBK, CCK and CCKP configurations

DAA7W90.4_CAK-CBK-CCK-CCKP_1 REV01
DATA/DATE 21/12/2018

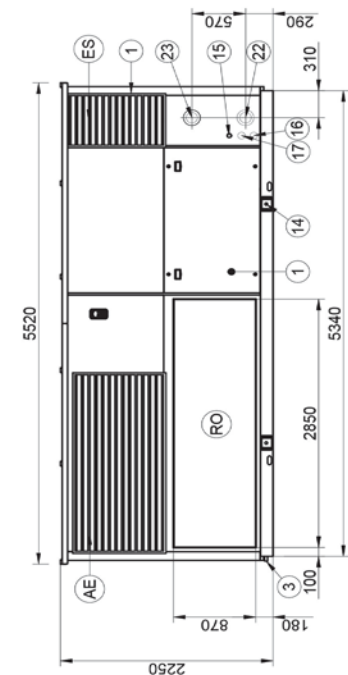
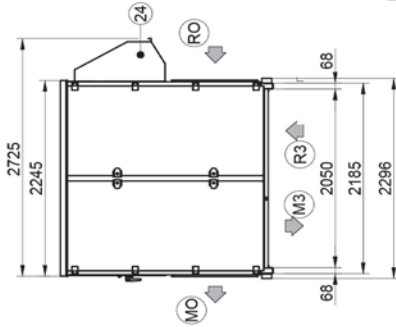
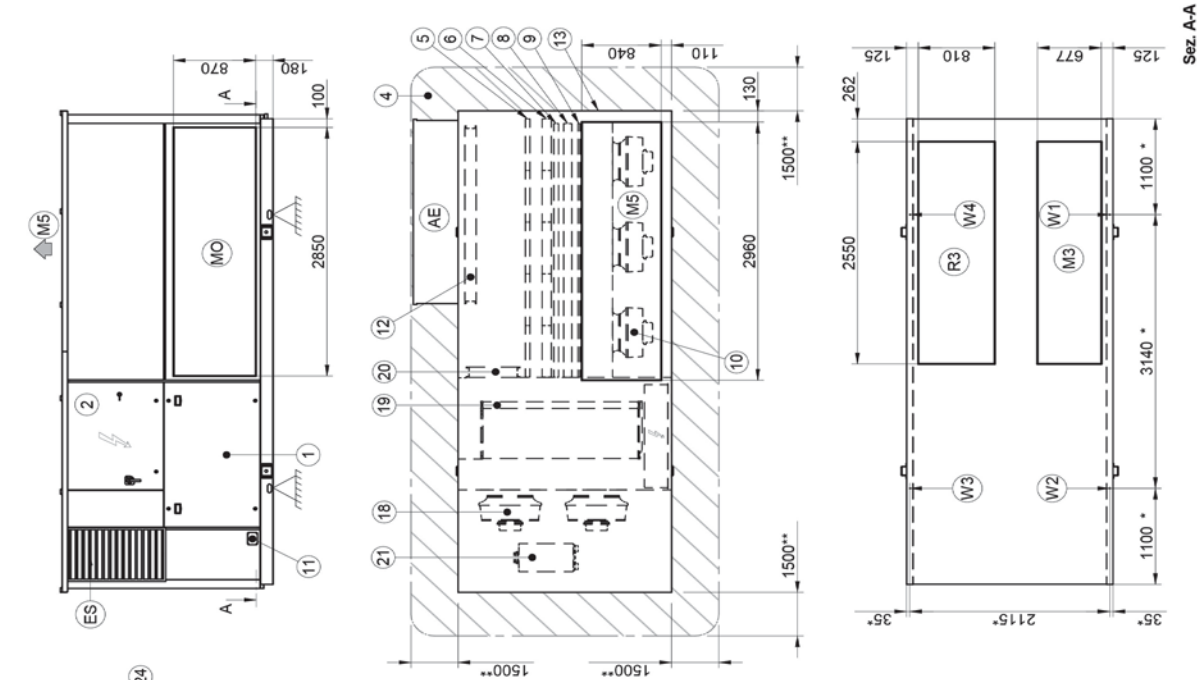

1. Compressor compartment and panel for exchanger inspection
 2. Electrical panel
 3. Condensate drain
 4. Functional clearances
 5. G4 air filters (Standard)
 6. F7 filters / electrostatic filters (Optional)
 7. H2O heating coil / Rec. from food refrigeration/Heating elements (Optional)
 8. Air treatment exchanger
 9. Re-heating coil (Optional)
 10. Electric fan (Supply - return)
 11. Power input
 12. Outdoor air damper (CBK,CCK and CCKP config.)
 13. Access for inspection of coils, filters, heating elements
 14. Lifting brackets (removable)
 15. Humidifier connections
 16. H2O heating coil input 0.2" / Input of rec. from food refrigeration coil 0.2" 1/2 (Optional)
 17. H2O heating coil output 0.2" / Output of rec. from food refrigeration coil 0.2" 1/2 (Optional)
 18. Exhaust electric fan (CCK and CCKP config.)
 19. Exhaust air recovery coil (CCKP config.)
 20. Exhaust air dampers (CCK and CCKP config.)
 21. Plate exchanger
 22. Plate exchanger water input 4"
 23. Plate exchanger water output 4"
 24. Outdoor air return cap, accessory disassembled supplied
- (RO) Horizontal air return
(R3) Floor air return (Optional)
(M0) Horizontal air supply
(M3) Downward airflow (Optional)
(M5) Upward airflow (Optional)
(AE) Outdoor air return (CBK,CCK and CCKP config.)
(ES) Air exhaust (CCK and CCKP config.)
(**) Suggested clearance
(*) Vibration mounts position

Size	90.4	90.4	90.4	100.4	100.4	100.4	110.4	110.4	110.4
Configuration	CAK/CBK	CCK	CCKP	CAK/CBK	CCK	CCKP	CAK/CBK	CCK	CCKP
W1 supporting point	kg 875	kg 907	kg 946	kg 931	kg 962	kg 1002	kg 1072	kg 1103	kg 1143
W2 Supporting point	kg 859	kg 896	kg 943	kg 913	kg 951	kg 999	kg 1052	kg 1090	kg 1137
W3 Supporting point	kg 722	kg 754	kg 795	kg 768	kg 801	kg 841	kg 885	kg 918	kg 958
W4 Supporting point	kg 754	kg 781	kg 816	kg 803	kg 829	kg 863	kg 924	kg 950	kg 983
Operating weight	kg 3245	kg 3373	kg 3535	kg 3461	kg 3589	kg 3751	kg 3987	kg 4115	kg 4275
Shipping weight	kg 3210	kg 3338	kg 3500	kg 3415	kg 3543	kg 3705	kg 3933	kg 4061	kg 4221

The presence of optional accessories may result in a substantial variation of the weights shown in the table.

**CLIVET SPA**

Via Camp Lonc 25, Z.I. Villapaiera - 32032 Feltre (BL) - Italy
Tel. + 39 0439 3131 - Fax + 39 0439 313300 - info@clivet.it

CLIVET GROUP UK Limited

Units F5&F6 Railway Triangle Ind Est, Walton Road - Portsmouth, Hampshire - PO6 1TG - United Kingdom
Tel. + 44 (0) 1489 572238 - Fax. +44 (0) 2392 381243 - enquiries@clivetgroup.co.uk

CLIVET ESPAÑA S.A.U.

C/ Bac de Roda, 36 - 08019 Barcelona - España
Tel: +34 93 8606248 - Fax +34 93 8855392 - info@clivet.es

Av.Manoteras N° 38, Oficina C303 - 28050 Madrid - España
Tel. +34 91 6658280 - Fax +34 91 6657806 - info@clivet.es

CLIVET GmbH

Hummelsbütteler Steindamm 84, 22851 Norderstedt - Germany
Tel. + 49 (0) 40 32 59 57-0 - Fax + 49 (0) 40 32 59 57-194 - info.de@clivet.com

CLIVET RUSSIA

Elektrozavodskaya st. 24, office 509 - 107023, Moscow, Russia
Tel. + 74956462009 - Fax + 74956462009 - info.ru@clivet.com

CLIVET MIDEAST FZCO

Dubai Silicon Oasis (DSO), High Bay Complex, Office N. 20, PO BOX 342009, Dubai, UAE
Tel. + 9714 3208499 - Fax + 9714 3208216 - info@clivet.ae

CLIVET AIRCONDITIONING SYSTEMS PRIVATE LIMITED

501/502, Commercial-1, Kohinoor City, Old Premier Compound, Kirol Road, Off L B S Marg, Kurla West - Mumbai 400 070 - India
Tel. +91 22 30930250 - info.in@clivet.com

www.clivet.com
www.clivetlive.com

A Group Company of

