

# SPINchiller<sup>3</sup>

High efficiency air-cooled liquid chiller  
for outdoor installation

## WSAT-XSC3 90.4-240.4 RANGE

Nominal cooling capacity from 268 kW to 678 kW

- ▶ R-410A multiscroll technology
- ▶ Two independent refrigeration circuit
- ▶ Total/partial recovery of the condensing heat



## EXCELLENCE version

- ▶ Eurovent Class A / Up to 52°C outdoor air temperature / Perfect for LEED

## PREMIUM version

- ▶ Eurovent Class C / Compact version



Clivet is taking part in the EUROVENT certification programme.  
The products concerned appear in the certified products list of the EUROVENT  
[www.eurovent-certification.com](http://www.eurovent-certification.com) site.

# Clivet hydronic system

Designed to provide high energy efficiency and sustainability of the investment, the wide range of Clivet liquid chillers and heat pumps for high efficiency air conditioning of Residential and Commercial spaces and for Industrial applications it is available with air or water source.

## HYDRONIC System - Air Source

Piccolo e Medio Terziario			Grande Terziario e Industria		
ELFOEnergy Extended Inverter ELFOEnergy Duct Inverter/Horus/Vulkan	ELFOEnergy Medium / Large / Vulkan Medium ELFOEnergy Duct Medium	ELFOEnergy Magnum	SPINchiller <sup>3</sup> / SPINchiller Duct Modular Scroll Technology		SCREWLine <sup>3</sup>
5 ÷ 50 kW	25 ÷ 250 kW	50 ÷ 375 kW	120 ÷ 680 kW	690 ÷ 1480 kW	460 ÷ 1550 kW
Refrigeratori WSAT-XIN EXC A PRM D	WSAT-XEE EXC A PRM C	WSAT-XIN EXC A PRM D WSAT-XEM EXC A PRM D WSAT-XEM HA EXC A	WSAT-XSC3 EXC A PRM C	WSAT-XSC3 EXC A PRM C	WDAT-SL3 EXC A PRM C
Refrigeratori Alta Temperatura Aria Esterna WSAT-XIN EXC A PRM D	WSAT-XEE (F-Q) A C	WSAT-XEM FC EXC A	WSAT-XSC3 EXC A	WSAT-XSC3 EXC A	WDAT-SL3 EXC A
Refrigeratori Free-Cooling WSAN-XIN EXC A PRM B HORUS A	WSAN-XEE A B	WSAN-XIN EXC A PRM D WSAN-XEM EXC A PRM D	WSAT-XSC3 FC EXC A PRM C	WSAT-XSC3 FC EXC A PRM C	WDAT-SL3 FC EXC A PRM C
Pompe di calore Alta Temperatura Acqua WBAN A HORUS+ A	WBAN A	WSAN-XEM-HV EXC A	WSAN-XSC3 EXC A	WSAN-XSC3 EXC A	
Pompe di calore Multifunzione WSA-XIN EXC A PRM B WSN-XIN EXC A PRM B	WSA-XEE A WSN-XEE A	WSA-XIN MF EXC A WSN-XEM MF EXC A	WSA-XSC3 MF EXC A	WSA-XSC3 MF EXC A	
Unità canalizzate WSA-XIN EXC A PRM B WSN-XIN EXC A PRM B	WSA-XEE A WSN-XEE A	WSA-XIN MF EXC A WSN-XEM MF EXC A	WSA-XSC2 A	WSA-XSC2 A	

## Specialization

Every intended use has specific requirements which determine the overall efficiency. For this, the Clivet hydronic system always offers the best solution in every project.

- Modular range with over 8000 kW of overall capacity
- Capacity control with Screw and modular Scroll technology
- Multifunction versions
- Outdoor or indoor (ductable type) installation

### Centrality of the Air Renewal

From the Air Renewal depends the comfort in the spaces. Since it often represents the main building energetic load, it also determines the running costs of the entire system.



**ZEPHIR3**  
Packaged Primary Air supply system with thermodynamic energy recovery.

- Simplifies the system, reduces the heating and cooling generators
- Purifies the air with standard electronic filters
- Increases the energy efficiency and it also allows a savings of 40% on the running costs
- From -40°C to +50°C of outdoor air temperature

### Terminal and AHU complete system

The hydronic terminal units are very diffused for their versatility and reliability. The Clivet range includes many versions that simplify the application in different types of installation and building.



**ELFOspace**  
High energy efficiency hydronic terminal units

**AQX**  
Air-conditioning unit

- Cased and uncased terminal units, from 1 to 90 kW
- Horizontal and vertical installation
- Energy-saving DC fans
- Modular air conditioning units up to 160.000 m<sup>3</sup>/h
- EUROVENT certification

## SPINchiller<sup>3</sup>: modular scroll technology for every application

SPINchiller<sup>3</sup> is the new generation of Clivet liquid chillers and heat pump with modular scroll technology. Thanks to its high seasonal efficiency and range versatility, it represents the ideal solution for different types of installation.

### WSAT-XSC3

#### Air cooled water chiller

- EXCELLENCE high efficiency version and PREMIUM compact version
- Operating with 52°C of outdoor air temperature
- Total / partial recovery of the condensing heat
- Eurovent certification



### WSAT-XSC3 FREE-COOLING

#### Air cooled water chiller with FREE-COOLING

- Direct FREE-COOLING
- Indirect FREE-COOLING (No-Glycol)



Dedicated series separately documented

### WSAN-XSC3

#### Air cooled heat pump

- EXCELLENCE high efficiency version
- Eurovent certification



Dedicated series separately documented

### WSAN-XSC3 Multifunction

#### Air cooled heat/cool heat pump with simultaneous operating

- EXCELLENCE high efficiency version
- 4-pipe system
- 2-pipe system and total condensing heat recovery



Dedicated series separately documented

## Cost or reliability?

### The dilemma of modern system engineering applications

Air-conditioning systems in trade centres influence both the starting investment and monthly management costs, for the whole of their working lives. This theme is even more relevant in residential applications with centralised systems. Furthermore, maximum working flexibility requirements should be added to that, in serving different users while avoiding wasting energy and thus, money. Finally, there are several industrial applications which require hot or chilled water as service fluid, process fluid or vector fluid for operator comfort and for conserving goods and enabling cycles to function correctly. Furthermore, in all these cases, the working reliability of the system is decisive.



## High efficiency hydronic systems

### The high efficiency hydronic systems are extremely versatile, reliable and widespread

Despite their apparently low costs, split, multi-split and VRF direct expansion systems have a lot of limits in these applications. For example, they require a separate system for primary air treatment. The pipes that contain the refrigerant cross the served rooms and therefore they are subject to restrictions and use limitations. They cannot operate in the FREE-COOLING mode, the high efficiency and convenient mode that allows energy savings.

The hydronic systems are certainly more complete and versatile. They make it possible to adopt various types of terminals in the served environment, from fan coil units exposed or integrated in the furnishings, up to radiant or induction systems. They are also irreplaceable in the service and process industrial applications.

The main component performances, like air-cooled liquid chillers and hydronic heat pumps, are checked and certificated by appropriate certification programs, as Eurovent.



## Clivet technological evolution

### Clivet chillers reduce consumption and are compact and reliable

With over twenty years of technological evolution, Clivet liquid chillers and heat pumps represent the state of the art in air-conditioning of residential, trade and industrial environments.

Their success is based on high energy efficiency, compactness and management maintenance simplicity, with wide versatility in the choice of the most suitable model for the specific use.





# SPINchiller<sup>3</sup>

## Provides all Clivet technological developments for their medium capacity hydronic systems

High efficiency Scroll compressors, high performance heat exchangers, electronic control fans, fully automatic operation: these are only some of the technologies available with SPINchiller<sup>3</sup>, in a range of models that are ideal for high capacity air conditioning systems in commercial, residential and industrial buildings.

The two available versions allow to choose the best combination between the initial investment and the costs throughout the entire life cycle of the system.



- the EXCELLENCE SC version stands out for its extremely high energy efficiency under both part and full load conditions. (A- class Eurovent certification)
- the distinctive feature of the PREMIUM version is its compactness and high part-load efficiency.

SPINchiller<sup>3</sup> can also be supplied in many configurations equipped with the main components installed built-in.

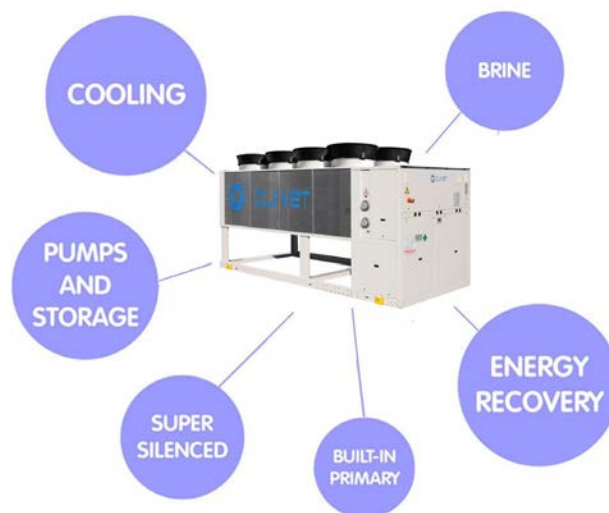

## Advantages

### High efficiency all year round

SPINchiller<sup>3</sup> reduces yearly energy consumption thanks to its high part-load efficiency i.e., by far the most frequent condition throughout the system's life-cycle. This way, even the value of the served building increases. The main components are manufactured on an industrial scale, with maximum manufacturing reliability and can be easily found as spare parts.

To further increase energy efficiency in a system with several SPINchiller<sup>3</sup> units operating on the same equipment, there is the innovative ECOSHARE feature, which automatically distributes the load and activates the necessary pumps.

### System simplification

All of the features are provided by Clivet already assembled and tested built-in, differently then other manufacturers who make numerous additional components available to be installed on site.

### Compact and versatile

Suitable for any type of terminals, from fan coils to radiant systems and chilled beams, SPINchiller<sup>3</sup> is also available in Super-silenced configuration. Energy recovery for producing hot water free of charge, FREE-COOLING. Seasonal energy efficiency is further increased with the DST operating logic, which maintains a constant return temperature.

### Borderless multiscroll technology

With SPINchiller<sup>3</sup> the modular scroll compressor technology reaches the best levels of performance and versatility ever, guaranteeing competitiveness in more and more demanding applications. The top class seasonal efficiency rewards SPINchiller<sup>3</sup> in comparison to any other air cooled chiller technology. A comparison with three SPINchiller<sup>3</sup> competitors such as:

- air cooled liquid chillers with magnetic bearing centrifugal compressors
- air cooled liquid chillers with modulating capacity screw compressors
- air cooled liquid chillers with inverter screw compressors;

shows that SPINchiller<sup>3</sup> is the best solution, considering its seasonal efficiency similar to the inverter screw chillers and a capital cost lower than that of centrifugal compressor chillers, even considering the capital investment pay back, that for analyzed technologies are always above acceptable values normally considered for system investment equal to 3 years.

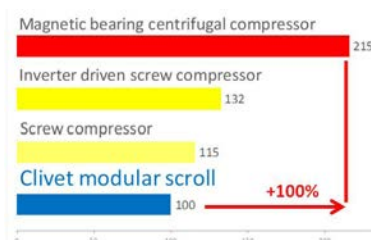
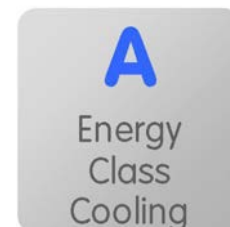

Average capital investment for 500 kW installation proportional with scroll technology

# Comfort and energy saving in one solution

## Maximum efficiency is necessary with a part load

The system is required to generate maximum capacity only for a short amount of time.

Therefore, it is essential to have the maximum efficiency under part-load conditions.

This is the only way to actually reduce overall yearly consumptions.

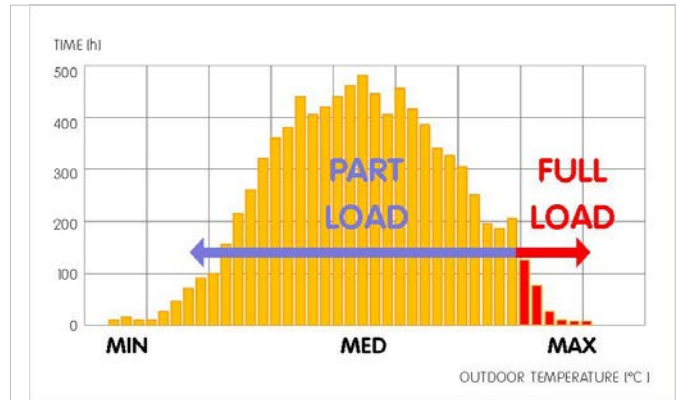

## Part load efficiency determines the seasonal efficiency

Seasonal efficiency is conventionally represented by ESEER parameters according to Eurovent and IPLV parameters according to ARI. Both give great importance to part load operation, since it is the predominant condition.

CARICO IMPIANTO	PESO (ESEER) *	PESO (IPLV) *
100%	3%	1%
75%	33%	42%
50%	41%	45%
25%	23%	12%

\* EUROVENT (ESEER) supply times reference and ARI (IPLV) reference for seasonal efficiency calculations.

## SPINchiller technology enhances part-load efficiency

SPINchiller<sup>3</sup> uses high efficiency Scroll compressors.

The advantages are:

- compressors manufactured in large ranges on an industrial scale with strict quality control inspections and maximum manufacturing reliability thanks to the high production volumes.
- every refrigeration circuit uses two Scroll compressors, depending on the different sizes of the unit. When two compressors are used, their sizes are different in order to obtain more control steps. This way, only the necessary energy is supplied.

## Doubled efficiency

The heat exchange surface is sized for full capacity operation. Under part load condition, some compressors are automatically deactivated. Under this condition, in fact, the compressors in operation make use of a much larger surface.

This entails a reduced condensation temperature and an increased evaporation temperature. This way, the compressor capacity consumption is reduced with respect to the yield thereby increasing the overall efficiency of the unit.

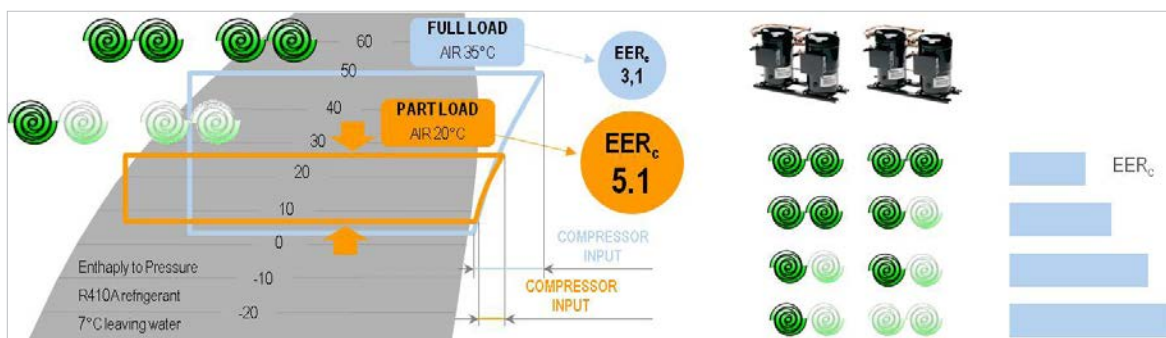

EERc = Energy efficiency referred to compressors

# Efficient and silent ventilation technology

## Advanced aerofoil fans

The external axial fans are equipped with the innovative Winglet airfoil-vane with integrated baffle, able to increase the aerodynamic efficiency.

It results in a consumption reduction of the 10% and a medium sound emission lower of 6 dB than the traditional fans.

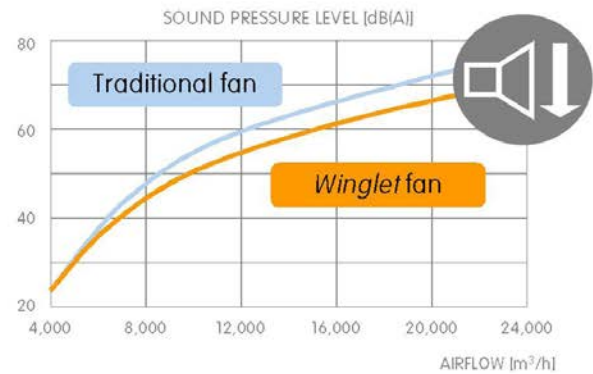
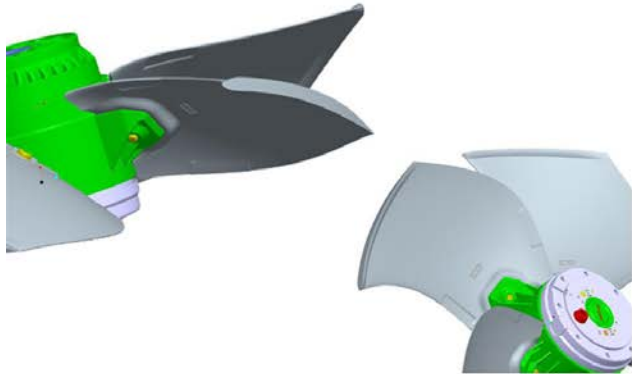

## Diffusers for fans

Also the innovative air handling system on the external exchangers is the result of the Clivet design evolution.

The new AxiTop diffuser creates an ideal air distribution: it aerodynamically decelerates the flow and transforms a big part of its dynamic energy in static pressure, obtaining:

- -3 dB of sound reduction
- reduction of 3% of the absorbed energy

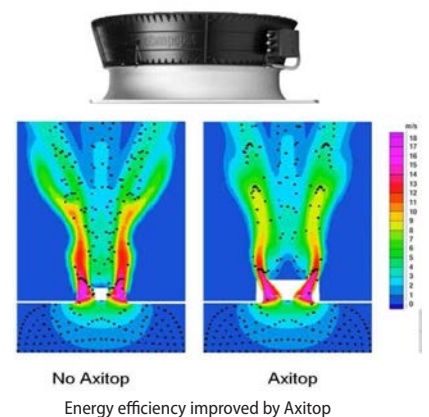

## Fans at variable speed for minimal noise emission

All SPINchiller<sup>3</sup> units are equipped with electronic condensation control. It automatically reduces the fan speed when the heat load is reduced. Since the fans are the unit's main noise source, the benefits are evident especially during the night hours, when the load is reduced but sensitivity to noise is enhanced. All this translates into a sound pressure reduced down to 8 dB(A) compared to full load operation in 90% of operating time of the unit.

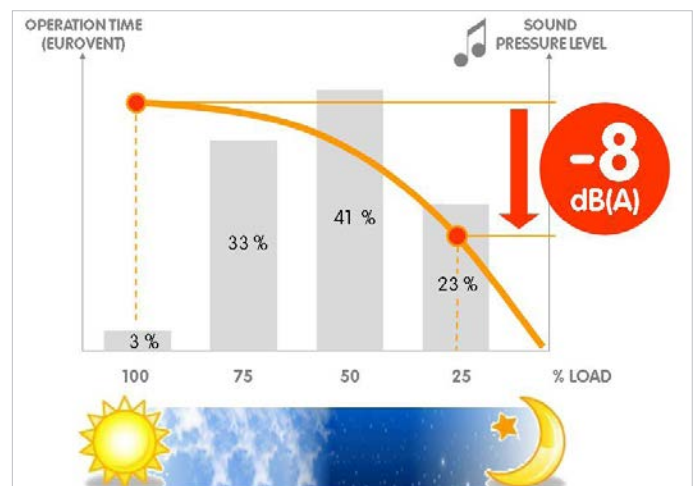

## Two versions available for the various investment dynamics

### Business oriented

All SPINchiller<sup>3</sup> models feature high part-load energy efficiency, which means high ESEER seasonal efficiency. The two versions available allow choosing the best combination between the initial investment and the costs throughout the entire life-cycle of the system.

### Excellence version: maximum efficiency

Apart from the high seasonal efficiency, the standard EXCELLENCE SC version stands out for its extremely high energy efficiency ratio (EER) during full-load cooling, which exceeds the value 3.1 and places it in Eurovent Energy Efficiency class A.

This is all possible thanks to Scroll modular technology, high efficiency heat exchangers, to the speed electronic control of the phase cutting fans and to Axitop diffusers and to an electronic control device supplied as standard.

This allows for:

- energy efficiencies equal to or higher than most units on the market equipped with screw compressors, even when inverter driven
- efficient use even in a large number of industrial and process applications
- upgrade of the building's energy class and, therefore, increased value
- maximum savings on running and maintenance costs.



With Eurovent's implementation of the EN14511:2011 standard in 2012, reaching top energy efficiency levels at full load means calculating performance by also taking into account the energy consumption required to overcome pressure drops to allow for the circulation of the solution inside the exchangers.

### Premium version: compact and aggressive

The optional PREMIUM version also develops excellent part-load efficiency, but features a compact design for the heat exchangers and structure. Therefore this solution is intended for applications that favour the initial investment rather than overall cost reduction throughout the lifespan of the system.





# Superior flexibility and reliability

## Efficient precision

Sequential activation of SPINchiller<sup>3</sup> compressors allow:

- adapting to the load required for use, thereby ensuring added comfort
- reducing the number of compressor start-ups, i.e., the main cause of wear
- increasing the unit's useful life
- reducing repair times and costs, thanks to the modular components, their reduced dimensions and reduced cost compared to semi-hermetic compressors.

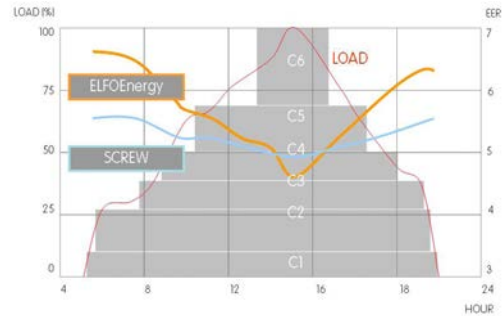

THE NUMBER OF START-UPS DECREASES THEREFORE THE LIFE CYCLE INCREASES

## Stable and reliable operation

The electronic expansion valve (EEV) adapts rapidly and precisely to the actual load required for usage, allowing stable and reliable adjustment in comparison with mechanical thermostatic valves (TEV). This results also in a further increase in efficiency and longer compressor life.

The overheating control allows preventing phenomena that are hazardous to the compressors, such as overtemperature and return fluids, thereby increasing even more efficiency and durability.

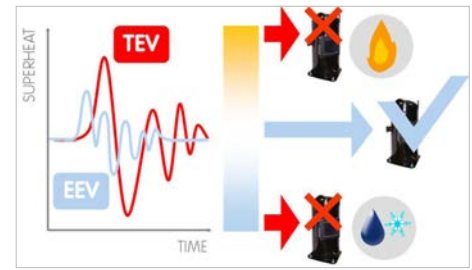

## Simplified maintenance

Besides being efficient, SPINchiller<sup>3</sup> improves the system maintenance.

In fact, the malfunction of a compressor does not compromise overall operation.

Furthermore, Scroll compressors are very compact, easy to find and easy to handle in case of replacement.



## Controlled power supply

Proper power supply ensures optimal unit operation and protects its many electrical components.

The phase monitor, standard supplied in the EXCELLENCE and PREMIUM versions:

- controls the presence and the exact sequence of the phases
- checks any voltage anomalies (-10%)
- automatically restarts the unit as soon as the proper power supply is restored.

The EXCELLENCE version is fitted with a multifunction monitor, where limit values and the service schedule of Clivet's Technical Support can be modified.



# The automatic control device coordinates resources ensuring maximum efficiency

## Operating completely automatic

The microprocessor control automatically manages operation according to the maximum efficiency criterion and includes many safety and alarm management functions.

It also includes advanced functions, such as daily and weekly programming and automatic maximum power consumption limitation (demand limit).



## Perfect for LEED certification

The whole EXCELLENCE range satisfies both requirements 2 (Minimum Energy Performance) and 3 (Fundamental Refrigerant Management) of Energy and Atmosphere section. They also meet Credit 4 parameters (Enhanced Refrigerant Management) allowing 1 point acquisition.

Clivet is committed in promoting the green building principles and has become a member of GBC Italia. This organization collaborates with USGBC, the U.S. nonprofit organization that promotes worldwide the LEED system of independent certification.



## Modularity

In the event of particularly large buildings requiring high capacities, it is advisable to use several units.

The SPINchiller<sup>3</sup> units are designed to be connected in parallel in modular logic, thereby granting the following advantages:

Increased flexibility, enhanced by the control that can adapt to the load

Increased reliability, since the malfunction of one unit does not compromise the capacity supply of the other units.

Increased efficiency, since energy is produced where and when required, according to the served area.

The microprocessor control combined with ECOSHARE allows controlling up to 7 units in local network (1 Master unit and 6 Slave).

MODULAR SYSTEM THAT ENHANCES SPINchiller<sup>3</sup> TECHNOLOGY ADVANTAGES

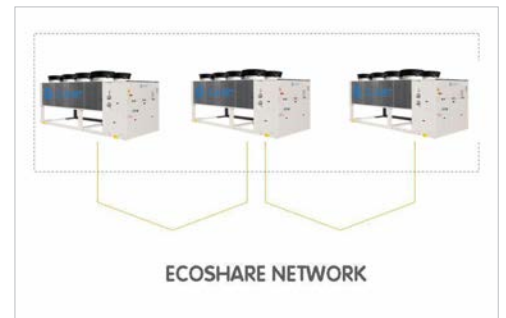

## Remote system management

SPINchiller<sup>3</sup> is standard equipped with:

- potential-free contact for remote on/off control
- potential-free contacts for remote display of the compressor status
- setting from user interface: Off / local On / serial On
- potential-free contact to remote any possible alarm

The various communication protocols allow the unit to exchange information with the main supervision systems by means of serial connections.



## Energy measuring

Monitoring energy consumption and instant power employed is the starting point to improve the system's energy management and efficiency. With the optional energy meter, the user displays all the information related to the unit's electrical parameters on the interface built-in the unit or via the serial connection.

Moreover, the integration with the Demand Limit function supplied as standard allows to act on consumption levels by limiting them if they exceed the expected limit.



# Seasonal energy efficiency is further increased with the DST operating logic

SPINchiller<sup>3</sup> is equipped with standard DST control (Dynamic Supply Temperature) control logic, which can be activated by the user.

Unlike the traditional control logic that aims at maintaining the water supply temperature constant, the DST logic aims at keeping constant the water return temperature, modifying the supply temperature dynamically according to the load. This way, evaporation temperature increases during part-load cooling, thereby increasing seasonal energy efficiency.

The DST control allows a considerable consumption and operation costs reduction, especially in civil applications, upon verification of the air treatment system's dehumidification capacity during cooling at part load.

The DST control allows considerable consumption and operation costs reduction, especially in civil applications, upon verification of the air treatment system's dehumidification capacity during part-load cooling. The DST control is particularly interesting when combined with active thermodynamic fresh air systems. The direct expansion circuit allows them to operate the outdoor air treatment independently from SPINchiller<sup>2</sup>, which can vary the system water supply temperature, thereby optimising energy efficiency in the yearly cycle.

The DST control logic is as an alternative to the control logic at variable flow-rate.



## Example

The following diagram represents the various operating temperatures in the production of chilled water under various load conditions for a typical civil system consisting of:

- primary circuit with constant water flow rate
- secondary circuit with variable water flow-rate according to the load (linear variability for simplicity).

The traditional control logic keeps the water supply temperature to room terminals and outdoor air treatment units constant, in order for the latter to carry out the dehumidification.

The DST control logic, on the other hand, allows increasing the system water supply temperature during part-load operation, thereby increasing seasonal energy efficiency for SPINchiller<sup>3</sup>.

The DST application must be verified during the design stage according to specific system constraints.

### Traditional control logic (system water flow rate temperature = constant)

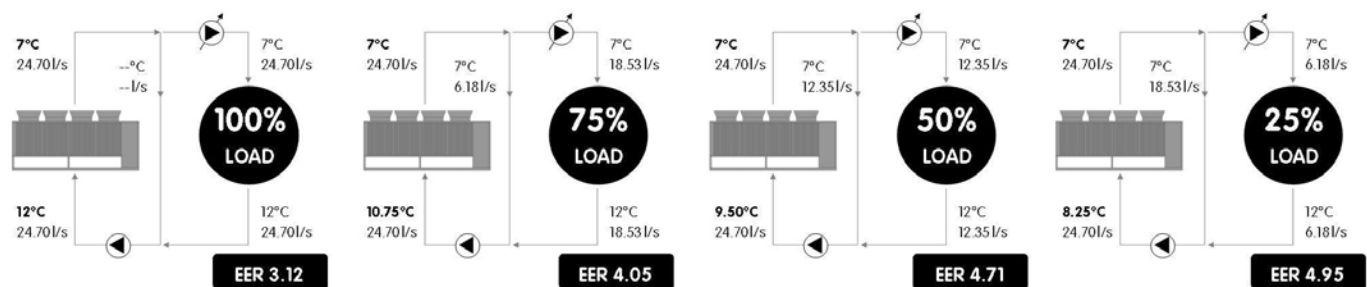

### DST control logic (system water return temperature = constant)

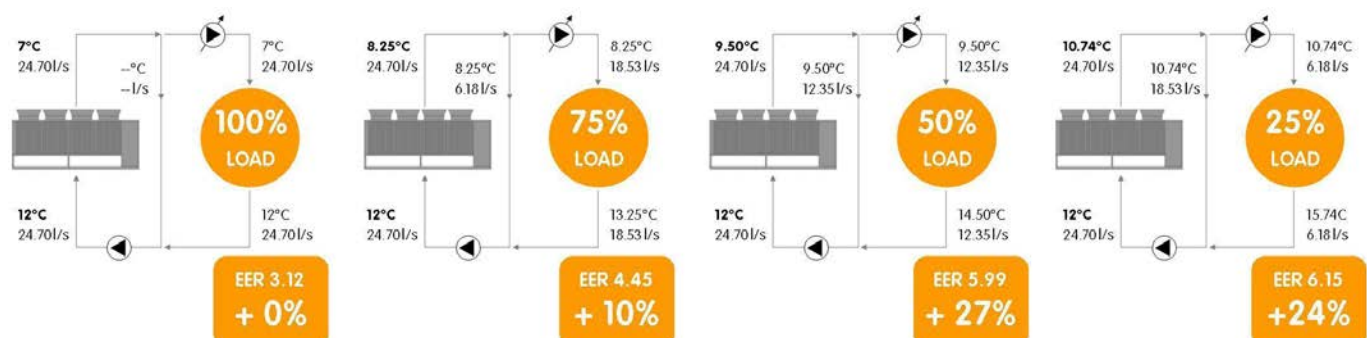

## SPINchiller<sup>3</sup> technology industrialised the system

SPINchiller<sup>3</sup> can be supplied equipped with components that are often provided separately.

This allows reducing:

- design times: all accessories are made to ensure the best overall efficiency;
- installation costs: the accessories already mechanically connected, electrically wired and individually tested are ready to be put to operate immediately;
- overall dimensions: system components are integrated with the unit, thereby reducing the technical area and increasing the area available for other uses.

### Built-in inertial accumulation available

In most SPINchiller<sup>3</sup> systems it can be installed without inertial accumulation on the system. In fact, the unit quickly adapts to the load due to modular compressors, electronic thermostatic valve and low water content plate heat exchangers. However, in the event of hydraulic distribution networks with reduced dimensions, it is important to provide the system with a hydraulic flywheel. In such cases, inertial accumulation is available built-in, equipped with insulating coating and all the necessary safety devices. This allows eliminating installation times and costs and freeing space inside the building.



### The built-in pumps are versatile, ready-for-use and reliable

The various solutions available are:

- HYDROPACK, the modular solution with two or three parallel pumps. Automatically reduces the water flow rate when in critical conditions, thereby preventing jams due to overloading, requiring the subsequent intervention of specialised technical personnel.
- it is very useful during start-ups, when restarting after operating breaks (e.g. at the weekend) or after a long period of inactivity.
- Inverter driven HYDROPACK allows water flow-rate-head calibration

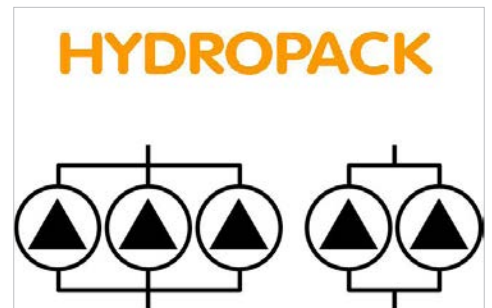

### Variable flow-rate advantages

Pumping energy for moving the water has an heavy impact on seasonal efficiency. The variable flow control is available for all units and drives to energy savings during partial load.

Pump energy consumption is proportional with cubic rotation speed. Evident the advantage when reducing flow-rate of 40% comparing to nominal conditions: energy saving is of 75% on pump energy consumption.

The control logic I based on keeping stable the water temperature entering and leaving difference, guaranteeing at the same time the best efficiency and a working envelope within an acceptable range for the heat exchanger (pressure losses).

The control logic applies to both flow-rate and compressor regulation thanks to steps. Proportional-Integral-Derivative guarantees a precise and stable operation.

The possibility of independent pump management in case of failure is embedded in the unit keeping operative the system.



## The exceptional HydroPack operation continuity

Due to its modularity, HYDROPACK maintains good water flow in the system even in the event of one of the pumps being temporarily unavailable.

In fact, with a deactivated pump, the residual flow is:

- about 80% of the rated flow (3 pump configuration)
- about 60% of the rated flow (2 pump configuration)

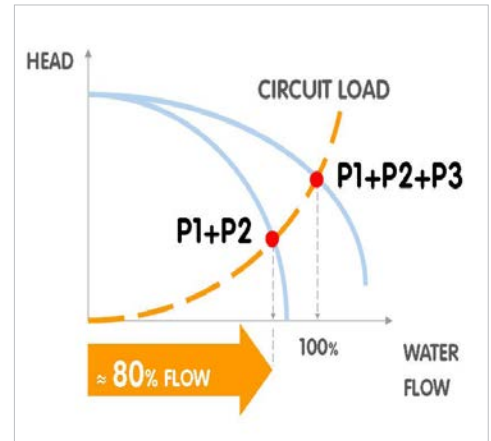

## Even the primary circuit can be integrated built-in

A connection to the secondary use circuit is all that's needed. In this way, the system results even more simple and reliable.

The units are complete with quick connections on the hydraulic side, which further reduce start-up times by eliminating pipe threading operations.

Furthermore, other system components are also available as accessories, such as hydraulic connections reported on the external walls of the unit and the required water filter.

### SPINchiller<sup>2</sup> CAN CONTAIN MOST OF THE SYSTEM COMPONENTS

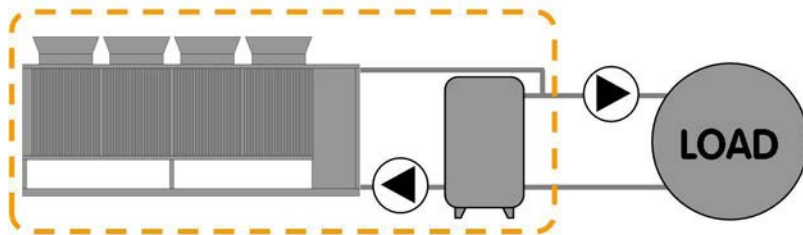

### THE QUICK CONNECTIONS ARE STANDARD SUPPLIED

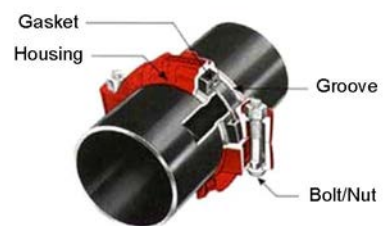

## Produces hot water freely

Condensation heat recovery:

- partial: it recovers about the 20% of the available heat (desuperheater)
- total: it recovers the 100% of the available heat

It allows the free DHW production for:

- hot water coil supply for reheat
- domestic hot water production (with intermediate exchanger)
- other processes or operations

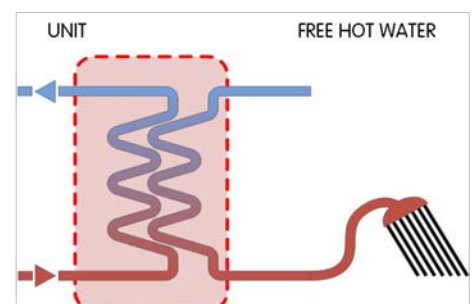

## Even for low water temperature

The unit is also perfectly adapted for use in process cooling where the low temperature version (Brine) together with the addition of glycol to the thermo-vector liquid produces chilled water down to  $-8^{\circ}\text{C}$ .

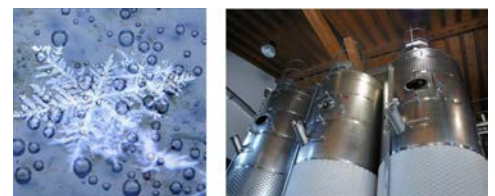

## Further considerations on the installation

The vast operating field of SPINchiller<sup>3</sup> allows it to adapt to most system applications. In some cases, special duty conditions may exceed the unit operating field. Simple devices on the system allow proper operation and meeting any requirement. Here are two examples.

### Water flow rate values outside the limits

SPINchiller<sup>3</sup> operates with constant water flow rate to the evaporator, between a minimum and maximum value indicated in the technical documents.

Flow rate values below the limit may cause unwanted formation of ice, incrustations, reduced control precision, and the unit to stop following the intervention of built-in safety devices.

Flow values above the limit may cause high pressure drops, high pumping costs, and reduced control precision, and erosion damages to the exchangers.

In this example, the required flow-rate is lower than the maximum value allowed to the evaporator, while the operating temperatures fall within the functional field of the unit.

A properly sized bypass piping resolves the problem.

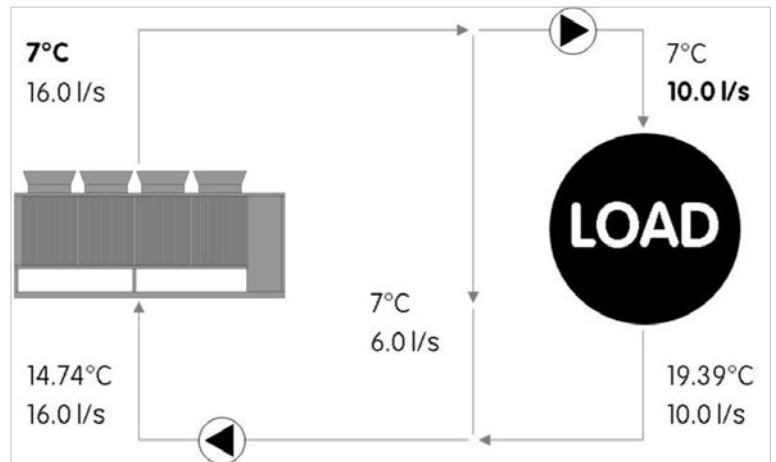

Example referred to WSAT-XSC3 180.4 SC EXCELLENCE version.  
Appropriate water flow rate for the correct unit operation.

### Temperature values outside the limits

SPINchiller<sup>3</sup> operates with the system supply temperatures indicated in the technical documentation.

Temperature limits below the limit may cause unwanted formation of ice and the unit to stop following the intervention of built-in safety devices.

Temperature values under the limit may cause malfunctions and damages to the compressors, reduced control precision, and the unit to stop following the intervention of built-in safety devices.

In this example, the required temperature exceeds the maximum value allowed to the evaporator, while the water flow rate falls within the functional field of the unit.

A properly sized bypass piping and mixing system resolve the problem.

Should both the water flow rate and the operating temperature exceed the values intended for the chiller, all you have to do is combine the two cases described above.

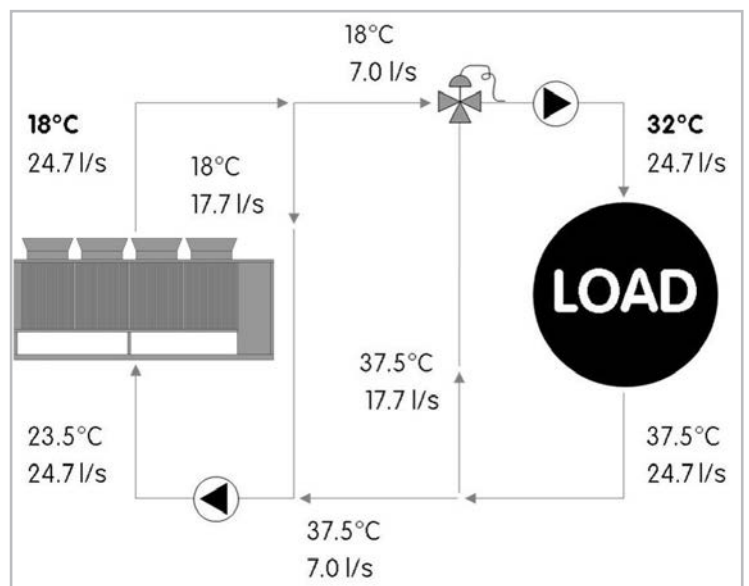

Example referred to WSAT-XSC3 180.4 SC EXCELLENCE version.  
Appropriate supply water temperature for the correct unit operation. Nominal water flow rate.

### Evaporator thermal gradient

SPINchiller<sup>3</sup> nominal capacities refer to an evaporator thermal gradient equal to 5 °C. A different thermal gradient may be used in full load operation, provided that both the operating flow and temperatures fall within the limits. As an indication, this corresponds to a minimum thermal gradient of approximately 3 °C and a maximum of 10 °C (the exact values must be determined based on the allowed flows and temperatures).

# Standard unit technical specifications - EXCELLENCE Version

## Compressor

High efficiency hermetic orbiting scroll compressor complete with oil charge, motor over-temperature and over-current devices and protection against excessive gas discharge temperature with oil heater, which starts automatically, keeps the oil from being diluted by the refrigerant when the compressor stops. Compressors, fitted on rubber antivibration mounts to prevent transmission of noise and vibration, are connected in TANDEM on a single refrigerating circuit with biphasic oil equalisation, it allows to reach high efficiency at partial load.

Uniform compression process with reduced number of moving parts which ensure very low levels of noise and vibration.

## Structure

Structure and base made entirely of sturdy sheet steel, thickness of 30/10 or 40/10, with the surface treatment in Zinc–Magnesium painted, for the parts in view, with polyester powder RAL 9001 that guarantees excellent mechanical characteristics and high corrosion strength over time.

## Panelling

External pre-painted zinc-magnesium paneling, thickness 10/10, with the surface treatment in Zinc–Magnesium painted with polyester powder RAL 9001 that ensures superior resistance to corrosion for outdoor installation and eliminates the need for periodical painting. The panels can be easily removed to fully access internal components and are lined with sound-proof material on the inside to contain the unit's sound levels.

## Internal exchanger

Direct expansion heat exchanger, braze-welded AISI 316 stainless steel plates, in pack without seals using copper as the brazing material, with low refrigerant charge and large exchange surface, complete with:

- external thermal insulation no-condensation, thickness 9,5 mm, in extruded elastomer foam with closed cells.
- differential pressure switch, water side
- antifreeze heater to protect the water side exchanger, preventing the formation of frost if the water temperature falls below a set value.

Maximum operating pressure exchanger: 10 bar on the water side and 45 bar on the refrigerant side.

## External exchanger

Finned exchanger, made from copper pipes arranged in staggered rows and mechanically expanded for better adherence to the collar of the fins. The exchangers are planned, designed and produced directly by CLIVET. The fins are made of aluminium with a special corrugated surface, set a suitable distance apart to ensure maximum heat exchange efficiency. A proper liquid supply of the expansion valve is ensured by the subcooling circuit. Each finned heat exchanger is directly cooled by the air flow of its specific fans.

## Fan

Axial fans with high performance and low-noise, balanced statically and dynamically, with blades in aluminum sheet coated in PP and sickle profile terminating with "Winglets". Wall ring in sheet steel pre-galvanised, directly coupled to the three-phase electric motor with external rotor and IP54 protection and class F insulation. Fans are located in aerodynamically shaped structures, equipped with accident prevention steel guards.

## Diffusers for external section fans - Axitop

Axitop diffusers, to be installed on the outdoor section fans, to recover dynamic energy, resulting in increased efficiency and minimal sound emission. It creates an ideal air distribution: it aerodynamically decelerates the flow and transforms a big part of its dynamic energy in static pressure. The Axitop diffuser installation is provided by the Customer.

## Device for fan consumption reduction of the external section at variable speed (phase-cutting)

Automatic device for reducing of the outdoor section consumption with variable speed fans. The speed of the fan motors is continuously adjusted according to the condensing pressure to ensure the right working of the unit at low outside temperatures.

## Refrigeration circuit

Two independent refrigeration circuits, copper made and factory-assembled, welded with continuity metallic solution, completed with:

- replaceable antiacid dehydrator filter with solid cartridge;
- liquid flow and moisture indicator;
- electronic expansion valve;
- high pressure safety pressure switch;
- high pressure safety valve;
- low pressure safety valve;
- cutoff valve on liquid line;
- cutoff valve on compressor supply.

Thermal insulated of suction line with insulation material in highly flexible closed-cell elastomer based on EPDM rubber.

Refrigeration circuit pressure tested to check leaks and supplied complete of refrigerant charge

## Configurations

D - Partial energy recovery

R - Totale energy recovery

B - Low water temperature

SC - Acoustic configuration with compressor soundproofing

EN - Super-silenced acoustic configuration

## Electrical panel

Fully constructed and wired in accordance with EN 60204.

The capacity section includes:

- main door lock isolator switch;
- terminals main power (400V / 3Ph / 50Hz);
- isolating transformer for auxiliary circuit power supply (230V/24V);
- compressor circuit breaker;
- fan overload circuit breakers;
- compressor control contactor.

The control section includes:

- interface terminal with graphic display;
- display of the set values, the error codes and the parameter index;
- ON/OFF and alarm reset buttons;
- proportional-integral-derivative water temperature control;
- daily, weekly programmer of temperature set-point and unit on/off;
- unit switching on management by local or remote (serial);
- antifreeze protection water side;
- compressor overload protection and timer;
- pre-alarm function for water antifreeze and high refrigerant gas pressure;
- self-diagnosis system with immediate display of the fault code;
- automatic rotation control for compressor starts;
- compressor operating hour display;
- remote ON/OFF control;
- relay for remote cumulative fault signal;
- input for demand limit (absorbed power limit according to an external signal 0÷10V or 4÷20mA);
- potential-free contacts for compressor status;
- digital input for double set-point enabling;
- multifunction phase monitor;
- electrical panel ventilation.

All device functions can be repeated with a normal portable PC connected to the unit with an Ethernet cable and equipped with an internet navigation browser. All electrical cables are colored and numbered in accordance with the wiring diagram

## Accessories - Hydronic assembly

- HYDROPACK (n.b.: other types are available by head)
- Inverter driven HYDROPACK
- Storage tank
- Steel mesh mechanical strainer (accessory separately provided). Note: To be located at the exchanger inlet. We disclaim any liability and make the guarantee void, if an appropriate mechanical filter is not provided inside the system.

## Accessories

- Finned coil protection grill
- Anti-hail protection grilles
- Copper / aluminium condenser coil with acrylic lining
- Copper / aluminium condenser coil with Energy Guard DCC Aluminium
- High and low pressure gauges
- Cutoff valve on compressor supply and return
- Couple of manual shut-off valves (accessory provided separately)
- Electrical panel antifreeze protection
- Multi-function phase monitor (Premium Version only)
- Power factor correction capacitors (cosφ > 0.9)
- ECOSHARE function for the automatic management of a group of units
- Disposal for inrush current reduction (SOFT STARTER)
- Serial communication module for BACnet-IP supervisor
- Serial communication module for Modbus supervisor
- Serial communication module for LonWorks supervisor
- Device for consumption reduction of the external section ECOBREEZE fans
- Device for the condensing coil partialization
- Remote control via microprocessor remote control (accessory separately supplied)
- Mains power supply unit (accessory separately supplied)
- Energy meter
- Set-point compensation with 0-10 V signal
- Set-point compensation with outdoor air temperature probe
- Spring antivibration mounts (supplied separately)
- Leak detector
- Variable flow-rate control

On special request are available:

- copper /copper condenser coil with brass shoulders
- storage tank with primary circuit with pump built-in the unit.

## Test

Unit subjected to factory-tested in specific steps and test pressure of the piping of the refrigerant circuit (with nitrogen and hydrogen), before shipping them. After the approval, the moisture contents present in all circuits are analyzed, in order to ensure the respect of the limits set by the manufacturers of the different components.

## Unit technical specifications for Premium version

Technical specifications as EXCELLENCE version, except the Phase Monitor which is at fixed calibration (multifunction optional ).



## Unit equipment with outdoor air low temperatures

Minimum outdoor air temperature		Operating unit	Unit in stand-by <sup>(5)</sup> (fed unit)	Unit in storage (unit not fed)
+11°C	1	√ standard unit	√ standard unit	√ standard unit <sup>(6)</sup>
+2°C	2			
-7°C	3			
-10°C	4			
Between -10°C and -18°C		√ electrical panel antifreeze protection √ glycol in an appropriate percentage √ device for the condensing coil partialization	√ water empty unit or with an appropriate glycol percentage √ electrical panel antifreeze protection	√ standard unit <sup>(6)</sup> <b>Not suitable:</b> X electrical panel antifreeze protection X energy meter (CONTA2) X high and low pressure gauges (MHP)
Between -18°C and -25°C		NOT POSSIBLE		√ standard unit <sup>(6)</sup> <b>Not suitable:</b> X electrical panel antifreeze protection X energy meter (CONTA2) X high and low pressure gauges (MHP)
Between -25°C and -39°C		NOT POSSIBLE		

Data referred to the following conditions:

internal exchanger water = 12/7°C

1. Part load unit and air speed equal to 1 m/s.
2. Part load unit and air speed equal to 0.5 m/s.
3. Part load unit and outdoor air temperature at rest.
4. Full load unit and outdoor air temperature at rest.

<sup>(5)</sup> The water pumping unit must be fed and connected to the unit according to the manual.

<sup>(6)</sup> Unit without water or containing water with an appropriate quantity of glycol.

At the unit start-up the water temperature or water with glycol must be inside the operating range indicated in the "Operating range" graph.

To know the water freezing temperature on varying the glycol percentage refer to the specific 'Correction factors for glycol use' table.



Air conditions which are at rest are defined as the absence of air flowing towards the unit. Weak winds can induce air to flow through the exchanger and air-levels which can cause a reduction in the operating range. In the presence of predominant winds it is necessary to use suitable windbreak barriers



The unit, with an outdoor air temperature on average lower than -10°C, can remain stored for a maximum of 1 month.

# Unit configuration

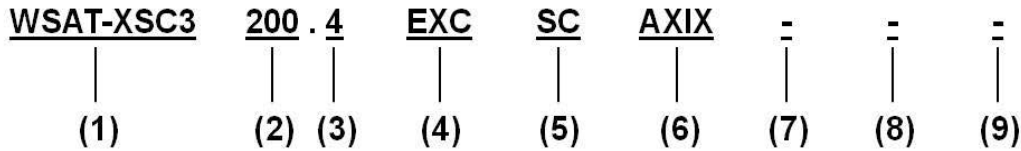

**(1) Range**  
 WSAT = Air-cooled liquid chilled with scroll compressor  
 XSC3 = SPINchiller<sup>3</sup> range

**(2) Size**  
 200 = Nominal compressor capacity (HP)

**(3) Compressors**  
 4 = Compressor quantity

**(4) Energy efficiency**  
 EXC = EXCELLENCE version: high energy efficiency  
 PRM = Compact PREMIUM version

**(5) Acoustic configuration**  
 SC = Acoustic configuration with compressor soundproofing  
 EN = Super-silenced acoustic configuration

**(6) Fan diffusers**  
 AXIX - Diffuser for high efficiency fan (standard - separately supplied)  
 NAXI - Diffuser not required

**(7) Condensation heat recovery**  
 (-) recovery not required (standard)  
 D - Partial energy recovery (15% of available heat)  
 R - Total energy recovery (100% of available heat)

**(8) Low evaporator water temperature configuration**  
 (-) Low water temperature: not required (standard)  
 B - Low water temperature, down to -8°C (Brine)

**(9) Pumping unit user side**  
 (-) not required  
 2PM - Hydropack user side with no. 2 of pumps  
 3PM - Hydropack user side with no. 3 of pumps  
 2PMV - Hydropack user side with no. 2 of inverter pumps  
 3PMV - Hydropack user side with no. 3 of inverter pumps

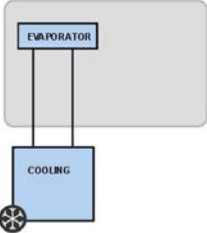
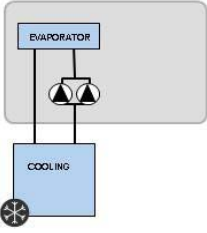
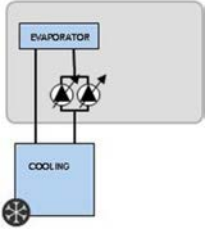
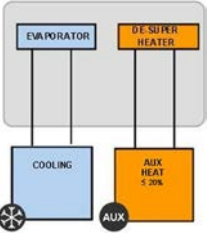
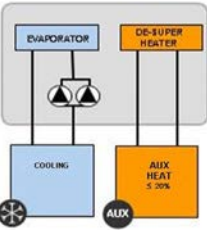
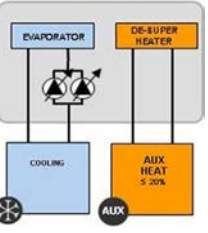
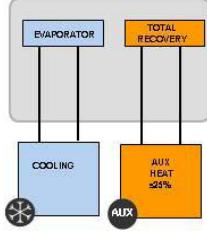
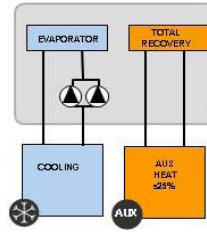
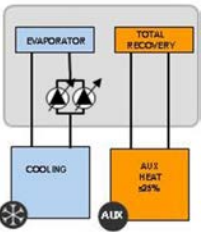
Functionalities	Hydronic units			
<b>2-PIPE SYSTEM</b> Chilled water production for installation	<b>1.1</b> Standard unit 	<b>1.2</b> Standard unit with HYDROPACK 	<b>1.3</b> Standard unit with inverter driven HYDROPACK 	
	<b>2-PIPE SYSTEM + PARTIAL RECOVERY</b> Production of chilled water Free production of hot water from partial recovery	<b>2.1</b> Standard unit with partial recovery 	<b>2.2</b> Standard unit with partial recovery and HYDROPACK 	<b>2.3</b> Standard unit with partial recovery and inverter driven HYDROPACK 
	<b>2-PIPE SYSTEM + TOTAL RECOVERY</b> Chilled water production for installation Hot water free production from total recovery	<b>3.1</b> Standard unit with total recovery 	<b>3.2</b> Standard unit with total recovery and HYDROPACK 	<b>3.3</b> Standard unit with total recovery and inverter driven HYDROPACK 

Accessories separately supplied		
• RCMRX - Remote control via microprocessor remote control	• PSX - Mains power supply unit	• AMMX - Spring antivibration mounts

# EXCELLENCE VERSION

## Acoustic configuration: compressor soundproofing (SC)



### General technical data - Performance

Size			90.4	100.4	110.4	120.4	140.4	160.4	180.4	200.4	220.4	240.4
<b>Cooling</b>												
Cooling capacity	1	[kW]	268	291	318	354	407	460	515	574	624	678
Compressor power input	1	[kW]	75	82	91	102	116	130	150	162	181	198
Total power input	2	[kW]	84,8	91,8	101	112	129	144	164	179	198	215
Partial recovery heating capacity	3	[kW]	68,6	74,6	81,7	91,2	105	118	133	147	161	175
Total recovery heating capacity	3	[kW]	325	356	391	440	501	562	643	704	775	846
EER	1	-	3,16	3,17	3,15	3,15	3,16	3,21	3,15	3,21	3,15	3,15
Water flow-rate (User Side)	1	[l/s]	12,8	13,9	15,2	16,9	19,4	22,0	24,6	27,4	29,8	32,4
Internal exchanger pressure drops	1	[kPa]	50	49	50	46	51	51	52	51	50	55
Cooling capacity (EN14511:2013)	4	[kW]	267	290	316	353	405	459	513	572	621	675
Total power input (EN14511:2013)	4	[kW]	85,8	92,9	102	114	130	145	165	181	200	218
EER (EN 14511:2013)	4	-	3,11	3,12	3,10	3,10	3,11	3,16	3,10	3,16	3,10	3,10
SEER	6	-	4,64	4,65	4,62	4,56	4,66	4,65	4,59	4,64	4,62	4,56
SEPR	7		5,30	5,34	5,46	5,37	5,15	5,18	5,46	5,46	5,29	5,39
Cooling capacity (AHRI 550/590)	5	[kW]	267	290	316	352	405	458	513	571	621	675
Total power input (AHRI 550/590)	5	[kW]	84,5	91,5	100,5	112,1	128,4	143,0	163,0	178,2	197,3	214,2
COP <sub>R</sub>	5	-	3,16	3,16	3,15	3,14	3,16	3,21	3,15	3,21	3,15	3,15
IPLV	5	-	4,82	4,90	4,86	4,87	4,95	5,06	5,05	4,92	4,89	4,96

The Product is compliant with the Erp (Energy Related Products) European Directive. It includes the Commission delegated Regulation (EU) No 2016/2281, also known as Ecodesign LOT21.

\*Contains fluorinated greenhouse gases\*(GWP 2087,5)

- Data referred to the following conditions: internal exchanger water = 12/7 °C. Entering external exchanger air temperature 35°C. Evaporator fouling factor =  $0.44 \times 10^{(-4)}$  m<sup>2</sup> K/W
- The Total Power Input value does not take into account the part related to the pumps and required to overcome the pressure drops for the circulation of the solution inside the exchangers
- Option. Recovery exchanger water=40/45°C
- Data compliant to Standard EN 14511:2013 referred to the following conditions: - Internal exchanger water temperature = 12/7°C - Entering external exchanger air temperature = 35°C
- Data compliant to Standard AHRI 550/590 referred to the following conditions: internal exchanger water temperature = 6,7 °C. Water flow-rate 0,043 l/s per kW. Entering external exchanger air temperature 35°C. Evaporator fouling factor =  $0.18 \times 10^{(-4)}$  m<sup>2</sup> K/W
- Data calculated according to the EN 14825:2016 Regulation
- Data calculated according to the EU 2016/2281 Regulation

# PREMIUM VERSION

## Acoustic configuration: compressor soundproofing (SC)



### General technical data - Performance

Size			120.4	140.4	160.4	180.4	200.4	220.4	240.4
<b>Cooling</b>									
Cooling capacity	1	[kW]	334	381	423	492	531	596	648
Compressor power input	1	[kW]	109	125	140	159	174	193	210
Total power input	2	[kW]	118	135	149	171	186	208	226
Partial recovery heating capacity	3	[kW]	89,8	102	114	131	144	160	174
Total recovery heating capacity	3	[kW]	427	486	556	627	691	767	833
EER	1	-	2,81	2,84	2,83	2,86	2,84	2,85	2,86
Water flow-rate (User Side)	1	[l/s]	16,0	18,2	20,2	23,5	25,4	28,5	31,0
Internal exchanger pressure drops	1	[kPa]	55	53	55	58	55	55	54
Cooling capacity (EN14511:2013)	4	[kW]	333	379	421	490	529	594	645
Total power input (EN14511:2013)	4	[kW]	120	136	151	174	189	211	229
EER (EN 14511:2013)	4	-	2,77	2,80	2,78	2,82	2,80	2,81	2,82
SEER	6	-	4,21	4,19	4,17	4,32	4,22	4,19	4,15
SEPR	7		5,33	5,27	5,15	5,29	5,48	5,27	5,42
Cooling capacity (AHRI 550/590)	5	[kW]	332	379	420	489	528	592	644
Total power input (AHRI 550/590)	5	[kW]	118	134	149	171	186	208	225
COP <sub>R</sub>	5	-	2,80	2,83	2,82	2,85	2,83	2,84	2,86
IPLV	5	-	4,59	4,65	4,64	4,63	4,55	4,60	4,60

The Product is compliant with the Erp (Energy Related Products) European Directive. It includes the Commission delegated Regulation (EU) No 2016/2281, also known as Ecodesign LOT21.

\*Contains fluorinated greenhouse gases\*(GWP 2087,5)

- Data referred to the following conditions: internal exchanger water = 12/7 °C. Entering external exchanger air temperature 35°C. Evaporator fouling factor =  $0.44 \times 10^{(-4)}$  m<sup>2</sup> K/W
- The Total Power Input value does not take into account the part related to the pumps and required to overcome the pressure drops for the circulation of the solution inside the exchangers
- Option. Recovery exchanger water=40/45°C
- Data compliant to Standard EN 14511:2013 referred to the following conditions: - Internal exchanger water temperature = 12/7°C - Entering external exchanger air temperature = 35°C
- Data compliant to Standard AHRI 550/590 referred to the following conditions: internal exchanger water temperature = 6,7 °C. Water flow-rate 0,043 l/s per kW. Entering external exchanger air temperature 35°C. Evaporator fouling factor =  $0.18 \times 10^{(-4)}$  m<sup>2</sup> K/W
- Data calculated according to the EN 14825:2016 Regulation
- Data calculated according to the EU 2016/2281 Regulation

# EXCELLENCE VERSION

## Acoustic configuration: super-silenced (EN)

### General technical data - Performance

Size			90.4	100.4	110.4	120.4	140.4	160.4	180.4	200.4	220.4	240.4
<b>Cooling</b>												
Cooling capacity	1	[kW]	259	280	307	341	393	438	491	549	599	642
Compressor power input	1	[kW]	78	85	95	108	120	136	160	170	191	210
Total power input	2	[kW]	85,1	92,1	102,1	115	130	146	169	182	203	222
Partial recovery heating capacity	3	[kW]	67,4	73,0	80,4	89,8	103,0	115,0	130,0	144,0	158,0	170,0
Total recovery heating capacity	3	[kW]	319	349	385	433	491	552	626	697	763	837
EER	1	-	3,04	3,04	3,01	2,96	3,03	3,01	2,90	3,02	2,96	2,90
Water flow-rate (User Side)	1	[l/s]	12,4	13,4	14,7	16,3	18,8	20,9	23,5	26,2	28,6	30,7
Internal exchanger pressure drops	1	[kPa]	47	46	47	43	48	46	47	47	46	49
Cooling capacity (EN14511:2013)	4	[kW]	258	279	306	340	392	436	489	547	597	640
Total power input (EN14511:2013)	4	[kW]	86,0	93,1	103	116	131	147	171	184	205	224
EER (EN 14511:2013)	4	-	3,00	3,00	2,96	2,92	2,99	2,97	2,86	2,98	2,92	2,86
SEER	6	-	4,61	4,62	4,58	4,55	4,62	4,59	4,55	4,59	4,58	4,55
SEPR	7		5,44	5,40	5,50	5,40	5,19	5,21	5,38	5,51	5,35	5,36
Cooling capacity (AHRI 550/590)	5	[kW]	257	278	305	339	391	435	488	546	595	638
Total power input (AHRI 550/590)	5	[kW]	84,9	91,8	102	115	129	145	169	181	202	221
COP <sub>R</sub>	5	-	3,03	3,03	3,00	2,95	3,02	3,00	2,89	3,01	2,95	2,89
IPLV	5	-	4,8	4,87	4,92	4,78	4,83	4,79	4,93	4,83	4,87	4,85

The Product is compliant with the Erp (Energy Related Products) European Directive. It includes the Commission delegated Regulation (EU) No 2016/2281, also known as Ecodesign LOT21.  
 'Contains fluorinated greenhouse gases'(GWP 2087,5)

- Data referred to the following conditions: internal exchanger water = 12/7 °C. Entering external exchanger air temperature 35°C. Evaporator fouling factor =  $0.44 \times 10^{-4}$  m<sup>2</sup> K/W
- The Total Power Input value does not take into account the part related to the pumps and required to overcome the pressure drops for the circulation of the solution inside the exchangers
- Option. Recovery exchanger water=40/45°C
- Data compliant to Standard EN 14511:2013 referred to the following conditions: - Internal exchanger water temperature = 12/7°C - Entering external exchanger air temperature = 35°C
- Data compliant to Standard AHRI 550/590 referred to the following conditions: internal exchanger water temperature = 6,7 °C. Water flow-rate 0,043 l/s per kW. Entering external exchanger air temperature 35°C. Evaporator fouling factor =  $0.18 \times 10^{-4}$  m<sup>2</sup> K/W
- Data calculated according to the EN 14825:2016 Regulation
- Data calculated according to the EU 2016/2281 Regulation

# PREMIUM VERSION

## Acoustic configuration: super-silenced (EN)

### General technical data - Performance

Size			120.4	140.4	160.4	180.4	200.4	220.4	240.4
<b>Cooling</b>									
Cooling capacity	1	[kW]	322	365	405	471	504	573	614
Compressor power input	1	[kW]	114	130	146	166	185	202	221
Total power input	2	[kW]	121	137	153	175	194	213	233
Partial recovery heating capacity	3	[kW]	89,8	102	114	131	144	160	174
Total recovery heating capacity	3	[kW]	419	480	548	622	685	758	824
EER	1	-	2,66	2,66	2,64	2,69	2,59	2,68	2,64
Water flow-rate (User Side)	1	[l/s]	15,4	17,4	19,4	22,5	24,1	27,4	29,3
Internal exchanger pressure drops	1	[kPa]	50,9	49,1	50,6	52,9	49,5	51,1	48,5
Cooling capacity (EN14511:2013)	4	[kW]	321	364	403	469	502	571	612
Total power input (EN14511:2013)	4	[kW]	122	138	155	177	196	216	235
EER (EN 14511:2013)	4	-	2,62	2,63	2,61	2,65	2,56	2,65	2,61
SEER	6	-	4,16	4,13	4,10	4,22	4,10	4,13	4,14
SEPR	7		5,37	5,33	5,23	5,31	5,50	5,33	5,48
Cooling capacity (AHRI 550/590)	5	[kW]	320	363	402	468	501	569	610
Total power input (AHRI 550/590)	5	[kW]	121	137	153	175	194	213	232
COP <sub>R</sub>	5	-	2,65	2,65	2,64	2,68	2,59	2,68	2,63
IPLV	5	-	4,54	4,53	4,50	4,52	4,50	4,57	4,52

The Product is compliant with the Erp (Energy Related Products) European Directive. It includes the Commission delegated Regulation (EU) No 2016/2281, also known as Ecodesign LOT21.  
 'Contains fluorinated greenhouse gases'(GWP 2087,5)

- Data referred to the following conditions: internal exchanger water = 12/7 °C. Entering external exchanger air temperature 35°C. Evaporator fouling factor =  $0.44 \times 10^{-4}$  m<sup>2</sup> K/W
- The Total Power Input value does not take into account the part related to the pumps and required to overcome the pressure drops for the circulation of the solution inside the exchangers
- Option. Recovery exchanger water=40/45°C
- Data compliant to Standard EN 14511:2013 referred to the following conditions: - Internal exchanger water temperature = 12/7°C - Entering external exchanger air temperature = 35°C
- Data compliant to Standard AHRI 550/590 referred to the following conditions: internal exchanger water temperature = 6,7 °C. Water flow-rate 0,043 l/s per kW. Entering external exchanger air temperature 35°C. Evaporator fouling factor =  $0.18 \times 10^{-4}$  m<sup>2</sup> K/W
- Data calculated according to the EN 14825:2016 Regulation
- Data calculated according to the EU 2016/2281 Regulation



# EXCELLENCE VERSION

## Acoustic configuration: compressor soundproofing (SC)



### General technical data - Construction

Size			90.4	100.4	110.4	120.4	140.4	160.4	180.4	200.4	220.4	240.4
<b>Compressor</b>												
Type of compressors		-	Scroll	Scroll	Scroll	Scroll	Scroll	Scroll	Scroll	Scroll	Scroll	Scroll
No. of compressors		Nr	4	4	4	4	4	4	4	4	4	4
Rated power (C1)		[HP]	45	50	55	60	70	80	90	100	100	120
Rated power (C2)		[HP]	45	50	55	60	70	80	90	100	120	120
Std Capacity control steps		-	6	6	6	4	6	4	6	6	6	4
Oil charge (C1)		[l]	10	11	13	13	13	13	13	13	13	13
Oil charge (C2)		[l]	10	11	13	13	13	13	13	13	13	13
Refrigerant charge (C1)	1	[kg]	26	33	33	33	44	44	50	54	55	65
Refrigerant charge (C2)	1	[kg]	25	32	32	32	42	43	49	53	61	63
Refrigeration circuits		-	2	2	2	2	2	2	2	2	2	2
<b>Internal exchanger</b>												
Type of internal exchanger	2	-	PHE	PHE	PHE	PHE	PHE	PHE	PHE	PHE	PHE	PHE
Water content		[l]	20	22	24	29	32	37	42	49	58	62
System water content	3	l	937	1196	1502	1819	1840	2367	1801	2359	2436	3483
<b>External Section Fans</b>												
Type of fans	4	-	AX	AX	AX	AX	AX	AX	AX	AX	AX	AX
Number of fans		Nr	6	6	6	6	8	8	8	10	10	10
Type of motor	5	-	AC/P	AC/P	AC/P	AC/P	AC/P	AC/P	AC/P	AC/P	AC/P	AC/P
Standard airflow		[l/s]	36628	36204	36187	34999	48272	46666	45657	58332	57703	57073
<b>Connections</b>												
Water fittings		-	4"	4"	4"	4"	4"	4"	5"	5"	5"	5"
<b>Power supply</b>												
Standard power supply		V	400/3~/50	400/3~/50	400/3~/50	400/3~/50	400/3~/50	400/3~/50	400/3~/50	400/3~/50	400/3~/50	400/3~/50
<b>Electrical data</b>												
FLA Total		A	205,5	216,5	233,3	262,1	299,3	328,3	379,7	416,9	457,1	497,3
FLI Total		kW	117,7	128,6	138,2	155,8	180,7	201,9	227,5	252,4	275,8	299,2
M.I.C. - Value	6	A	455,6	466,9	483,7	512,5	619,2	648,2	649,4	686,6	726,8	767,0
M.I.C. - with soft start accessory	6	A	317,8	329,1	345,9	374,7	447,2	476,2	649,4	686,6	726,8	767,0

- Indicative values for standard units with possible +/-10% variation. The actual data are indicated on the unit label
- PHE = plate exchanger
- Recommended system water content that does not consider the internal exchanger water content (evaporator). With outdoor air low temperature applications or low medium requested loads, the minimum installation water volume is obtained doubling the indicated value.
- AX = axial fan

- AC/P = asynchronous three-phase external rotor motor with phase cutting speed automatic control  
Unbalance between phase max 2% Voltage variation: max +/- 10%  
Electrical data refer to standard units; according to the installed accessories, the data can suffer some variations.
- M.I.C. = Maximum unit starting current.  
The M.I.C. value is obtained adding the max. compressor starting current of the highest size to the power input at max. admissible conditions (F.L.A.) of the remaining electric components.

### Sound levels

Size	Sound power level (dB)								Sound power level dB(A)	Sound pressure level dB(A)
	Octave band (Hz)									
	63	125	250	500	1000	2000	4000	8000		
90.4	93	90	90	88	88	85	71	62	92	72
100.4	93	90	90	88	88	85	71	62	92	72
110.4	93	90	90	88	88	85	71	62	92	72
120.4	93	90	90	88	88	85	71	62	92	72
140.4	94	91	91	89	89	86	72	63	92	72
160.4	95	92	92	90	90	87	73	64	93	73
180.4	101	97	96	93	89	84	78	72	95	74
200.4	101	97	96	93	89	84	78	72	95	74
220.4	102	98	97	94	90	85	79	73	95	74
240.4	102	98	97	94	90	85	79	73	95	75

The sound levels refer to standard unit with Axitop (no accessories) at full load, in test nominal conditions. The sound pressure level refers to 1 m. from the standard unit outer surface operating in open field.  
Measures are according to UNI EN ISO 9614-2 regulations, with respect to the EUROVENT 8/1 certification, which provides for a tolerance of 3 dB(A) on the sound power level, which is the only acoustic data to be considered binding.

If unit is set without Axitop, the sound power level presents an increase up to 3 dB(A).

Data referred to the following conditions.  
- internal exchanger water = 12/7 °C  
- Ambient temperature = 35 °C

# PREMIUM VERSION



## Acoustic configuration: compressor soundproofing (SC)

### General technical data - Construction

Size			120.4	140.4	160.4	180.4	200.4	220.4	240.4
<b>Compressor</b>									
Type of compressors		-	Scroll	Scroll	Scroll	Scroll	Scroll	Scroll	Scroll
No. of compressors		Nr	4	4	4	4	4	4	4
Rated power (C1)		[HP]	60	70	80	90	100	100	120
Rated power (C2)		[HP]	60	70	80	90	100	120	120
Std Capacity control steps		-	4	6	4	6	6	6	4
Oil charge (C1)		[l]	13	13	13	13	13	13	13
Oil charge (C2)		[l]	13	13	13	13	13	13	13
Refrigerant charge (C1)	1	[kg]	27	34	35	36	45	44	58
Refrigerant charge (C2)	1	[kg]	26	33	33	35	44	53	56
Refrigeration circuits		-	2	2	2	2	2	2	2
<b>Internal exchanger</b>									
Type of internal exchanger	2	-	PHE	PHE	PHE	PHE	PHE	PHE	PHE
Water content		[l]	24	29	32	37	42	49	58
System water content	3	l	1717	1723	2173	1720	2183	2327	3330
<b>External Section Fans</b>									
Type of fans	4	-	AX	AX	AX	AX	AX	AX	AX
Number of fans		Nr	6	6	6	8	8	10	10
Type of motor	5	-	AC/P	AC/P	AC/P	AC/P	AC/P	AC/P	AC/P
Standard airflow		[l/s]	37459	37103	36017	49946	49471	62135	60028
<b>Connections</b>									
Water fittings		-	4"	4"	4"	5"	5"	5"	5"
<b>Power supply</b>									
Standard power supply		V	400/3~/50	400/3~/50	400/3~/50	400/3~/50	400/3~/50	400/3~/50	400/3~/50
<b>Electrical data</b>									
FLA Total		A	262,1	291,1	320,1	379,7	408,7	457,1	497,3
FLI Total		kW	155,8	177,0	198,2	227,5	248,7	275,8	299,2
M.I.C. - Value	6	A	512,5	611,0	640,0	649,4	678,4	726,8	767,0
M.I.C. - with soft start accessory	6	A	374,7	439,0	468,0	649,4	678,4	726,8	767,0

- Indicative values for standard units with possible +/-10% variation. The actual data are indicated on the unit label
- PHE = plate exchanger
- Recommended system water content that does not consider the internal exchanger water content (evaporator). With outdoor air low temperature applications or low medium requested loads, the minimum installation water volume is obtained doubling the indicated value.
- AX = axial fan

- AC/P = asynchronous three-phase external rotor motor with phase cutting speed automatic control  
Unbalance between phase max 2% Voltage variation: max +/- 10%  
Electrical data refer to standard units; according to the installed accessories, the data can suffer some variations.
- M.I.C. = Maximum unit starting current.  
The M.I.C. value is obtained adding the max. compressor starting current of the highest size to the power input at max. admissible conditions (F.L.A.) of the remaining electric components.

### Sound levels

Size	Sound power level (dB)								Sound power level dB(A)	Sound pressure level dB(A)
	Octave band (Hz)									
	63	125	250	500	1000	2000	4000	8000		
120.4	93	90	90	88	88	85	71	62	92	72
140.4	94	91	91	89	89	86	72	63	92	72
160.4	95	92	92	90	90	87	73	64	93	73
180.4	101	97	96	93	89	84	78	72	95	74
200.4	101	97	96	93	89	84	78	72	95	74
220.4	102	98	97	94	90	85	79	73	95	74
240.4	102	98	97	94	90	85	79	73	95	75

The sound levels refer to standard unit with Axitop (no accessories) at full load, in test nominal conditions. The sound pressure level refers to 1 m. from the standard unit outer surface operating in open field.  
Measures are according to UNI EN ISO 9614-2 regulations, with respect to the EUROVENT 8/1 certification, which provides for a tolerance of 3 dB(A) on the sound power level, which is the only acoustic data to be considered binding.  
If unit is set without Axitop, the sound power level presents an increase up to 3 dB(A).

Data referred to the following conditions.  
- internal exchanger water = 12/7 °C  
- Ambient temperature = 35 °C

# EXCELLENCE VERSION

## Acoustic configuration: super-silenced (EN)

### General technical data - Construction

Size			90.4	100.4	110.4	120.4	140.4	160.4	180.4	200.4	220.4	240.4
<b>Compressor</b>												
Type of compressors		-	Scroll	Scroll	Scroll	Scroll	Scroll	Scroll	Scroll	Scroll	Scroll	Scroll
No. of compressors		Nr	4	4	4	4	4	4	4	4	4	4
Rated power (C1)		[HP]	45	50	55	60	70	80	90	100	100	120
Rated power (C2)		[HP]	45	50	55	60	70	80	90	100	120	120
Std Capacity control steps		-	6	6	6	4	6	4	6	6	6	4
Oil charge (C1)		[l]	10	11	13	13	13	13	13	13	13	13
Oil charge (C2)		[l]	10	11	13	13	13	13	13	13	13	13
Refrigerant charge (C1)	1	[kg]	26	33	33	33	44	44	50	54	55	65
Refrigerant charge (C2)	1	[kg]	25	32	32	32	42	43	49	53	61	63
Refrigeration circuits		-	2	2	2	2	2	2	2	2	2	2
<b>Internal exchanger</b>												
Type of internal exchanger	2	-	PHE	PHE	PHE	PHE	PHE	PHE	PHE	PHE	PHE	PHE
Water content		[l]	20	22	24	29	32	37	42	49	58	62
System water content	3	l	937	1196	1502	1819	1840	2367	1801	2359	2436	3483
<b>External Section Fans</b>												
Type of fans	4	-	AX	AX	AX	AX	AX	AX	AX	AX	AX	AX
Number of fans		Nr	6	6	6	6	8	8	8	10	10	10
Type of motor	5	-	AC/P	AC/P	AC/P	AC/P	AC/P	AC/P	AC/P	AC/P	AC/P	AC/P
Standard airflow		[l/s]	30282	29943	29943	28704	39924	38272	37345	47841	47841	46681
<b>Connections</b>												
Water fittings		-	4"	4"	4"	4"	4"	4"	5"	5"	5"	5"
<b>Power supply</b>												
Standard power supply		V	400/3~/50	400/3~/50	400/3~/50	400/3~/50	400/3~/50	400/3~/50	400/3~/50	400/3~/50	400/3~/50	400/3~/50
<b>Electrical data</b>												
FLA Total		A	205,2	216,5	233,3	262,1	299,3	328,3	379,7	416,9	457,1	497,3
FLI Total		kW	117,7	128,6	138,2	155,8	180,7	201,9	227,5	252,4	275,8	299,2
M.I.C. - Value	6	A	455,6	466,9	483,7	512,5	619,2	648,2	649,4	686,6	726,8	767,0
M.I.C. - with soft start accessory	6	A	317,8	329,1	345,9	374,7	447,2	476,2	649,4	686,6	726,8	767,0

- Indicative values for standard units with possible +/-10% variation. The actual data are indicated on the unit label
- PHE = plate exchanger
- Recommended system water content that does not consider the internal exchanger water content (evaporator).  
With outdoor air low temperature applications or low medium requested loads, the minimum installation water volume is obtained doubling the indicated value.
- AX = axial fan

- AC/P = asynchronous three-phase external rotor motor with phase cutting speed automatic control  
Unbalance between phase max 2% Voltage variation: max +/- 10%  
Electrical data refer to standard units; according to the installed accessories, the data can suffer some variations.
- M.I.C.=Maximum unit starting current.  
The M.I.C. value is obtained adding the max. compressor starting current of the highest size to the power input at max. admissible conditions (F.L.A.) of the remaining electric components.

### Sound levels

Size	Sound power level (dB)								Sound power level dB(A)	Sound pressure level dB(A)
	Octave band (Hz)									
	63	125	250	500	1000	2000	4000	8000		
90.4	87	84	84	82	82	79	65	56	86	66
100.4	87	84	84	82	82	79	65	56	86	66
110.4	87	84	84	82	82	79	65	56	86	66
120.4	88	85	85	83	83	80	66	57	86	66
140.4	88	85	85	83	83	80	66	57	86	66
160.4	89	86	86	84	84	81	67	58	87	67
180.4	96	92	91	88	84	79	73	67	90	69
200.4	96	92	91	88	84	79	73	67	90	69
220.4	97	93	92	89	85	80	74	68	90	69
240.4	97	93	92	89	85	80	74	68	90	70

The sound levels refer to standard unit with Axitop (no accessories) at full load, in test nominal conditions. The sound pressure level refers to 1 m. from the standard unit outer surface operating in open field.

Measures are according to UNI EN ISO 9614-2 regulations, with respect to the EUROVENT 8/1 certification, which provides for a tolerance of 3 dB(A) on the sound power level, which is the only acoustic data to be considered binding.

If unit is set without Axitop, the sound power level presents an increase up to 3 dB(A).

Data referred to the following conditions.

- internal exchanger water = 12/7 °C
- Ambient temperature = 35 °C

The indicated sound levels are only valid within the operating field of the standard unit at full load as indicated in the 'Operating range - cooling' graph in the "Super-silenced EN" configuration. With outdoor air temperatures the unit operates at full load automatically increasing the airflow and taking the same sound levels of the "Soundproofed Compressors SC" configuration.

# PREMIUM VERSION

## Acoustic configuration: super-silenced (EN)

### General technical data - Construction

Size			120.4	140.4	160.4	180.4	200.4	220.4	240.4
<b>Compressor</b>									
Type of compressors		-	Scroll	Scroll	Scroll	Scroll	Scroll	Scroll	Scroll
No. of compressors		Nr	4	4	4	4	4	4	4
Rated power (C1)		[HP]	60	70	80	90	100	100	120
Rated power (C2)		[HP]	60	70	80	90	100	120	120
Std Capacity control steps		-	4	6	4	6	6	6	4
Oil charge (C1)		[l]	13	13	13	13	13	13	13
Oil charge (C2)		[l]	13	13	13	13	13	13	13
Refrigerant charge (C1)	1	[kg]	27	34	35	36	45	44	58
Refrigerant charge (C2)	1	[kg]	26	33	33	35	44	53	56
Refrigeration circuits		-	2	2	2	2	2	2	2
<b>Internal exchanger</b>									
Type of internal exchanger	2	-	PHE	PHE	PHE	PHE	PHE	PHE	PHE
Water content		[l]	24	29	32	37	42	49	58
System water content	3	l	1717	1723	2173	1720	2183	2327	3330
<b>External Section Fans</b>									
Type of fans	4	-	AX	AX	AX	AX	AX	AX	AX
Number of fans		Nr	6	6	6	8	8	10	10
Type of motor	5	-	AC/P	AC/P	AC/P	AC/P	AC/P	AC/P	AC/P
Standard airflow		[l/s]	30282	29943	28704	40376	39924	50471	47841
<b>Connections</b>									
Water fittings		-	4"	4"	4"	5"	5"	5"	5"
<b>Power supply</b>									
Standard power supply		V	400/3~/50	400/3~/50	400/3~/50	400/3~/50	400/3~/50	400/3~/50	400/3~/50
<b>Electrical data</b>									
FLA Total		A	262,1	291,1	320,1	379,7	408,7	457,1	497,3
FLI Total		kW	155,8	177,0	198,2	227,5	248,7	275,8	299,2
M.I.C. - Value	6	A	512,5	611,0	640,0	649,4	678,4	726,8	767,0
M.I.C. - with soft start accessory	6	A	374,7	439,0	468,0	649,4	678,4	726,8	767,0

- Indicative values for standard units with possible +/-10% variation. The actual data are indicated on the unit label
- PHE = plate exchanger
- Recommended system water content that does not consider the internal exchanger water content (evaporator). With outdoor air low temperature applications or low medium requested loads, the minimum installation water volume is obtained doubling the indicated value.
- AX = axial fan

- AC/P = asynchronous three-phase external rotor motor with phase cutting speed automatic control  
Unbalance between phase max 2% Voltage variation: max +/- 10%  
Electrical data refer to standard units; according to the installed accessories, the data can suffer some variations.
- M.I.C. = Maximum unit starting current.  
The M.I.C. value is obtained adding the max. compressor starting current of the highest size to the power input at max. admissible conditions (F.L.A.) of the remaining electric components.

### Sound levels

Size	Sound power level (dB)								Sound power level dB(A)	Sound pressure level dB(A)
	Octave band (Hz)									
	63	125	250	500	1000	2000	4000	8000		
120.4	88	85	85	83	83	80	66	57	86	66
140.4	88	85	85	83	83	80	66	57	86	66
160.4	89	86	86	84	84	81	67	58	87	67
180.4	96	92	91	88	84	79	73	67	90	69
200.4	96	92	91	88	84	79	73	67	90	69
220.4	97	93	92	89	85	80	74	68	90	69
240.4	97	93	92	89	85	80	74	68	90	70

The sound levels refer to standard unit with Axitop (no accessories) at full load, in test nominal conditions. The sound pressure level refers to 1 m. from the standard unit outer surface operating in open field. Measures are according to UNI EN ISO 9614-2 regulations, with respect to the EUROVENT 8/1 certification, which provides for a tolerance of 3 dB(A) on the sound power level, which is the only acoustic data to be considered binding.

If unit is set without Axitop, the sound power level presents an increase up to 3 dB(A).

Data referred to the following conditions.

- internal exchanger water = 12/7 °C
- Ambient temperature = 35 °C

The indicated sound levels are only valid within the operating field of the standard unit at full load as indicated in the 'Operating range - cooling' graph in the "Super-silenced EN" configuration. With outdoor air temperatures the unit operates at full load automatically increasing the airflow and taking the same sound levels of the "Soundproofed Compressors SC" configuration.

# Operating range - Cooling

## EXCELLENCE VERSION

### Acoustic configuration: compressor soundproofing (SC)

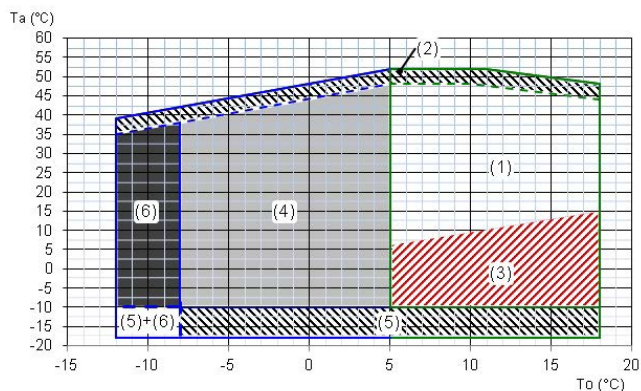

### Acoustic configuration: super-silenced (EN)

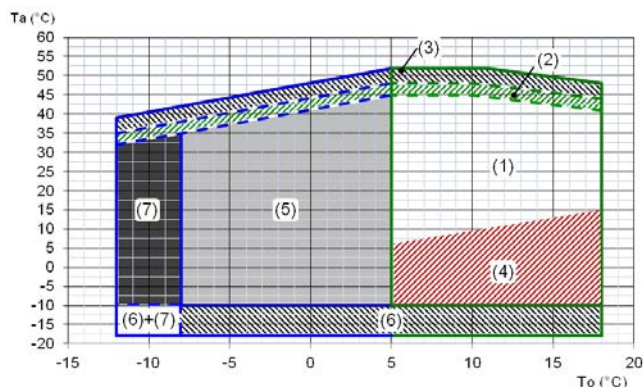

Ta (°C) = external exchanger inlet air temperature (D.B.)  
To (°C) = internal exchanger outlet water temperature

1. Standard unit operating range at full load
2. Unit operating range with automatic staging of the compressor capacity
3. Standard unit operating range with air flow automatic modulation
4. Unit operating range in 'B - Low water temperature' configuration (40% ethylene glycol)
5. Unit operating range with 'REGBT - device for the condensing coil partialization'
6. Extended of operating range (extremely low water temperature option available on request)

Ta (°C) = entering external exchanger air temperature (D.B.)  
To (°C) = leaving internal exchanger water temperature

1. Standard unit operating range at full load
2. Extended operating range with air flow-rate automatic increasing. Inside this field the sound levels are the same of the 'compressor soundproofing (SC)' acoustic configuration
3. Unit operating range with compressor capacity automatic partialization.
4. Standard unit operating range with air flow-rate automatic modulation
5. Operation field extension for unit in 'B - Low water temperature (Brine)' configuration (40% ethylene glycol)
6. Unit operating range with 'REGBT - device for the condensing coil partialization'
7. Extended of operating range (extremely low water temperature option available on request)

## PREMIUM VERSION

### Acoustic configuration: compressor soundproofing (SC)

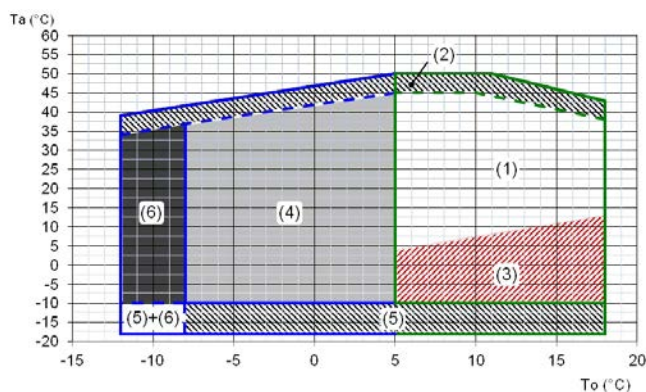

### Acoustic configuration: super-silenced (EN)

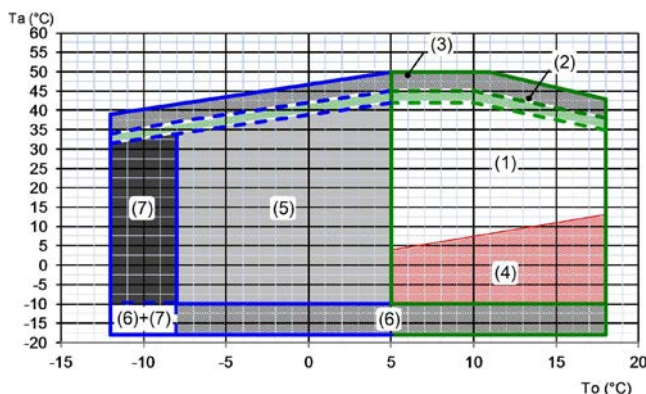

Ta (°C) = external exchanger inlet air temperature (D.B.)  
To (°C) = internal exchanger outlet water temperature

1. Standard unit operating range at full load
2. Unit operating range with automatic staging of the compressor capacity
3. Standard unit operating range with air flow automatic modulation
4. Unit operating range in 'B - Low water temperature' configuration (40% ethylene glycol)
5. Unit operating range with 'REGBT - device for the condensing coil partialization'
6. Extended of operating range (extremely low water temperature option available on request)

Ta (°C) = entering external exchanger air temperature (D.B.)  
To (°C) = leaving internal exchanger water temperature

1. Standard unit operating range at full load
2. Extended operating range with air flow-rate automatic increasing. Inside this field the sound levels are the same of the 'compressor soundproofing (SC)' acoustic configuration
3. Unit operating range with compressor capacity automatic partialization.
4. Standard unit operating range with air flow-rate automatic modulation
5. Operation field extension for unit in 'B - Low water temperature (Brine)' configuration (40% ethylene glycol)
6. Unit operating range with 'REGBT - device for the condensing coil partialization'
7. Extended of operating range (extremely low water temperature option available on request)



## Admissible water flow-rates

Minimum (Qmin) and maximum (Qmax) admissible water flow for the unit to operate correctly.

EXCELLENCE SC / EN		90.4	100.4	110.4	120.4	140.4	160.4	180.4	200.4	220.4	240.4
Qmin	[l/s]	6,7	7,4	8,0	9,3	10,1	11,5	12,8	14,3	15,8	16,4
Qmax	[l/s]	18,3	20,0	21,8	25,1	27,5	31,2	34,5	38,6	42,4	44,0

PREMIUM SC / EN		120.4	140.4	160.4	180.4	200.4	220.4	240.4
Qmin	[l/s]	8,0	9,3	10,1	11,5	12,8	14,3	15,8
Qmax	[l/s]	21,8	25,1	27,5	31,2	34,5	38,6	42,4

## Correction factors for glycol use

% ethylene glycol by weight		5%	10%	15%	20%	25%	30%	35%	40%
Freezing temperature	°C	-2,0	-3,9	-6,5	-8,9	-11,8	-15,6	-19,0	-23,4
Safety temperature	°C	3,0	1,0	-1,0	-4,0	-6,0	-10,0	-14,0	-19,0
Cooling Capacity Factor	Nr	0,997	0,994	0,99	0,986	0,981	0,976	0,970	0,964
Compressor power input Factor	Nr	1,000	1,001	1,001	1,001	1,001	1,002	1,002	1,002
Internal exchanger glycol solution flow factor	Nr	1,003	1,010	1,020	1,033	1,05	1,072	1,095	1,124
Pressure drop Factor	Nr	0,989	0,983	0,979	0,980	0,984	0,993	1,004	1,020

The correction factors shown refer to water and glycol ethylene mixes used to prevent the formation of frost on the exchangers in the water circuit during inactivity in winter.

## Fouling Correction Factors

m2 K / W	Internal exchanger	
	F1	FK1
0.44 x 10 (-4)	1,0	1,0
0.88 x 10 (-4)	0,97	0,99
1.76 x 10 (-4)	0,94	0,98

F1 = Cooling capacity correction factors

FK1 = Compressor power input correction factor

## Overload and control device calibrations

			open	closed	value
High pressure safety pressure switch		[kPa]	4050	3300	-
Antifreeze protection		[°C]	4	5.5	-
High pressure safety valve		[kPa]	-	-	4500
Low pressure safety valve		[kPa]	-	-	2950
Max no. of compressor starts per hour		[n°]	-	-	10
High compressor discharge temperature safety thermostat		[°C]	-	-	140

## Exchanger operating range

	Internal exchanger		
	DPr		DPw
PED (CE)	4500	4500	1000

DPr = Maximum operating pressure on refrigerant side in kPa

DPw = Maximum operating pressure on water side in kPa

# EXCELLENCE VERSION

## Acoustic configuration: compressor soundproofing (SC)



### Cooling performance

(continued)

Size	To (°C)	Entering external exchanger air temperature (°C)											
		25		30		35		40		48		52	
		kWf	kWe	kWf	kWe	kWf	kWe	kWf	kWe	kWf	kWe	kWf	kWe
90.4	5	283	61	269	67	251	74	232	81	208	94	72.8	29
	6	291	62	277	68	258	75	240	82	215	96	75.0	30
	7	301	63	284	68	268	75	249	83	226	97	79.1	30
	10	330	65	314	71	294	77	272	85	248	99	86.7	31
	15	376	68	355	74	332	81	308	88	178	52	-	-
	18	411	71	388	77	362	84	337	91	195	53	-	-
100.4	5	306	67	291	73	273	81	253	89	226	104	146	65
	6	315	68	300	74	281	81	260	89	233	104	150	65
	7	326	69	308	75	291	82	271	90	242	106	156	66
	10	359	71	341	77	319	85	296	93	269	108	173	67
	15	409	75	387	81	362	89	336	97	210	63	-	-
	18	452	78	428	84	399	92	372	100	233	65	-	-
110.4	5	338	75	318	82	298	89	278	98	249	114	147	63
	6	348	75	330	83	308	90	285	99	258	115	152	64
	7	357	76	339	83	318	91	297	100	271	116	159	65
	10	395	79	374	86	349	94	323	103	294	118	173	66
	15	449	83	423	91	394	99	367	107	211	62	-	-
	18	492	87	462	94	431	102	403	111	232	64	-	-
120.4	5	374	84	355	92	333	100	308	110	279	128	147	63
	6	384	85	365	93	342	101	319	111	285	129	150	64
	7	398	86	378	94	354	102	332	113	301	131	158	64
	10	438	89	415	97	388	106	359	115	329	134	173	66
	15	498	94	474	102	439	111	410	121	219	60	-	-
	18	559	98	526	107	490	115	457	125	241	61	-	-
140.4	5	428	95	408	104	383	114	355	124	319	145	187	81
	6	440	96	419	105	393	115	367	126	327	146	191	81
	7	456	98	433	106	407	116	382	127	344	148	201	82
	10	500	101	474	110	445	120	412	130	376	152	220	85
	15	567	107	537	116	503	126	468	137	270	79.7	-	-
	18	635	112	596	121	557	131	520	141	301	82	-	-
160.4	5	482	107	457	116	430	127	402	139	359	160	190	80
	6	497	108	473	118	445	128	412	140	373	162	198	81
	7	514	110	486	119	460	130	429	142	385	163	204	81
	10	564	114	536	124	503	135	466	146	428	168	227	84
	15	639	121	606	131	567	142	528	153	285	76	-	-
	18	706	127	667	136	624	147	583	158	310	77	-	-
180.4	5	543	122	517	134	483	147	449	162	401	190	151	63
	6	564	123	535	135	500	148	460	163	416	192	156	64
	7	577	124	549	136	515	150	476	165	430	194	162	65
	10	638	129	603	141	562	154	519	169	478	199	180	66
	15	721	135	681	148	633	161	591	177	386	122	-	-
	18	795	140	753	153	696	166	649	181	429	124	-	-

kWf = Cooling capacity in kW. The data do not consider the part related to the pumps, required to overcome the pressure drop for the solution circulation inside the exchangers

kWe = Compressor power input in kW

To (°C) = Leaving internal exchanger water temperature (°C) - Performances in function of the inlet/outlet water temperature differential = 5°C

# EXCELLENCE VERSION

## Acoustic configuration: compressor soundproofing (SC)



### Cooling performance

Size	To (°C)	Entering external exchanger air temperature (°C)											
		25		30		35		40		48		52	
		kWf	kWe	kWf	kWe	kWf	kWe	kWf	kWe	kWf	kWe	kWf	kWe
200.4	5	603	133	576	146	540	160	500	175	442	203	271	126
	6	620	135	593	147	555	161	517	176	455	205	279	127
	7	642	137	613	149	574	162	531	178	472	207	289	128
	10	698	142	658	153	617	167	574	183	513	211	314	131
	15	798	150	751	162	706	177	657	191	368	111	-	-
	18	858	156	812	168	760	182	706	197	401	113	-	-
220.4	5	658	148	627	162	590	178	548	196	485	229	273	125
	6	679	150	647	164	605	179	562	197	500	231	281	126
	7	699	152	664	166	624	181	575	199	510	232	287	126
	10	739	155	700	169	661	185	613	204	549	235	309	128
	15	806	161	767	175	723	192	681	212	394	123	-	-
	18	864	166	825	181	773	197	719	218	429	126	-	-
240.4	5	728	162	692	178	647	195	595	215	528	252	276	123
	6	748	164	711	179	663	197	614	217	544	254	284	124
	7	768	165	729	181	678	198	626	218	552	255	288	124
	10	805	168	760	184	710	201	661	223	582	258	304	126
	15	882	175	835	191	787	210	728	229	388	116	-	-
	18	951	181	904	197	840	215	778	234	416	118	-	-

kWf = Cooling capacity in kW. The data do not consider the part related to the pumps, required to overcome the pressure drop for the solution circulation inside the exchangers

kWe = Compressor power input in kW

To (°C) = Leaving internal exchanger water temperature (°C) - Performances in function of the inlet/outlet water temperature differential = 5°C

### Internal exchanger pressure drop

#### Acoustic configuration: compressor soundproofing (SC)

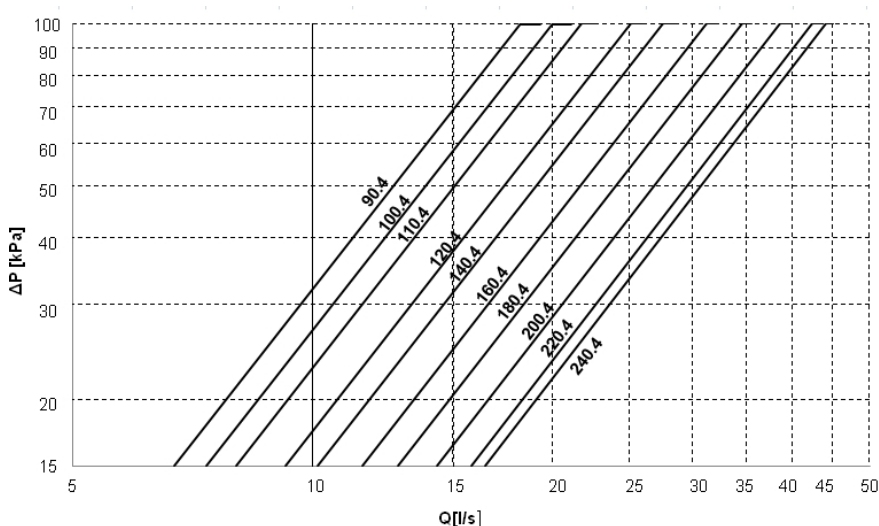

The pressure drops are calculated considering a water temperature of 7°C

Q = water flow-rate [l/s]  
DP = water side pressure drops (kPa)

The water flow-rate must be calculated with the following formula

$$Q [l/s] = kWf / (4,186 \times DT)$$

kWf = Cooling capacity in kW.  
DT = Temperature difference between inlet / outlet water



To the internal exchanger pressure drops must be added the pressure drops of the steel mesh mechanical strainer that must be placed on the water input line. It is a device compulsory for the correct unit operation, and it is available as Clivet option (see the HYDRONIC ASSEMBLY ACCESSORIES). If the mechanical filter is selected and installed by the Customer, it is forbidden the use of filters with the mesh pitch higher than 1,6 mm, because they can cause a bad unit operation and also its serious damaging.

# PREMIUM VERSION

## Acoustic configuration: compressor soundproofing (SC)



### Cooling performance

Size	To (°C)	Entering external exchanger air temperature (°C)											
		25		30		35		40		45		50	
		kWf	kWe	kWf	kWe	kWf	kWe	kWf	kWe	kWf	kWe	kWf	kWe
120.4	5	360	89	339	98	315	107	293	118	278	129	146	64
	6	370	90	348	99	326	108	301	118	287	130	151	64
	7	383	92	359	100	334	109	314	120	301	132	158	65
	10	421	95	394	104	367	113	341	123	329	136	173	67
	15	473	101	443	110	412	119	394	130	219	61	-	-
	18	510	106	480	115	446	124	431	135	-	-	-	-
140.4	5	408	103	386	112	359	122	333	133	314	146	183	81
	6	421	104	396	113	369	124	344	135	327	148	191	82
	7	431	105	406	115	381	125	353	136	337	149	197	83
	10	475	110	445	120	415	130	389	141	377	154	220	86
	15	533	118	503	128	469	138	444	149	270	81.	-	-
	18	578	124	541	133	507	143	485	155	-	-	-	-
160.4	5	451	115	426	125	396	136	369	148	349	161	185	80
	6	467	117	440	127	410	138	379	149	360	162	191	81
	7	479	119	451	128	423	140	394	151	379	165	201	82
	10	526	124	493	134	458	145	428	156	417	171	221	85
	15	592	133	554	143	516	154	488	165	278	77	-	-
	18	638	140	597	150	559	160	538	173	-	-	-	-
180.4	5	531	129	500	142	465	156	434	173	402	190	151	63
	6	545	130	517	144	480	158	444	174	417	192	157	64
	7	564	132	530	145	492	159	459	175	433	193	163	64
	10	620	137	581	149	540	164	502	180	479	197	180	66
	15	696	144	652	157	605	171	572	187	387	121	-	-
	18	757	150	706	163	658	177	621	193	-	-	-	-
200.4	5	571	143	541	156	502	171	464	186	437	205	268	127
	6	590	145	554	158	517	172	479	188	454	206	278	128
	7	610	147	572	160	531	174	495	191	476	212	292	131
	10	662	153	622	166	579	180	539	197	517	217	317	134
	15	747	163	696	176	653	191	614	208	399	123	-	-
	18	797	171	746	183	702	197	674	217	-	-	-	-
220.4	5	641	158	602	174	563	189	519	207	485	228	273	124
	6	663	160	622	175	578	191	534	210	501	231	282	126
	7	679	162	640	177	596	193	551	212	520	233	293	127
	10	743	169	697	184	648	200	600	218	575	242	324	132
	15	835	180	784	195	728	211	684	229	412	127	-	-
	18	900	188	841	202	784	218	743	238	-	-	-	-
240.4	5	697	172	656	188	613	206	564	225	522	248	273	121
	6	719	174	677	190	628	208	582	228	539	251	282	123
	7	736	176	694	192	648	210	604	231	558	254	292	124
	10	806	184	757	200	707	217	649	237	605	259	316	127
	15	907	196	855	213	794	230	738	249	403	116	-	-
	18	981	206	919	221	854	238	801	258	-	-	-	-

kWf = Cooling capacity in kW. The data do not consider the part related to the pumps, required to overcome the pressure drop for the solution circulation inside the exchangers

kWe = Compressor power input in kW

To (°C) = Leaving internal exchanger water temperature (°C) - Performances in function of the inlet/outlet water temperature differential = 5°C

## Internal exchanger pressure drop

### Acoustic configuration: compressor soundproofing (SC)

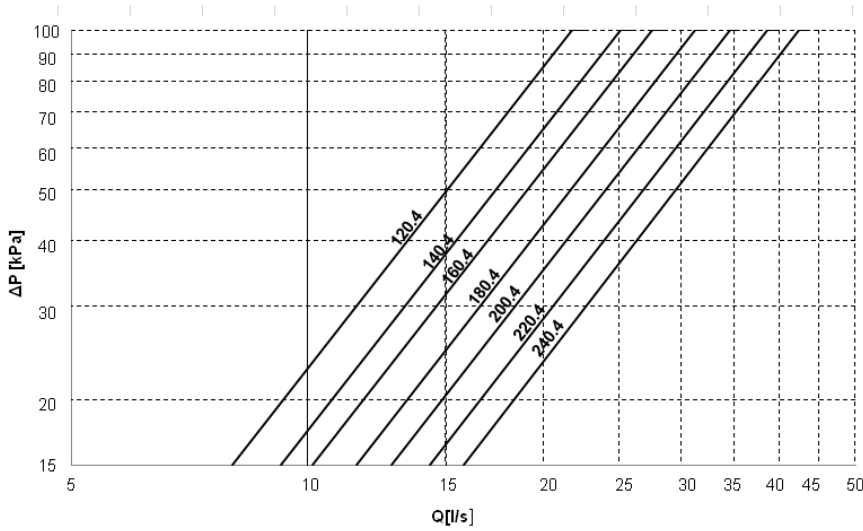

The pressure drops are calculated considering a water temperature of 7°C

Q = water flow-rate[l/s]  
 DP = water side pressure drops (kPa)

The water flow-rate must be calculated with the following formula

$$Q [l/s] = kWf / (4,186 \times DT)$$

kWf = Cooling capacity in kW.  
 DT = Temperature difference between inlet / outlet water



To the internal exchanger pressure drops must be added the pressure drops of the steel mesh mechanical strainer that must be placed on the water input line. It is a device compulsory for the correct unit operation, and it is available as Clivet option (see the HYDRONIC ASSEMBLY ACCESSORIES). If the mechanical filter is selected and installed by the Customer, it is forbidden the use of filters with the mesh pitch higher than 1,6 mm, because they can cause a bad unit operation and also its serious damaging.



# EXCELLENCE VERSION

## Acoustic configuration: super-silenced (EN)

### Cooling performance

(continued)

Size	To (°C)	Entering external exchanger air temperature (°C)											
		25		30		35		40		48		52	
		kWf	kWe	kWf	kWe	kWf	kWe	kWf	kWe	kWf	kWe	kWf	kWe
90.4	5	277	64	261	70	244	76	226	84	208	95	72.7	30
	6	284	64	269	71	252	77	233	85	214	96	74.9	30
	7	294	65	278	71	259	78	240	86	226	97	78.9	30
	10	323	67	304	74	284	81	264	88	248	99	86.6	31
	15	368	71	344	78	321	85	299	92	178	52	-	-
	18	401	74	374	81	348	88	329	95	195	53	-	-
100.4	5	298	69	282	76	264	83	244	91	225	103	145	65
	6	307	70	290	77	273	84	252	92	232	104	150	65
	7	317	71	300	78	280	85	261	93	241	105	156	66
	10	348	74	328	80	308	88	284	96	268	108	173	67
	15	397	78	374	85	348	93	325	101	209	63	-	-
	18	437	82	410	89	385	97	360	105	232	65	-	-
110.4	5	327	78	309	85	288	93	266	101	247	114	146	63
	6	336	79	317	86	297	94	275	103	257	115	151	64
	7	348	80	328	87	307	95	284	104	269	116	158	65
	10	380	83	357	90	332	98	309	107	292	118	172	66
	15	432	88	405	95	377	103	355	112	210	62	-	-
	18	471	91	441	90	415	107	389	116	231	63	-	-
120.4	5	360	88	340	96	320	106	295	115	276	129	145	64
	6	373	89	352	98	328	107	303	117	283	130	149	64
	7	383	90	361	99	341	108	316	118	298	132	157	65
	10	423	94	397	102	369	112	343	122	326	134	172	66
	15	478	100	448	108	417	118	391	128	217	60	-	-
	18	529	104	495	113	462	122	437	133	239	61	-	-
140.4	5	418	99	396	108	371	118	346	129	319	145	186	81
	6	433	100	410	109	383	119	355	130	327	146	191	81
	7	445	101	420	111	393	120	369	132	344	148	201	82
	10	490	106	462	115	431	125	401	136	376	152	220	85
	15	553	112	520	122	486	131	455	143	270	80	-	-
	18	610	117	574	127	537	136	506	148	301	82	-	-
160.4	5	467	112	442	122	414	133	386	145	355	161	188	81
	6	479	114	454	124	428	135	396	146	369	163	195	81
	7	496	115	470	125	438	136	409	148	381	165	202	82
	10	541	120	512	130	478	141	444	153	423	170	224	85
	15	615	129	580	139	541	149	507	161	282	76	-	-
	18	675	134	634	145	593	155	560	167	307	77	-	-
180.4	5	531	130	501	143	465	157	431	173	400	193	151	64
	6	544	131	513	144	479	159	442	174	415	195	156	65
	7	563	133	529	146	491	160	459	176	429	196	161	65
	10	612	138	579	151	537	165	497	181	477	201	179	67
	15	694	146	648	159	602	173	566	189	385	124	-	-
	18	761	152	711	165	661	179	630	195	428	126	-	-

kWf = Cooling capacity in kW. The data do not consider the part related to the pumps, required to overcome the pressure drop for the solution circulation inside the exchangers

kWe = Compressor power input in kW

To (°C) = Leaving internal exchanger water temperature (°C) - Performances in function of the inlet/outlet water temperature differential = 5°C

# EXCELLENCE VERSION

## Acoustic configuration: super-silenced (EN)

### Cooling performance

Size	To (°C)	Entering external exchanger air temperature (°C)											
		25		30		35		40		48		52	
		kWf	kWe	kWf	kWe	kWf	kWe	kWf	kWe	kWf	kWe	kWf	kWe
200.4	5	571	143	541	156	502	171	464	186	437	205	268	127
	6	590	145	554	158	517	172	479	188	454	206	278	128
	7	610	147	572	160	549	170	495	191	476	212	292	131
	10	662	153	622	166	579	180	539	197	517	217	317	134
	15	747	163	696	176	653	191	614	208	399	123	366	142
	18	797	171	746	183	702	197	674	217	433	125	396	147
220.4	5	642	156	607	171	568	188	523	205	484	230	273	125
	6	661	158	624	173	582	189	539	207	498	232	281	126
	7	677	159	642	175	599	191	551	209	509	233	286	127
	10	716	163	672	178	624	194	575	212	547	236	308	128
	15	780	170	736	185	687	202	643	220	393	124	-	-
	18	863	176	812	191	762	209	711	226	441	126	-	-
240.4	5	700	171	660	188	615	207	565	227	527	254	275	124
	6	718	173	676	190	630	209	580	229	542	255	283	125
	7	736	175	695	192	642	210	591	230	550	256	287	125
	10	773	178	723	195	670	214	616	233	580	260	303	127
	15	841	186	790	203	738	222	692	243	387	117	-	-
	18	941	193	881	210	817	228	773	248	431	118	-	-

kWf = Cooling capacity in kW. The data do not consider the part related to the pumps, required to overcome the pressure drop for the solution circulation inside the exchangers

kWe = Compressor power input in kW

To (°C) = Leaving internal exchanger water temperature (°C) - Performances in function of the inlet/outlet water temperature differential = 5°C

### Internal exchanger pressure drop

#### Acoustic configuration: super-silenced (EN)

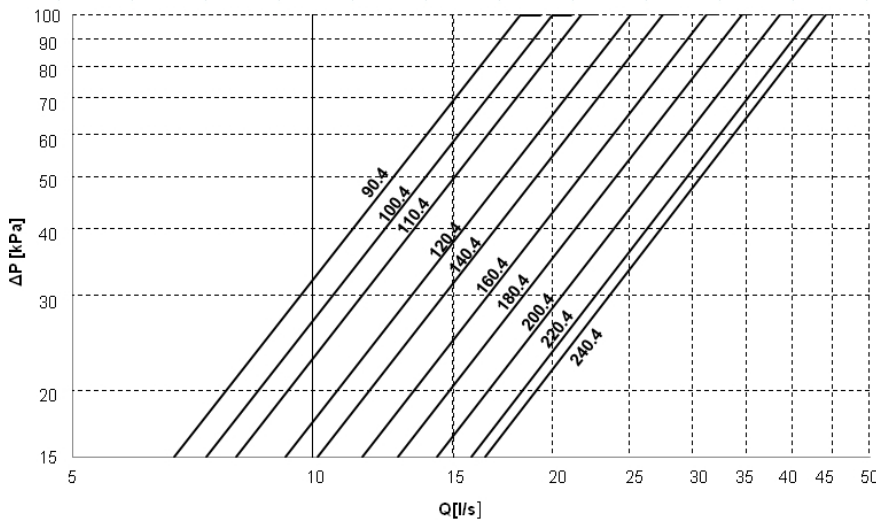

The pressure drops are calculated considering a water temperature of 7°C

Q = water flow-rate [l/s]  
 DP = water side pressure drops (kPa)

The water flow-rate must be calculated with the following formula

$$Q [l/s] = kWf / (4,186 \times DT)$$

kWf = Cooling capacity in kW.  
 DT = Temperature difference between inlet / outlet water



To the internal exchanger pressure drops must be added the pressure drops of the steel mesh mechanical strainer that must be placed on the water input line. It is a device compulsory for the correct unit operation, and it is available as Clivet option (see the HYDRONIC ASSEMBLY ACCESSORIES). If the mechanical filter is selected and installed by the Customer, it is forbidden the use of filters with the mesh pitch higher than 1,6 mm, because they can cause a bad unit operation and also its serious damaging.

# PREMIUM VERSION

## Acoustic configuration: super-silenced (EN)

### Cooling performance

Size	To (°C)	Entering external exchanger air temperature (°C)											
		25		30		35		40		45		50	
		kWf	kWe	kWf	kWe	kWf	kWe	kWf	kWe	kWf	kWe	kWf	kWe
120.4	5	350	93	328	102	304	111	283	122	277	129	146	63
	6	359	94	337	103	312	113	293	123	286	130	151	64
	7	371	96	347	104	322	114	304	125	300	132	158	65
	10	404	100	377	109	352	118	335	129	329	135	173	66
	15	455	106	425	115	398	125	378	135	219	61	-	-
	18	488	111	456	120	434	130	404	139	-	-	-	-
140.4	5	396	107	372	117	345	127	325	138	315	144	184	81
	6	406	109	384	118	356	128	334	140	328	146	191	82
	7	419	110	392	120	365	130	343	141	338	148	198	82
	10	459	116	429	125	400	136	379	147	378	153	221	85
	15	512	124	479	133	451	143	432	155	271	80	-	-
	18	553	130	518	140	490	150	464	160	-	-	-	-
160.4	5	434	120	406	131	378	141	356	154	352	160	186	80
	6	448	122	420	133	390	143	365	155	363	162	192	81
	7	459	124	429	134	405	146	381	158	382	164	202	82
	10	502	130	469	141	437	152	415	163	420	170	223	85
	15	560	140	524	150	494	160	468	175	280	76	-	-
	18	606	147	567	157	537	168	500	181	-	-	-	-
180.4	5	516	135	482	148	445	163	413	179	399	190	150	63
	6	528	137	494	150	457	164	427	181	413	192	156	64
	7	545	138	510	152	471	166	441	182	429	193	161	64
	10	592	143	554	157	513	171	482	187	475	197	178	66
	15	666	152	619	166	582	180	555	196	383	121	-	-
	18	714	158	665	171	628	185	600	205	-	-	-	-
200.4	5	545	153	511	166	474	180	442	197	430	208	264	128
	6	563	155	528	168	489	183	456	199	448	209	274	129
	7	577	157	538	170	504	185	477	203	469	214	287	132
	10	627	164	587	177	546	192	516	210	510	220	312	136
	15	701	175	653	188	617	203	580	223	393	124	-	-
	18	747	183	703	196	665	212	619	228	-	-	-	-
220.4	5	619	165	579	180	536	197	498	216	481	228	271	124
	6	636	167	595	182	553	199	514	218	497	230	280	125
	7	658	170	615	185	573	202	530	220	516	232	291	127
	10	712	177	663	192	616	209	578	228	571	241	321	131
	15	795	189	743	204	694	220	651	239	409	126	-	-
	18	854	198	798	212	749	229	695	245	-	-	-	-
240.4	5	665	181	625	198	579	215	536	236	515	248	269	121
	6	681	184	644	200	597	218	551	239	532	251	278	123
	7	700	186	660	203	614	221	568	242	551	254	288	124
	10	766	194	713	211	661	229	617	251	597	259	312	127
	15	856	208	798	224	745	242	695	267	398	116	-	-
	18	922	218	860	234	803	251	742	276	-	-	-	-

kWf = Cooling capacity in kW. The data do not consider the part related to the pumps, required to overcome the pressure drop for the solution circulation inside the exchangers

kWe = Compressor power input in kW

To (°C) = Leaving internal exchanger water temperature (°C) - Performances in function of the inlet/outlet water temperature differential = 5°C

## Internal exchanger pressure drop

Acoustic configuration: super-silenced (EN)

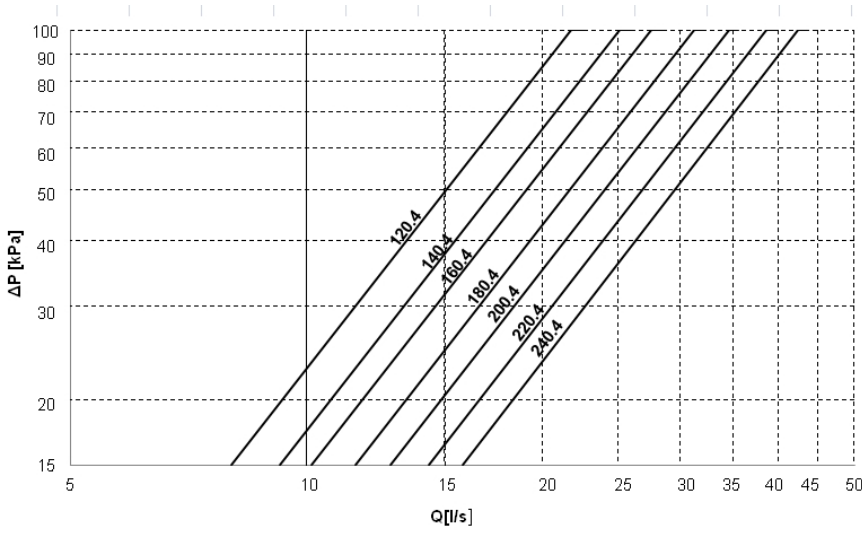

The pressure drops are calculated considering a water temperature of 7°C

Q = water flow-rate[l/s]  
 DP = water side pressure drops (kPa)

The water flow-rate must be calculated with the following formula

$$Q [l/s] = kWf / (4,186 \times DT)$$

kWf = Cooling capacity in kW.  
 DT = Temperature difference between inlet / outlet water



To the internal exchanger pressure drops must be added the pressure drops of the steel mesh mechanical strainer that must be placed on the water input line. It is a device compulsory for the correct unit operation, and it is available as Clivet option (see the HYDRONIC ASSEMBLY ACCESSORIES). If the mechanical filter is selected and installed by the Customer, it is forbidden the use of filters with the mesh pitch higher than 1,6 mm, because they can cause a bad unit operation and also its serious damaging.

# EXCELLENCE VERSION

## Acoustic configuration: compressor soundproofing (SC)



### Cooling performance at part load

Size	Load	Entering external exchanger air temperature (°C)											
		35°C			30°C			25°C			20°C		
		kWf	kWe_tot	EER	kWf	kWe_tot	EER	kWf	kWe_tot	EER	kWf	kWe_tot	EER
90.4	100%	268	85	3,16	284	77	3,67	301	72	4,19	319	63	5,08
	75%	201	53	3,79	213	49	4,34	226	46	4,89	239	44	5,40
	50%	134	36	3,68	142	34	4,21	151	32	4,78	159	30	5,37
	25%	67	19	3,60	71	17	4,13	75	16	4,68	80	15	5,35
	Minimum	54	15	3,61	57	14	4,12	59	13	4,67	61	11	5,35
100.4	100%	291	92	3,17	308	84	3,68	326	78	4,20	342	70	4,91
	75%	218	59	3,69	231	55	4,24	245	52	4,75	257	49	5,27
	50%	145	39	3,76	154	36	4,27	163	34	4,74	171	33	5,26
	25%	73	19	3,77	77	18	4,25	82	17	4,72	86	16	5,22
	Minimum	68	18	3,76	71	17	4,25	74	16	4,71	78	15	5,23
110.4	100%	318	101	3,15	339	92	3,67	357	85	4,19	382	76	5,02
	75%	238	64	3,72	254	60	4,25	268	56	4,80	287	54	5,33
	50%	159	41	3,92	169	38	4,42	179	36	4,97	191	35	5,47
	25%	-	-	-	-	-	-	-	-	-	-	-	-
	Minimum	84	22	3,91	89	20	4,43	92	19	4,96	96	17	5,48
120.4	100%	354	112	3,16	378	103	3,67	398	95	4,19	426	84	5,09
	75%	265	72	3,69	284	67	4,25	299	62	4,79	319	60	5,31
	50%	177	45	3,98	189	42	4,53	199	39	5,08	213	38	5,65
	25%	-	-	-	-	-	-	-	-	-	-	-	-
	Minimum	106	27	3,98	112	25	4,53	117	23	5,08	121	22	5,64
140.4	100%	407	129	3,16	433	119	3,64	456	110	4,15	482	98	4,90
	75%	305	84	3,63	325	79	4,11	342	74	4,62	362	71	5,11
	50%	203	53	3,82	216	50	4,33	228	47	4,85	241	45	5,34
	25%	-	-	-	-	-	-	-	-	-	-	-	-
	Minimum	108	28	3,85	114	26	4,37	119	24	4,88	115	23	5,04
160.4	100%	460	144	3,19	486	132	3,68	514	122	4,21	545	108	5,05
	75%	345	92	3,74	365	86	4,24	385	82	4,72	409	78	5,23
	50%	230	58	3,95	243	55	4,45	257	52	4,95	273	51	5,40
	25%	-	-	-	-	-	-	-	-	-	-	-	-
	Minimum	137	35	3,95	144	32	4,45	149	30	4,95	144	28	5,05
180.4	100%	515	164	3,14	549	149	3,68	577	137	4,21	612	121	5,06
	75%	387	99	3,89	412	93	4,43	433	87	4,98	459	83	5,53
	50%	258	65	3,96	274	61	4,48	289	57	5,03	306	55	5,57
	25%	129	32	3,99	137	30	4,51	144	29	5,03	153	28	5,54
	Minimum	111	28	3,98	117	26	4,52	122	24	5,04	126	23	5,56
200.4	100%	574	179	3,21	613	164	3,74	642	153	4,20	677	134	5,05
	75%	431	112	3,85	460	106	4,34	481	98	4,89	508	94	5,39
	50%	287	74	3,90	306	70	4,38	321	66	4,89	339	63	5,38
	25%	144	37	3,91	153	35	4,37	160	33	4,83	169	32	5,30
	Minimum	139	36	3,90	146	33	4,37	151	31	4,84	157	30	5,31
220.4	100%	624	197	3,17	664	182	3,65	699	168	4,16	739	148	4,99
	75%	468	136	3,44	498	125	3,98	524	118	4,44	554	111	4,99
	50%	312	81	3,83	332	76	4,35	350	72	4,87	369	69	5,37
	25%	-	-	-	-	-	-	-	-	-	-	-	-
	Minimum	199	52	3,83	209	48	4,35	217	45	4,87	225	42	5,38
240.4	100%	678	215	3,15	729	197	3,70	768	181	4,24	812	162	5,01
	75%	508	187	2,72	547	173	3,16	576	160	3,60	609	147	4,14
	50%	339	98,2	3,45	364	90,5	4,02	384	83,7	4,59	406	78,3	5,19
	25%	-	-	-	-	-	-	-	-	-	-	-	-
	Minimum	181	52,5	3,45	194	48,2	4,02	204	44,6	4,57	213	41,1	5,18

kWf = Cooling capacity in kW      kWe\_tot = Unit total power input in kW  
 Load = % of cooling capacity compared to the value at full load  
 Internal exchanger water = output temperature °C / input \* (variable) / constant flow equal to the nominal value.



# PREMIUM VERSION



## Acoustic configuration: compressor soundproofing (SC)

### Cooling performance at part load

Size	Load	Entering external exchanger air temperature (°C)											
		35°C			30°C			25°C			20°C		
		kWf	kWe_tot	EER	kWf	kWe_tot	EER	kWf	kWe_tot	EER	kWf	kWe_tot	EER
120.4	100%	334	118	2,83	359	109	3,29	383	100	3,83	421	85	4,94
	75%	251	68	3,71	270	63	4,27	287	60	4,78	315	67	4,73
	50%	167	42	3,99	180	40	4,56	191	37	5,12	210	37	5,71
	25%	-	-	-	-	-	-	-	-	-	-	-	-
	Minimum	105	26	3,99	110	24	4,55	116	23	5,13	120	21	5,71
140.4	100%	381	135	2,82	406	124	3,27	431	115	3,75	463	102	4,54
	75%	286	78	3,65	305	74	4,13	324	70	4,62	347	68	5,09
	50%	190	49	3,92	203	46	4,40	216	44	4,88	232	43	5,37
	25%	-	-	-	-	-	-	-	-	-	-	-	-
	Minimum	98	25	3,92	102	23	4,40	106	22	4,87	110	21	5,36
160.4	100%	423	149	2,84	451	138	3,27	479	128	3,74	526	108	4,87
	75%	317	84	3,76	339	79	4,29	359	76	4,75	395	84	4,71
	50%	212	52	4,08	226	49	4,62	240	46	5,17	263	46	5,75
	25%	-	-	-	-	-	-	-	-	-	-	-	-
	Minimum	133	33	4,08	139	30	4,61	145	28	5,16	150	26	5,76
180.4	100%	492	171	2,88	530	157	3,38	564	144	3,92	605	128	4,73
	75%	369	100	3,69	398	94	4,24	423	88	4,79	454	86	5,29
	50%	246	62	3,97	265	59	4,51	282	56	5,03	303	55	5,54
	25%	-	-	-	-	-	-	-	-	-	-	-	-
	Minimum	127	32	3,97	133	30	4,51	139	28	5,03	144	26	5,53
200.4	100%	531	186	2,85	572	172	3,33	610	159	3,84	654	141	4,64
	75%	398	108	3,69	429	102	4,21	457	97	4,72	491	94	5,21
	50%	265	67	3,97	286	64	4,50	305	61	5,01	327	59	5,51
	25%	-	-	-	-	-	-	-	-	-	-	-	-
	Minimum	137	34	3,98	144	32	4,50	150	30	5,01	156	28	5,52
220.4	100%	596	208	2,87	640	192	3,33	679	177	3,84	729	157	4,64
	75%	447	122	3,66	480	115	4,17	509	109	4,67	547	106	5,16
	50%	298	76	3,93	320	72	4,43	340	69	4,91	365	68	5,41
	25%	-	-	-	-	-	-	-	-	-	-	-	-
	Minimum	153	39	3,93	161	36	4,43	167	34	4,91	173	32	5,40
240.4	100%	648	226	2,87	694	208	3,34	736	192	3,83	809	162	4,99
	75%	486	128	3,80	521	120	4,34	552	114	4,84	607	127	4,78
	50%	324	79	4,09	347	75	4,65	368	70	5,23	404	69	5,82
	25%	-	-	-	-	-	-	-	-	-	-	-	-
	Minimum	203	50	4,09	213	46	4,65	222	43	5,23	230	40	5,83

kWf = Cooling capacity in kW

kWe\_tot = Unit total power input in kW

Load = % of cooling capacity compared to the value at full load

Internal exchanger water = output temperature 7°C / input \* (variable) / constant flow equal to the nominal value.

# EXCELLENCE VERSION

## Acoustic configuration: super-silenced (EN)

### Cooling performance at part load

Size	Load	Entering external exchanger air temperature (°C)											
		35°C			30°C			25°C			20°C		
		kWf	kWe_tot	EER	kWf	kWe_tot	EER	kWf	kWe_tot	EER	kWf	kWe_tot	EER
90.4	100%	259	85	3,04	278	78	3,57	294	72	4,09	317	62	5,10
	75%	194	51	3,84	209	48	4,37	221	44	4,99	238	43	5,48
	50%	129	33	3,94	139	31	4,48	147	29	5,02	159	29	5,58
	25%	65	16	3,97	70	16	4,49	74	15	5,00	79	14	5,51
	Minimum	64	16	3,96	67	15	4,50	70	14		73	13	
100.4	100%	280	92	3,04	300	84	3,56	317	78	4,09	342	67	5,10
	75%	210	55	3,85	225	52	4,37	238	48	4,99	257	47	5,49
	50%	140	35	3,99	150	33	4,52	159	31	5,08	171	31	5,61
	25%	70	18	4,00	75	17	4,52	79	16	5,05	86	15	5,56
	Minimum	69	17	3,99	73	16	4,52	76	15		79	14	
110.4	100%	307	102	3,01	328	93	3,52	348	86	4,05	375	74	5,05
	75%	230	60	3,83	246	57	4,34	261	53	4,97	281	52	5,46
	50%	154	38	4,01	164	36	4,52	174	34	5,09	188	33	5,65
	25%	77	19	4,00	82	18	4,52	87	17	5,09	94	17	5,62
	Minimum	76	19	4,00	79	18	4,52	83	16		86	15	
120.4	100%	341	115	2,97	361	105	3,44	383	97	3,96	410	85	4,82
	75%	256	69	3,72	271	67	4,08	287	63	4,59	307	60	5,13
	50%	170	42	4,07	181	40	4,50	192	38	5,07	205	36	5,65
	25%	-	-	-	-	-	-	-	-	-	-	-	-
	Minimum	105	26	4,08	106	24	4,49	110	22		114	20	
140.4	100%	393	130	3,02	420	119	3,53	445	110	4,05	480	95	5,05
	75%	295	77	3,85	315	73	4,33	333	68	4,93	360	66	5,44
	50%	196	49	3,98	210	47	4,50	222	44	5,03	240	43	5,58
	25%	98	25	3,99	105	23	4,51	111	22	5,02	120	22	5,56
	Minimum	97	24	4,00	102	23	4,50	106	21		110	20	
160.4	100%	438	146	3,00	470	134	3,51	496	124	4,00	530	109	4,86
	75%	329	90	3,66	352	85	4,13	372	81	4,62	397	77	5,14
	50%	219	54	4,03	235	52	4,55	248	49	5,06	265	47	5,64
	25%	-	-	-	-	-	-	-	-	-	-	-	-
	Minimum	132	33	4,04	138	30	4,54	143	28		147	26	
180.4	100%	491	169	2,91	529	155	3,41	563	142	3,96	607	122	4,98
	75%	368	99	3,71	396	94	4,23	422	86	4,91	456	84	5,41
	50%	245	63	3,90	264	59	4,46	281	55	5,07	304	54	5,65
	25%	123	31	3,93	132	30	4,47	141	28	5,09	152	27	5,63
	Minimum	121	31	3,91	128	29	4,48	134	26		139	25	
200.4	100%	549	182	3,02	572	172	3,33	610	159	3,84	658	137	4,80
	75%	412	108	3,81	429	105	4,09	457	97	4,71	493	95	5,18
	50%	274	69	3,97	286	67	4,28	305	63	4,83	329	61	5,36
	25%	137	35	3,97	143	33	4,28	152	32	4,81	164	31	5,31
	Minimum	135	34	3,98	138	32	4,28	145	30		151	28	
220.4	100%	599	203	2,95	642	186	3,45	677	171	3,96	731	147	4,97
	75%	449	119	3,77	482	112	4,30	508	104	4,88	548	102	5,37
	50%	299	75	3,97	321	71	4,51	339	67	5,07	365	65	5,62
	25%	-	-	-	-	-	-	-	-	-	-	-	-
	Minimum	177	45	3,97	186	41	4,52	194	38		201	36	
240.4	100%	642	221	2,90	695	203	3,42	736	186	3,96	787	164	4,80
	75%	481	136	3,54	521	128	4,07	552	120	4,60	590	115	5,13
	50%	321	82	3,94	347	77	4,51	368	72	5,10	393	69	5,69
	25%	-	-	-	-	-	-	-	-	-	-	-	-
	Minimum	193	49	3,94	204	45	4,52	212	42		219	38	

kWf = Cooling capacity in kW

kWe\_tot = Unit total power input in kW

Load = % of cooling capacity compared to the value at full load

Internal exchanger water = output temperature °C / input \* (variable) / constant flow equal to the nominal value.

# PREMIUM VERSION

## Acoustic configuration: super-silenced (EN)

### Cooling performance at part load

Size	Load	Entering external exchanger air temperature (°C)											
		35°C			30°C			25°C			20°C		
		kWf	kWe_tot	EER	kWf	kWe_tot	EER	kWf	kWe_tot	EER	kWf	kWe_tot	EER
120.4	100%	322	121	2,66	347	111	3,13	371	102	3,64	414	86	4,81
	75%	241	66	3,67	260	62	4,21	279	58	4,79	311	59	5,24
	50%	161	40	4,01	174	38	4,63	186	35	5,25	207	35	5,86
	25%	-	-	-	-	-	-	-	-	-	-	-	-
	Minimum	103	26	4,02	109	24	4,62	114	22	5,24	118	20	5,86
140.4	100%	365	137	2,66	392	126	3,11	419	117	3,58	461	102	4,52
	75%	274	71	3,87	294	66	4,46	314	63	4,97	346	64	5,41
	50%	182	45	4,04	196	43	4,60	210	41	5,10	230	41	5,60
	25%	-	-	-	-	-	-	-	-	-	-	-	-
	Minimum	99	24	4,05	105	23	4,61	109	21	5,09	113	20	5,61
160.4	100%	405	153	2,65	429	141	3,04	459	131	3,50	512	110	4,65
	75%	304	83	3,68	322	78	4,13	344	74	4,67	384	75	5,11
	50%	202	50	4,04	215	47	4,57	229	44	5,16	256	44	5,79
	25%	-	-	-	-	-	-	-	-	-	-	-	-
	Minimum	129	32	4,05	134	29	4,57	141	27	5,17	146	25	5,79
180.4	100%	471	175	2,69	510	160	3,19	545	147	3,71	599	128	4,68
	75%	353	91	3,88	382	84	4,55	409	80	5,11	450	81	5,56
	50%	236	58	4,07	255	55	4,68	273	52	5,21	300	52	5,73
	25%	-	-	-	-	-	-	-	-	-	-	-	-
	Minimum	128	31	4,06	136	29	4,68	142	27	5,20	147	26	5,72
200.4	100%	504	194	2,60	538	179	3,01	577	165	3,50	635	144	4,41
	75%	378	100	3,78	403	93	4,34	433	89	4,88	476	90	5,29
	50%	252	63	3,98	269	60	4,51	289	58	5,02	317	58	5,51
	25%	-	-	-	-	-	-	-	-	-	-	-	-
	Minimum	137	34	3,98	144	32	4,50	150	30	5,01	156	28	5,52
220.4	100%	573	213	2,69	615	196	3,14	658	181	3,64	723	157	4,61
	75%	430	111	3,87	461	103	4,48	493	98	5,01	542	100	5,44
	50%	287	71	4,04	307	67	4,58	329	65	5,10	362	64	5,62
	25%	143	37	3,88	154	35	4,41	164	34	4,87	181	34	5,39
	Minimum	124	32	3,84	132	30	4,35	137	28	4,80	142	27	5,25
240.4	100%	614	233	2,64	660	214	3,08	700	197	3,55	780	165	4,73
	75%	460	126	3,65	495	119	4,16	525	112	4,69	585	114	5,13
	50%	307	77	4,01	330	72	4,60	350	68	5,19	390	67	5,79
	25%	-	-	-	-	-	-	-	-	-	-	-	-
	Minimum	196	49	4,01	206	45	4,60	215	41	5,18	223	38	5,80

kWf = Cooling capacity in kW

kWe\_tot = Unit total power input in kW

Load = % of cooling capacity compared to the value at full load

Internal exchanger water = output temperature 7°C/ input \* (variable) / constant flow equal to the nominal value.

# Configurations

Consult the "Option compatibility" section.

## B - Low water temperature (Brine)

Configuration also known as "Brine". Enables an "unfreezable" solution to be cooled (for example, water and ethylene glycol in suitable quantities) up to a temperature of between +4°C and -8°C. It includes:

- suitable exchangers with extra-thick closed-cell insulation
- electronic expansion valve, functional calibration and safety devices suitable for particular uses.

- ⚠ During the selection phase it is necessary to indicate the required operating type, the unit will be optimised on the basis of this: - Unit with single operating set-point (only at low temperature) - Unit with double operating set-point
- ⚠ The unit in this configuration has a different operation range, indicated in the operating range section.
- ⚠ In low temperature operation, some staging steps could not be available.
- ⚠ The glycol concentration must be chosen based on the minimum temperature the water can reach. The presence of glycol influences pressure drops on the water side and the unit's output as indicated in the table reporting the "correction factors for use with glycol".
- ⚠ The "Extremely low water temperature" option for the chilled water production down to -12°C is available on request.

## D - Partial energy recovery

A configuration which enables the production of hot water free-of-charge while operating in the cooling mode, thanks to the partial recovery of condensation heat that would otherwise be disposed of into the external heat source.

This option is also known as "desuperheater". It is made up of a Inox 316 stainless steel brazed plate heat exchangers, suitable for recovering a part of the capacity dispersed by the unit (the dispersed heating capacity is equal to the sum of the cooling capacity and the electrical input capacity of the compressors).

The partial recovery device is considered to be operating when it is powered by the water flow which is to be heated. This condition improves the unit performance, since it reduces the condensation temperature: in nominal conditions the cooling capacity increases indicatively by 3.2% and the power input of the compressors is reduced by 3.6%.

When the temperature of the water to be heated is particularly low, it is opportune to insert a flow regulation valve in the hydraulic circuit, to maintain the recovery output temperature at higher than 35°C and thus avoid refrigerant condensation in the partial energy recovery device.

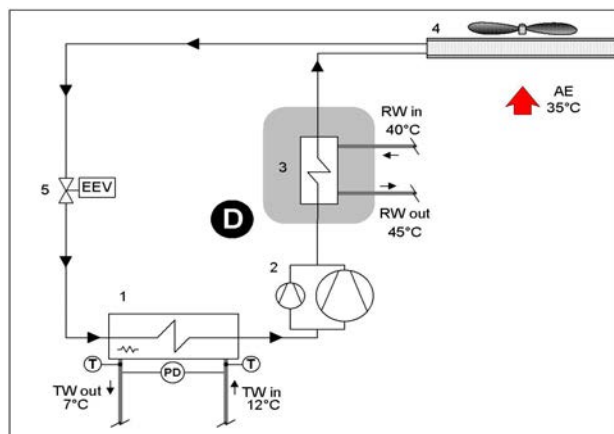

D - Partial recovery device

- 1 - Internal exchanger
- 2 - Compressors
- 3 - Recovery exchanger
- 4 - External exchanger
- 5 - Expansion electronic valve

- TW in chilled water inlet
- TW out chilled water outlet
- RW in - Recovery water input
- RW out - Recovery water output
- T - Temperature probe
- PD - Differential pressure switch
- AE Outdoor air

- ⚠ The power delivered by the partial recovery is 20% of the thermal power dissipation (cooling + electrical power absorbed by the compressors)

### Pressure drops of partial energy recovery exchanger

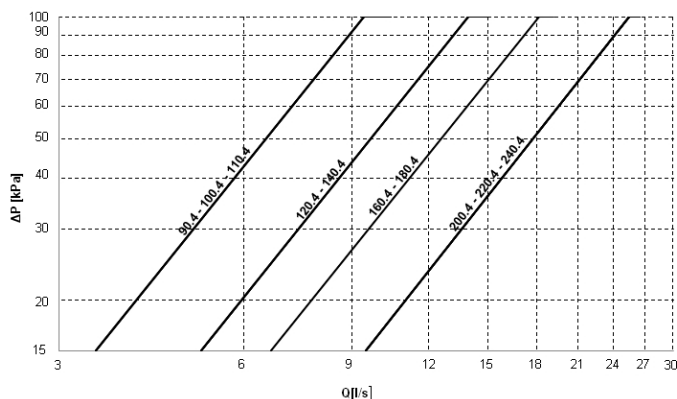

Q = water flow-rate[l/s]  
DP = water side pressure drops (kPa)

### Partial recovery heating capacity

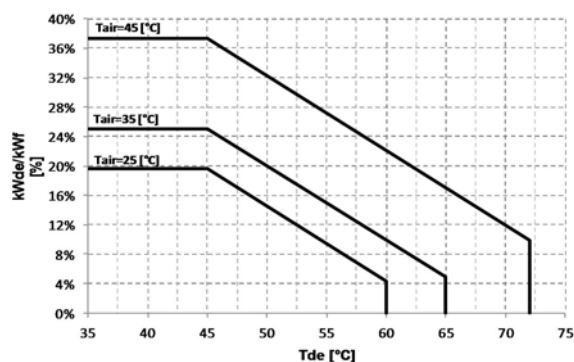

kWde/kWf = Heat recovered/Cooling capacity [%]  
Tde = Heat recovering device outlet water temperature [°C]

- ⚠ Values with a tolerance of ± 2%

**Example:** Requested cooling capacity: 515 kW with chilled water at 12/7°C and 35°C outdoor air.  
Size purpose of the study: WSAT-XSC3 EXC SC 180.4  
Hot water required temperature: +45°C  
Recovery capacity: 25% di 515 kW = 129 kW  
Design flow-rate: 6,2 l/s  
Recovery pressure drop: 23 kPa

## R - Total energy recovery

A configuration which enables the production of hot water free-of-charge while operating in the cooling mode, thanks to the total recovery of condensation heat that would otherwise be disposed of into the external heat source. This solution increases the overall efficiency of the system in all cases where a high-level of hot water production is required. It is made up of a brazed plate heat exchanger made of 316 stainless steel, suitable for recovering all the unit heat capacity (equal to the sum of the cooling capacity and the electrical input capacity of the compressors), from the on-off type solenoid valve, from the supply and return temperature sensors in the hot water circuit and the related two-step integrated control logic.

Hot water availability is always subordinate to the production of chilled water.

See the following example:

1. cooling capacity request = 100% / Heating capacity request = 0% >Production only of cooling capacity;
2. cooling capacity request = 100% / Heating capacity request = 0% >Production of cooling and heating capacity by recovery;
3. cooling capacity request = 50% / Heating capacity request = 100% >Production of cooling and heating capacity by recovery, equal to the 50% of the requested heating capacity.



To prevent constant switching in the unit's refrigeration circuit, it is necessary to install a storage tank with an adequate capacity in the system's hot water circuit.



In the absence of hot water circulation in the recovery exchanger, the maximum inlet air temperature is reduced by approximately 2°C compared with the unit without "Total Energy Recovery" mode.

### TOTAL OPERATING ENERGY RECOVERY

When hot water is requested, the condensing coil is deactivated. Condensation takes place wholly within the recovery circuit.

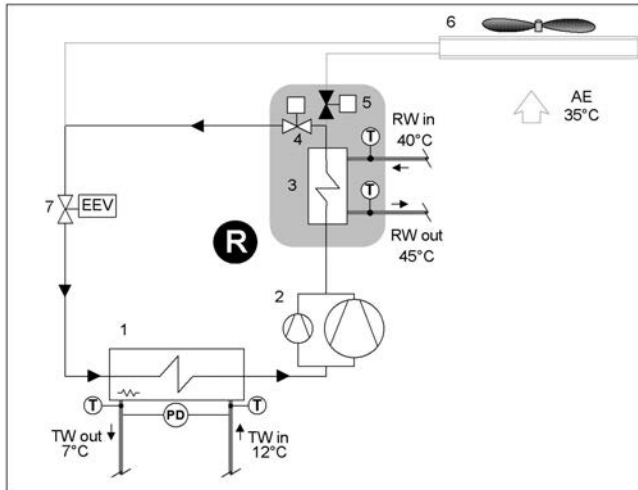

### TOTAL NON-OPERATING ENERGY RECOVERY

When the recovery set-point has been satisfied, the condensing coil is reactivated. In this condition, the total recovery circuit operates as a Partial recovery circuit (Desuperheater).

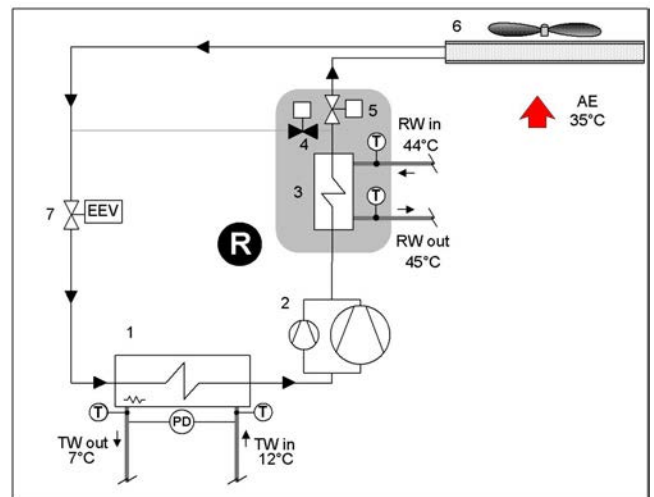

- R - Total recovery device
- 1 - Internal exchanger
- 2 - Compressors
- 3 - Recovery exchanger
- 4 - Total recovery enabling valve

- 5 - External exchanger enabling valve
- 6 - External exchanger
- 7 - Expansion electronic valve
- T - Temperature probe
- PD - Differential pressure switch

- TW in - Chilled water inlet
- TW out - Chilled water outlet
- RW in - Recovery water input
- RW out - Recovery water output
- AE Outdoor air

### Pressure drops of the total energy recovery exchanger

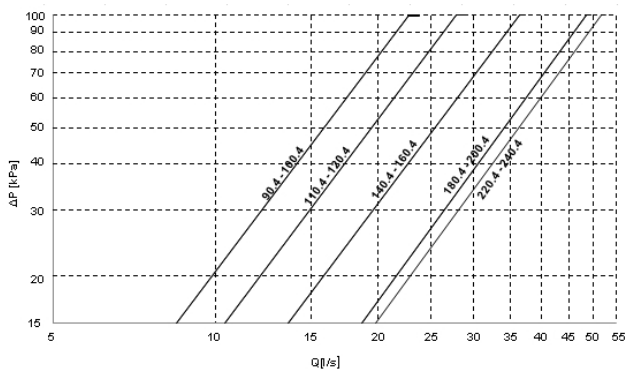

Q = water flow-rate[l/s]  
DP = water side pressure drops (kPa)

### Operating range with recovery

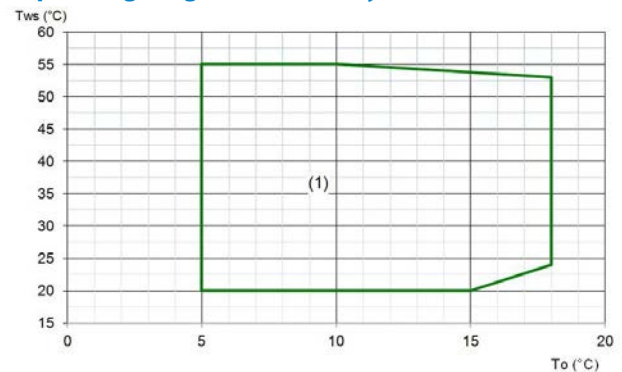

To = leaving internal exchanger water temperature (evaporator)  
Tws = leaving recovery exchanger water temperature

1. Standard unit operating range at full load



## Efficient use of energy with heat recovery

In almost all systems fitted with a chiller used to produce chilled water there is also the need to have hot water. The recovery of condensation heat is an efficient way of producing hot water while the chiller is in operation. It has the double benefit of both reducing the heat load to the condenser, thereby eliminating dissipation costs and generating free hot water, thereby reducing the costs of the auxiliary heater.

### Application versatility of recovery devices

The hot water produced by heat recovery can be used in a number of ways: to reheat air in handling units, to preheat hot water for domestic use or industrial processes, to heat up water in swimming pools, showers and spas, to preheat hot water for laundries or industrial kitchens.



Post-heating in air handling units to control humidity levels in hospitals and labs



Preheating of hot water for domestic use or for industrial process



Heating of water in swimming pools, showers and SPAS



Preheating of hot water for laundries and industrial kitchens

### Air heating

The heat recovery device can be used to cover the entire heat load required. The hot water supply temperature is controlled via a modulating control valve that needs to be fitted on the system at the outlet of the recovery unit. The auxiliary heating device is recommended to cover the thermal energy demand when the chiller is not in operation or is operating at part load.

Example of how heat recovery is used to cover the entire heat demand and control the operating temperature

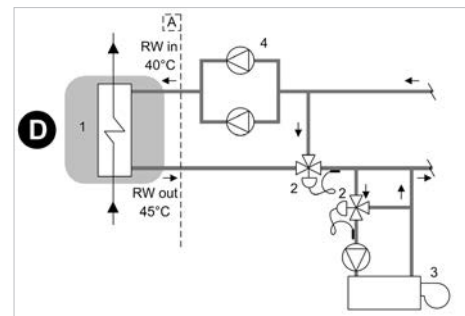

### Water preheating

The heat recovery device can be used to preheat water at the inlet of the main heating device (e.g. boiler). In this case, the demand for hot water is greater than the amount of heat recovered by condensation and the recovery device only covers part of the required heat load. By preheating the water, heating consumption levels are therefore reduced and the main heating device has a lower installed power requirement.

Example of how heat recovery is used to preheat hot water in the system

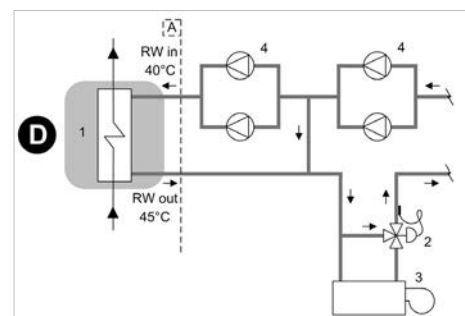

### Domestic hot water production

The heat recovery device can be used to produce water for domestic use. In order to prevent contamination of domestic water with the chiller's process fluid, it is necessary to insert an intermediate heat exchanger. Using an inertial heat storage tank allows to have a reserve of preheated water and enables the intermediate exchanger to operate more efficiently.

Example of how heat recovery is used to preheat hot water for domestic use

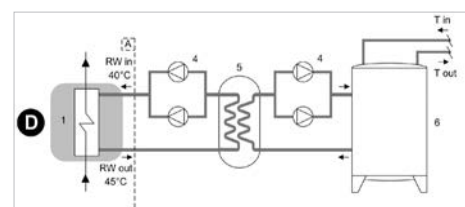

- A - Unit supply limit
- 1 - Recovery exchanger
- 3 - Auxiliary heating device (ex.boiler)
- 5 - Intermediate heat exchanger
- RW in - Recovery water input
- T in - Drinkable water inlet

- D - Partial energy recovery
- 2 - Control modulating valve
- 4 - Electric pump with standby pump
- 6 - Inertial heat storage
- RW out - Recovery water output
- T out - Drinkable water outlet to the auxiliary heater

The diagrams refer to partial energy recovery, though they also apply to total energy recovery (Clivet R). Please note that the diagrams are only meant as a guide.

# HydroPack

## 2PM/3PM - Hydronic assembly user side with 2/3 ON/OFF pumps

Option supplied on the unit. Pumping unit consisting of two or three parallel electric pumps with a self-adaptive modular activation logic.

It enables the automatic reduction of the liquid flow rate in critical conditions, avoiding blocks due to overloading and consequential intervention work by specialised technical personnel.

Centrifugal electric pump with impeller made with AISI 304 steel and AISI 304 stainless steel body or grey cast iron (depending on models).

Mechanical seal using ceramic, carbon and EPDM elastomer components.

Three-phase electric motor with IP44-protection. Complete with thermoformed insulated casing, quick connections with insulated casing, non return valve, safety valve, pressure gauges, system load safety pressure switch, stainless steel antifreeze immersion heaters located at the return and supply point.

The various models which are available can be differentiated by the system available pressure.



The 2PM / 3PM option is supplied with a kit made up of 2 quick blind connections, for the removal of one pump in case of maintenance.



Check the option compatibility table for combinations with storage tank



Provided with hydraulic interceptions to the outside of the unit (option 'CSVX - A pair of manually operated shut-off valves') to facilitate any major maintenance operations

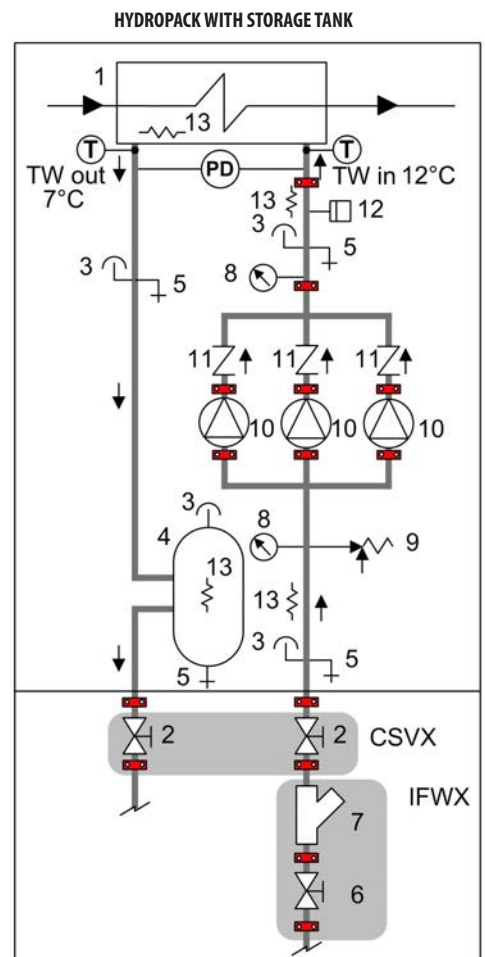
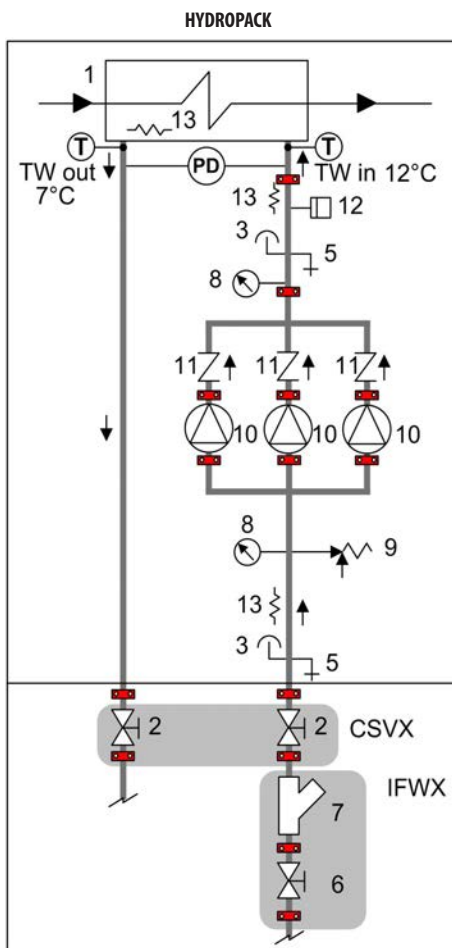

Illustrative diagram referred to unit size 240.4 with Hydronic with no. 3 of pumps

- 1 - Internal exchanger
- 2 - Cutoff valve
- 3 - Purge valve
- 4 - Storage tank with antifreeze heater
- 5 - Draw off cock
- 6 - Cutoff valve with quick joints
- 7 - Steel mesh strainer water side

- 8 - Manometer
- 9 - Safety valve (6 Bar)
- 10 - Packaged electric pump with high efficiency impeller
- 11 - Non return valve
- 12 - System safety pressure switch (prevents the pumps from operating if no water is present)
- 13 - Antifreeze heater
- T - Temperature probe
- PD - Differential pressure switch

TW in chilled water inlet  
TW out chilled water outlet

IFWX = Steel mesh strainer water side  
CSVX - Couple of manual shut-off valves

The grey area indicates further optional components.

## 2PM/3PM option performances (HydroPack)

### Head

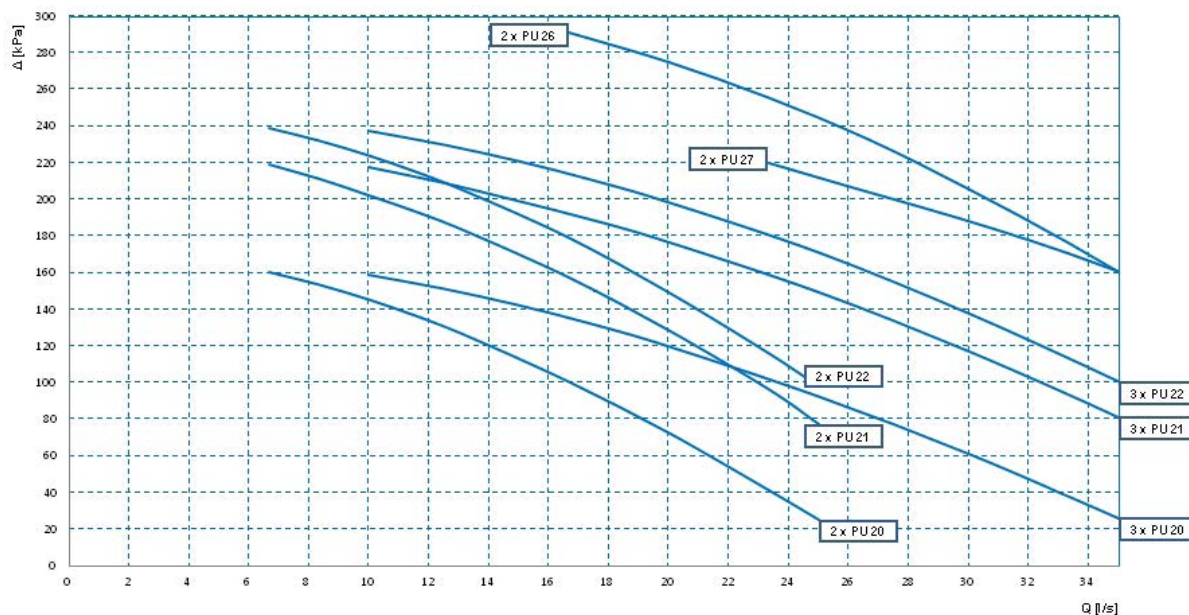

Q [l/s] = water flow rate  
 $\Delta$  [kPa] = pump head  
 PU2\* = 2-pole pump



Caution: to obtain the available pressure values, you need to subtract the following from the head values represented in these diagrams:

- User side exchanger pressure drops
- IFVX accessory –Steel mesh filter on the water side (where applicable)

### Hydropack electrical data

PUMP	Rated power [kW]	Nominal power [A]	PUMP	Rated power [kW]	Nominal power [A]
2xPU20	2x1.8	2x3.4	2xPU27	2x5.5	2x10.4
2xPU21	2x2.9	2x4.8	3xPU20	3x1.8	3x3.4
2xPU22	2x3.3	2x5.6	3xPU21	3x2.9	3x4.8
2xPU26	2x5.5	2x10.4	3xPU22	3x3.3	3x5.6

## 2PMV/3PMV - Hydronic assembly user side with 2/3 inverter pumps

Option supplied on the unit. Pumping unit consisting of parallel electric pumps and controlled by inverter to adapt to the different application conditions. It enables the automatic reduction of the liquid flow rate in critical conditions, avoiding blocks due to overloading and consequential intervention work by specialised technical personnel.



Through the inverter calibration, standard supplied, it is possible to adapt the pump flow-rate/head to the installation feature.

Centrifugal electric pump with impeller made with AISI 304 steel and AISI 304 stainless steel body or grey cast iron (depending on models).

Mechanical seal using ceramic, carbon and EPDM elastomer components.

Three-phase electric motor with IP44-protection. Complete with thermoformed insulated casing, quick connections with insulated casing, non return valve, safety valve, pressure gauges, system load safety pressure switch, stainless steel antifreeze immersion heaters located at the return and supply point.

In combination with the "IVFDT" - Variable flow-rate control option, it allows the water flow rate variation to the installation in part load operation to obtain the maximum unit efficiency and lower pumping unit consumption.

-  The 2PMV / 3PMV option is supplied with a kit made up of 2 quick blind connections, for the removal of one pump in case of maintenance.
-  Check the option compatibility table for combinations with storage tank.
-  Provided with hydraulic interceptions to the outside of the unit (option 'CSVX - A pair of manually operated shut-off valves') to facilitate any major maintenance operations

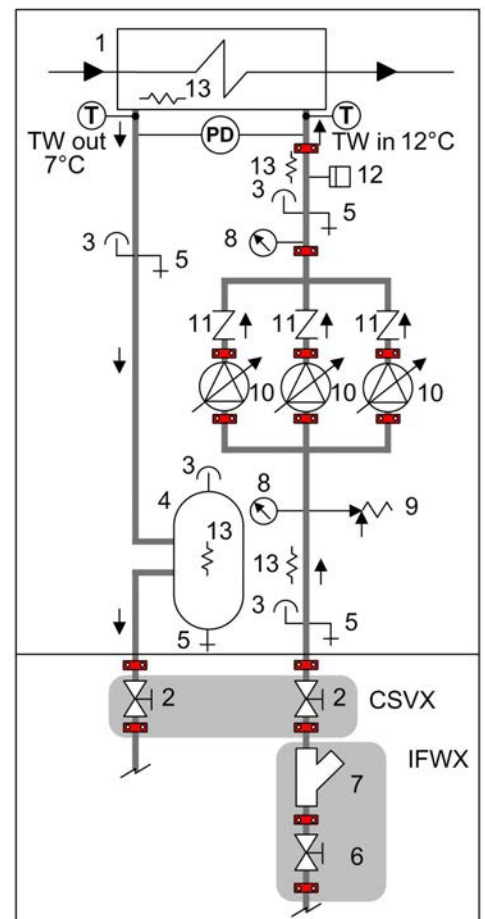
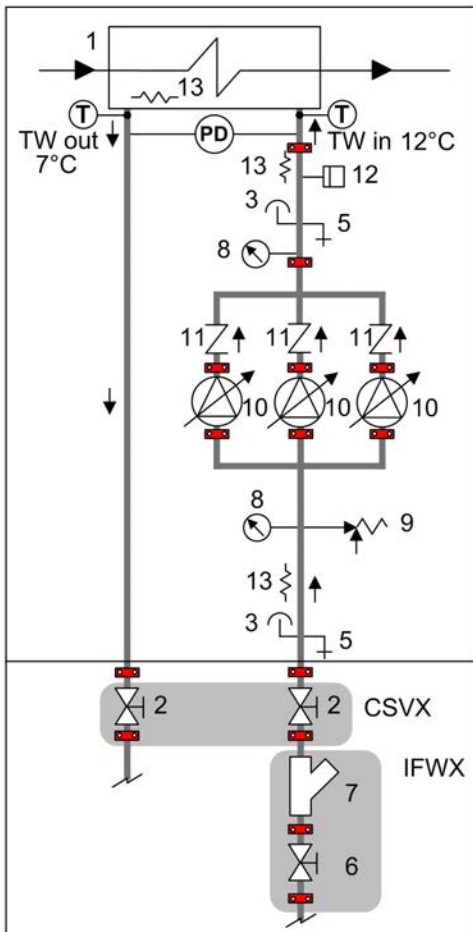

- 1 - Internal exchanger
- 2 - Cutoff valve
- 3 - Purge valve
- 4 - Storage tank
- 5 - Draw off cock
- 6 - Cutoff valve with quick joints
- 7 - Steel mesh strainer water side

- 8 - Manometer
- 9 - Safety valve (6 Bar)
- 10 - Packaged electric pump with high efficiency impeller activated by inverter
- 11 - Non return valve
- 12 - System safety pressure switch (prevents the pumps from operating if no water is present)
- 13 - Antifreeze heater

T - Temperature probe

- PD - Differential pressure switch
- TW in chilled water inlet
- TW out chilled water outlet

IFWX = Steel mesh strainer water side

CSVX - Couple of manual shut-off valves

**The grey area indicates further optional components.**

## 2PMV option performances

### Head

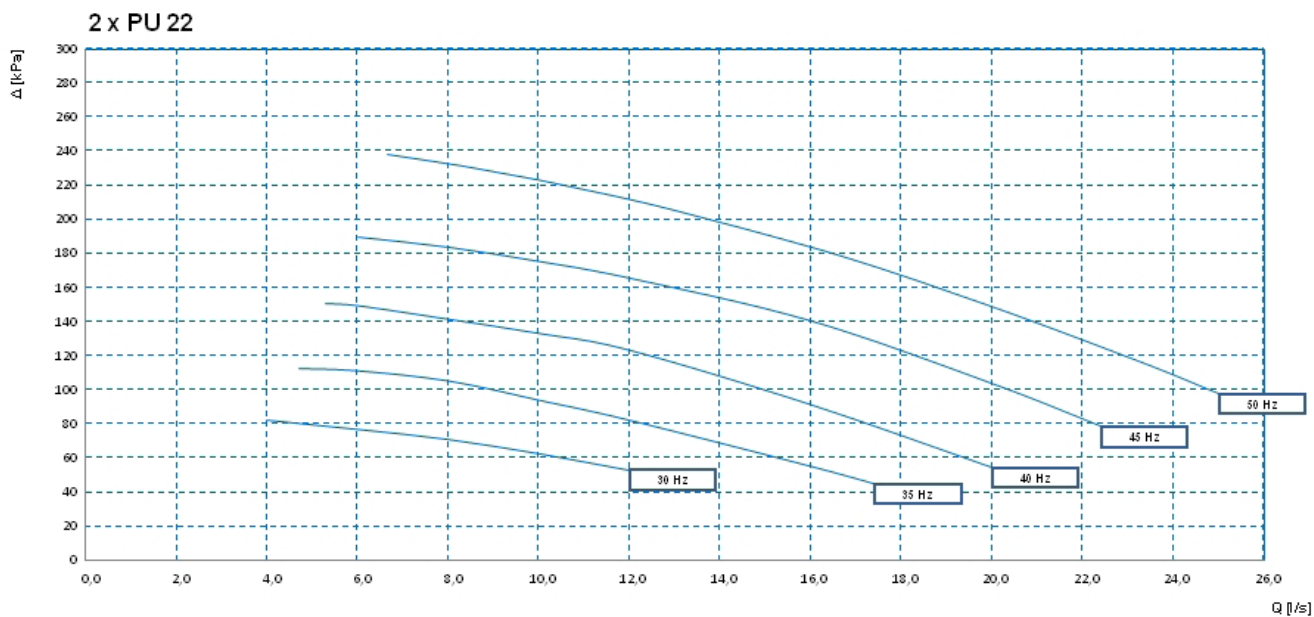

Q[l/s]= water flow rate  
 $\Delta$  [kPa] = pump head



Caution: to obtain the available pressure values, you need to subtract the following from the head values represented in these diagrams:

- internal exchanger pressure drops
- IFVX accessory –Steel mesh filter on the water side (where applicable)

### Power input

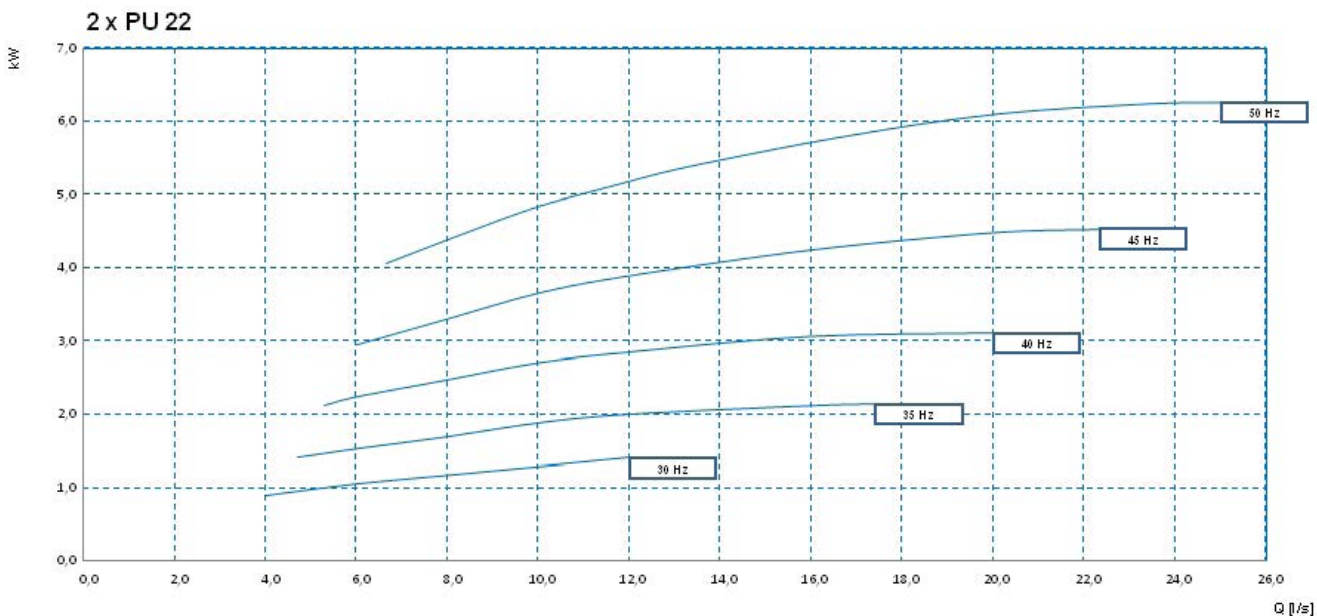

Q[l/s]= water flow rate  
 kW = power input



### 3PMV option performances

#### Head

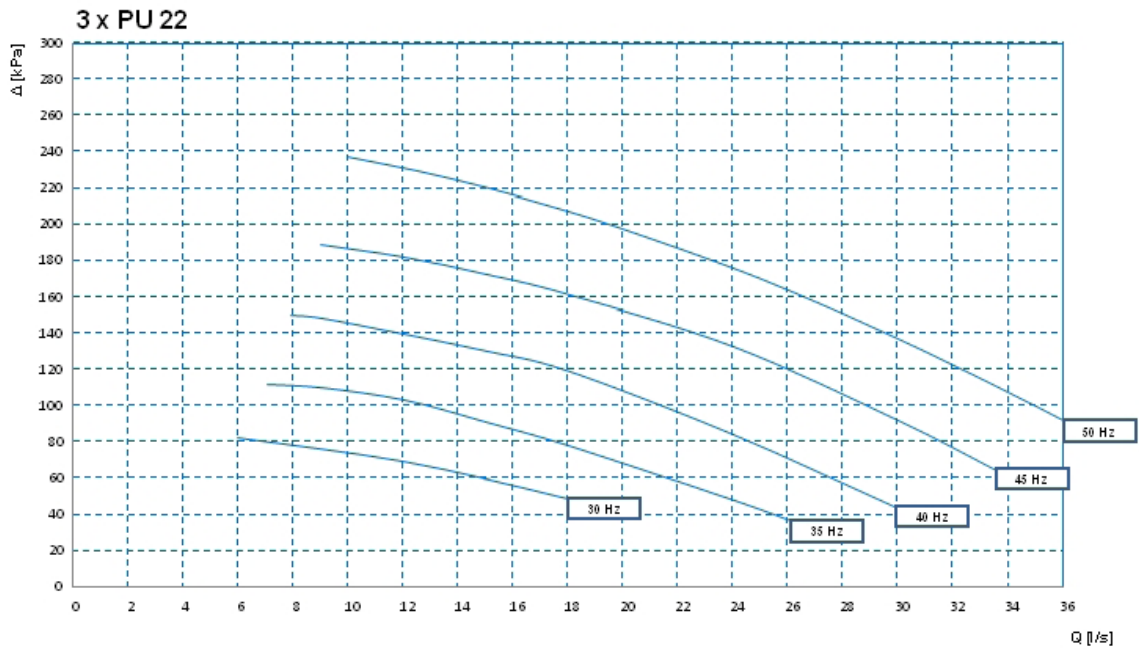

Q[l/s]= water flow rate  
 Δ [kPa] = pump head



Caution: to obtain the available pressure values, you need to subtract the following from the head values represented in these diagrams:

- internal exchanger pressure drops
- IFVX accessory –Steel mesh filter on the water side (where applicable)

#### Power input

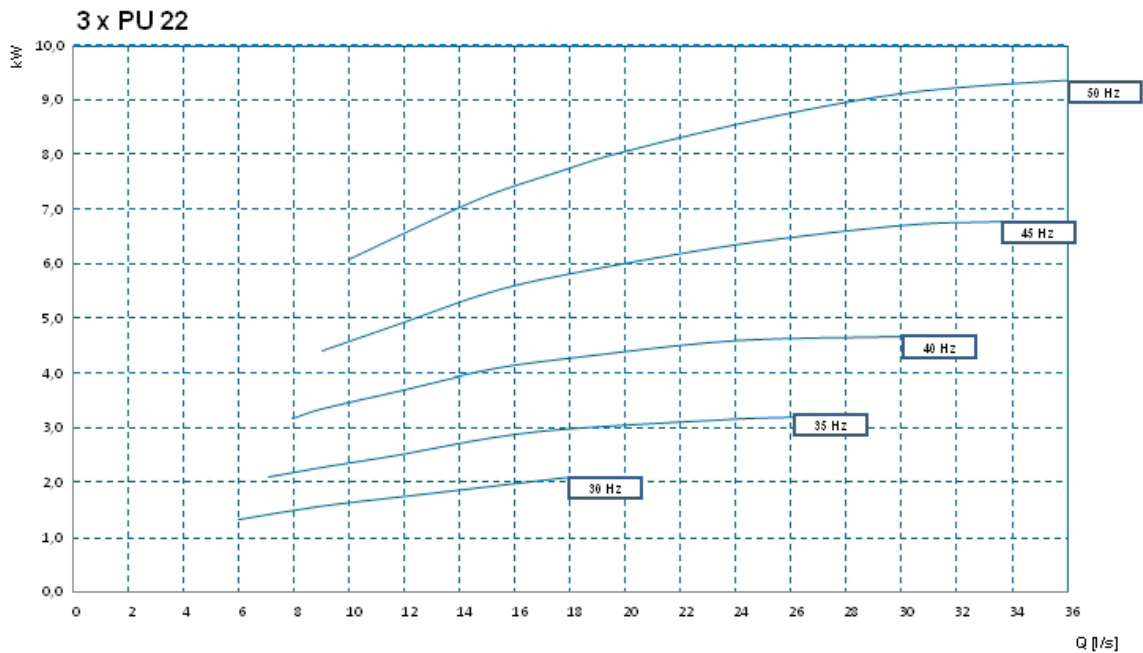

Q[l/s]= water flow rate  
 kW = power input



## Accessories - Hydronic assembly

### A550/A700/A900 - 550 / 700 / 900 l. storage tank

Option supplied built-in the unit. Steel storage tank complete with double layer covering with closed-cell insulation, stainless steel anti-freeze immersion resistance, bleed valve, draw off cock, quick connections with insulated casing. The various available models can be differentiated by capacity.

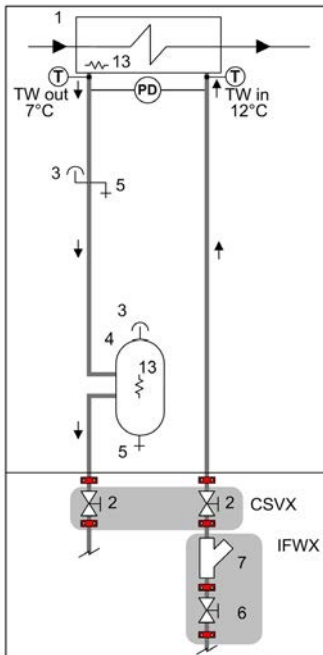

- 1 - Internal exchanger
- 2 - Cutoff valve
- 3 - Purge valve
- 4 - Storage tank with antifreeze heater
- 5 - Draw off cock
- 6 - Cutoff valve with quick joints
- 7 - Steel mesh strainer water side
- 13 - Antifreeze heater

T - Temperature probe  
PD - Differential pressure switch

TW in chilled water inlet  
TW out chilled water outlet

IFWX = Steel mesh strainer water side  
CSVX - Couple of manual shut-off valves

The grey area indicates further optional components.



Provided with hydraulic interceptions to the outside of the unit (option 'CSVX - A pair of manually operated shut-off valves') to facilitate any major maintenance operations



The water outlet user side with "Storage tank" option is positioned in correspondence of the storage tank itself. The outlet position will be defined when ordering. The water inlet user side remains in the same position of the standard unit.

### A550PPS/A700PPS/A900PPS - 550/700/900 l. storage tank with primary circuit built-in

Option supplied built-in and available only in case of special request. This accessory includes the components provided for the A550 / A700 / A900 options, as well as:

- primary circuit, already set up and tested inside the unit;
- cast-iron butterfly shut-off valve, with quick connections and activating handle and mechanical calibration lock on the pump supply.
- 2PM - HYDROPACK with no. 2 of pumps or 3PM - HYDROPACK with no. 3 of pumps according to the size

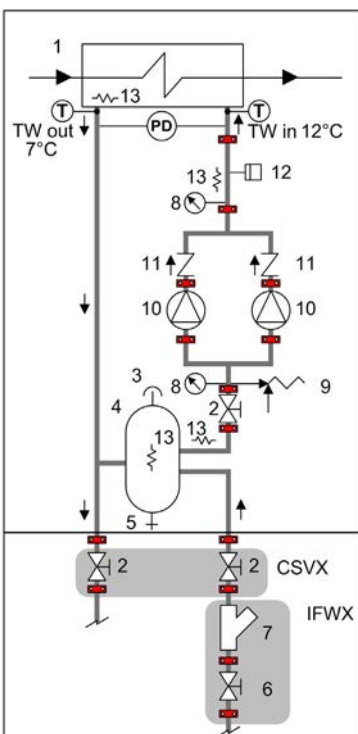

- 1 - Internal exchanger
- 2 - Cutoff valve
- 3 - Purge valve
- 4 - Storage tank with antifreeze heater
- 5 - Draw off cock
- 6 - Cutoff valve with quick joints
- 7 - Steel mesh strainer water side
- 8 - Manometer
- 9 - Safety valve (6 Bar)
- 10 - Packaged electric pump with high efficiency impeller
- 11 - Non return valve
- 12 - System safety pressure switch (prevents the pumps from operating if no water is present)
- 13 - Antifreeze heater

T - Temperature probe  
PD - Differential pressure switch

TW in chilled water inlet  
TW out chilled water outlet

IFWX = Steel mesh strainer water side  
CSVX - Couple of manual shut-off valves

The grey area indicates further optional components.



Option available only in case of special request.



The water inlet user side with "Storage tank with primary circuit with pump built-in" option is positioned in correspondence of the storage tank. The water outlet user side remains in the same position of the standard unit. The outlet position will be defined when ordering.



Attention: option not compatible with DST control logic (Dynamic Supply Temperature) activable by the User.



If the water flow rate on the primary circuit is greater than the one on the secondary circuit, this allows to directly control the supply temperature to the secondary one. Vice versa, if the water flow rate on the primary circuit is lower than the one on the secondary circuit, this means the supply water is mixed with the system's return water and therefore there is no direct control over the temperature of the chilled water produced.

## Built-in pump electrical data

Size		90.4	100.4	110.4	120.4	140.4	160.4	180.4	200.4	220.4	240.4
<b>EXCELLENCE SC</b>											
		2 x PU20	2 x PU20	2 x PU20	2 x PU20	2 x PU20	2 x PU20	2 x PU21	3 x PU20	3 x PU20	3 x PU21
FLI	[kW]	3,6	3,6	3,6	3,6	3,6	3,6	5,8	5,4	5,4	8,7
FLA	[A]	6,8	6,8	6,8	6,8	6,8	6,8	9,6	10,2	10,2	14,4
<b>EXCELLENCE EN</b>											
		2 x PU20	2 x PU20	2 x PU20	2 x PU20	2 x PU20	2 x PU20	2 x PU21	3 x PU20	3 x PU20	3 x PU20
FLI	[kW]	3,6	3,6	3,6	3,6	3,6	3,6	5,8	5,4	5,4	5,4
FLA	[A]	6,8	6,8	6,8	6,8	6,8	6,8	9,6	10,2	10,2	10,2
<b>PREMIUM SC</b>											
		2 x PU20	2 x PU20	2 x PU20	2 x PU20	2 x PU20	2 x PU20	2 x PU21	3 x PU20	3 x PU20	3 x PU20
FLI	[kW]	-	-	-	3,6	3,6	3,6	5,8	5,4	5,4	5,4
FLA	[A]	-	-	-	6,8	6,8	6,8	9,6	10,2	10,2	10,2
<b>PREMIUM EN</b>											
		2 x PU20	2 x PU20	2 x PU20	2 x PU20	2 x PU20	2 x PU20	2 x PU21	2 x PU21	3 x PU20	3 x PU20
FLI	[kW]	-	-	-	3,6	3,6	3,6	5,8	5,8	5,4	5,4
FLA	[A]	-	-	-	6,8	6,8	6,8	9,6	9,6	10,2	10,2

## IFWX - Steel mesh strainer water side

The device stops the exchanger from being clogged by any impurities which are in the hydraulic circuit. The mechanical steel mesh strainer must be placed on the water input line. It can be easily dismantled for periodical maintenance and cleaning. It also includes:

- cast-iron shut-off butterfly valve with quick connections and activation lever with a mechanical calibration lock;
- quick connections with insulated casing.

### STEEL MESH FILTER PRESSURE DROP

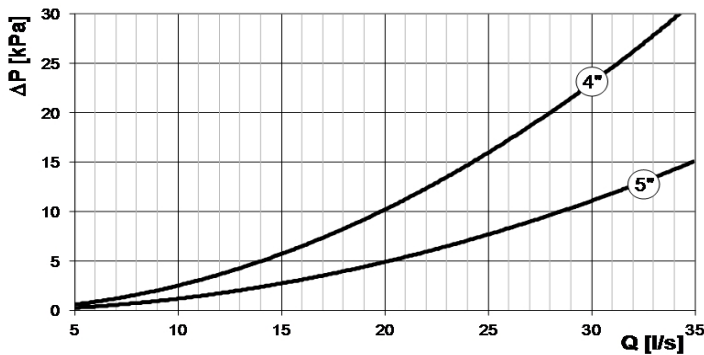

Q = water flow rate (l/s)    DP = water side pressure drop (kPa)

### STEEL MESH FILTER FEATURES

EXCELLENCE		
Diameter	4"	5"
Degree of filtration	1,6 mm	
PREMIUM		
Diameter	4"	5"
Degree of filtration	1,6 mm	



Pressure drop referred to a clean filter



Installation is the responsibility of the Client, externally to the unit



Check for the presence of the required hydraulic shut-off valves in the system, in order to undertake periodical maintenance

### Separately supplied accessory

## Accessories

### PGFC- Finned coil protection grilles

Grilles made in drawn of electro-welded steel and coated to protect the external coil from accidental contact with people and things. Ideal for installation in places where persons can pass from, such as car parks, terraces, etc.

Accessories supplied and installed on the machine.



### PGCCH - Anti-hail protection grilles

Grilles made in drawn of electro-welded steel and coated suitable to protect the external coil from hail damage.

Accessories supplied and installed on the machine.



### CCCA - Copper / aluminium condensing coil with acrylic lining

Condensing coils with copper pipes and aluminum fins with acrylic lacquering. Can be used in settings with moderately aggressive low saline concentrations and other chemical agents. The acrylic coating is used as the most economical and effective method particularly in protecting aluminum surfaces exposed to the corrosive influence of the humid and salty air in regions with marine climates.

Attention!

- Cooling capacity variation -2.7%
- Variation in compressor power input +4.2%
- Operating range reduction -2.1°C

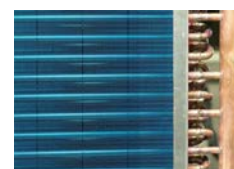

### CCCA1 - Copper / aluminium condensing coils with Aluminium Energy Guard DCC treatment

Condensing coils with copper pipes and aluminum fins with Aluminium Energy Guard DCC treatment. Complete treatment which offers an optimal thermal exchange and guarantees and protects the finned coil exchangers from corrosion over time and UV rays. Can be used in settings with very aggressive saline concentrations and other chemical agents in the air thus maintaining the performance of the coils over time and with negligible pressure drop.



### CCCC - Copper / copper condensing coil

Condensing coils with copper pipes, copper fins and brass structure. Can be used in settings with moderately aggressive saline concentrations and other chemical agents.

This option is not suitable for application in sulphuric environments

Option available only on special request

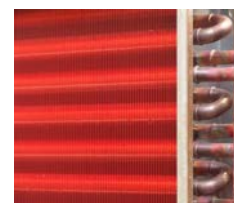

### MHP - High and low pressure gauges

It includes two liquid pressure gauges for the analog measurement of refrigerant pressures on suction and discharge lines of the compressors with pressure sockets installed in the unit in an easily accessible location.



## SDV - Cutoff valve on compressor supply and return

An option which integrates the supply cutoff valve, which is supplied as standard. The presence of the cock at the intake as well enables the compressors to be isolated and substituted without discharging the refrigerant from within the refrigeration circuit. This means that the extraordinary maintenance activities are facilitated.

Device installed built-in the unit.

1. Compressors
2. Cutoff valve
3. Safety valve
4. SDV option

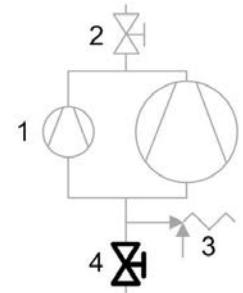

## RE-20 / RE-25 / RE-30 / RE-35 / RE-39 - Electrical panel anti-freeze protection

It includes self-regulating electric heaters with thermostat which are able to protect the electrical panel against condensation and frost guaranteeing its correct functions down to  $-39^{\circ}\text{C}$ . This accessory operates even when the unit is switched off provided that the power supply is maintained active and the unit continues to be electrically connected.

Device installed and wired built-in the unit.



This accessory operates even when the unit is switched off provided that the power supply is maintained active and the unit continues to be connected.



This accessory does not lead to substantial variations in the electrical data for the unit which has been declared in the Electrical Data section.



## MF2 - Multifunction phase monitor (PREMIUM version only)

The phase monitor controls the electrical parameters of the power line to the unit. It works on the command circuit and orders the unit to be switched off when one of the following cases is present: when the phase connections do not respect the correct sequence, or when there is over voltage or under voltage for a certain amount of time: limit values of over and under voltage and the time interval can be manually and separately set. When the line conditions are re-established, the unit is re-armed automatically.

Device installed and wired built-in the unit.



This accessory is available only in the PREMIUM version. Supplied as standard in the EXCELLENCE version



The device prevents sudden changes of voltage; however, the voltage must always be in a range between 380V and 480V.



## PFCP - Power-factor correction capacitors (cosfi > 0.9)

The component is necessary to lower the phase difference between current and voltage in the electromagnetic components of the unit (e.g. asynchronous motors). The component allows to put the cosfi power factor to values on average higher than 0.9, reducing the network reactive power. This often leads to an economic benefit which the energy provider grants to the final user.

The device is installed and wired built-in the unit.



## ECS - ECOSHARE function for the automatic management of a group of units

Device allows automatic management of units that operate on the same hydraulic circuit, by creating a local communication network. There are three control modes that can be set via a parameter during the units start-up. Two control modes distribute the heat load on the available units by following the distribution logic to benefit of efficiency levels at part load and one shift the supply water set-point temperature on the group of units.

Moreover:

Mode 0 - shift the water set-point temperature and keeps all the pumps active;

Mode 1 - distribute the heat load and keeps all the pumps active;

Mode 2 - distribute the heat load and activates only the pumps of the unit required to operate.

The device allows for rotation based on the criterion of minimum wear and management of units in stand-by. In case of failure of one unit the load is distributed in the other units.

The units can be of various sizes but of the same type: all reversible heat pumps, or all air-cooled liquid chiller. The set of units is controlled by a Master unit. The local network can be extended up to 7 units (1 Master and 6 Slave).



The unit supplied with this device can also be equipped at the same time with the RCMRX option and one of the CMSC8 / CMSC9 / CMSC10 options.

## SFSTR – Disposal for inrush current reduction (SOFT STARTER)

Electronic device which automatically starts up the compressors gradually, reducing the starting current for the unit by around 40% in comparison with the nominal value. This results in the reduction of the starting torque of the ON/OFF compressor, it is more protected from mechanical stresses leading to an increased life of the component. The noise is also reduced.

Device installed and wired built-in the unit.



In sizes 180.4, 200.4, 220.4 and 240.4 the larger size compressor is standard equipped with device for progressive start-up, defined part-winding. For these units the soft-starter benefits are guaranteed on lower size compressors, maintaining unchanged the M.I.C. (max. inrush current) of the standard unit.



The compressors with 60 HP of nominal capacity need the standard device for the progressive start-up defined part-winding.

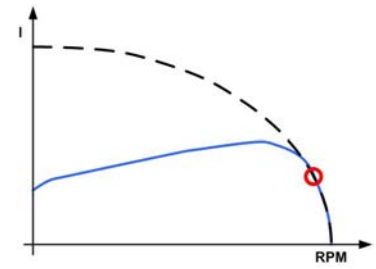

--- Absorbed current without SFSTR option  
 — Absorbed current with SFSTR option

## CMSC11 - Serial communication module for BACnet supervisor

Module allows the serial connection of the supervision system, using BACnet/IP as the communication protocol. It enables access to the complete list of operational variables, commands and alarms. Using this accessory every unit can dialogue with the main supervision systems.

Device installed and wired built-in the unit.



The configuration and management activities for the BACnet networks are the responsibility of the client.



The total length of each serial line do not exceed 1000 meters and the line must be connected in bus typology (in/out)

## CMSC9 - Serial communication module for Modbus supervisor

Module allows the serial connection of the supervision system, using Modbus as the communication protocol. It enables access to the complete list of operational variables, commands and alarms. Using this accessory every unit can dialogue with the main supervision systems.

Device installed and wired built-in the unit



The total length of each serial line do not exceed 1000 meters and the line must be connected in bus typology (in/out)

## CMSC10 - Serial communication module for LonWorks supervisor

Module allows the serial connection of the supervision system which uses the LonWorks communication protocol. It enables access to a list of operating variables, commands and alarms which comply with the Echelon® standard.

Device installed and wired built-in the unit.



The configuration and management activities for the LonWorks networks are the responsibility of the client.



LonWorks technology uses the LonTalk® protocol for communicating between the network nodes. Contact the service supplier for further information.



The total length of each serial line do not exceed 1000 meters and the line must be connected in bus typology (in/out)

## CREFB - Device for fan consumption reduction of the external section, ECOBREEZE type

An option which regards the external helical fans, as an alternative to the phase-cut device which is supplied as standard in SC and EN version. It provides for an IP54 brushless electronically commutated electrical motor and incorporated thermal protection. Supplied with variable speed control.

## REGBT - Device for the condensing coil partialization

Electronic device supplied on the unit allows to extend the unit operating range in cooling down to an outdoor air temperature of -18°C. For good operation of the unit at low outdoor temperatures, the fan motors speed is continuously adjusted as well as the finned exchange surface according to the condensing pressure.

It has to be matched to CREFB option.

## CONTA2 - Energy meter

Allows to display and record the unit's main electrical parameters. The data can be displayed on the device display or via the supervisor through the specific protocol variables..

It is possible to control:

- voltage (V),
- absorbed current (A),
- frequency (Hz),
- cosφi,
- power input (KW),
- absorbed energy (KWh),
- harmonic components (%).

The device is installed and wired built-in the unit.



On the device is present a serial port with Modbus protocol for the connection to the supervision system.

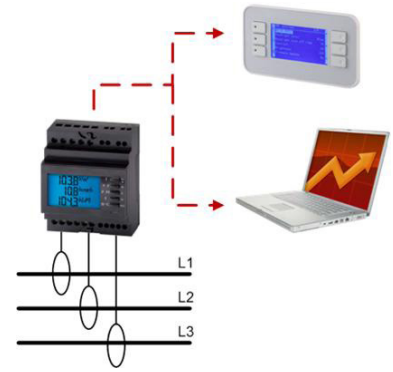

## SCP4 - Set-point compensation with 0-10 V signal

Device allows the changing of the preset set point by means to an external 0÷10 V signal. The interruption of the signal the set-point is at the nominal set value. The limit values can be changed within wide values.

Device installed and wired built-in the unit.



## SPC2 - Set-point compensation with outdoor air temperature probe

Device allows the automatic regulation of the preset set-point depending of the outside temperature air measured by the unit probe. This device allows to get the sliding supply water temperature, which varies depending on external conditions, enabling energy savings throughout the entire system.

Device installed and wired built-in the unit.

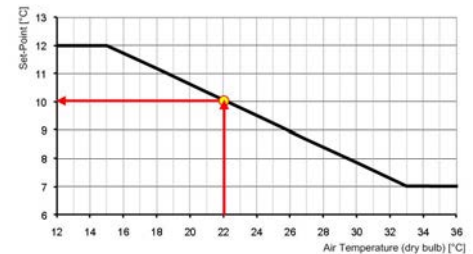

## IVFDT - Inverter driven variable flow-rate user side control depending on the temperature differential

This option allows water flow-rate modulation to the unit during partial load conditions, maintaining stable the temperature difference between inlet and outlet to the heat exchanger.

The option is available only when the unit thermoregulation is set on the return temperature.

Designed for systems with primary circuit variable flow-rate systems decoupled from secondary circuit. With no building load the unit switches off the compressors while concerning pumps is possible to select:

- Active pumps with minimum flow-rate, monitoring secondary circuit temperature variations
- Pump switching off, periodically activating them (settable time) leading secondary circuit temperatures on primary circuit
- Pump switching off and waiting for the user signal for activation (free potential)

Flow-rate modulation is managed by embedded logic thanks to built-in flow-rate control device and temperature probes. This device is installed and wired.



This option is available only with inverter driven HYDROPACK selected (2PMV / 3PMV)



The airow control is active only with thermoregulation on the return temperature



## RPRPDI - Refrigerant leak detector with pump down function in the casing

Leak detector device built-in installed and placed inside the compressor box. It detects leaks of the internal refrigeration circuit and automatically enables the "pump-down" function, storing the refrigerant inside the finned coil exchanger. During pump-down, cooling capacity is not produced by the unit. At the end of the operation the unit is switched off and a dedicated alarm signal is available directly inside the electrical panel.

The device respects BREEAM regulations.

## Accessories separately supplied

### CSVX - Couple of manual shut-off valves

Kit composed of:

- no. 2 cast-iron shut-off butterfly valves, it includes: fast fittings and activation lever with a mechanical calibration lock
- no. 2 of Victaulic type quick connection with insulated casing to isolate the hydraulic circuit at the inlet and outlet



Installation is the responsibility of the Client, externally to the unit.

### RCMRX - Remote control via microprocessor remote control

This option allows to have full control over all the unit functions from a remote position.

It can be easily installed on the wall and has the same aspect and functions of the user interface on the unit.

All device functions can be repeated with a normal portable PC connected to the unit with an Ethernet cable and equipped with an internet navigation browser.

The device must be installed on the wall with suitable plugs and connected to the unit (installation and wiring to be conducted by the Customer). Maximum remote control distance 350 m without auxiliary power supply. For distances greater than 350 m and in any case less than 700 m it is necessary to install the 'PSX - Mains power unit' accessory.

Data and power supply serial connection cable n.1 twisted and shielded pair. Diameter of the individual conductor 0.8 mm.

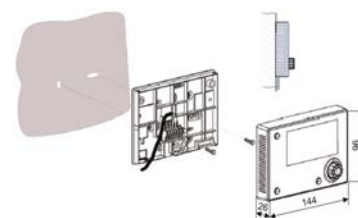

### PSX - Mains power supply unit

The device allows the unit and the remote control to communicate with the user interface even when the serial line is longer than 350m.

It must be connected to the serial line at a distance of 350m from the unit and allows to extend the length to 700m maximum in total. The device requires an external power supply at 230V AC.

Power supply at 230V AC provided by Customer



### AMMX - Spring antivibration mounts

The spring antivibration mounts are attached in special housing on the support frame and serve to smooth the vibrations produced by the unit thus reducing the noise transmitted to the support structure..



# Option compatibility - EXCELLENCE version

## Acoustic configuration: compressor soundproofing (SC)

REFERENCE	DESCRIPTION	90.4	100.4	110.4	120.4	140.4	160.4	180.4	200.4	220.4	240.4
<b>CONFIGURATIONS AND MAIN ACCESSORIES</b>											
B	Water low temperature	0	0	0	0	0	0	0	0	0	0
D	Partial energy recovery	0	0	0	0	0	0	0	0	0	0
R	Total energy recovery	0	0	0	0	0	0	0	0	0	0
B + D	Water low temperature + Partial energy recovery	0	0	0	0	0	0	0	0	0	0
B + R	Water low temperature + Total energy recovery	0	0	0	0	0	0	0	0	0	0
A550	550 l. storage tank	0	0	0	0	-	-	-	-	-	-
A700	700 l. storage tank	-	-	-	-	0	0	0	-	-	-
A900	900 l. storage tank	-	-	-	-	-	-	-	0	0	0
<b>STORAGE TANK AND PUMP WITH PRIMARY CIRCUIT BUILT-IN</b>											
A550PPS	550 l. storage tank with primary circuit with pump built-in	◇	◇	◇	◇	-	-	-	-	-	-
A700PPS	700 l. storage tank with primary circuit with pump built-in	-	-	-	-	◇	◇	◇	-	-	-
A900PPS	900 l. storage tank with primary circuit with pump built-in	-	-	-	-	-	-	-	◇	◇	◇
<b>2PM - HYDROPACK USER SIDE WITH 2 PUMPS</b>											
(PU20)	Pump 20	0	0	0	0	0	-	-	-	-	-
(PU21) / (PU22)	Pump 21 / Pump 22	0	0	0	0	0	0	0	-	-	-
(PU26)	Pump 26	-	-	-	-	-	0	0	0	0	0
+ A550PPS	+ 550 l. storage tank with primary circuit with pump built-in	-	-	-	-	-	-	-	-	-	-
+ A700PPS	+ 700 l. storage tank with primary circuit with pump built-in	-	-	-	-	-	-	-	-	-	-
+ A900PPS	+ 900 l. storage tank with primary circuit with pump built-in	-	-	-	-	-	-	-	-	-	-
+ A550	+ 550 l. storage tank	0	0	0	0	-	-	-	-	-	-
+ A700	+ 700 l. storage tank	-	-	-	-	0	0	0	-	-	-
+ A900	+ 900 l. storage tank	-	-	-	-	-	-	-	0	0	0
<b>3PM - HYDROPACK USER SIDE WITH 3 PUMPS</b>											
(PU20)	Pump 20	-	-	-	-	-	-	0	0	0	-
(PU21)	Pump 21	-	-	-	0	0	0	0	0	0	0
(PU22)	Pump 22	0	0	0	0	0	0	0	0	0	0
+ A550PPS	+ 550 l. storage tank with primary circuit with pump built-in	-	-	-	-	-	-	-	-	-	-
+ A700PPS	+ 700 l. storage tank with primary circuit with pump built-in	-	-	-	-	-	-	-	-	-	-
+ A900PPS	+ 900 l. storage tank with primary circuit with pump built-in	-	-	-	-	-	-	-	-	-	-
+ A550	+ 550 l. storage tank	0	0	0	0	-	-	-	-	-	-
+ A700	+ 700 l. storage tank	-	-	-	-	0	0	0	-	-	-
+ A900	+ 900 l. storage tank	-	-	-	-	-	-	-	0	0	0
<b>2PMV - HYDROPACK USER SIDE WITH NO.2 OF INVERTER PUMPS</b>											
(PU22)	Pump 22	0	0	0	0	-	-	-	-	-	-
<b>3PMV - HYDROPACK USER SIDE WITH NO.3 OF INVERTER PUMPS</b>											
(PU22)	Pump 22	0	0	0	0	0	0	0	0	0	0
<b>IVFDT - INVERTER DRIVEN VARIABLE FLOW-RATE USER SIDE CONTROL DEPENDING ON THE TEMPERATURE DIFFERENTIAL</b>											
(2PM) / (3PM)	Hydropack user side with no. 2 of pumps / Hydropack user side with no. 3 of pumps	-	-	-	-	-	-	-	-	-	-
(2PMV) / (3PMV)	Hydropack user side with no.2 of inverter pumps / Hydropack user side with no.3 of inverter pumps	0*	0*	0*	0*	0*	0*	0*	0*	0*	0*
<b>OTHER ACCESSORIES</b>											
CREFB	Device for fan consumption reduction of the external section, ECOBREEZE type	0	0	0	0	0	0	0	0	0	0
CREFP	Device for consumption reduction of the external section at variable speed (phase-cutting)	•	•	•	•	•	•	•	•	•	•

• Standard

0 Option

- Not available

0\* Necessary matching: variable flow-rate control and built-in inverter pumps

◇ Option available only on special request.

## Option compatibility - PREMIUM version

### Acoustic configuration: compressor soundproofing (SC)

REFERENCE	DESCRIPTION	120.4	140.4	160.4	180.4	200.4	220.4	240.4
<b>CONFIGURATIONS AND MAIN ACCESSORIES</b>								
B	Water low temperature	0	0	0	0	0	0	0
D	Partial energy recovery	0	0	0	0	0	0	0
R	Total energy recovery	0	0	0	0	0	0	0
B + D	Water low temperature + Partial energy recovery	0	0	0	0	0	0	0
B + R	Water low temperature + Total energy recovery	0	0	0	0	0	0	0
A550	550 l. storage tank	0	0	0	-	-	-	-
A700	700 l. storage tank	-	-	-	0	0	-	-
A900	900 l. storage tank	-	-	-	-	-	0	0
<b>STORAGE TANK AND PUMP WITH PRIMARY CIRCUIT BUILT-IN</b>								
A550PPS	550 l. storage tank with primary circuit with pump built-in	◇	◇	◇	-	-	-	-
A700PPS	700 l. storage tank with primary circuit with pump built-in	-	-	-	◇	◇	-	-
A900PPS	900 l. storage tank with primary circuit with pump built-in	-	-	-	-	-	◇	◇
<b>2PM - HYDROPACK USER SIDE WITH 2 PUMPS</b>								
(PU20)	Pump 20	0	0	0	-	-	-	-
(PU21) / (PU22)	Pump 21 / Pump 22	0	0	0	0	-	-	-
(PU26)	Pump 26	-	-	-	0	0	0	0
+ A550PPS	+ 550 l. storage tank with primary circuit with pump built-in	-	-	-	-	-	-	-
+ A700PPS	+ 700 l. storage tank with primary circuit with pump built-in	-	-	-	-	-	-	-
+ A900PPS	+ 900 l. storage tank with primary circuit with pump built-in	-	-	-	-	-	-	-
+ A550	+ 550 l. storage tank	0	0	0	-	-	-	-
+ A700	+ 700 l. storage tank	-	-	-	0	0	-	-
+ A900	+ 900 l. storage tank	-	-	-	-	-	0	0
<b>3PM - HYDROPACK USER SIDE WITH 3 PUMPS</b>								
(PU20)	Pump 20	-	-	-	-	0	0	-
(PU21)	Pump 21	-	-	0	0	0	0	0
(PU22)	Pump 22	0	0	0	0	0	0	0
+ A550PPS	+ 550 l. storage tank with primary circuit with pump built-in	-	-	-	-	-	-	-
+ A700PPS	+ 700 l. storage tank with primary circuit with pump built-in	-	-	-	-	-	-	-
+ A900PPS	+ 900 l. storage tank with primary circuit with pump built-in	-	-	-	-	-	-	-
+ A550	+ 550 l. storage tank	0	0	0	-	-	-	-
+ A700	+ 700 l. storage tank	-	-	-	0	0	-	-
+ A900	+ 900 l. storage tank	-	-	-	-	-	0	0
<b>2PMV - HYDROPACK USER SIDE WITH NO.2 OF INVERTER PUMPS</b>								
(PU22)	Pump 22	0	-	-	-	-	-	-
<b>3PMV - HYDROPACK USER SIDE WITH NO.3 OF INVERTER PUMPS</b>								
(PU22)	Pump 22	0	0	0	0	0	0	0
<b>IVFDT - INVERTER DRIVEN VARIABLE FLOW-RATE USER SIDE CONTROL DEPENDING ON THE TEMPERATURE DIFFERENTIAL</b>								
(2PM) / (3PM)	Hydropack user side with no. 2 of pumps / Hydropack user side with no. 3 of pumps	-	-	-	-	-	-	-
(2PMV) / (3PMV)	Hydropack user side with no.2 of inverter pumps / Hydropack user side with no.3 of inverter pumps	0*	0*	0*	0*	0*	0*	0*
<b>OTHER ACCESSORIES</b>								
CREFB	Device for fan consumption reduction of the external section, ECOBREEZE type	0	0	0	0	0	0	0
CREFP	Device for consumption reduction of the external section at variable speed (phase-cutting)	•	•	•	•	•	•	•

• Standard

0 Option

- Not available

0\* Necessary matching: variable flow-rate control and built-in inverter pumps

◇ Option available only on special request.

# Option compatibility - EXCELLENCE version

## Acoustic configuration: super-silenced (EN)

REF.	DESCRIPTION	90.4	100.4	110.4	120.4	140.4	160.4	180.4	200.4	220.4	240.4
<b>CONFIGURATIONS AND MAIN ACCESSORIES</b>											
B	Water low temperature	0	0	0	0	0	0	0	0	0	0
D	Partial energy recovery	0	0	0	0	0	0	0	0	0	0
R	Total energy recovery	0	0	0	0	0	0	0	0	0	0
B + D	Water low temperature + Partial energy recovery	0	0	0	0	0	0	0	0	0	0
B + R	Water low temperature + Total energy recovery	0	0	0	0	0	0	0	0	0	0
A550	550 l. storage tank	0	0	0	0	-	-	-	-	-	-
A700	700 l. storage tank	-	-	-	-	0	0	0	-	-	-
A900	900 l. storage tank	-	-	-	-	-	-	-	0	0	0
<b>STORAGE TANK AND PUMP WITH PRIMARY CIRCUIT BUILT-IN</b>											
A550PPS	550 l. storage tank with primary circuit with pump built-in	◇	◇	◇	◇	-	-	-	-	-	-
A700PPS	700 l. storage tank with primary circuit with pump built-in	-	-	-	-	◇	◇	◇	-	-	-
A900PPS	900 l. storage tank with primary circuit with pump built-in	-	-	-	-	-	-	-	◇	◇	◇
<b>2PM - HYDROPACK USER SIDE WITH 2 PUMPS</b>											
(PU20)	Pump 20	0	0	0	0	0	0	-	-	-	-
(PU21) / (PU22)	Pump 21 / Pump 22	0	0	0	0	0	0	0	-	-	-
(PU27)	Pump 27	-	-	-	-	-	-	-	-	0	0
+ A550PPS	+ 550 l. storage tank with primary circuit with pump built-in	-	-	-	-	-	-	-	-	-	-
+ A700PPS	+ 700 l. storage tank with primary circuit with pump built-in	-	-	-	-	-	-	-	-	-	-
+ A900PPS	+ 900 l. storage tank with primary circuit with pump built-in	-	-	-	-	-	-	-	-	-	-
+ A550	+ 550 l. storage tank	0	0	0	0	-	-	-	-	-	-
+ A700	+ 700 l. storage tank	-	-	-	-	0	0	0	-	-	-
+ A900	+ 900 l. storage tank	-	-	-	-	-	-	-	0	0	0
<b>3PM - HYDROPACK USER SIDE WITH 3 PUMPS</b>											
(PU20)	Pump 20	-	-	-	-	-	-	-	0	0	-
(PU21)	Pump 21	-	-	-	0	0	0	0	0	0	0
(PU22)	Pump 22	0	0	0	0	0	0	0	0	0	0
+ A550PPS	+ 550 l. storage tank with primary circuit with pump built-in	-	-	-	-	-	-	-	-	-	-
+ A700PPS	+ 700 l. storage tank with primary circuit with pump built-in	-	-	-	-	-	-	-	-	-	-
+ A900PPS	+ 900 l. storage tank with primary circuit with pump built-in	-	-	-	-	-	-	-	-	-	-
+ A550	+ 550 l. storage tank	0	0	0	0	-	-	-	-	-	-
+ A700	+ 700 l. storage tank	-	-	-	-	0	0	0	-	-	-
+ A900	+ 900 l. storage tank	-	-	-	-	-	-	-	0	0	0
<b>2PMV - HYDROPACK USER SIDE WITH NO.2 OF INVERTER PUMPS</b>											
(PU22)	Pump 22	0	0	0	0	-	-	-	-	-	-
<b>3PMV - HYDROPACK USER SIDE WITH NO.3 OF INVERTER PUMPS</b>											
(PU22)	Pump 22	0	0	0	0	0	0	0	0	0	0
<b>IVFDT - INVERTER DRIVEN VARIABLE FLOW-RATE USER SIDE CONTROL DEPENDING ON THE TEMPERATURE DIFFERENTIAL</b>											
(2PM) / (3PM)	Hydropack user side with no. 2 of pumps / Hydropack user side with no. 3 of pumps	-	-	-	-	-	-	-	-	-	-
(2PMV) / (3PMV)	Hydropack user side with no.2 of inverter pumps / Hydropack user side with no.3 of inverter pumps	0*	0*	0*	0*	0*	0*	0*	0*	0*	0*
<b>OTHER ACCESSORIES</b>											
CREFB	Device for fan consumption reduction of the external section, ECOBREEZE type	0	0	0	0	0	0	0	0	0	0
CREFP	Device for consumption reduction of the external section at variable speed (phase-cutting)	•	•	•	•	•	•	•	•	•	•

• Standard

0 Option

- Not available

0\* Necessary matching: variable flow-rate control and built-in inverter pumps

◇ Option available only on special request.

## Option compatibility - PREMIUM version

### Acoustic configuration: super-silenced (EN)

REF.	DESCRIPTION	120.4	140.4	160.4	180.4	200.4	220.4	240.4
<b>CONFIGURATIONS AND MAIN ACCESSORIES</b>								
B	Water low temperature	0	0	0	0	0	0	0
D	Partial energy recovery	0	0	0	0	0	0	0
R	Total energy recovery	0	0	0	0	0	0	0
B + D	Water low temperature + Partial energy recovery	0	0	0	0	0	0	0
B + R	Water low temperature + Total energy recovery	0	0	0	0	0	0	0
A550	550 l. storage tank	0	0	0	-	-	-	-
A700	700 l. storage tank	-	-	-	0	0	-	-
A900	900 l. storage tank	-	-	-	-	-	0	0
<b>STORAGE TANK AND PUMP WITH PRIMARY CIRCUIT BUILT-IN</b>								
A550PPS	550 l. storage tank with primary circuit with pump built-in	◇	◇	◇	-	-	-	-
A700PPS	700 l. storage tank with primary circuit with pump built-in	-	-	-	◇	◇	-	-
A900PPS	900 l. storage tank with primary circuit with pump built-in	-	-	-	-	-	◇	◇
<b>2PM - HYDROPACK WITH 2 PUMPS</b>								
(PU20)	Pump 20	0	0	0	-	-	-	-
(PU21) / (PU22)	Pump 21 / Pump 22	0	0	0	0	0	-	-
(PU27)	Pump 27	-	-	-	-	-	0	0
+ A550PPS	+ 550 l. storage tank with primary circuit with pump built-in	-	-	-	-	-	-	-
+ A700PPS	+ 700 l. storage tank with primary circuit with pump built-in	-	-	-	-	-	-	-
+ A900PPS	+ 900 l. storage tank with primary circuit with pump built-in	-	-	-	-	-	-	-
+ A550	+ 550 l. storage tank	0	0	0	-	-	-	-
+ A700	+ 700 l. storage tank	-	-	-	0	0	-	-
+ A900	+ 900 l. storage tank	-	-	-	-	-	0	0
<b>3PM - HYDROPACK WITH 3 PUMPS</b>								
(PU20)	Pump 20	-	-	-	-	-	0	0
(PU21)	Pump 21	-	-	-	0	0	0	0
(PU22)	Pump 22	0	0	0	0	0	0	0
+ A550PPS	+ 550 l. storage tank with primary circuit with pump built-in	-	-	-	-	-	-	-
+ A700PPS	+ 700 l. storage tank with primary circuit with pump built-in	-	-	-	-	-	-	-
+ A900PPS	+ 900 l. storage tank with primary circuit with pump built-in	-	-	-	-	-	-	-
+ A550	+ 550 l. storage tank	0	0	0	-	-	-	-
+ A700	+ 700 l. storage tank	-	-	-	0	0	-	-
+ A900	+ 900 l. storage tank	-	-	-	-	-	0	0
<b>2PMV - HYDROPACK USER SIDE WITH NO.2 OF INVERTER PUMPS</b>								
(PU22)	Pump 22	0	-	-	-	-	-	-
<b>3PMV - HYDROPACK USER SIDE WITH NO.3 OF INVERTER PUMPS</b>								
(PU22)	Pump 22	0	0	0	0	0	0	0
<b>IVFDT - INVERTER DRIVEN VARIABLE FLOW-RATE USER SIDE CONTROL DEPENDING ON THE TEMPERATURE DIFFERENTIAL</b>								
(2PM) / (3PM)	Hydropack user side with no. 2 of pumps / Hydropack user side with no. 3 of pumps	-	-	-	-	-	-	-
(2PMV) / (3PMV)	Hydropack user side with no.2 of inverter pumps / Hydropack user side with no.3 of inverter pumps	0*	0*	0*	0*	0*	0*	0*
<b>OTHER ACCESSORIES</b>								
CREFB	Device for fan consumption reduction of the external section, ECOBREEZE type	0	0	0	0	0	0	0
CREFP	Device for consumption reduction of the external section at variable speed (phase-cutting)	•	•	•	•	•	•	•

• Standard

0 Option

- Not available

0\* Necessary matching: variable flow-rate control and built-in inverter pumps

◇ Option available only on special request.

# Dimensional drawings

Size 90.4-120.4 - EXCELLENCE version - Size 120.4-160.4 - PREMIUM version

Acoustic configuration : Compressor soundproofing (SC) / Super-silenced (EN)

DAB8T90 4\_120 4\_EXC\_PRM\_SC\_EN\_1  
Data/Date 04/08/2016

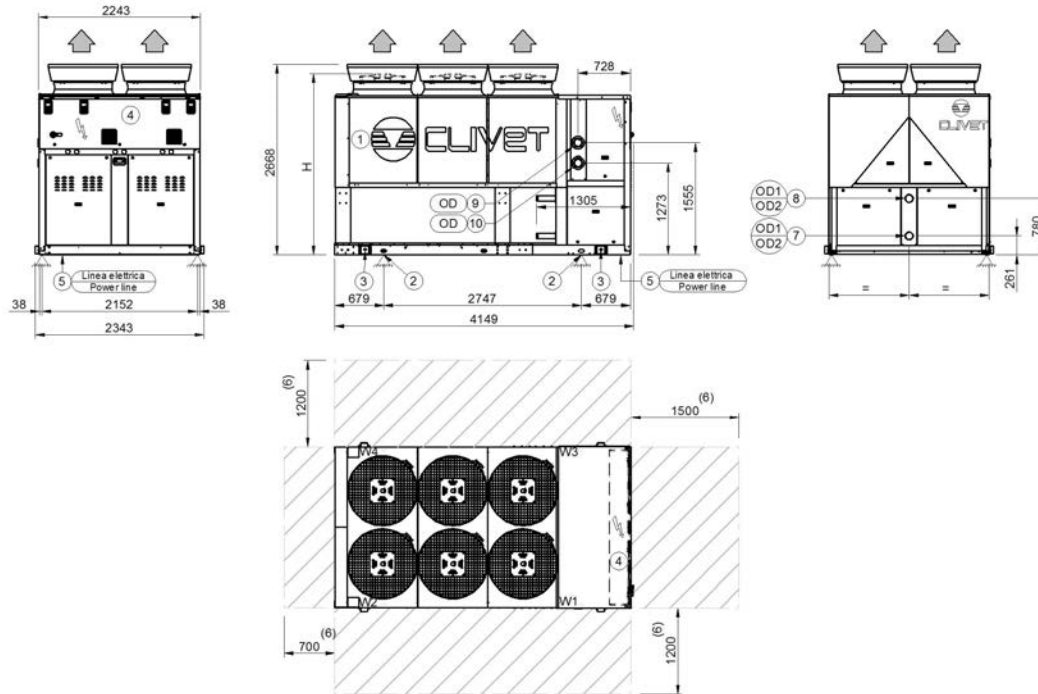

- 1. External exchanger (condenser)
- 2. Antivibration fixing holes  $\varnothing$  25mm
- 3. Lifting brackets (removable, if required, after positioning the unit)
- 4. General electrical panel
- 5. Power input
- 6. Suggested clearance
- 7. Recovery side exchanger water inlet (optional)
- 8. Recovery side exchanger water outlet (optional)
- 9. Water inlet user side of no pumps unit / Water outlet user side of unit with pumps (optional)
- 10. Water outlet user side of no pumps unit / Water inlet user side of unit with pumps (optional)

Size		SC-EXC				SC-PRM			EN-EXC				EN-PRM		
		90.4	100.4	110.4	120.4	120.4	140.4	160.4	90.4	100.4	110.4	120.4	120.4	140.4	160.4
H (without Axitop)	mm	2484	2484	2484	2484	2484	2484	2484	2484	2484	2484	2484	2484	2484	2484
H (without Axitop with ECOBREEZE - optional)	mm	2510	2510	2510	2510	2510	2510	2510	2510	2510	2510	2510	2510	2510	2510
OD (internal exchanger)	mm	114,3	114,3	114,3	114,3	114,3	114,3	114,3	114,3	114,3	114,3	114,3	114,3	114,3	114,3
OD1 (partial recovery)	mm	76,1	76,1	76,1	76,1	76,1	76,1	76,1	76,1	76,1	76,1	76,1	76,1	76,1	76,1
OD2 (total recovery)	mm	114,3	114,3	114,3	114,3	114,3	114,3	139,7	114,3	114,3	114,3	114,3	114,3	114,3	139,7
A - Length	mm	4149	4149	4149	4149	4149	4149	4149	4149	4149	4149	4149	4149	4149	4149
B - Depth	mm	2243	2243	2243	2243	2243	2243	2243	2243	2243	2243	2243	2243	2243	2243
C - Height	mm	2668	2668	2668	2668	2668	2668	2668	2668	2668	2668	2668	2668	2668	2668
W1 Supporting point	kg	847	885	897	932	900	939	966	847	885	897	932	900	939	966
W2 Supporting point	kg	514	542	545	563	527	558	573	514	542	545	563	527	558	573
W3 Supporting point	kg	838	876	889	927	893	934	962	838	876	889	927	893	934	962
W4 Supporting point	kg	505	533	538	557	519	553	569	505	533	538	557	519	553	569
Shipping weight	kg	2594	2721	2754	2859	2721	2865	2948	2594	2721	2754	2859	2721	2865	2948
Operating weight	kg	2704	2836	2869	2979	2839	2984	3070	2704	2836	2869	2979	2839	2984	3070

Size		SC-EXC				SC-PRM			EN-EXC				EN-PRM		
		90.4	100.4	110.4	120.4	120.4	140.4	160.4	90.4	100.4	110.4	120.4	120.4	140.4	160.4
Container shipping length	mm	4300	4300	4300	4300	4300	4300	4300	4300	4300	4300	4300	4300	4300	4300
Container shipping depth	mm	2315	2315	2315	2315	2315	2315	2315	2315	2315	2315	2315	2315	2315	2315

The presence of optional accessories may result in a substantial variation of the weights shown in the table. Fan diffusers are separately supplied.



## Size 140.4-180.4 - EXCELLENCE version - Size 180.4-200.4 - PREMIUM version

### Acoustic configuration : Compressor soundproofing (SC) / Super-silenced (EN)

DAB8T140 4\_180 4\_EXC\_PRM\_SC\_EN\_2  
Data / Date: 02/08/2016

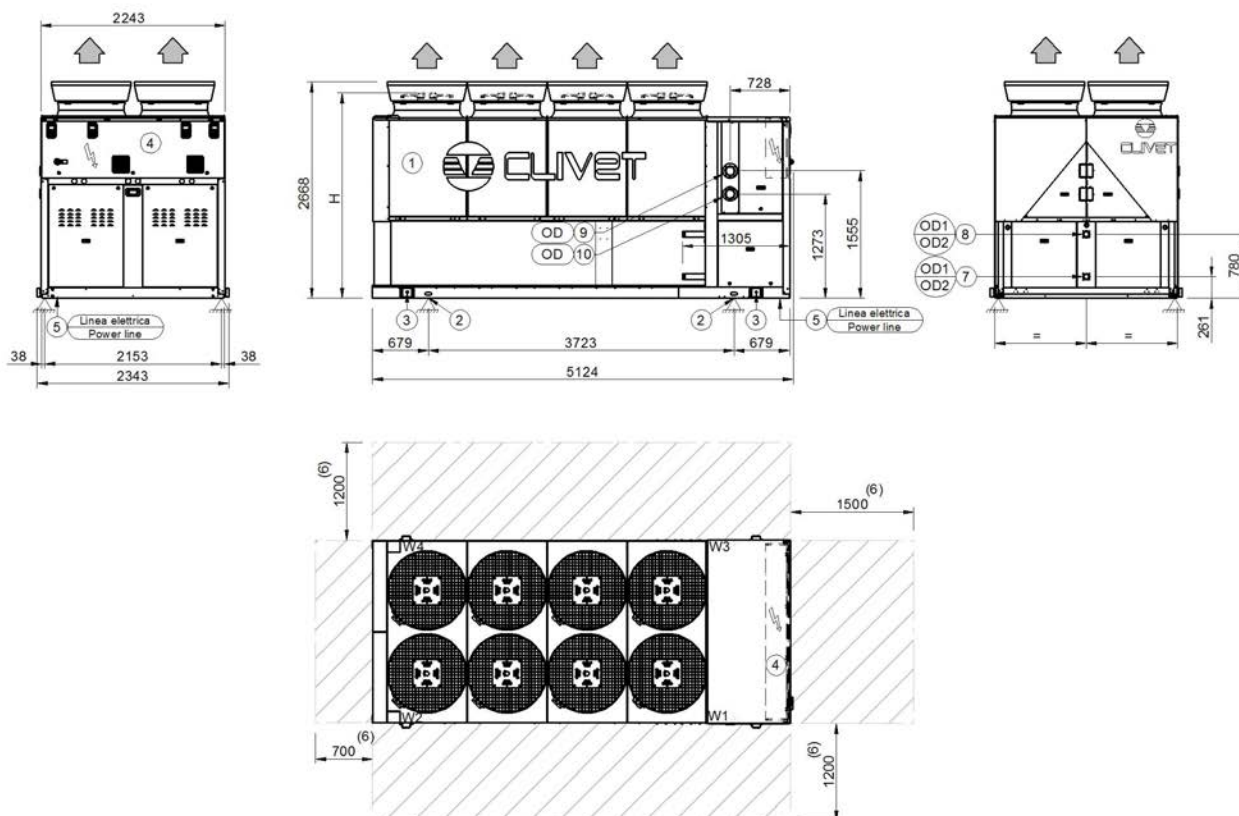

1. External exchanger (condenser)
2. Antivibration fixing holes  $\varnothing$  25mm
3. Lifting brackets (removable, if required, after positioning the unit)
4. General electrical panel
5. Power input
6. Suggested clearance
7. Recovery side exchanger water inlet (optional)
8. Recovery side exchanger water outlet (optional)
9. Water inlet user side of no pumps unit / Water outlet user side of unit with pumps (optional)
10. Water outlet user side of no pumps unit / Water inlet user side of unit with pumps (optional)

Size		SC-EXC			SC-PRM			EN-EXC			EN-PRM	
		140.4	160.4	180.4	180.4	200.4	140.4	160.4	180.4	180.4	200.4	
H (without Axitop)	mm	2484	2484	2484	2484	2484	2484	2484	2484	2484	2484	
H (without Axitop with ECOBREEZE - optional)	mm	2510	2510	2510	2510	2510	2510	2510	2510	2510	2510	
OD (internal exchanger)	mm	114,3	114,3	114,3	114,3	139,7	114,3	114,3	114,3	114,3	139,7	
OD1 (partial recovery)	mm	76,1	76,1	76,1	76,1	76,1	76,1	76,1	76,1	76,1	76,1	
OD2 (total recovery)	mm	114,3	139,7	139,7	139,7	139,7	114,3	139,7	139,7	139,7	139,7	
A - Length	mm	5124	5124	5124	5124	5124	5124	5124	5124	5124	5124	
B - Depth	mm	2243	2243	2243	2243	2243	2243	2243	2243	2243	2243	
C - Height	mm	2668	2668	2668	2668	2668	2668	2668	2668	2668	2668	
W1 Supporting point	kg	1053	1083	1206	1139	1177	1053	1083	1206	1139	1177	
W2 Supporting point	kg	672	690	748	673	704	672	690	748	673	704	
W3 Supporting point	kg	1042	1074	1202	1132	1173	1042	1074	1202	1132	1173	
W4 Supporting point	kg	661	681	743	665	700	661	681	743	665	700	
Shipping weight	kg	3274	3371	3737	3453	3593	3274	3371	3737	3453	3593	
Operating weight	kg	3428	3528	3899	3609	3754	3428	3528	3899	3609	3754	

Size		SC-EXC			SC-PRM			EN-EXC			EN-PRM	
		140.4	160.4	180.4	180.4	200.4	140.4	160.4	180.4	180.4	200.4	
Container shipping length	mm	5275	5275	5275	5275	5275	5275	5275	5275	5275	5275	
Container shipping depth	mm	2315	2315	2315	2315	2315	2315	2315	2315	2315	2315	

The presence of optional accessories may result in a substantial variation of the weights shown in the table. Fan diffusers are separately supplied.

## Size 200.4-240.4 - EXCELLENCE version - Size 220.4-240.4 - PREMIUM version

### Acoustic configuration : Compressor soundproofing (SC) / Super-silenced (EN)

DAB8T200 4\_240 4\_EXC\_PRM\_SC\_EN\_1  
Data/Date 04/08/2016

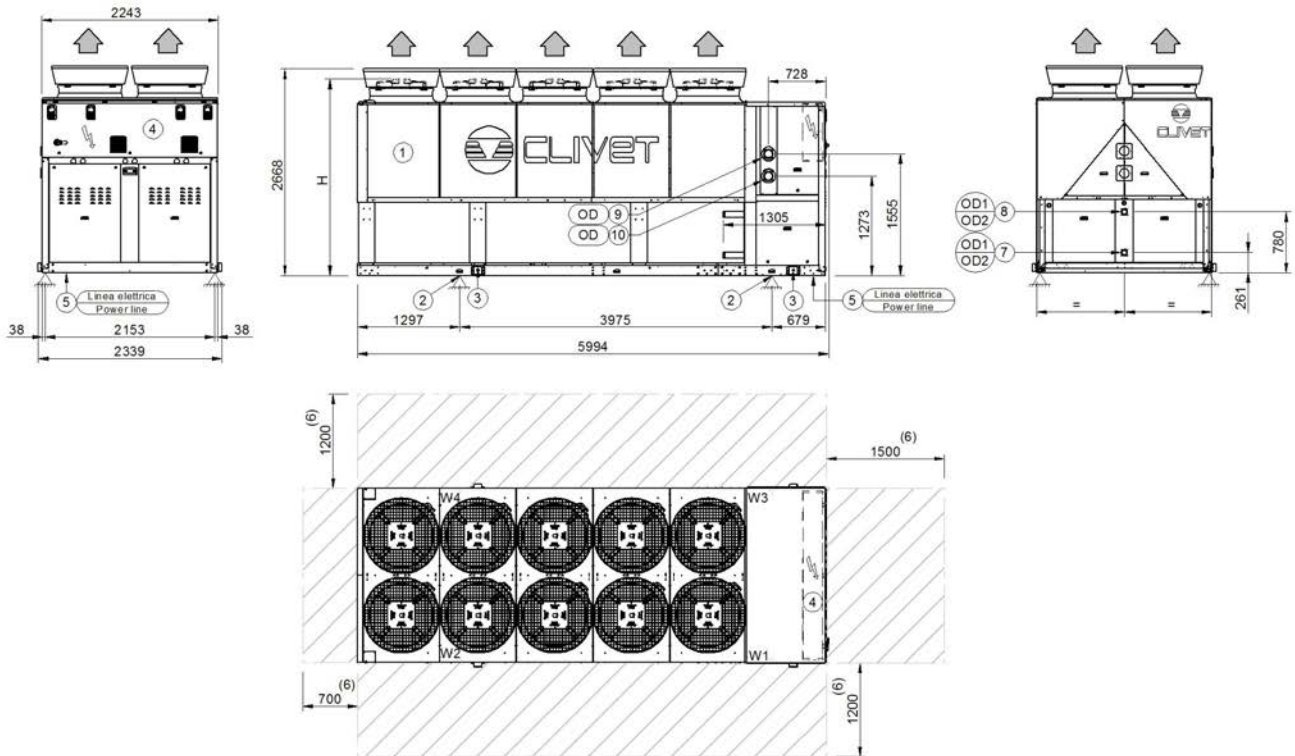

1. External exchanger (condenser)
2. Antivibration fixing holes  $\varnothing$  25mm
3. Lifting brackets (removable, if required, after positioning the unit)
4. General electrical panel
5. Power input
6. Suggested clearance
7. Recovery side exchanger water inlet (optional)
8. Recovery side exchanger water outlet (optional)
9. Water inlet user side of no pumps unit / Water outlet user side of unit with pumps (optional)
10. Water outlet user side of no pumps unit / Water inlet user side of unit with pumps (optional)

Size		SC-EXC			SC-PRM		EN-EXC			EN-PRM	
		200.4	220.4	240.4	220.4	240.4	200.4	220.4	240.4	220.4	240.4
H (without Axitop)	mm	2484	2484	2484	2484	2484	2484	2484	2484	2484	2484
H (without Axitop with ECOBREEZE - optional)	mm	2510	2510	2510	2510	2510	2510	2510	2510	2510	2510
OD (internal exchanger)	mm	139,7	139,7	139,7	139,7	139,7	139,7	139,7	139,7	139,7	139,7
OD1 (partial recovery)	mm	76,1	76,1	76,1	76,1	76,1	76,1	76,1	76,1	76,1	76,1
OD2 (total recovery)	mm	139,7	139,7	139,7	139,7	139,7	139,7	139,7	139,7	139,7	139,7
A - Length	mm	5994	5994	5994	5994	5994	5994	5994	5994	5994	5994
B - Depth	mm	2243	2243	2243	2243	2243	2243	2243	2243	2243	2243
C - Height	mm	2668	2668	2668	2668	2668	2668	2668	2668	2668	2668
W1 Supporting point	kg	1331	1366	1414	1310	1376	1331	1366	1414	1310	1376
W2 Supporting point	kg	871	889	925	833	883	871	889	925	833	883
W3 Supporting point	kg	1321	1380	1413	1315	1372	1321	1380	1413	1315	1372
W4 Supporting point	kg	861	903	924	838	879	861	903	924	838	879
Shipping weight	kg	4185	4332	4468	4097	4305	4185	4332	4468	4097	4305
Operating weight	kg	4384	4538	4676	4296	4510	4384	4538	4676	4296	4510

Size		SC-EXC			SC-PRM		EN-EXC			EN-PRM	
		200.4	220.4	240.4	220.4	240.4	200.4	220.4	240.4	220.4	240.4
Container shipping length	mm	6145	6145	6145	6145	6145	6145	6145	6145	6145	6145
Container shipping depth	mm	2315	2315	2315	2315	2315	2315	2315	2315	2315	2315

The presence of optional accessories may result in a substantial variation of the weights shown in the table. Fan diffusers are separately supplied.

Page intentionally left blank

Page intentionally left blank

Page intentionally left blank

**CLIVET SPA**

Via Camp Lonc 25, Z.I. Villapaiera - 32032 Feltre (BL) - Italy  
Tel. + 39 0439 3131 - Fax + 39 0439 313300 - info@clivet.it

**CLIVET GROUP UK Limited**

Units F5&F6 Railway Triangle Ind Est, Walton Road - Portsmouth, Hampshire - PO6 1TG - United Kingdom  
Tel. + 44 (0) 1489 572238 - Fax. +44 (0) 2392 381243 - enquiries@clivetgroup.co.uk

**CLIVET ESPAÑA S.A.U.**

C/ Bac de Roda, 36 - 08019 Barcelona - España  
Tel: +34 93 8606248 - Fax +34 93 8855392 - info@clivet.es

Av.Manoteras Nº 38, Oficina C303 - 28050 Madrid - España  
Tel. +34 91 6658280 - Fax +34 91 6657806 - info@clivet.es

**CLIVET GmbH**

Hummelsbütteler Steindamm 84, 22851 Norderstedt - Germany  
Tel. + 49 (0) 40 32 59 57-0 - Fax + 49 (0) 40 32 59 57-194 - info.de@clivet.com

**CLIVET RUSSIA**

Elektrozavodskaya st. 24, office 509 - 107023, Moscow, Russia  
Tel. + 74956462009 - Fax + 74956462009 - info.ru@clivet.com

**CLIVET MIDEAST FZCO**

Dubai Silicon Oasis (DSO), High Bay Complex, Office N. 20, PO BOX 342009, Dubai, UAE  
Tel. + 9714 3208499 - Fax + 9714 3208216 - info@clivet.ae

**CLIVET AIRCONDITIONING SYSTEMS PRIVATE LIMITED**

501/502, Commercial-1, Kohinoor City, Old Premier Compound, Kirol Road, Off L B S Marg, Kurla West - Mumbai 400 070 - India  
Tel. +91 22 30930250 - info.in@clivet.com

---

[www.clivet.com](http://www.clivet.com)  
[www.clivetlive.com](http://www.clivetlive.com)

A Group Company of

