

SPINchiller³ Multifunction

Multifunction heat pump with hot/chilled simultaneous water production for outdoor installation

WSAN-XSC3 MF 90.4-240.4 RANGE

Nominal heating capacity from 296 kW to 731 kW
Nominal cooling capacity from 259 kW to 650 kW



- ▶ Axitop diffusers
- ▶ R-410A modular scroll technology
- ▶ Two independent refrigeration circuit
- ▶ Condensing heat free recovery

Configuration for 4-pipe system

- ▶ Up to 55°C hot water supplied

Configuration for 2-pipe system with total recovery



Clivet hydronic system

Designed to provide high energy efficiency and sustainability of the investment, the wide range of Clivet liquid chillers and heat pumps for high efficiency air conditioning of Residential and Commercial spaces and for Industrial applications it is available with air or water source.

HYDRONIC System - Air Source

	Small and Medium Commercial			Large Commercial and Industry		
	ELFOEnergy Extended Inverter ELFOEnergy Edge ELFOEnergy Duct Inverter	ELFOEnergy Medium / Large ELFOEnergy Vulcan Medium ELFOEnergy Duct Medium	ELFOEnergy Megaram	Remotes Multi Scroll Technology	SPINchiller ³ /SPINchiller ³ Duct Multi Scroll Technology	SCREWLine ³
Capacity (kW)	4 - 54 kW	28 - 236 kW	58 - 375 kW	737 - 2054 kW	175 - 1358 kW	867 - 1523 kW
EFOPindex (the lower the better)						
Product						
LifeCycle	WSAF-XM TBC PRM	WSAF-XE TBC PRM	WSAF-XM TBC PRM	WSAF-XSC3 TBC PRM	WSAF-XSC3 TBC PRM	WDM-SL3 WDM-TLS TBC PRM
High Temperature/Chiller Inverter Air	WSAF-EM TBC PRM			WDM-SL3 TBC PRM		
Free Cooling Units	WSAF-EM TBC PRM			WDM-SL3 TBC PRM		
Heat Output	WSAN-HN TBC PRM	WSAN-HE TBC PRM	WSAN-HN TBC PRM	MDF-XSC3 TBC PRM	WSAN-HSC3 TBC PRM	WDM-SL3 TBC PRM
High temperature water Refrigerant	WBN TBC PRM			WDM-SL3 TBC PRM		
Multi function Refrigerant	WSAN-HN M TBC PRM			WSAN-HSC3 MF TBC PRM		
Decorative	WSAN-HN TBC PRM	WSAN-HE TBC PRM	WSAN-HN TBC PRM	WSA-XSC3 TBC PRM		

Specialization

Every intended use has specific requirements which determine the overall efficiency. For this, the Clivet hydronic system always offers the best solution in every project.

- Modular range with over 8000 kW of overall capacity
- Capacity control with Screw and modular Scroll technology
- Multifunction versions
- Outdoor or indoor (ductable type) installation

Centrality of the Air Renewal

From the Air Renewal depends the comfort in the spaces. Since it often represents the main building energetic load, it also determines the running costs of the entire system.



ZEPHIR3
Packaged Primary Air supply system with thermodynamic energy recovery.

- Simplifies the system, reduces the heating and cooling generators
- Purifies the air with standard electronic filters
- Increases the energy efficiency and it also allows a savings of 40% on the running costs
- From -40°C to +50°C of outdoor air temperature

Terminal and AHU complete system

The hydronic terminal units are very diffused for their versatility and reliability. The Clivet range includes many versions that simplify the application in different type of installation and building.



ELFOspace
High energy efficiency hydronic terminal units

AQX
Air-conditioning unit

- Cased and uncased terminal units, from 1 to 90 kW
- Horizontal and vertical installation
- Energy-saving DC fans
- Modular air conditioning units up to 160.000 m³/h
- EUROVENT certification

SPINchiller³: modular scroll technology for every application

SPINchiller³ is the new generation of Clivet liquid chillers and heat pump with modular scroll technology. Thanks to its high seasonal efficiency and range versatility, it represents the ideal solution for different types of installation.

WSAT-XSC3

Air cooled water chiller

- EXCELLENCE high efficiency version and PREMIUM compact version
- Operating with 52°C of outdoor air temperature
- Total / partial recovery of the condensing heat
- Eurovent certification



Dedicated series separately documented

WSAT-XSC3 FREE-COOLING

Air cooled water chiller with FREE-COOLING

- Direct FREE-COOLING
- Indirect FREE-COOLING (No-Glycol)



Dedicated series separately documented

WSAN-XSC3

Air cooled heat pump

- EXCELLENCE high efficiency version
- Eurovent certification



Dedicated series separately documented

WSAN-XSC3 MULTIFUNCTION

Air cooled heat/cool heat pump with simultaneous operating

- EXCELLENCE high efficiency version
- 4-pipe system
- 2-pipe system and total condensing heat recovery



Index of contents

Features and benefits	5
Standard unit technical specifications	18
Unit equipment with outdoor air low temperatures	20
Configuration for 4-pipe system	21
Configuration for 2-pipe system	40
Hydronic assembly	61
Hydronic assembly - Accessories	66
Accessories	69
Accessories separately supplied	73
Option compatibility	74
Dimensional drawings	76

Cost or reliability?

The dilemma of modern system engineering applications

Air-conditioning systems in trade centres influence both the starting investment and monthly management costs, for the whole of their working lives. This theme is even more relevant in residential applications with centralised systems. Furthermore, maximum working flexibility requirements should be added to that, in serving different users while avoiding wasting energy and thus, money. Finally, there are several industrial applications which require hot or chilled water as service fluid, process fluid or vector fluid for operator comfort and for conserving goods and enabling cycles to function correctly. Furthermore, in all these cases, the working reliability of the system is decisive.



High efficiency hydronic systems

The high efficiency hydronic systems are extremely versatile, reliable and widespread

Despite their apparently low costs, split, multi-split and VRF direct expansion systems have a lot of limits in these applications. For example, they require a separate system for primary air treatment. The pipes that contain the refrigerant cross the served rooms and therefore they are subject to restrictions and use limitations. They cannot operate in the FREE-COOLING mode, the high efficiency and convenient mode that allows energy savings.

The hydronic systems are certainly more complete and versatile. They make it possible to adopt various types of terminals in the served environment, from fan coil units exposed or integrated in the furnishings, up to radiant or induction systems. They are also irreplaceable in the service and process industrial applications.

The main component performances, like air-cooled liquid chillers and hydronic heat pumps, are checked and certificated by appropriate certification programs, as Eurovent.



Clivet technological evolution

Clivet chillers reduce consumption and are compact and reliable

With over twenty years of technological evolution, Clivet liquid chillers and heat pumps represent the state of the art in air-conditioning of residential, trade and industrial environments.

Their success is based on high energy efficiency, compactness and management maintenance simplicity, with wide versatility in the choice of the most suitable model for the specific use.



Many applications require heating and cooling simultaneous production

Simultaneous opposite loads is a very frequent situation in many applications.

Large size buildings, aspect, variable insulation and different purpose ambient make recurring the request of heating and cooling simultaneously.

Many different technical solutions could be used at this purpose. Clivet believes since ever that solution differentiation is the key for success and consequently present diversified solutions for answering to only apparently similar demands



Traditional way

The solution very common in the past is the independent production of heating and cooling thermal energy and transferring them to different ambient.

Thermal energy production thanks to one or many boilers and cooling power production with chillers is one possible solution. Low efficiency of such kind system is well known, indeed during the periods where cooling and heating are simultaneously required, cooling energy production rejects a large quantity of thermal energy to a source and this is the working principle of a standard chiller, energy that could be used instead, supporting for example other thermal energy sources or as total replacement



Enhanced hydronic system

Clivet, since ever pioneer of innovative solutions proposes advanced hydronic system as optimal solution for 90% of applications where simultaneous opposite loads are present.

Building blocks are:

- SPINChiller heat pump
- Primary Energy decentralized system Zephir
- ELFOSpace fancoils



Thanks to a proper primary air design and using Clivet products around 30% annual energy saving is achievable and with a more competitive capital investment*.

MULTIFUNCTION Option

Hydronic multifunction units, able to produce hot water and chilled water simultaneously and independently is the optimal solution for some industrial applications or where the four pipe air conditioning system is required.

Heat pump product family called MULTIFUNCTION (MF) is the Clivet answer.

*Dedicated documented.

MULTIFUNCTION by CLIVET

ELFOEnergy MAGNUM and SPINChiller3 MF are the two air source heat pump families for simultaneous production of hot and chilled water for air conditioning.

Configuration available:

- **4T:** supply water for four pipe systems;
 - produce chilled water and hot water to the system simultaneously and independently during throughout the year.
- **2T:** supply water for two pipe air conditioning systems;
 - produce chilled water or hot water to the system depending on the season;
 - supply hot water using the total recovery device for domestic hot water tanks, pre or post heating simultaneously with chilled water production;

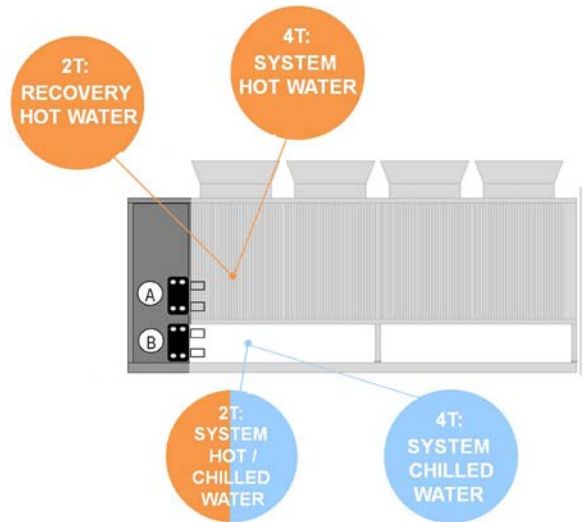

360° of efficiency

During a whole year and during the same day heating and cooling demand hugely vary with hot-cool combinations very unstable, function of many factors, among others: latitude and altitude of installation, building features and functionalities of different ambient.

Unit will mainly work in simultaneous heating-cooling mode with varying combinations over the time.

Clivet unit distinguishes for this working mode offering the best efficiency performance thanks to used solutions.

Refrigerant scheme allows both the partial and the total recovery mode for the MULTIFUNCTION heat exchanger according to thermal energy required.

Completely automatic set-up and system control logic adjusts the mode according the most efficient performance.

During a whole year more than half of energy provided is produced during unbalanced capacity demand where MULTIFUNCTION offer the best performances.

Using the heat exchanger as a partial recovery device drives to an higher efficiency of 5% compared to solutions not using this working mode.

Real benefits in terms of efficiency and reliability:

- Few mode switches, reset where thermal capacity is less than 25% of cooling capacity, thanks to the condensing heat recovery.
- Improved reliability thanks to a modulated operating and to a reduced number of switchings on the refrigeration circuit.
- Additional 3% savings on annual energy consumption comparing to standard multifunction units.

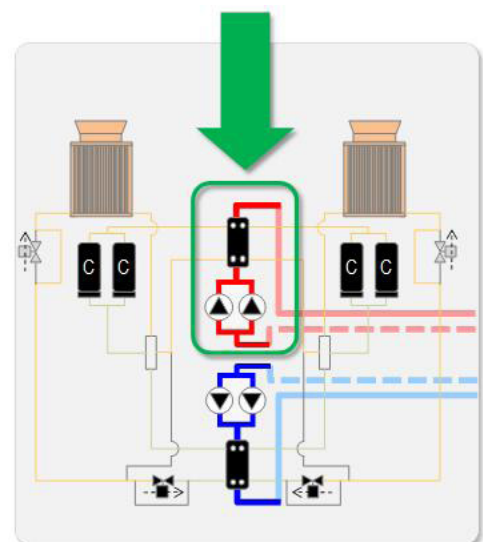
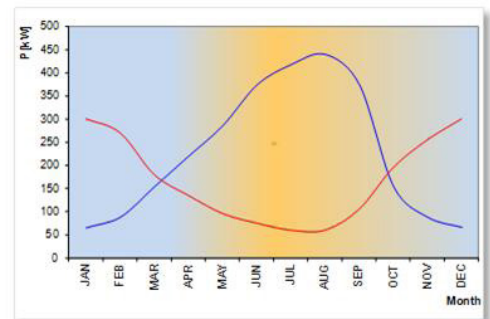

Comfort and energy saving in one solution

Maximum efficiency is necessary with a part load

The system is required to generate maximum capacity only for a short amount of time.

Therefore, it is essential to have the maximum efficiency under part-load conditions.

This is the only way to actually reduce overall yearly consumptions.

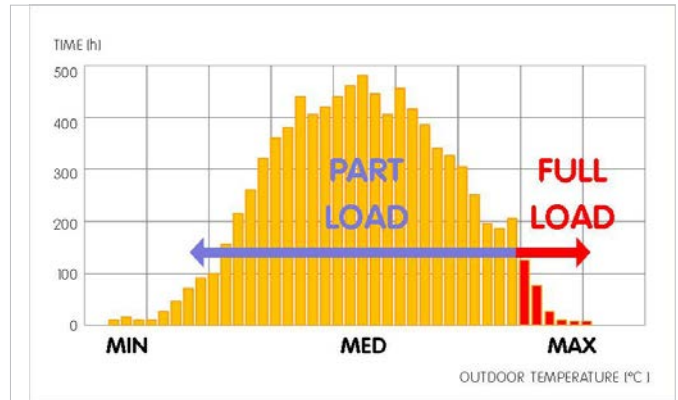

Part load efficiency determines the seasonal efficiency

Seasonal efficiency is conventionally represented by ESEER parameters according to Eurovent and IPLV parameters according to AHRI. Both give great importance to part load operation, since it is the predominant condition.

CARICO IMPIANTO	PESO (ESEER) *	PESO (IPLV) *
100%	3%	1%
75%	33%	42%
50%	41%	45%
25%	23%	12%

* EUROVENT (ESEER) supply times reference and AHRI (IPLV) reference for seasonal efficiency calculations.

SPINchiller technology enhances part-load efficiency

SPINchiller³ uses high efficiency Scroll compressors.

The advantages are:

- compressors manufactured in large ranges on an industrial scale with strict quality control inspections and maximum manufacturing reliability thanks to the high production volumes.
- every refrigeration circuit uses two or three Scroll compressors, depending on the different sizes of the unit. When two compressors are used, their sizes are different in order to obtain more control steps. This way, only the necessary energy is supplied.

Doubled efficiency

The heat exchange surface is sized for full capacity operation. Under part load condition, some compressors are automatically deactivated. Under this condition, in fact, the compressors in operation make use of a much larger surface.

This entails a reduced condensation temperature and an increased evaporation temperature. This way, the compressor capacity consumption is reduced with respect to the yield thereby increasing the overall efficiency of the unit.

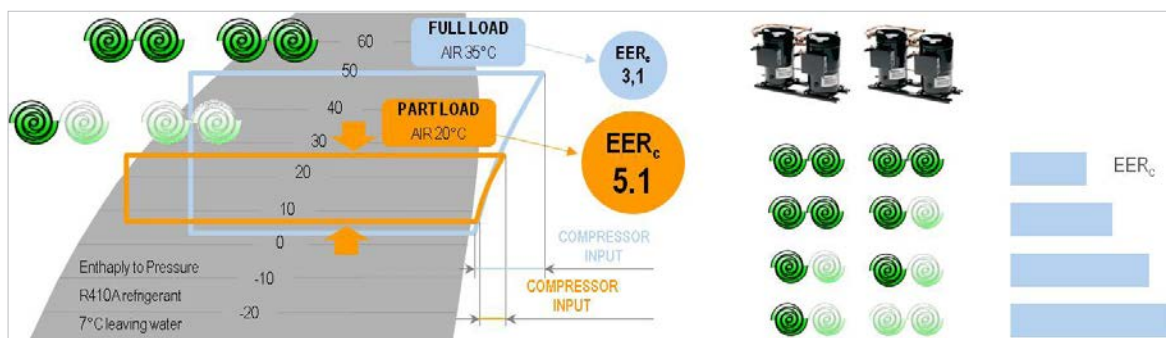

EER_c = Energy efficiency referred to compressors

Efficient and silent ventilation technology

Advanced aerofoil fans

The external axial fans are equipped with the innovative Winglet airfoil-vane with integrated baffle, able to increase the aerodynamic efficiency.

It results in a consumption reduction of the 10% and a medium sound emission lower of 6 dB than the traditional fans.

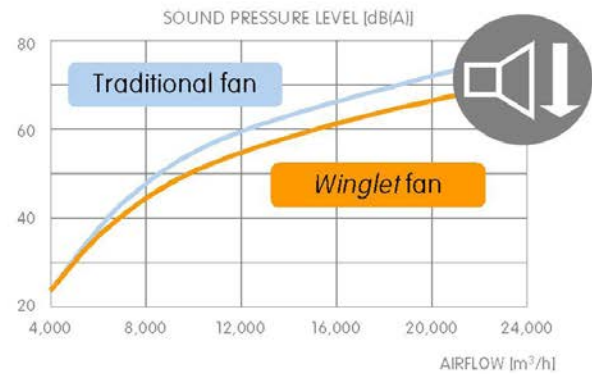
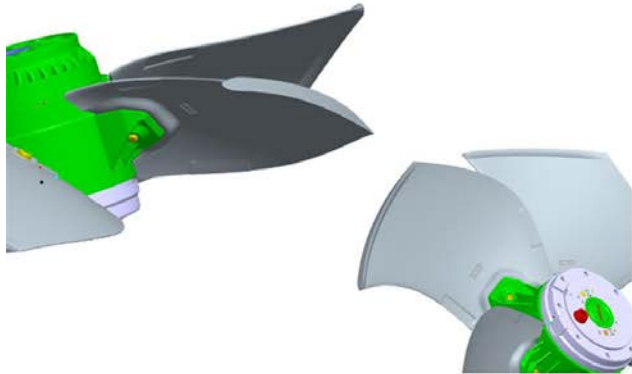

Diffusers for fans

Also the innovative air handling system on the external exchangers is the result of the Clivet design evolution. The new AxiTop diffuser creates an ideal air distribution: it aerodynamically decelerates the flow and transforms a big part of its dynamic energy in static pressure, obtaining:

- -3 dB of sound reduction
- reduction of 3% of the absorbed energy

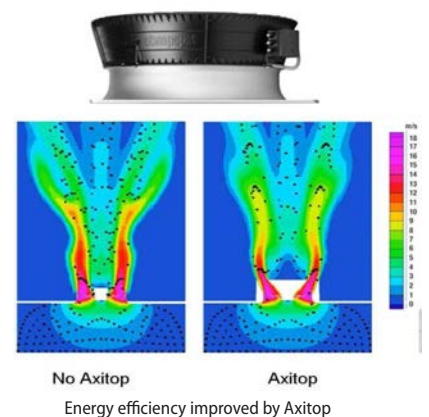

Fans at variable speed for minimal noise emission

All SPINchiller³ units are equipped with electronic condensation control. It automatically reduces the fan speed when the heat load is reduced. Since the fans are the unit's main noise source, the benefits are evident especially during the night hours, when the load is reduced but sensitivity to noise is enhanced. All this translates into a sound pressure reduced down to 8 dB(A) compared to full load operation in 90% of operating time of the unit.

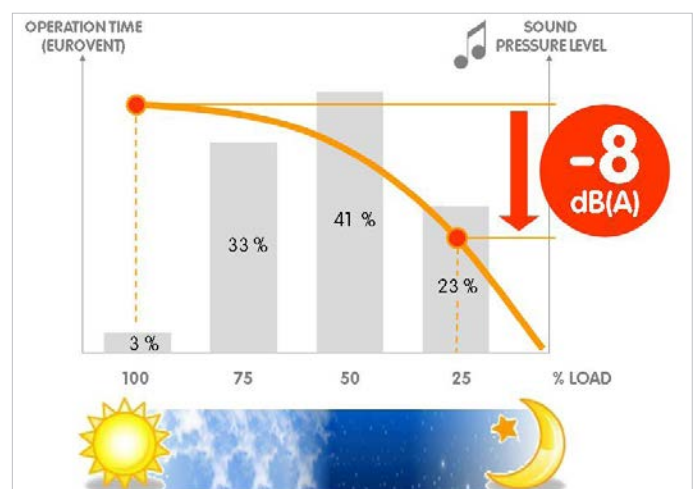

The best choice for every business

Excellence version: maximum efficiency

All SPINchiller³ models feature high part-load energy efficiency, which means high ESEER seasonal efficiency.

EXCELLENCE version it's the best match between capital cost and total lifecycle cost.

Apart from the high seasonal efficiency, the standard EXCELLENCE SC version stands out for its extremely high energy efficiency ratio (COP) during full-load heating, which reaches the value 3.7.

This is all possible thanks to Scroll modular technology, high efficiency heat exchangers and ECOBREEZE fans fitted with a permanent-magnet motor and an electronic control device supplied as standard.

This allows for:

- energy efficiencies equal to or higher than most units on the market equipped with screw compressors, even when inverter driven
- efficient use even in a large number of industrial and process applications
- upgrade of the building's energy class and, therefore, increased value
- maximum savings on running and maintenance costs.



Perfect for LEED certification

The whole EXCELLENCE SC range satisfies both requirements 2 (Minimum Energy Performance) and 3 (Fundamental Refrigerant Management) of Energy and Atmosphere section.

Clivet is committed in promoting the green building principles and has become a member of GBC Italia. This organization collaborates with USGBC, the U.S. nonprofit organization that promotes worldwide the LEED system of independent certification.



Superior flexibility and reliability

Efficient precision

Sequential activation of SPINchiller³ compressors allow:

- adapting to the load required for use, thereby ensuring added comfort
- reducing the number of compressor start-ups, i.e., the main cause of wear
- increasing the unit's useful life
- reducing repair times and costs, thanks to the modular components, their reduced dimensions and reduced cost compared to semi-hermetic compressors.

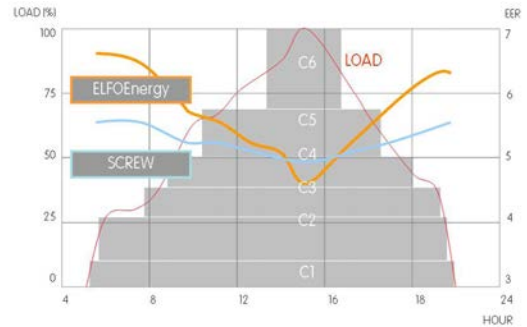

THE NUMBER OF START-UPS DECREASES THEREFORE THE LIFE CYCLE INCREASES

Stable and reliable operation

The electronic expansion valve (EEV) adapts rapidly and precisely to the actual load required for usage, allowing stable and reliable adjustment in comparison with mechanical thermostatic valves (TEV). This results also in a further increase in efficiency and longer compressor life.

The overheating control allows preventing phenomena that are hazardous to the compressors, such as overtemperature and return fluids, thereby increasing even more efficiency and durability.

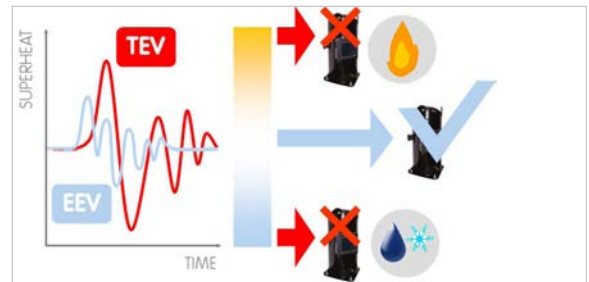

Simplified maintenance

Besides being efficient, SPINchiller³ improves the system maintenance. In fact, the malfunction of a compressor does not compromise overall operation. Furthermore, Scroll compressors are very compact, easy to find and easy to handle in case of replacement.



Controlled power supply

Proper power supply ensures optimal unit operation and protects its many electrical components.

The phase monitor, standard supplied.

- controls the presence and the exact sequence of the phases
- checks any voltage anomalies (-10%)
- automatically restarts the unit as soon as the proper power supply is restored.

The EXCELLENCE version is fitted with a multifunction monitor, where limit values and the service schedule of Clivet's Technical Support can be modified.



Advanced heat pump

Renewable energy heat pump technology

The electric Heat pump technology promotes and provides incentives by the European Union with specific standards, such as the EU Directive 2009/28/CE of April 23rd 2009 that recognises ambient heat as a renewable source.

Compared to a combustion system, the electric heat Pump allows:

- Energy saving and reduction of the CO2 emissions by an average of 50%
- Use of electric energy, increasingly produced through alternative and renewable sources
- Operation reliability and reduced maintenance
- No fossil combustion and therefore absence of chimney, absence of periodical controls on the emissions in the ambient and no local production of fine dust

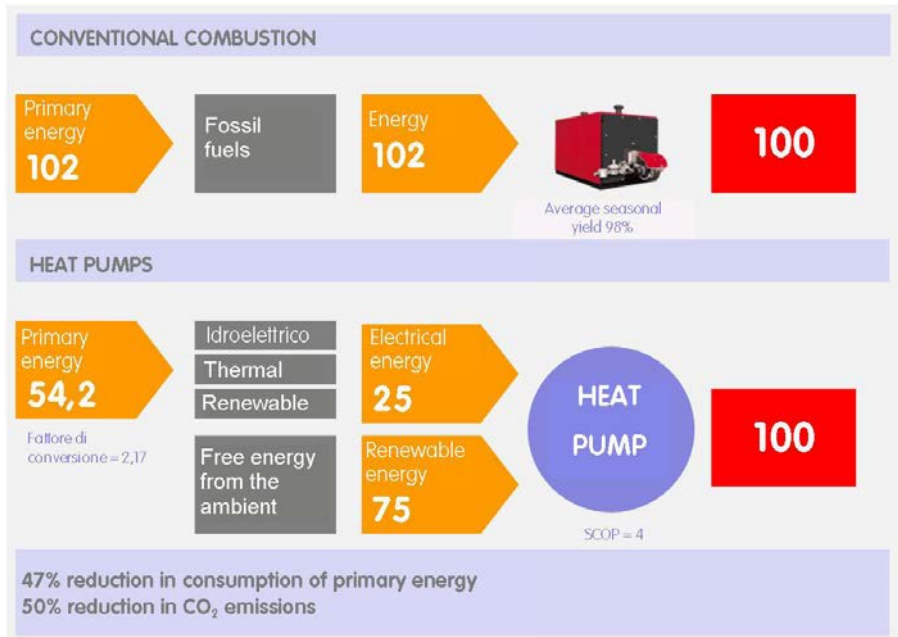

- Cost reduction of first investment with the reversible models that use a single system for both heating and cooling.

In heating mode, the reversible heat pump range by SPINchiller³ offers high efficiency in both full load operation and Partial load. The energy saving cycle operation throughout the year is noteworthy. Thanks to the brilliant half-load performance even when in cooling mode. This result was aided with precise technological choices and a long history of specialised experience.

Coils protected against the formation of ice

The particular technology of the heat pump developed by Clivet guarantees its continued and reliable operation.

The ICE PROTECTION SYSTEM device prevents icing on the base of the external exchanger during winter operation, thanks to a special subcooling circuit. This prevents damages caused by freezing.



Smart management of defrosts

The automatic defrost cycles on the remaining external exchanger surface are managed in predictive mode, reducing both the frequency and the duration. The electronics on board analyse not only the external conditions, but also the evaporation pressure variation in the exchanger.

The defrost cycles are activated one circuit at a time. In this way, the comfort and operation continuity are always ensured by at least one circuit.



High efficient refrigerant

R410A is the mix of two refrigerants used in equal parts: R32 that supplies the heating capacity and R125 that controls the flammability. It is a chlorine free refrigerant (HFC) with numerous advantages:

- ODP (Ozone Depletion Potential) = 0
- high volumetric effect thanks to the high coefficient global thermal exchange and to the pressure variation (glide) which is almost nil during the evaporation phase
- elevated density and efficiency, with greater compactness of the refrigeration circuit and therefore the responsible use of materials and small refrigerant quantity, for a reduced environmental impact.

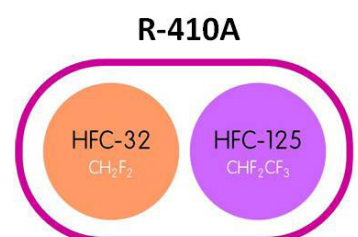

The automatic control device coordinates resources ensuring maximum efficiency

Operating completely automatic

The microprocessor control automatically manages operation according to the maximum efficiency criterion and includes many safety and alarm management functions.

It also includes advanced functions, such as daily and weekly programming and automatic maximum power consumption limitation (demand limit).

Versatility

The various supply temperatures that can be set make SPINchiller³ perfectly suitable for various types of systems, such as:

- heat dissipation on water loop systems
- distribution to terminal units, such as fan coils or other air treatment units
- distribution to radiant panels, induction terminals or cold beams.

Modularity

In the event of particularly large buildings requiring high capacities, it is advisable to use several units.

The SPINchiller³ units are designed to be connected in parallel in modular logic, thereby granting the following advantages:

Increased flexibility, enhanced by the control that can adapt to the load

Increased reliability, since the malfunction of one unit does not compromise the capacity supply of the other units.

Increased efficiency, since energy is produced where and when required, according to the served area.

The microprocessor control combined with ECOSHARE allows controlling up to 7 units in local network (1 Master unit and 6 Slave).

Remote system management

SPINchiller³ is standard equipped with:

- potential-free contact for remote on/off control
- potential-free contacts for remote display of the compressor status
- setting from user interface: Off / local On / serial On
- potential-free contact to remote any possible alarm

The various communication protocols allow the unit to exchange information with the main supervision systems by means of serial connections.

Energy measuring

Monitoring energy consumption and instant power employed is the starting point to improve the system's energy management and efficiency. With the optional energy meter, the user displays all the information related to the unit's electrical parameters on the interface built-in the unit or via the serial connection.

Moreover, the integration with the Demand Limit function supplied as standard allows to act on consumption levels by limiting them if they exceed the expected limit.



PERFECT FOR THE VARIOUS TYPES OF SYSTEMS



MODULAR SYSTEM THAT ENHANCES SPINchiller³ TECHNOLOGY ADVANTAGES

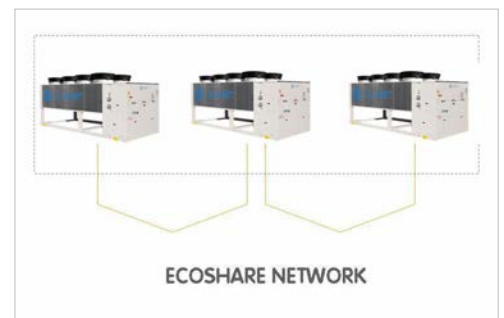

Seasonal energy efficiency is further increased with the DST operating logic

SPINchiller³ is standard provided with thermoregulation logic, named DST (Dynamic Supply Temperature).

In a constant water flow system, unlike the traditional control logic that aims at maintaining the water supply temperature constant, the DST logic aims at keeping constant the water return temperature, modifying the supply temperature dynamically according to the load. This way, evaporation temperature increases during part-load cooling, thereby increasing seasonal energy efficiency.

The DST control allows a considerable consumption and operation costs reduction, especially in civil applications, upon verification of the air treatment system's dehumidification capacity during cooling at part load.

The DST control allows considerable consumption and operation costs reduction, especially in civil applications, upon verification of the air treatment system's dehumidification capacity during part-load cooling. The DST control is particularly interesting when combined with active thermodynamic fresh air systems. The direct expansion circuit allows them to operate the outdoor air treatment independently from SPINchiller³, which can vary the system water supply temperature, thereby optimising energy efficiency in the yearly cycle.



Example

The following diagram represents the various operating temperatures in the production of chilled water under various load conditions for a typical civil system consisting of:

- secondary circuit with variable water flow-rate according to the load (linear variability for simplicity).

The traditional control logic keeps the water supply temperature to room terminals and outdoor air treatment units constant, in order for the latter to carry out the dehumidification.

The DST control logic, on the other hand, allows increasing the system water supply temperature during part-load operation, thereby increasing seasonal energy efficiency for SPINchiller³.

The DST application must be verified during the design stage according to specific system constraints.

Traditional control logic (system water flow rate temperature = constant)

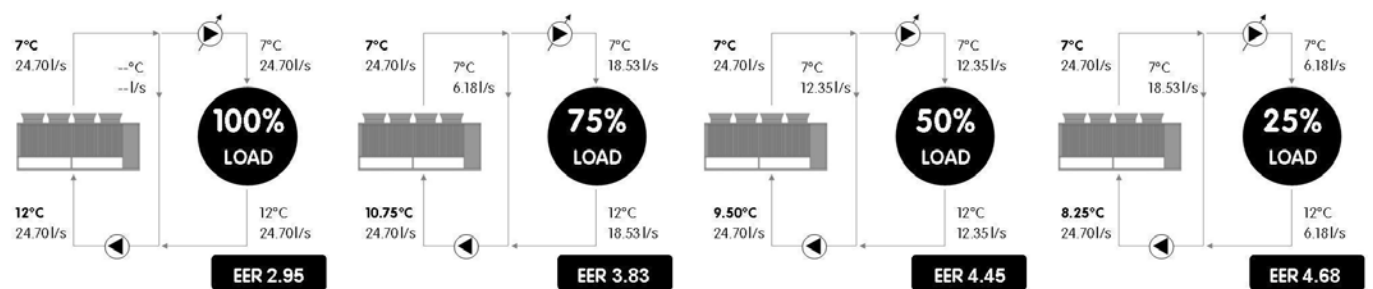

DST control logic (system water return temperature = constant)

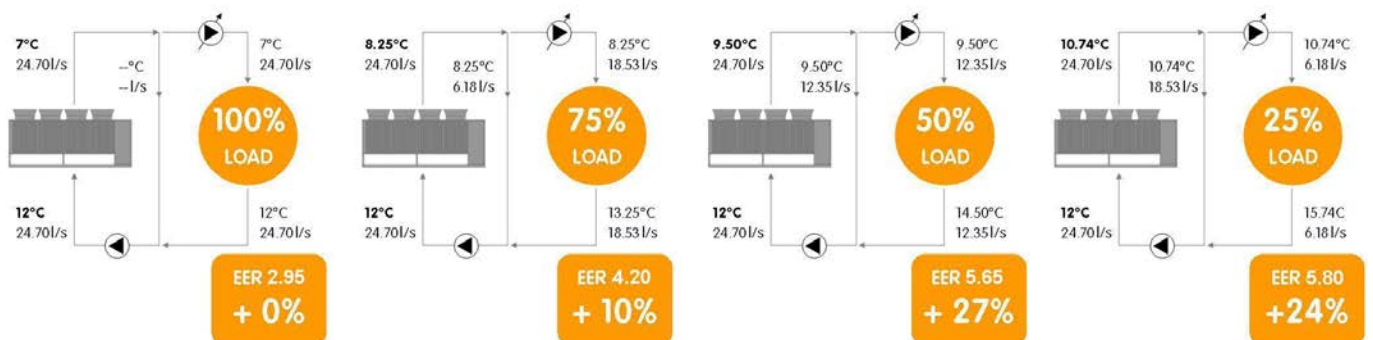

The control logic at variable flow rate

SPINchiller³ can also manage systems at variable water flow rate.

This control is made available setting the unit with built-in pumps at variable flow rate or, in case of external pumps at variable flow rate, through their direct management by the unit.

In a variable water flow rate system, in addition to the benefits of the control stability given by the control on the return temperature and by the energy saving in the part load operation, thanks to the pump flow rate reduction, is obtained a control aiming to maintain stable the temperature difference and consequently the water supply temperature.

Variable flow-rate advantages

Pumping energy for moving the water has an heavy impact on seasonal efficiency. The variable flow control is available for all MULTIFUNCTION units both on user side and recovery side, driving to energy savings during partial load. Pump energy consumption is proportional with cubic rotation speed. Evident the advantage when reducing flow-rate of 40% comparing to nominal conditions: energy saving is of 75% on pump energy consumption. The control logic is based on keeping stable the water temperature entering and leaving difference, guaranteeing at the same time the best efficiency and a working envelope within an acceptable range for the heat exchanger (pressure losses).

The control logic applies to both flow-rate and compressor regulation thanks to steps. Proportional-Integral-Derivative guarantees a precise and stable operation. The possibility of independent pump management in case of failure is embedded in the unit keeping operative the system.

In the multifunction units, the control at variable flow rate is available both on cold user side and on recovery side.

SPINchiller³ technology industrialised the system

SPINchiller³ can be supplied equipped with components that are often provided separately. This allows reducing:

- design times: all accessories are made to ensure the best overall efficiency;
- installation costs: the accessories already mechanically connected, electrically wired and individually tested are ready to be put to operate immediately;
- overall dimensions: system components are integrated with the unit, thereby reducing the technical area and increasing the area available for other uses.

Built-in inertial accumulation available

In the event of hydraulic distribution networks with reduced dimensions, it is important to provide the system with a hydraulic flywheel. In such cases, inertial accumulation is available built-in, equipped with insulating coating and all the necessary safety devices. This allows eliminating installation times and costs and freeing space inside the building.

The inertial accumulation is available connected to the hydraulic circuit hot user side or to the hydraulic circuit cold user side.

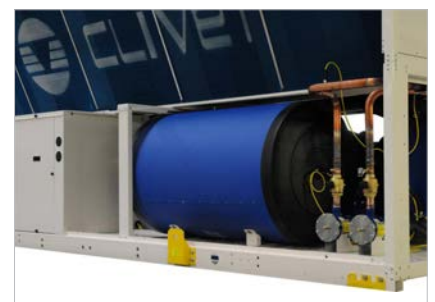

The built-in pumps are versatile, ready-for-use and reliable

The various solutions available are:

- HYDROPACK, the modular solution with two or three parallel pumps. Automatically reduces the water flow rate when in critical conditions, thereby preventing jams due to overloading, requiring the subsequent intervention of specialised technical personnel.
- it is very useful during start-ups, when restarting after operating breaks (e.g. at the weekend) or after a long period of inactivity.
- Inverter driven HYDROPACK allows water flow-rate-head calibration

Switching on and off of pumps externally installed is handled by the MULTIFUNCTION controller. Availability and operation of pumps has to be guaranteed in every working condition.

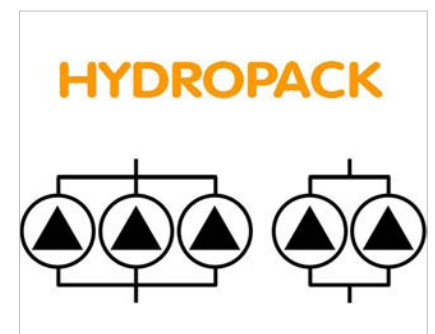

The exceptional HydroPack operation continuity

Due to its modularity, HYDROPACK maintains good water flow in the system even in the event of one of the pumps being temporarily unavailable.

In fact, with a deactivated pump, the residual flow is:

- about 80% of the rated flow (3 ON/OFF pump configuration)
- about 60% of the rated flow (2 ON/OFF pump configuration)

If variable flow-rate control is selected, failure of a pump is balanced by inverter, calibrating flow-rate on remaining pumps.

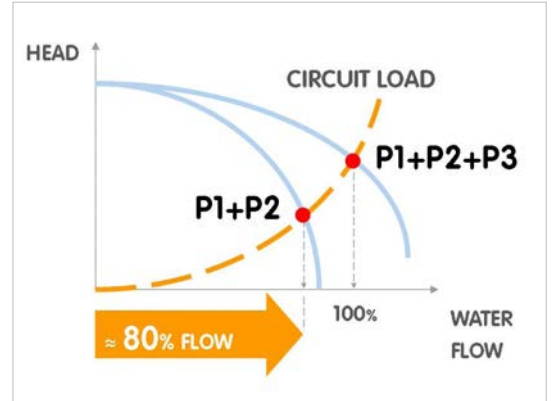

Produces hot water freely

The MULTIFUNCTION both in the 2-pipe and 4-pipe system configuration is standard equipped with an exchanger which can operate the condensation heat recovery up to:

- 100% of the available heat

When the heat request is simultaneous to the request of chilled water, the thermal energy, otherwise dissipated in the environment, is recovered to produce free hot water for:

- hot water coil supply for reheat
- domestic hot water production (with intermediate exchanger)
- other processes or operations

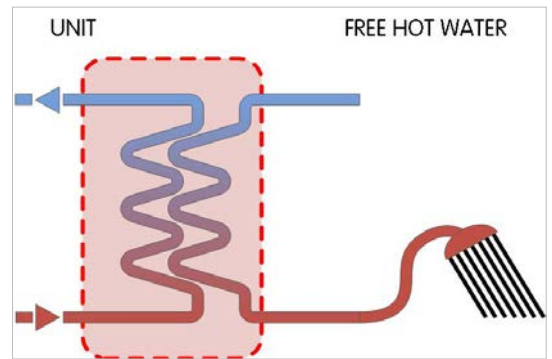

Further considerations on the application

The vast operating field of SPINchiller³ allows it to adapt to most system applications. In some cases, special duty conditions may exceed the unit operating field. Simple devices on the system allow proper operation and meeting any requirement. Here are two examples.

Water flow rate values outside the limits

SPINchiller³ operates with constant water flow rate to the evaporator, between a minimum and maximum value indicated in the technical documents.

Flow rate values below the limit may cause unwanted formation of ice, incrustations, reduced control precision, and the unit to stop following the intervention of built-in safety devices.

Flow values above the limit may cause high pressure drops, high pumping costs, and reduced control precision, and erosion damages to the exchangers.

In this example, the required flow-rate is lower than the maximum value allowed to the evaporator, while the operating temperatures fall within the functional field of the unit.

A properly sized bypass piping resolves the problem.

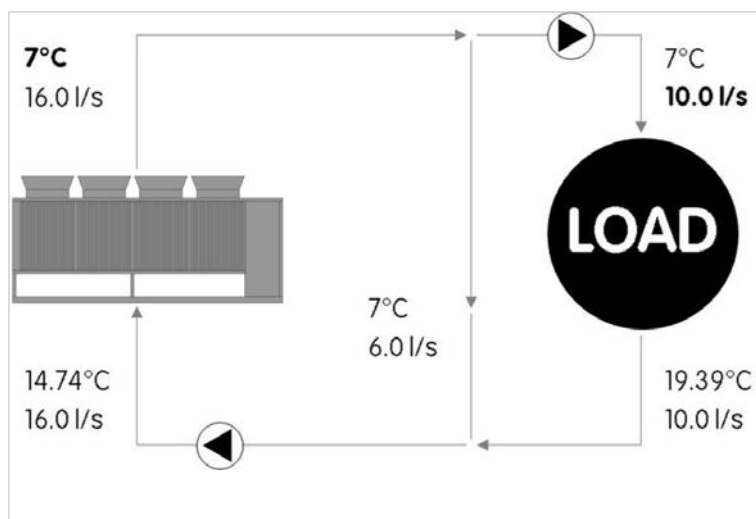

Example referred to W SAN-XSC3 MF 200.4 SC EXCELLENCE version.
Appropriate water flow rate for the correct unit operation.

Temperature values outside the limits

SPINchiller³ operates with the system supply temperatures indicated in the technical documentation.

Temperature limits below the limit may cause unwanted formation of ice and the unit to stop following the intervention of built-in safety devices.

Temperature values under the limit may cause malfunctions and damages to the compressors, reduced control precision, and the unit to stop following the intervention of built-in safety devices.

In this example, the required temperature exceeds the maximum value allowed to the evaporator, while the water flow rate falls within the functional field of the unit.

A properly sized bypass piping and mixing system resolve the problem.

Should both the water flow rate and the operating temperature exceed the values intended for the chiller, all you have to do is combine the two cases described above.

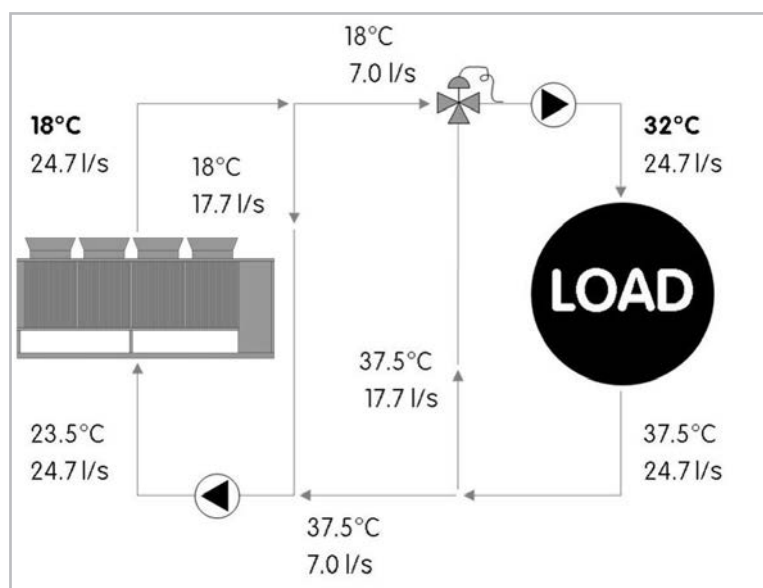

Example referred to W SAN-XSC3 MF 200.4 SC EXCELLENCE version.
Appropriate supply water temperature for the correct unit operation. Nominal water flow rate.

Exchanger thermal gradient

SPINchiller³ nominal capacities refer to internal exchanger thermal gradient equal to 5 °C. A different thermal gradient may be used in full load operation, provided that both the operating flow and temperatures fall within the limits. As an indication, this corresponds to a minimum thermal gradient of approximately 3 °C and a maximum of 10 °C (the exact values must be determined based on the allowed flows and temperatures).

Units connected in parallel

In systems with multiple units connected in hydraulic parallel, it is necessary to provide for a unit coordination system. Clivet proposes the Ecoshare system that offers many advantages:

- Greater energy efficiency.
- Higher redundancy.
- Higher reliability and flexibility.

Alternatively can be used the supervision system of the central station with insertion in cascade of the units or of the set-point shared on the different units.

Standard unit technical specifications

Compressor

Hermetic orbiting scroll compressor complete with motor over-temperature and over-current devices and protection against excessive gas discharge temperature. Fitted on rubber antivibration mounts and complete with oil charge. An oil heater, which starts automatically, keeps the oil from being diluted by the refrigerant when the compressor stops. The compressors are connected in TANDEM, on a single refrigeration circuit. They have a biphasic oil equalisation and are equipped with supply cutoff valves.

Structure

Sheet steel structure made with zinc-magnesium superficial treatment that guarantees excellent mechanical characteristics and high corrosion strength over time. Zinc-Magnesium base painted with polyester powder RAL 9001.

Panelling

External sheet steel panelling with pre-painted zinc-magnesium superficial treatment that ensures superior resistance to corrosion for outdoor installation and eliminates the need for periodical painting. The panels can be easily removed to fully access internal components and are lined with sound-proof material on the inside to contain the unit's sound levels.

Cold user side (4T) / user side (2T) exchanger

Direct expansion heat exchanger with braze welded stainless steel INOX AISI 316 plates and complete with external thermal/anti-condensation insulation.

The exchanger is complete with:

- differential pressure switch, water side
- antifreeze heater to protect the water side exchanger, preventing the formation of frost if the water temperature falls below a set value.

Hot user side (4T) / recovery (2T) exchanger

Direct expansion heat exchanger with braze welded stainless steel INOX AISI 316 plates with a large exchange surface. The exchanger is complete with:

- differential pressure switch, water side
- antifreeze heater to protect the water side exchanger, preventing the formation of frost if the water temperature falls below a set value.

External exchanger

Finned exchanger, made from copper pipes arranged in staggered rows and mechanically expanded for better adherence to the collar of the fins. The fins are made from aluminium with a special corrugated surface, set a suitable distance apart to ensure maximum heat exchange efficiency.

A correct power supply to the expansion valve is ensured by the subcooling circuit; this circuit also prevents the formation of ice at the base of the heat exchanger during winter operation.

Protective coverings available on request.

Fan

Axial fans with high performance and low-noise, balanced statically and dynamically, with blades in aluminum sheet coated in PP and sickle profile terminating with "Winglets", Wall ring in sheet steel pre-galvanised, directly coupled to the three-phase electric motor with external rotor and IP54 protection and class F insulation. Fans are housed in aerodynamically shaped structures, equipped with accident prevention guards.

Diffusers for external section fans - Axitop

Axitop diffusers, to be installed on the outdoor section fans, to recover dynamic energy, resulting in increased efficiency and minimal sound emission. It creates an ideal air distribution: it aerodynamically decelerates the flow and transforms a big part of its dynamic energy in static pressure. The Axitop diffuser installation is provided by the Customer.

External section fan consumption reduction device at variable speed (phase-cutting)

Automatic device for reducing of the outdoor section consumption with variable speed fans. The speed of the fan motors is continuously adjusted according to the condensing pressure to ensure the right working of the unit at low outside temperatures.

Refrigeration circuit

Refrigeration circuit with:

- replaceable anti-acid solid cartridge dehydrator filter;
- sight glass with moisture and liquid indicator;
- liquid receiver;
- electronic expansion valve;
- no-return valve;
- 4-way reversing valve;
- high pressure safety pressure switch;
- high pressure safety switch;
- low pressure safety switch;
- cutoff valve on liquid line;
- cut-off valve on compressor supply;
- suction liquid separator.

Configurations

4T - Configuration for 4-pipe system

2T - Configuration for 2-pipe system with total recovery

SC - Acoustic configuration with compressor soundproofing

EN - Super-silenced acoustic configuration

Electrical panel

The capacity section includes:

- main door lock isolator switch;
- main power supply terminals (400V/3Ph/50Hz);
- isolating transformer for auxiliary circuit power supply (230V/24V);
- compressor circuit breakers;
- fan overload circuit breakers;
- compressor control contactor.

The control section includes:

- interface terminal with graphic display;
- display of the set values, the error codes and the parameter index;
- ON/OFF and alarm reset buttons;
- proportional-integral-derivative water temperature control;
- daily, weekly programmer of temperature set-point and unit on/off;
- unit switching on management by local or remote;
- antifreeze protection water side;
- compressor overload protection and timer;
- prealarm function for water anti-ice and high refrigerant gas pressure;
- self-diagnosis system with immediate display of the error code;
- automatic compressor start rotation control;
- compressor operating hour display;
- remote ON/OFF control;
- remote HEAT/COOL control;
- relay for remote cumulative fault signal;
- input for demand limit (power input limitation according to a 0÷10V or 4÷20 mA external signal);
- digital input for double set-point enabling;
- potential-free contacts for compressor status;
- multifunction phase monitor;
- electrical panel ventilation.

Accessories - Hydronic assembly

- HYDROPACK ON/OFF cold user side (4T) or user side (2T) - n.b.: other types are available by head
- Inverter driven HYDROPACK for cold user side (4T) or user side (2T)
- Inverter driven HYDROPACK for hot user side (4T) or recovery side (2T)
- Storage tank - n.b.: it is available only one storage tank connected or to cold user side (4T) or to hot user side (4T). For 2T configuration the storage tank is available connected to user side.
- Steel mesh mechanical strainer (accessory separately provided). Note: To be located at the exchanger inlet. We disclaim any liability and make the guarantee void, if an appropriate mechanical filter is not provided inside the system.

Accessories

- Finned coil protection grilles
- Anti-hail protection grilles
- Copper / aluminium condenser coil with acrylic lining
- Copper / aluminium condenser coil with Energy Guard DCC Aluminium
- High and low pressure gauges
- Cutoff valve on compressor supply and return
- Couple of manual shut-off valves (accessory provided separately)
- Electrical panel antifreeze protection
- Power factor correction capacitors (cosφ > 0.9)
- ECOSHARE function for the automatic management of a group of units
- Disposal for inrush current reduction (SOFT STARTER)
- Device for fan consumption reduction of the external section, ECOBREEZE type
- Serial communication module for BACnet-IP supervisor
- Serial communication module for Modbus supervisor
- Serial communication module for LonWorks supervisor
- Remote control via microprocessor control (accessory separately supplied)
- Mains power supply (accessory separately supplied)
- Energy meter
- Set-point compensation with 0-10 V signal
- Set-point compensation with outdoor air temperature probe
- Limit extension kit in heating up to -10°C (W.B.)
- Spring antivibration mounts (supplied separately)
- Leak detector
- Variable flow-rate control

On special request are available:

- copper /copper condenser coil with brass shoulders

Test

Unit subjected to factory-tested in specific steps and test pressure of the piping of the refrigerant circuit (with nitrogen and hydrogen), before shipping them. After the approval, the moisture contents present in all circuits are analyzed, in order to ensure the respect of the limits set by the manufacturers of the different components.

Unit equipment with outdoor air low temperatures

Minimum outdoor air temperature		Operating unit		Unit in stand-by ⁽⁵⁾ (fed unit)	Unit in storage (unit not fed)
		Cool*	Heat**		
+11°C	1	√ standard unit	√ standard unit	√ standard unit	√ standard unit ⁽⁶⁾
+2°C	2				
-5°C	4				
-7°C	3				
-10°C	4	√ device for extended operating range			
Between -10°C and -15°C		NOT POSSIBLE	√ electrical panel antifreeze protection √ device for extended operating range √ glycol in an appropriate percentage	√ water empty unit or with an appropriate glycol percentage	
Between -15°C and -18°C			√ electrical panel anti freeze protection		
Between -18°C and -25°C		NOT POSSIBLE	NOT POSSIBLE	√ water empty unit or with an appropriate glycol percentage √ electrical panel anti-freeze protection	√ standard unit ⁽⁶⁾ Not suitable: X electrical panel anti-freeze protection X energy meter (CONTA2) X high and low pressure gauges (MHP)
Between -25°C and -39°C				X not suitable: recovery pumps	NOT POSSIBLE

Data referred to the following conditions:

- *chilled water production only:
internal exchanger water = 12/7 °C
- **hot water production only:
internal exchanger water = 40/45 °C

1. Part load unit and air speed equal to 1 m/s.
2. Part load unit and air speed equal to 0.5 m/s.
3. Part load unit and outdoor air temperature at rest.
4. Full load unit and outdoor air temperature at rest.

⁽³⁾ The water pumping unit must be fed and connected to the unit according to the manual.

⁽⁶⁾ Unit without water or containing water with an appropriate quantity of glycol.

At the unit start-up the water temperature or water with glycol must be inside the operating range indicated in the "Operating range" graph.

To know the water freezing temperature on varying the glycol percentage refer to the specific 'Correction factors for glycol use' table.



Air conditions which are at rest are defined as the absence of air flowing towards the unit. Weak winds can induce air to flow through the exchanger and air-levels which can cause a reduction in the operating range. In the presence of predominant winds it is necessary to use suitable windbreak barriers.



The unit, with an outdoor air temperature on average lower than -10°C, can remain stored for a maximum of 1 month.

4T configuration - For 4-pipe systems

4T configuration supply air conditioning systems with 4 tubes and it is able to supply hot water and chilled water simultaneously and independently on season.

This configuration allows:

- Simultaneous hot water production to the hot user side with chilled water production to the cold user side;
- Hot water production to the hot user side with cooling capacity rejection to the external thermal source;
- Chilled water production to the cold user side with heating capacity rejection to the external thermal source.

Unit controller guarantees unit operation in mix mode conditions.

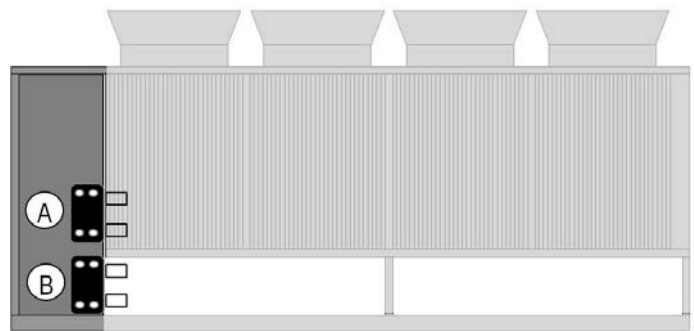

A: cold user side exchanger
B: hot user side exchanger

Considerations on the installation

Primary-secondary

The system must necessarily be provided with a hydraulic separator for primary-secondary both for the hot user side and for the cold user side. This allows the unit to effectively fulfil the load avoiding hysteresis of thermal shift. To monitor the secondary circuit load demand, it is necessary to keep operating the primary circuit pump periodically, hot and cold user side.

Suspension of hot load production

It is possible to inhibit the hot water production on hot user side and consequently the operation of the pumping unit connected to it through the appropriate potential free contact present in the electrical panel.

Desuperheater mode

The unit control, at part load, changes the water flow-rate, hot side, maintaining the temperature at the set-point. Through the flow modulation, the unit can produce hot water even over the set-point, up to a settable limit temperature (default 65°C). Thanks to this setting the exchanger operation time, hot user side, is extended in desuperheater mode, improving the unit efficiency of 5%.



The logic of control above described drives to a proper design of hydraulic components and safety devices, considering the upper limit of hot water. It is possible to decrease this temperature down to the set point, not having the energy efficiency benefits that desuperheater solution leads.

Operation with low water temperatures, hot user side

Depending on the outside air temperature, the hot user side set-point is automatically increased, by the unit control, to the minimum operation temperature indicated in the graph.

It is possible to maintain a hot user side temperature under the minimum limit indicated in the graph providing a primary-secondary. The secondary will be maintained at the desired temperature, the primary, managed by the unit, will have temperatures congruent to limits indicated in the graph..

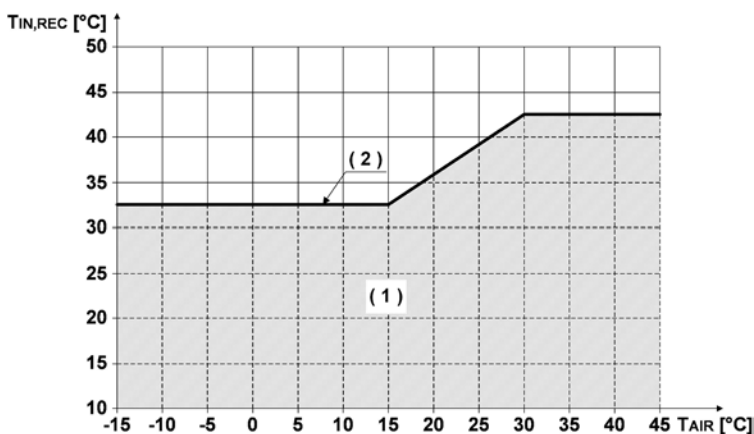

$T_{IN,REC}$ [°C] = entering water temperature to recovery
 T_{AIR} [°C] = entering external exchanger air temperature (D.B.)

1. Temporary operating range where unit forces the recovery set-point (if the hot load production is enabled)
2. Minimum system water temperature level, hot user side

Hot side water flow-rate

If the pumping unit hot user side is not built-in installed, **the external pump start signal must be managed by the unit through the appropriate potential free contact present in the electrical panel.**

Cold side water flow-rate

For a proper unit operation is necessary to guarantee the cold user side water flow rate also when chilled water is not required. It is therefore necessary to maintain in stand-by and available at the start-up the primary circuit pumps also in the cold season.

If the pumping unit is not built-in installed, **the external pump start signal must be managed by the unit through the appropriate potential free contact present in the electrical panel.**

System water volume

For a proper unit operation is necessary to contemplate a correct design of water tanks both on cold user side and hot user side. Minimum system water volumes are described within 'General technical data' section and they have to be satisfied to avoid continuous compressor switching on and off. The values indicated guarantee: the operation stability and performance, the protection of all components subject to wear, the maintenance of the set-point even under the most extreme conditions of air conditioning (high heating capacity requests with low cooling capacity requests).

In the presence of a primary-secondary system, in the calculation of the minimum water flow rate volume it is possible to consider also the secondary volume only if it remains active (operating pumps) in all the load conditions.

Operation with outdoor air temperature lower than +5°C

If the system requires only hot load: the unit produces only hot water at hot user side with cool rejection on the external heat source.

If the system requires only cold load: the unit produces only chilled water at cold user side with heat rejection on the external heat source.

If the system requires simultaneously cold and hot load: the unit produces only chilled water at cold user side, and supply the hot user side with the desuperheating heat. The unit remains in chiller mode with partial recovery until the cold load is not fulfilled. Once fulfilled it, the unit switches to a only hot water production mode on the hot user side.

Process applications

For process applications with variable heat loads and constant set temperatures throughout the year, please contact Clivet's Technical Department to evaluate the most appropriate solution.

Configuration for 4-pipe system

Unit configuration

WSAN-XSC3 MF **200 . 4** **4T** **EXC** **SC** **AXIX** **-** **-**

(1) (2) (3) (4) (5) (6) (7) (8) (9)

(1) Range

WSAN = Air cooled heat pump with scroll compressor
XSC3 = SPINchiller³ range
MF = Multifunction

(2) Size

200 = Nominal compressor capacity (HP)

(3) Compressors

4 = Compressor quantity

(4) System configuration

4T = Configuration for 4 pipe systems

(5) Energy efficiency

EXC = EXCELLENCE version: high energy efficiency

(6) Acoustic configuration

SC = Acoustic configuration with compressor soundproofing

EN = Super-silenced acoustic configuration

(7) Fan diffusers

AXIX - Diffuser for high efficiency fan (standard - separately supplied)

NAXI - Diffuser not required

(8) Pumping unit cold user side

(-) not required

2PM - Hydropack user side with no. 2 of ON/OFF pumps

3PM - Hydropack user side con no. 3 of ON/OFF pumps

2PMV - Hydropack user side with no. 2 of inverter pumps

3PMV - Hydropack user side with no. 3 of inverter pumps

(9) Pumping unit hot user side

(-) not required

HYGR2V - Hydropack recovery side with no. 2 of inverter pumps

HYGR3V - Hydropack recovery side with no. 3 of inverter pumps

Hydraulic side	Hydronic units		
COLD USER SIDE Chilled water production	1.1 Standard unit 	1.2 Standard unit with HYDROPACK ON/OFF 	1.3 Standard unit with HYDROPACK activated by inverter
	2.1 Standard unit 	2.2 Standard unit with HYDROPACK ON/OFF 	2.3 Standard unit with HYDROPACK activated by inverter

Accessories separately supplied		
<ul style="list-style-type: none"> • RCMRX - Remote control via microprocessor remote control 	<ul style="list-style-type: none"> • PSX - Mains power supply unit 	<ul style="list-style-type: none"> • AMMX - Spring antivibration mounts

Configuration for 4-pipe system

Acoustic configuration: compressor soundproofing (SC)

General technical data - Performance

Size			90.4	100.4	110.4	120.4	140.4	160.4	180.4	200.4	220.4	240.4
Cooling												
Cooling capacity	1	[kW]	259	275	298	340	385	434	503	545	602	650
Compressor power input	1	[kW]	78,3	85,6	94,6	108	123	137	158	172	188	208
Total power input	2	[kW]	87,9	95,2	104	118	135	150	173	188	204	224
EER	1	-	2,95	2,89	2,86	2,88	2,84	2,90	2,90	2,91	2,95	2,90
SEER	9	-	4,16	4,14	4,13	4,16	4,16	4,13	4,24	4,24	4,22	4,16
Water flow-rate	1	[l/s]	12,4	13,1	14,3	16,3	18,4	20,7	24,0	26,0	28,8	31,1
Cold user side exchanger pressure drops	1	[kPa]	34,3	38,3	33,9	43,4	46,1	45,6	40,0	46,7	43,8	50,9
Cooling capacity (EN14511:2013)	3	[kW]	258	274	297	339	383	433	502	543	600	648
Total power input (EN14511:2013)	3	[kW]	88,8	96,1	105	119	137	151	175	189	206	227
EER (EN 14511:2013)	3	-	2,91	2,85	2,82	2,84	2,80	2,86	2,87	2,87	2,91	2,86
ESEER (EN 14511:2013)	3	-	4,26	4,30	4,32	4,30	4,28	4,42	4,40	4,45	4,44	4,34
Cooling capacity (AHRI 550/590)	7	[kW]	258	273	297	339	382	432	502	544	600	648
Compressor power input (AHRI 550/590)	7	[kW]	78,2	85,6	94,5	108	122	136	157	171	188	208
Total power input (AHRI 550/590)	7	[kW]	87,8	95,2	104	118	134	149	172	187	204	224
COPr	7	-	2,94	2,87	2,86	2,87	2,85	2,90	2,92	2,91	2,94	2,89
IPLV	7	-	4,79	4,82	4,84	4,80	4,78	4,97	4,92	4,97	4,96	4,87
Heating												
Heating capacity	4	[kW]	295	326	355	395	445	492	567	627	675	728
Compressor power input	4	[kW]	72,3	79,9	87,3	97	108	120	140	155	171	184
Total power input	2	[kW]	81,9	89,5	97	106	121	133	156	171	187	200
COP	4	-	3,60	3,64	3,66	3,72	3,69	3,70	3,64	3,67	3,61	3,64
SCOP - AVERAGE Climate W35	9	-	4,08	4,10	4,12	3,95	4,16	3,94	-	-	-	-
Water flow-rate	4	[l/s]	14,1	15,6	17,0	18,9	21,3	23,5	27,1	30,0	32,3	34,8
Hot user side exchanger pressure drops	4	[kPa]	40,2	47,9	38,3	46,6	35,4	42,9	31,8	38,8	45,2	46,2
Heating capacity (EN14511:2013)	5	[kW]	296	327	356	397	446	494	568	629	677	731
Total power input (EN14511:2013)	5	[kW]	82,9	90,8	98	108	122	135	157	173	189	203
COP (EN 14511:2013)	5	[kW]	3,57	3,60	3,63	3,68	3,66	3,67	3,62	3,64	3,58	3,61
Cooling 100% - Heating 100%												
Cooling capacity	6	[kW]	255	275	305	344	397	442	509	556	612	670
Heating capacity	6	[kW]	331	357	396	447	513	573	658	720	794	866
Total power input	6	[kW]	76,6	82,6	91,2	103	117	132	150	164	183	197
Global efficiency	8	[kW]	7,65	7,64	7,69	7,66	7,76	7,68	7,80	7,76	7,70	7,79

The Product is compliant with the Erp (Energy Related Products) European Directive. It includes the Commission delegated Regulation (EU) No 811/2013 (rate heat output ≤ 70 kW at specified reference conditions) and the Commission delegated Regulation (EU) No 813/2013 (rated heat output ≤ 400 kW at specified reference conditions).

Contains fluorinated greenhouse gase (GWP 2087,5)

- Data referred to the following conditions: internal exchanger water = 12/7 °C. Entering external exchanger air temperature 35°C. Internal exchanger fouling factor = $0.44 \times 10^{(-4)}$ m² K/W. Considering cooling only operation.
- The Total Power Input value does not take into account the part related to the pumps and required to overcome the pressure drops for the circulation of the solution inside the exchangers
- Data compliant to Standard EN 14511:2013 referred to the following conditions: - Internal exchanger water temperature = 12/7°C - Entering external exchanger air temperature = 35°C. Considering cooling only operation.
- Data referred to the following conditions: internal exchanger water = 40/45 °C. Entering external exchanger air temperature = 7°C D.B./6°C W.B. Internal exchanger fouling factor = $0.44 \times 10^{(-4)}$ m² K/W. Considering heating only operation.
- Data compliant to Standard EN 14511:2013 referred to the following conditions: - Internal exchanger water temperature = 40/45 °C. Entering external exchanger air temperature = 7°C D.B./6°C W.B. Considering heating only operation.
- Data referred to the following conditions: exchanger water cooling side = 12/7 °C. exchanger water heating side = 40/45°C. Exchanger fouling factor = $0.44 \times 10^{(-4)}$ m² K/W
- Data compliant to Standard AHRI 550/590 referred to the following conditions: internal exchanger water temperature = 6,7 °C. Water flow-rate 0,043 l/s per kW. Entering external exchanger air temperature 35°C. Internal exchanger fouling factor = $0.18 \times 10^{(-4)}$ m² K/W. Considering cooling only operation.
- Global Efficiency = (Cooling capacity + Heating capacity) / Total power input
- Data calculated according to the EN 14825:2016 Regulation

Configuration for 4-pipe system

Acoustic configuration: super-silenced (EN)

General technical data - Performance

Size			90.4	100.4	110.4	120.4	140.4	160.4	180.4	200.4	220.4	240.4
Cooling												
Cooling capacity	1	[kW]	248	263	288	326	369	413	481	524	574	618
Compressor power input	1	[kW]	82,4	89,3	98,6	115	129	143	166	179	199	224
Total power input	2	[kW]	89,4	96,3	106	122	138	152	178	191	211	235
EER	1	-	2,78	2,73	2,72	2,67	2,68	2,72	2,71	2,75	2,72	2,63
SEER	9	-	4,13	4,11	4,11	4,09	4,12	4,10	4,16	4,15	4,14	4,14
Water flow-rate	1	[l/s]	11,9	12,6	13,7	15,6	17,6	19,7	23,0	25,0	27,4	29,5
Cold user side exchanger pressure drops	1	[kPa]	31,6	35,2	31,6	39,9	42,5	41,5	36,7	43,3	39,9	46,0
Cooling capacity (EN14511:2013)	3	[kW]	248	262	287	307	367	412	479	522	572	616
Total power input (EN14511:2013)	3	[kW]	90,2	97,2	107	123	139	153	179	192	213	237
EER (EN 14511:2013)	3	-	2,74	2,70	2,69	2,50	2,65	2,68	2,68	2,72	2,69	2,60
ESEER (EN 14511:2013)	3	-	4,16	4,26	4,24	4,24	4,19	4,29	4,22	4,30	4,30	4,21
Cooling capacity (AHRI 550/590)	7	[kW]	247	262	286	325	367	411	480	522	572	616
Compressor power input (AHRI 550/590)	7	[kW]	82,2	89,1	98,4	115	128	142	166	179	199	223
Total power input (AHRI 550/590)	7	[kW]	89,2	96,1	106	122	137	151	178	191	211	234
COPr	7	-	2,77	2,73	2,70	2,66	2,68	2,72	2,70	2,73	2,71	2,63
IPLV	7	-	4,65	4,78	4,74	4,75	4,68	4,78	4,71	4,83	4,82	4,73
Heating												
Heating capacity	4	[kW]	295	326	355	395	445	492	567	627	675	728
Compressor power input	4	[kW]	72,3	79,9	87,3	97	108	120	140	155	171	184
Total power input	2	[kW]	81,9	89,5	97	106	121	133	156	171	187	200
COP	4	-	3,60	3,64	3,66	3,72	3,69	3,70	3,64	3,67	3,61	3,64
SCOP - AVERAGE Climate W35	9	-	4,08	4,10	4,12	3,95	4,16	3,94	-	-	-	-
Water flow-rate	4	[l/s]	14,1	15,6	17,0	18,9	21,3	23,5	27,1	30,0	32,3	34,8
Hot user side exchanger pressure drops	4	[kPa]	40,2	47,9	38,3	46,6	35,4	42,9	31,8	38,8	45,2	46,2
Heating capacity (EN14511:2013)	5	[kW]	296	327	356	397	446	494	568	629	677	731
Total power input (EN14511:2013)	5	[kW]	82,9	90,8	98	108	122	135	157	173	189	203
COP (EN 14511:2013)	5	[kW]	3,57	3,60	3,63	3,68	3,66	3,67	3,62	3,64	3,58	3,61
Cooling 100% - Heating 100%												
Cooling capacity	6	[kW]	255	275	305	344	397	442	509	556	612	670
Heating capacity	6	[kW]	331	357	396	447	513	573	658	720	794	866
Total power input	6	[kW]	76,6	82,6	91,2	103	117	132	150	164	183	197
Global efficiency	8	[kW]	7,65	7,64	7,69	7,66	7,76	7,68	7,80	7,76	7,70	7,79

The Product is compliant with the Erp (Energy Related Products) European Directive. It includes the Commission delegated Regulation (EU) No 811/2013 (rate heat output ≤ 70 kW at specified reference conditions) and the Commission delegated Regulation (EU) No 813/2013 (rated heat output ≤ 400 kW at specified reference conditions).

Contains fluorinated greenhouse gas (GWP 2087,5)

- Data referred to the following conditions: internal exchanger water = 12/7 °C. Entering external exchanger air temperature 35°C. Internal exchanger fouling factor = $0.44 \times 10^{(-4)}$ m² K/W. Considering cooling only operation.
- The Total Power Input value does not take into account the part related to the pumps and required to overcome the pressure drops for the circulation of the solution inside the exchangers
- Data compliant to Standard EN 14511:2013 referred to the following conditions: - Internal exchanger water temperature = 12/7°C - Entering external exchanger air temperature = 35°C. Considering cooling only operation.
- Data referred to the following conditions: internal exchanger water = 40/45 °C. Entering external exchanger air temperature = 7°C D.B./6°C W.B. Internal exchanger fouling factor = $0.44 \times 10^{(-4)}$ m² K/W. Considering heating only operation.
- Data compliant to Standard EN 14511:2013 referred to the following conditions: - Internal exchanger water temperature = 40/45 °C. Entering external exchanger air temperature = 7°C D.B./6°C W.B. Considering heating only operation.
- Data referred to the following conditions: exchanger water cooling side = 12/7 °C. exchanger water heating side = 40/45°C. Exchanger fouling factor = $0.44 \times 10^{(-4)}$ m² K/W
- Data compliant to Standard AHRI 550/590 referred to the following conditions: internal exchanger water temperature = 6,7 °C. Water flow-rate 0,043 l/s per kW. Entering external exchanger air temperature 35°C. Internal exchanger fouling factor = $0.18 \times 10^{(-4)}$ m² K/W. Considering cooling only operation.
- Global Efficiency = (Cooling capacity + Heating capacity) / Total power input
- Data calculated according to the EN 14825:2016 Regulation

Configuration for 4-pipe system

Acoustic configuration: compressor soundproofing (SC)

General technical data - Construction

Size			90.4	100.4	110.4	120.4	140.4	160.4	180.4	200.4	220.4	240.4
Compressor												
Type of compressors		-	Scroll	Scroll	Scroll	Scroll	Scroll	Scroll	Scroll	Scroll	Scroll	Scroll
Refrigerant			R-410A	R-410A	R-410A	R-410A	R-410A	R-410A	R-410A	R-410A	R-410A	R-410A
No. of compressors		No	4	4	4	4	4	4	4	4	4	4
Rated power (C1)		[HP]	45	50	55	60	70	80	90	100	100	120
Rated power (C2)		[HP]	45	50	55	60	70	80	90	100	120	120
Std Capacity control steps		No	6	6	6	4	6	4	6	6	5	4
Oil charge (C1)		[l]	10	11	13	13	13	13	13	13	13	13
Oil charge (C2)		[l]	10	11	13	13	13	13	13	13	13	13
Refrigerant charge (C1)	1	[kg]	47	47	47	57	64	65	79	79	81	95
Refrigerant charge (C2)	1	[kg]	44	44	44	53	60	61	74	74	89	89
Refrigeration circuits		No	2	2	2	2	2	2	2	2	2	2
Internal exchanger												
Type of cold user side exchanger	2	-	PHE	PHE	PHE	PHE	PHE	PHE	PHE	PHE	PHE	PHE
Type of hot user side exchanger	2	-	PHE	PHE	PHE	PHE	PHE	PHE	PHE	PHE	PHE	PHE
Cold user side exchanger water content		[l]	24	24	29	29	32	37	49	49	62	62
Hot user side exchanger water content		[l]	14,4	14,4	18,0	18,0	25,2	25,2	43,2	43,2	54,0	54,0
Cold user side minimum system water content	3	[l]	3307	3511	3805	4938	4915	6303	6422	6958	7686	9439
Hot user side minimum system water content	3	[l]	2601	2875	3130	4106	3924	5115	5000	5529	5952	7568
External Section Fans												
Type of fans	4	-	AX	AX	AX	AX	AX	AX	AX	AX	AX	AX
Number of fans		No	6	6	6	6	8	8	10	10	10	10
Type of motor	5	-	AC/P	AC/P	AC/P	AC/P	AC/P	AC/P	AC/P	AC/P	AC/P	AC/P
Standard airflow		[l/s]	37357	37357	36797	36365	49807	49063	62677	61219	60854	60489
Connections												
Cold user side water fittings		-	4"	4"	4"	4"	4"	5"	5"	5"	5"	5"
Hot user side water fittings		-	4"	4"	4"	4"	4"	5"	5"	5"	5"	5"
Power supply												
Standard power supply		V	400/3~/50	400/3~/50	400/3~/50	400/3~/50	400/3~/50	400/3~/50	400/3~/50	400/3~/50	400/3~/50	400/3~/50
Electrical data												
FLA Total		A	205,2	216,5	233,3	262,1	299,3	328,3	387,9	416,9	457,1	497,3
FLI Total		kW	117,7	128,6	138,2	155,8	180,7	201,9	231,2	252,4	275,8	299,2
M.I.C. - Value	6	A	455,6	466,9	483,7	512,5	619,2	648,2	657,6	686,6	726,8	767,0
M.I.C. - with soft start accessory	6	A	317,8	329,1	345,9	374,7	447,2	476,2	657,6	686,6	726,8	767,0

- Indicative values for standard units with possible +/-10% variation. The actual data are indicated on the label of the unit.
- PHE = Plate exchanger
- Water volume necessary for the proper unit operation (for more details see 'Considerations on the application')
- AX = axial fan
- AC/P = asynchronous three-phase external rotor motor with phase cutting speed automatic control

- Unbalance between phase max 2% Voltage variation: max +/- 10%
- Electrical data refer to standard units; according to the installed accessories, the data can suffer some variations.
- M.I.C.=Maximum unit starting current. The M.I.C. value is obtained adding the max. compressor starting current of the highest size to the power input at max. admissible conditions (F.L.A.) of the remaining electric components.

Sound levels

Size	Sound power level (dB)								Sound power level dB(A)	Sound pressure level dB(A)
	Octave band (Hz)									
	63	125	250	500	1000	2000	4000	8000		
90.4	93	90	90	88	88	85	71	62	92	72
100.4	93	90	90	88	88	85	71	62	92	72
110.4	93	90	90	88	88	85	71	62	92	72
120.4	93	90	90	88	88	85	71	62	92	72
140.4	94	91	91	89	89	86	72	63	92	72
160.4	95	92	92	90	90	87	73	64	93	73
180.4	101	97	96	93	89	84	78	72	95	74
200.4	101	97	96	93	89	84	78	72	95	74
220.4	102	98	97	94	90	85	79	73	95	74
240.4	102	98	97	94	90	85	79	73	95	75

The sound levels refer to standard unit with Axitop (no accessories) at full load, in test nominal conditions. The sound pressure level refers to 1 m. from the standard unit outer surface operating in open field. Measures are according to UNI EN ISO 9614-2 regulations, with respect to the EUROVENT 8/1 certification, which provides for a tolerance of 3 dB(A) on the sound power level, which is the only acoustic data to be considered binding. If unit is set without Axitop, the sound power level presents an increase up to 3 dB(A).

Data referred to the following conditions.
 - internal exchanger water = 12/7 °C
 - Ambient temperature = 35 °C

Configuration for 4-pipe system

Acoustic configuration: super-silenced (EN)

General technical data - Construction

Size			90.4	100.4	110.4	120.4	140.4	160.4	180.4	200.4	220.4	240.4
Compressor												
Type of compressors		-	Scroll	Scroll	Scroll	Scroll	Scroll	Scroll	Scroll	Scroll	Scroll	Scroll
Refrigerant			R-410A	R-410A	R-410A	R-410A	R-410A	R-410A	R-410A	R-410A	R-410A	R-410A
No. of compressors		No	4	4	4	4	4	4	4	4	4	4
Rated power (C1)		[HP]	45	50	55	60	70	80	90	100	100	120
Rated power (C2)		[HP]	45	50	55	60	70	80	90	100	120	120
Std Capacity control steps		No	6	6	6	4	6	4	6	6	5	4
Oil charge (C1)		[l]	10	11	13	13	13	13	13	13	13	13
Oil charge (C2)		[l]	10	11	13	13	13	13	13	13	13	13
Refrigerant charge (C1)	1	[kg]	47	47	47	57	64	65	79	79	81	95
Refrigerant charge (C2)	1	[kg]	44	44	44	53	60	61	74	74	89	89
Refrigeration circuits		No	2	2	2	2	2	2	2	2	2	2
Internal exchanger												
Type of cold user side exchanger	2	-	PHE	PHE	PHE	PHE	PHE	PHE	PHE	PHE	PHE	PHE
Type of hot user side exchanger	2	-	PHE	PHE	PHE	PHE	PHE	PHE	PHE	PHE	PHE	PHE
Cold user side exchanger water content		[l]	24	24	29	29	32	37	49	49	62	62
Hot user side exchanger water content		[l]	14,4	14,4	18,0	18,0	25,2	25,2	43,2	43,2	54,0	54,0
Cold user side minimum system water content	3	[l]	3307	3511	3805	4938	4915	6303	6422	6958	7686	9439
Hot user side minimum system water content	3	[l]	2601	2875	3130	4106	3924	5115	5000	5529	5952	7568
External Section Fans												
Type of fans	4	-	AX	AX	AX	AX	AX	AX	AX	AX	AX	AX
Number of fans		No	6	6	6	6	8	8	10	10	10	10
Type of motor	5	-	AC/P	AC/P	AC/P	AC/P	AC/P	AC/P	AC/P	AC/P	AC/P	AC/P
Standard airflow		[l/s]	30588	30588	29943	29570	40784	39924	50870	49776	49467	49159
Connections												
Cold user side water fittings		-	4"	4"	4"	4"	4"	4"	4"	4"	5"	5"
Hot user side water fittings		-	4"	4"	4"	4"	4"	4"	4"	4"	5"	5"
Power supply												
Standard power supply		V	400/3~/50	400/3~/50	400/3~/50	400/3~/50	400/3~/50	400/3~/50	400/3~/50	400/3~/50	400/3~/50	400/3~/50
Electrical data												
FLA Total		A	205,2	216,5	233,3	262,1	299,3	328,3	387,9	416,9	457,1	497,3
FLI Total		kW	117,7	128,6	138,2	155,8	180,7	201,9	231,2	252,4	275,8	299,2
M.I.C. - Value	6	A	455,6	466,9	483,7	512,5	619,2	648,2	657,6	686,6	726,8	767,0
M.I.C. - with soft start accessory	6	A	317,8	329,1	345,9	374,7	447,2	476,2	657,6	686,6	726,8	767,0

- Indicative values for standard units with possible +/-10% variation. The actual data are indicated on the label of the unit.
- PHE = Plate exchanger
- Water volume necessary for the proper unit operation (for more details see 'Considerations on the application')
- AX = axial fan
- AC/P = asynchronous three-phase external rotor motor with phase cutting speed automatic control

Unbalance between phase max 2% Voltage variation: max +/- 10%
 Electrical data refer to standard units; according to the installed accessories, the data can suffer some variations.
 6. M.I.C.=Maximum unit starting current. The M.I.C. value is obtained adding the max. compressor starting current of the highest size to the power input at max. admissible conditions (F.L.A.) of the remaining electric components.

Sound levels

Size	Sound power level (dB)								Sound power level dB(A)	Sound pressure level dB(A)
	Octave band (Hz)									
	63	125	250	500	1000	2000	4000	8000		
90.4	87	84	84	82	82	79	65	56	86	66
100.4	87	84	84	82	82	79	65	56	86	66
110.4	87	84	84	82	82	79	65	56	86	66
120.4	88	85	85	83	83	80	66	57	86	66
140.4	88	85	85	83	83	80	66	57	86	66
160.4	89	86	86	84	84	81	67	58	87	67
180.4	96	92	91	88	84	79	73	67	90	69
200.4	96	92	91	88	84	79	73	67	90	69
220.4	97	93	92	89	85	80	74	68	90	69
240.4	97	93	92	89	85	80	74	68	90	70

The sound levels refer to standard unit with Axitop (no accessories) at full load, in test nominal conditions. The sound pressure level refers to 1 m. from the standard unit outer surface operating in open field.
 Measures are according to UNI EN ISO 9614-2 regulations, with respect to the EUROVENT 8/1 certification, which provides for a tolerance of 3 dB(A) on the sound power level, which is the only acoustic data to be considered binding.

If unit is set without Axitop, the sound power level presents an increase up to 3 dB(A).

Data referred to the following conditions.

- internal exchanger water = 12/7 °C
- Ambient temperature = 35 °C

The indicated sound levels are only valid within the operating field of the standard unit at full load as indicated in the 'Operating range - cooling' graph in the "Super-silenced EN" configuration. With outdoor air temperatures the unit operates at full load automatically increasing the airflow and taking the same sound levels of the "Soundproofed Compressors SC" configuration.

Configuration for 4-pipe system

Operating range in cooling

Compressor soundproofing (SC)

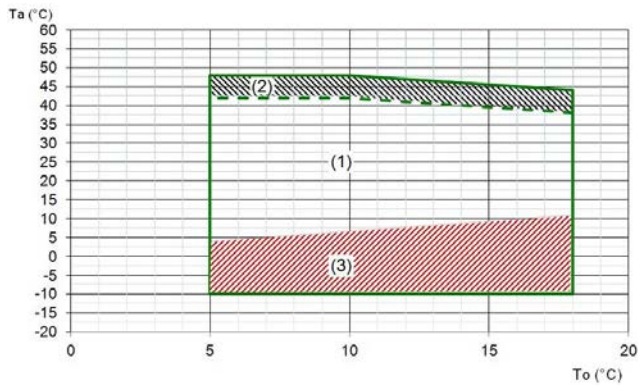

Ta (°C) = external exchanger inlet air temperature (D.B.)
To (°C) = internal exchanger outlet water temperature

1. Standard unit operating range at full load
2. Unit operating range with automatic staging of the compressor capacity
3. Standard unit operating range with air flow automatic modulation

Super-silenced (EN)

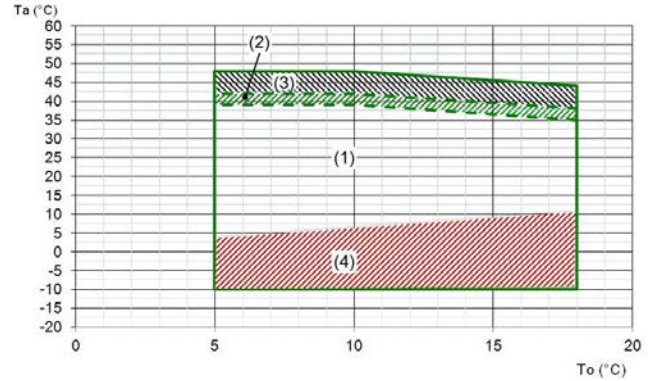

Ta (°C) = external exchanger inlet air temperature (D.B.)
To (°C) = internal exchanger outlet water temperature

1. Standard unit operating range at full load
2. Extended operating range with air flow-rate automatic increasing. Inside this field the sound levels are the same of the 'compressor soundproofing (SC)' acoustic configuration
3. Unit operating range with automatic staging of the compressor capacity
4. Standard unit operating range with air flow automatic modulation

Operating range in heating

Compressor soundproofing (SC) / Super-silenced (EN)

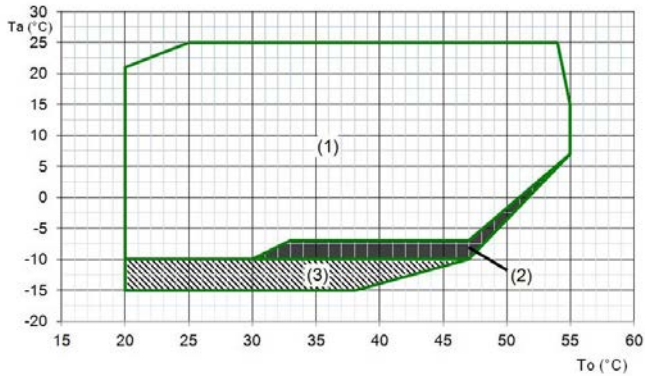

Ta (°C) = external exchanger inlet air temperature (D.B.)
To (°C) = internal exchanger outlet water temperature

1. Standard unit operating range at full load
2. Unit operating range with 'OHE' - operating range extension kit up to -10°C (W.B.)
3. Range in which the unit operation is allowed only for a limited period (max 1 hour)

Operating range - Cooling 100% - Heating 100%

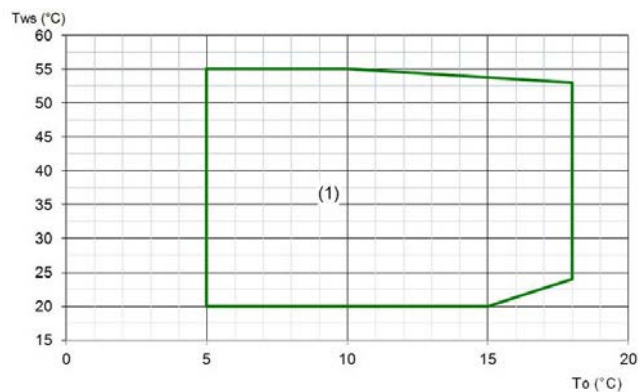

Tws (°C) = leaving hot user side exchanger water temperature
To (°C) = leaving cold user side exchanger water temperature

1. The water-water mode is applied with outdoor air temperatures higher than 5 °C. For lower temperatures the unit guarantees the hot and cold production alternating the chiller plus desuperheater operation, recovery only

Configuration for 4-pipe system

Admissible water flow-rates

Minimum (Qmin) and maximum (Qmax) admissible water flow for the unit to operate correctly.

Cold user side exchanger

EXCELLENCE SC/EN		90.4	100.4	110.4	120.4	140.4	160.4	180.4	200.4	220.4	240.4
Qmin	[l/s]	8,0	8,0	9,3	9,3	10,1	11,5	14,3	14,3	16,4	16,4
Qmax	[l/s]	21,8	21,8	25,1	25,1	27,5	31,2	38,6	38,6	44,0	44,0

Hot user side exchanger

EXCELLENCE SC/EN		90.4	100.4	110.4	120.4	140.4	160.4	180.4	200.4	220.4	240.4
Qmin	[l/s]	8,5	8,5	10,4	10,4	13,6	13,6	18,6	18,6	19,2	19,8
Qmax	[l/s]	22,7	22,7	22,7	22,7	36,3	36,3	48,3	48,3	49,8	51,4

Correction factors for glycol use

% ethylene glycol by weight		5%	10%	15%	20%	25%	30%	35%	40%
Freezing temperature	°C	-2,0	-3,9	-6,5	-8,9	-11,8	-15,6	-19,0	-23,4
Safety temperature	°C	3,0	1,0	-1,0	-4,0	-6,0	-10,0	-14,0	-19,0
Cooling Capacity Factor	Nr	0,997	0,994	0,99	0,986	0,981	0,976	0,970	0,964
Compressor power input Factor	Nr	1,000	1,001	1,001	1,001	1,001	1,002	1,002	1,002
Internal exchanger glycol solution flow factor	Nr	1,003	1,010	1,020	1,033	1,05	1,072	1,095	1,124
Pressure drop Factor	Nr	0,989	0,983	0,979	0,980	0,984	0,993	1,004	1,020

The correction factors shown refer to water and glycol ethylene mixes used to prevent the formation of frost on the exchangers in the water circuit during inactivity in winter.

Fouling Correction Factors

m ² K / W	Internal exchanger	
	F1	FK1
0.44 x 10 (-4)	1,0	1,0
0.88 x 10 (-4)	0,97	0,99
1.76 x 10 (-4)	0,94	0,98

F1 = Cooling capacity correction factors

FK1 = Compressor power input correction factor

Overload and control device calibrations

			open	closed	value
High pressure safety pressure switch		[kPa]	4050	3300	-
Antifreeze protection		[°C]	4	5.5	-
High pressure safety valve		[kPa]	-	-	4500
Low pressure safety valve		[kPa]	-	-	2950
Max no. of compressor starts per hour		[n°]	-	-	10
High compressor discharge temperature safety thermostat		[°C]	-	-	140

Exchanger operating range

	Internal exchanger			
	DPr		DPw	
PED (CE)	4500		1000	

DPr = Maximum operating pressure on refrigerant side in kPa

DPw = Maximum operating pressure on water side in kPa

Configuration for 4-pipe system

Acoustic configuration: compressor soundproofing (SC)

Cooling performance

(continued)

Size	To (°C)	ENTERING EXTERNAL EXCHANGER AIR TEMPERATURE (°C)											
		25		30		35		40		42		48	
		kWf	kWe	kWf	kWe	kWf	kWe	kWf	kWe	kWf	kWe	kWf	kWe
90.4	5	279	63.6	262	70.1	244	77.0	222	85.6	214	90.8	74.7	28.3
	6	287	64.3	270	70.5	252	77.8	228	87.6	220	91.1	77.0	28.4
	7	296	64.7	279	71.3	259	78.3	234	87.7	227	91.3	79.3	28.5
	10	316	66.1	298	72.7	274	79.9	249	88.8	243	92.5	85.0	28.8
	15	355	69.1	331	75.3	307	83.2	284	92.1	175	48.5	-	-
	18	381	70.9	356	77.7	331	85.2	305	95.5	192	49.6	-	-
100.4	5	295	69.7	279	76.3	260	84.7	237	94.5	228	98.2	95.8	36.3
	6	307	70.2	289	77.1	266	85.5	244	96.0	236	99.6	98.9	36.9
	7	315	70.6	296	77.9	275	85.6	248	97.4	244	101	102	37.4
	10	337	72.3	317	79.4	291	87.8	266	98.6	260	105	109	38.9
	15	374	75.7	351	82.7	326	91.0	304	102	203	61.1	-	-
	18	412	77.9	388	85.4	357	93.9	336	107	227	63.2	-	-
110.4	5	325	76.0	304	84.3	283	93.2	257	105	248	111	146	61.7
	6	336	77.2	315	85.2	290	94.1	265	106	257	111	151	61.7
	7	344	78.0	322	86.0	298	94.6	272	106	265	112	156	62.4
	10	369	79.6	345	87.7	318	96.2	288	109	277	116	163	64.6
	15	409	82.7	382	91.2	354	99.9	332	115	198	60.9	-	-
	18	451	85.4	422	93.2	388	103	370	119	223	62.3	-	-
120.4	5	368	87.6	348	95.9	321	106	294	118	284	124	150	61.2
	6	379	88.3	357	96.9	332	107	305	119	294	126	155	61.9
	7	393	89.0	369	97.9	340	108	311	121	300	128	158	62.8
	10	419	90.5	391	99.9	360	110	329	123	317	131	167	64.4
	15	469	94.7	438	104	404	115	378	128	211	58.7	-	-
	18	508	98.0	479	107	443	118	416	134	231	59.6	-	-
140.4	5	416	100	391	110	362	121	334	134	320	142	154	59.5
	6	427	101	402	111	373	121	345	134	333	143	160	60.0
	7	442	102	416	112	385	123	354	136	341	144	164	60.5
	10	471	105	441	114	405	125	375	138	363	149	174	62.8
	15	519	109	487	119	452	130	429	148	260	78.3	-	-
	18	575	113	534	123	498	134	475	154	292	80.2	-	-
160.4	5	471	112	445	122	411	134	374	150	359	160	191	79.9
	6	483	113	456	123	423	135	385	151	372	160	197	80.1
	7	499	115	471	125	434	137	396	152	385	162	204	80.6
	10	526	118	495	127	458	139	419	154	413	165	219	82.1
	15	588	123	548	133	510	146	471	160	276	73.9	-	-
	18	645	127	607	137	562	151	519	163	305	75.0	-	-
180.4	5	554	127	519	141	479	155	438	175	425	182	160	60.7
	6	573	129	535	142	495	157	448	176	436	184	164	61.2
	7	584	130	546	143	503	158	457	176	444	185	167	61.6
	10	613	133	572	145	527	160	492	181	466	190	175	63.3
	15	686	139	639	152	591	166	550	189	376	117	-	-
	18	744	143	690	156	640	171	593	194	416	119	-	-

kWf = Cooling capacity in kW. The data do not consider the part related to the pumps, required to overcome the pressure drop for the solution circulation inside the exchangers

kWe = Compressor power input in kW

To (°C) = leaving internal exchanger water temperature (°C) - Performances in function of the inlet/outlet water temperature differential = 5°C

Configuration for 4-pipe system

Acoustic configuration: compressor soundproofing (SC)

Cooling performance

Size	To (°C)	ENTERING EXTERNAL EXCHANGER AIR TEMPERATURE (°C)											
		25		30		35		40		42		48	
		kWf	kWe	kWf	kWe	kWf	kWe	kWf	kWe	kWf	kWe	kWf	kWe
200.4	5	596	141	559	154	519	169	480	185	469	192	287	119
	6	611	143	574	156	536	170	496	187	482	193	295	119
	7	628	145	588	157	545	172	506	188	493	194	302	120
	10	656	148	616	160	569	175	529	190	517	198	317	122
	15	722	155	684	169	638	183	600	199	399	112	-	-
	18	793	160	744	174	695	188	656	205	441	114	-	-
220.4	5	665	155	626	170	576	187	524	209	508	219	286	119
	6	682	157	642	171	590	188	537	209	518	222	292	121
	7	695	158	654	171	602	188	546	211	528	226	297	123
	10	727	160	679	174	626	192	566	218	559	233	315	127
	15	811	168	758	182	701	201	653	231	401	122	-	-
	18	878	173	819	188	760	206	722	235	444	125	-	-
240.4	5	716	171	675	187	623	207	562	227	549	242	287	118
	6	734	173	693	188	637	208	578	229	561	246	293	120
	7	748	175	707	188	650	208	594	232	572	249	299	122
	10	785	176	734	192	676	212	613	240	607	259	317	127
	15	872	184	813	200	757	220	705	255	404	116	-	-
	18	929	190	866	208	808	227	768	258	434	118	-	-

kWf = Cooling capacity in kW. The data do not consider the part related to the pumps, required to overcome the pressure drop for the solution circulation inside the exchangers

kWe = Compressor power input in kW

To (°C) = leaving internal exchanger water temperature (°C) - Performances in function of the inlet/outlet water temperature differential = 5°C

Configuration for 4-pipe system

Acoustic configuration: super-silenced (EN)

Cooling performance

(continued)

Size	To (°C)	ENTERING EXTERNAL EXCHANGER AIR TEMPERATURE (°C)											
		25		30		35		39		42		48	
		kWf	kWe	kWf	kWe	kWf	kWe	kWf	kWe	kWf	kWe	kWf	kWe
90.4	5	271	66.6	254	73.4	236	81.0	218	88.7	214	90.8	74.7	28.3
	6	280	67.3	263	74.2	242	81.8	225	89.8	220	91.1	77.0	28.4
	7	288	68.0	269	74.9	248	82.4	230	90.4	227	91.4	79.3	28.5
	10	308	69.5	287	76.3	264	84.2	246	91.3	243	92.5	85.0	28.8
	15	344	72.7	319	79.8	298	87.8	276	94.2	175	48.5	-	-
	18	366	75.2	344	82.4	316	90.8	295	95.9	190	49.6	-	-
100.4	5	288	72.2	269	79.5	249	87.6	229	97.0	228	98.2	95.8	36.3
	6	296	72.9	277	79.9	256	88.4	238	97.1	236	99.6	98.9	36.9
	7	306	73.7	286	81.1	263	89.3	244	98.0	244	101	102	37.4
	10	325	75.7	304	82.8	279	91.2	261	100	260	105	109	38.9
	15	362	79.2	339	86.4	315	95.4	291	104	203	61.1	-	-
	18	395	81.3	367	89.2	342	98.8	314	106	227	63.2	-	-
110.4	5	314	80.4	295	87.7	271	97.2	251	108	248	111	146	61.7
	6	325	81.0	303	88.5	279	97.7	261	108	257	111	151	61.7
	7	335	81.6	312	89.9	288	98.6	263	109	265	112	156	62.4
	10	357	83.4	332	91.2	304	101	282	111	277	116	163	64.6
	15	396	86.8	369	95.5	341	107	318	115	198	60.9	-	-
	18	433	89.4	404	98.4	374	109	349	117	224	62.3	-	-
120.4	5	357	92.6	334	102	308	113	289	123	284	124	150	61.2
	6	369	94.1	346	103	319	114	298	124	294	126	155	61.9
	7	378	95.1	354	104	326	115	305	126	300	128	158	62.8
	10	402	97.5	375	107	345	117	324	129	317	131	167	64.4
	15	447	102	418	111	387	124	362	134	211	58.7	-	-
	18	488	105	451	115	420	126	390	137	230	59.6	-	-
140.4	5	404	104	380	115	351	126	328	137	320	142	153	59.5
	6	419	106	391	116	360	127	339	139	333	143	160	60.0
	7	428	107	400	117	369	129	344	141	341	144	164	60.5
	10	454	110	424	120	390	131	363	147	362	149	174	62.8
	15	504	116	469	126	438	139	413	154	260	78.3	-	-
	18	551	119	516	130	482	143	454	158	292	80.2	-	-
160.4	5	456	116	425	127	393	140	369	153	359	160	191	79.9
	6	468	117	439	129	404	141	380	154	372	160	197	80.1
	7	483	119	450	130	413	143	385	156	385	162	204	80.6
	10	509	122	472	133	434	146	401	160	413	165	219	82.1
	15	563	128	524	140	486	155	456	166	276	73.9	-	-
	18	608	133	567	144	524	159	494	170	306	75.0	-	-
180.4	5	536	136	500	149	463	163	426	182	425	182	160	60.7
	6	552	137	513	151	473	165	435	183	436	184	164	61.2
	7	565	138	524	152	481	166	445	184	444	185	167	61.6
	10	592	141	548	154	505	169	472	186	466	190	175	63.3
	15	658	148	612	162	568	178	518	191	376	117	-	-
	18	704	152	656	166	610	184	550	196	413	119	-	-

kWf = Cooling capacity in kW. The data do not consider the part related to the pumps, required to overcome the pressure drop for the solution circulation inside the exchangers

kWe = Compressor power input in kW

To (°C) = leaving internal exchanger water temperature (°C) - Performances in function of the inlet/outlet water temperature differential = 5°C

Configuration for 4-pipe system

Acoustic configuration: super-silenced (EN)

Cooling performance

Size	To (°C)	ENTERING EXTERNAL EXCHANGER AIR TEMPERATURE (°C)											
		25		30		35		39		42		48	
		kWf	kWe	kWf	kWe	kWf	kWe	kWf	kWe	kWf	kWe	kWf	kWe
200.4	5	576	148	539	161	500	176	472	189	469	192	287	119
	6	590	150	551	163	512	177	485	191	482	193	295	119
	7	600	151	563	165	524	179	495	192	493	194	302	120
	10	631	155	589	168	548	183	518	195	517	198	317	122
	15	695	163	653	177	614	192	589	206	399	112	-	-
	18	754	168	705	182	667	198	636	210	441	114	-	-
220.4	5	647	161	602	177	551	196	510	218	512	219	288	119
	6	662	163	615	179	564	198	520	221	522	222	294	121
	7	676	164	627	180	574	199	531	220	532	226	299	123
	10	705	167	653	183	595	203	561	227	564	233	317	127
	15	783	176	726	192	670	215	613	237	404	122	-	-
	18	847	181	789	198	729	223	656	242	444	125	-	-
240.4	5	695	181	646	198	594	219	549	245	551	242	288	118
	6	711	183	661	200	607	221	561	249	564	246	294	120
	7	727	184	675	202	618	224	574	249	575	249	300	122
	10	758	187	702	205	641	227	602	254	609	259	318	127
	15	837	196	776	214	718	240	660	264	406	116	-	-
	18	906	202	846	222	787	246	710	270	435	118	-	-

kWf = Cooling capacity in kW. The data do not consider the part related to the pumps, required to overcome the pressure drop for the solution circulation inside the exchangers

kWe = Compressor power input in kW

To (°C) = leaving internal exchanger water temperature (°C) - Performances in function of the inlet/outlet water temperature differential = 5°C

Configuration for 4-pipe system

Acoustic configuration: compressor soundproofing (SC) / Acoustic configuration: super-silenced (EN)

Heating performance

(continued)

Size	Ta (°C) D.B./W.B.	LEAVING INTERNAL EXCHANGER WATER TEMPERATURE (°C)									
		35		40		45		50		55	
		kWt	kWe	kWt	kWe	kWt	kWe	kWt	kWe	kWt	kWe
90.4	-7/-8	215	56.5	213	63.0	211	70.1	-	-	-	-
	-5/-6	227	56.9	224	63.2	221	70.2	-	-	-	-
	0/-1	258	58.0	254	64.0	250	70.9	244	79.1	-	-
	2/1	272	58.4	268	64.5	263	71.2	256	79.5	-	-
	7/6	311	59.5	304	65.7	295	72.3	287	80.5	281	91.0
	12/11	361	61.0	267	53.7	183	44.5	328	82.2	321	92.7
100.4	-7/-8	235	62.6	234	69.7	230	77.4	-	-	-	-
	-5/-6	247	63.0	246	69.9	242	77.6	-	-	-	-
	0/-1	283	64.0	280	70.9	274	78.5	268	87.8	-	-
	2/1	299	64.4	295	71.3	289	78.9	283	88.3	-	-
	7/6	341	65.6	334	72.6	326	79.9	318	89.6	311	101
	12/11	396	67.3	385	74.3	374	81.6	364	91.4	356	103
110.4	-7/-8	258	68.5	255	76.0	252	84.3	-	-	-	-
	-5/-6	271	69.0	268	76.3	265	84.6	-	-	-	-
	0/-1	310	70.1	306	77.5	300	85.6	292	95.4	-	-
	2/1	327	70.6	322	78.1	315	86.1	307	95.9	-	-
	7/6	371	71.9	363	79.4	355	87.3	346	97.3	337	110
	12/11	430	73.7	419	81.2	407	89.0	395	99.2	386	112
120.4	-7/-8	287	76.2	284	84.7	282	94.1	-	-	-	-
	-5/-6	302	76.6	298	84.9	296	94.3	-	-	-	-
	0/-1	345	77.6	339	85.9	333	95.1	327	106	-	-
	2/1	364	78.1	357	86.4	350	95.5	343	107	-	-
	7/6	414	79.5	405	87.9	395	96.5	383	108	376	122
	12/11	480	81.5	467	89.9	454	98.6	439	110	432	125
140.4	-7/-8	325	84.2	324	93.2	320	103	-	-	-	-
	-5/-6	341	84.9	340	93.8	335	104	-	-	-	-
	0/-1	389	86.5	384	95.6	380	106	369	117	-	-
	2/1	410	87.3	405	96.4	397	106	388	118	-	-
	7/6	467	89.3	456	98.5	445	108	436	120	426	136
	12/11	540	92.0	527	101	511	111	499	123	487	139
160.4	-7/-8	359	92.3	356	102	351	113	-	-	-	-
	-5/-6	378	93.4	374	103	368	114	-	-	-	-
	0/-1	431	96.0	423	106	414	116	406	129	-	-
	2/1	454	97.0	446	107	436	118	428	130	-	-
	7/6	514	99.7	504	110	492	120	479	133	469	150
	12/11	597	103	582	113	566	124	549	137	536	154
180.4	-7/-8	417	109	415	122	408	136	-	-	-	-
	-5/-6	437	110	435	122	428	137	-	-	-	-
	0/-1	494	112	493	124	483	138	473	154	-	-
	2/1	522	113	516	125	507	139	496	155	-	-
	7/6	590	115	581	127	567	140	554	157	541	178
	12/11	683	117	668	129	648	143	633	159	616	180
200.4	-7/-8	460	119	457	132	448	147	-	-	-	-
	-5/-6	482	120	479	133	471	148	-	-	-	-
	0/-1	548	123	542	136	530	151	521	168	-	-
	2/1	578	124	570	137	559	152	547	169	-	-
	7/6	650	126	641	140	627	155	609	172	594	195
	12/11	752	130	735	143	718	157	694	175	677	198

kWt = Internal exchanger heating capacity (kW). The data do not consider the part related to the pumps, required to overcome the pressure drop for the solution circulation inside the exchangers.
The kWt heating capacity does not consider any defrosting cycles. For the real heating capacity calculation, including defrosting cycles, please refer to "Integrated heating capacities" table.

kWe = Compressor power input in kW

Ta = Entering external exchanger air temperature

D.B. = Dry bulb

W.B. = Wet bulb

With Ta below -5°C OHE - Limit extension kit in heating' accessory included.

Configuration for 4-pipe system

Acoustic configuration: compressor soundproofing (SC) / Acoustic configuration: super-silenced (EN)

Heating performance

Size	Ta (°C) D.B./W.B.	LEAVING INTERNAL EXCHANGER WATER TEMPERATURE (°C)									
		35		40		45		50		55	
		kWt	kWe	kWt	kWe	kWt	kWe	kWt	kWe	kWt	kWe
220.4	-7 / -8	497	132	494	147	483	165	-	-	-	-
	-5 / -6	520	133	518	148	508	166	-	-	-	-
	0 / -1	590	136	583	151	572	168	556	188	-	-
	2 / 1	623	137	613	152	601	169	586	189	-	-
	7 / 6	700	140	690	155	675	171	658	191	653	217
	12 / 11	807	143	792	158	769	174	748	194	741	220
240.4	-7 / -8	536	142	531	159	519	177	-	-	-	-
	-5 / -6	561	143	557	160	547	178	-	-	-	-
	0 / -1	632	146	630	162	614	180	603	203	-	-
	2 / 1	668	147	661	163	646	181	633	204	-	-
	7 / 6	753	149	740	166	728	184	706	206	689	235
	12 / 11	864	152	848	169	827	187	803	209	781	237

kWt = Internal exchanger heating capacity (kW). The data do not consider the part related to the pumps, required to overcome the pressure drop for the solution circulation inside the exchangers.

The kWt heating capacity does not consider any defrosting cycles. For the real heating capacity calculation, including defrosting cycles, please refer to "Integrated heating capacities" table.

kWe = Compressor power input in kW

Ta = Entering external exchanger air temperature

D.B. = Dry bulb

W.B. = Wet bulb

With Ta below -5°C 'OHE - Limit extension kit in heating' accessory included.

Integrated heating capacities

Entering external exchanger air temperature °C (D.B. / W.B.)	-7 / -8	-5 / -6	0 / -1	2 / 1	Other
Heating capacity multiplication coefficient	0,90	0,89	0,88	0,90	1,00

The integrated heating capacity represents the real heating capacity considering the defrost cycles too.

To obtain the integrated heating capacity multiply the heating performance value in kWt (shown in the heating performance tables) by the coefficients indicated in the table.

DB = dry bulb

WB = wet bulb

In case of below zero outdoor air temperature with a long period of heat pump operating mode it is necessary to help the evacuation of the water produced during the defrost cycle; this to avoid the formation of ice in the unit basement. Pay attention that the evacuation will not create inconveniences to things or persons.

Configuration for 4-pipe system

Acoustic configuration: compressor soundproofing (SC) / Acoustic configuration: super-silenced (EN)

Cooling 100% - Heating 100% performance

(continued)

Size	Tw (°C)	Leaving water temperature hot user side																							
		20/25				30/35				35/40				40/45				45/50				50/55			
		kWf	kWe	kWt	GLE	kWf	kWe	kWt	GLE	kWf	kWe	kWt	GLE	kWf	kWe	kWt	GLE	kWf	kWe	kWt	GLE	kWf	kWe	kWt	GLE
90.4	5	296	50,5	345	12,69	272	61,7	333	9,81	257	68,1	324	8,53	237	75,5	312	7,28	218	84,1	302	6,18	202	94,1	296	5,29
	6	305	50,7	355	13,03	281	61,9	342	10,05	265	68,4	333	8,75	247	75,8	323	7,52	226	84,5	310	6,35	209	94,4	303	5,43
	7	315	50,8	365	13,38	291	62,2	352	10,34	275	68,7	344	9,01	255	76,1	331	7,70	232	84,7	317	6,48	214	94,6	309	5,53
	10	342	51,3	392	14,28	314	62,8	376	10,96	297	69,3	366	9,55	273	76,7	350	8,12	249	85,5	334	6,81	230	95,2	325	5,83
	15	382	51,9	432	15,67	352	64,0	415	11,98	337	70,5	406	10,55	313	78,2	391	9,00	286	87,0	373	7,58	-	-	-	-
	18	415	52,3	465	16,82	383	64,8	447	12,81	362	71,2	433	11,16	338	79,2	417	9,54	308	88,0	396	8,00	-	-	-	-
100.4	5	316	54,7	370	12,54	291	66,4	357	9,76	276	73,3	349	8,53	257	81,6	339	7,30	234	91,2	326	6,14	217	102,4	320	5,25
	6	329	55,1	383	12,91	303	66,7	369	10,07	286	73,6	360	8,78	266	81,8	348	7,50	242	91,6	334	6,29	225	102,6	328	5,39
	7	339	55,4	393	13,21	312	67,0	379	10,31	294	73,8	368	8,97	275	82,1	357	7,69	250	91,9	342	6,45	232	102,9	336	5,52
	10	370	56,2	425	14,13	339	67,8	406	10,98	320	74,6	394	9,58	296	82,8	379	8,14	268	92,6	361	6,78	250	103,5	354	5,83
	15	414	57,5	470	15,37	382	69,3	450	12,02	362	75,9	437	10,54	335	84,3	419	8,93	308	94,2	402	7,54	-	-	-	-
	18	447	58,3	503	16,27	412	70,1	480	12,72	392	76,9	468	11,19	365	85,5	450	9,52	333	95,3	428	7,99	-	-	-	-
110.4	5	352	60,7	411	12,58	325	73,5	398	9,84	309	81,2	390	8,60	284	90,0	375	7,32	262	100,4	363	6,22	241	112,5	354	5,29
	6	363	61,0	423	12,90	336	73,7	409	10,11	319	81,5	400	8,83	297	90,4	387	7,57	271	100,7	372	6,38	249	112,8	363	5,43
	7	375	61,3	435	13,22	347	74,0	420	10,36	329	81,8	411	9,05	305	90,7	396	7,73	279	101,0	381	6,54	258	113,1	371	5,56
	10	407	62,1	467	14,08	377	74,8	451	11,06	354	82,5	436	9,57	328	91,3	419	8,18	299	101,7	401	6,89	276	113,6	391	5,87
	15	457	63,4	518	15,38	424	76,2	499	12,10	400	83,8	483	10,54	373	92,9	466	9,04	344	103,2	447	7,66	-	-	-	-
	18	493	64,4	555	16,27	457	77,2	533	12,83	435	84,9	519	11,24	403	93,8	497	9,59	372	104,3	476	8,13	-	-	-	-
120.4	5	398	68,7	465	12,57	368	83,3	451	9,84	348	92,0	439	8,56	321	102,1	423	7,29	296	114,1	410	6,19	274	128,0	403	5,29
	6	412	69,1	479	12,90	381	83,6	464	10,10	358	92,3	450	8,76	333	102,5	436	7,51	306	114,5	421	6,35	283	128,3	412	5,41
	7	428	69,6	496	13,28	395	84,0	478	10,39	372	92,7	464	9,02	344	102,9	447	7,69	315	114,9	431	6,49	292	128,6	421	5,54
	10	462	70,5	531	14,09	423	84,7	507	10,97	400	93,5	493	9,55	370	103,8	474	8,13	341	116,5	457	6,85	311	129,2	441	5,82
	15	514	72,0	584	15,25	477	86,6	562	12,00	449	95,2	544	10,44	421	105,7	526	8,97	385	117,6	502	7,54	-	-	-	-
	18	556	73,0	627	16,21	515	87,7	601	12,73	489	96,4	585	11,14	455	107,0	562	9,50	415	119,1	534	7,97	-	-	-	-
140.4	5	453	78,6	531	12,52	420	94,8	514	9,85	399	104,5	504	8,64	372	115,8	488	7,43	343	128,7	472	6,33	312	143,2	456	5,36
	6	468	79,2	546	12,81	434	95,3	529	10,09	412	105,0	517	8,85	385	116,2	501	7,62	354	129,3	483	6,48	325	143,8	469	5,53
	7	486	79,9	565	13,17	450	95,9	545	10,38	426	105,5	531	9,07	397	116,7	513	7,80	362	129,6	492	6,59	334	144,2	478	5,63
	10	523	81,2	604	13,88	485	97,2	582	10,98	457	106,6	564	9,58	426	117,8	544	8,23	388	130,8	519	6,93	357	145,3	503	5,92
	15	582	83,4	664	14,94	542	99,5	640	11,89	514	108,6	622	10,45	483	120,3	603	9,02	445	133,3	578	7,67	-	-	-	-
	18	633	85,4	717	15,80	585	101,1	685	12,56	559	110,5	669	11,12	521	122,0	642	9,53	481	135,0	616	8,12	-	-	-	-
160.4	5	502	89,1	590	12,26	468	107,1	575	9,74	444	117,8	562	8,54	413	130,3	544	7,35	377	144,3	521	6,22	350	160,1	510	5,37
	6	523	90,1	613	12,61	484	107,9	592	9,98	460	118,6	579	8,76	427	130,9	558	7,52	389	145,0	534	6,37	362	160,8	523	5,50
	7	540	90,8	630	12,88	498	108,6	607	10,18	474	119,3	594	8,95	442	131,6	573	7,71	402	145,6	547	6,52	371	161,3	533	5,60
	10	580	92,6	672	13,52	535	110,3	646	10,70	506	120,6	626	9,38	469	132,9	602	8,06	432	147,7	580	6,85	395	162,6	557	5,86
	15	647	95,9	742	14,48	600	113,3	713	11,59	568	123,3	692	10,21	531	136,2	668	8,80	488	150,2	639	7,50	-	-	-	-
	18	694	98,4	792	15,10	651	115,7	767	12,25	617	125,8	743	10,81	576	138,5	714	9,31	527	152,3	679	7,92	-	-	-	-
180.4	5	584	99,7	685	12,72	544	120,7	665	10,02	516	133,4	650	8,73	480	148,5	629	7,47	439	166,0	604	6,29	401	186,6	587	5,30
	6	603	100,1	704	13,05	561	121,1	682	10,27	532	133,8	666	8,96	495	148,8	644	7,66	453	166,4	618	6,44	412	186,8	597	5,40
	7	621	100,5	723	13,38	579	121,5	701	10,53	547	134,2	682	9,16	509	149,1	658	7,83	463	166,6	629	6,55	422	187,0	608	5,51
	10	663	101,4	765	14,08	613	122,4	736	11,02	581	135,0	716	9,61	538	149,8	688	8,18	489	167,3	655	6,84	446	187,5	633	5,75
	15	739	103,2	843	15,33	693	124,6	819	12,14	658	137,1	796	10,60	612	152,0	765	9,06	569	169,4	738	7,72	-	-	-	-
	18	801	104,5	907	16,34	747	126,0	874	12,87	710	138,6	849	11,25	666	153,4	820	9,68	609	170,8	780	8,14	-	-	-	-
200.4	5	635	110,2	746	12,54	592	132,8	725	9,92	562	146,7	709	8,67	522	162,8	685	7,42	478	181,6	659	6,26	438	203,5	640	5,30
	6	656	110,8	767	12,84	611	133,4	744	10,16	580	147,3	728	8,88	539	163,3	702	7,60	493	182,2	675	6,41	452	203,9	655	5,43
	7	676	111,4	788	13,14	629	134,1	764	10,39	598	147,9	747	9,10	556	163,8	720	7,79	505	182,5	687	6,53	463	204,3	666	5,53
	10	724	112,8	837	13,84	669	135,4	805	10,88	634	149,0	784	9,52	587	164,8	752	8,13	534	183,5	718	6,82	489	205,0	693	5,76
	15	803	115,4	919	14,92	746	138,0	885	11,82	707	151,4	859	10,35	662	167,5	829	8,90	615	186,4	802	7,60	-	-	-	-
	18	871	117,6	989	15,81	813	140,3	954	12,60	773	153,6	927	11,07	717	169,4	887	9,46	661	188,2	850	8,03	-	-	-	-

kWf = Cold user side cooling capacity (kW). The data do not consider the part related to the pumps, required to overcome the pressure drop for the solution circulation inside the exchangers
 kWt = Hot user side exchanger heating capacity (kW). The data do not consider the part related to the pumps, required to overcome the pressure drop for the solution circulation inside the exchangers.
 kWe = Compressor power input in kW
 Tw = Leaving water temperature cold user side
 GLE = Global Efficiency = (Cooling capacity + Heating capacity) / Total power input
 D.B. = Dry bulb
 W.B. = Wet bulb

Configuration for 4-pipe system

Acoustic configuration: compressor soundproofing (SC) / Acoustic configuration: super-silenced (EN)

Cooling 100% - Heating 100% performance

Size	Tw (°C)	Leaving water temperature hot user side																							
		20/25				30/35				35/40				40/45				45/50				50/55			
		kWf	kWe	kWt	GLE	kWf	kWe	kWt	GLE	kWf	kWe	kWt	GLE	kWf	kWe	kWt	GLE	kWf	kWe	kWt	GLE	kWf	kWe	kWt	GLE
220.4	5	710	121,9	833	12,66	661	147,4	809	9,98	627	162,9	790	8,70	581	181,2	762	7,41	528	202,6	729	6,20	484	227,7	710	5,24
	6	733	122,4	856	12,98	682	148,0	830	10,21	646	163,4	810	8,91	599	181,7	780	7,59	542	203,1	744	6,33	496	228,1	722	5,34
	7	755	122,9	878	13,28	699	148,6	848	10,41	663	163,9	827	9,08	612	182,0	794	7,72	555	203,5	758	6,45	507	228,3	733	5,43
	10	793	123,8	918	13,82	734	149,7	884	10,81	696	164,9	861	9,44	642	182,8	824	8,02	583	204,3	786	6,70	534	229,1	761	5,65
	15	887	126,5	1015	15,03	826	152,5	979	11,84	788	167,7	956	10,40	733	185,8	919	8,89	675	207,4	882	7,51	-	-	-	-
	18	961	128,5	1090	15,96	897	154,7	1053	12,61	850	169,6	1020	11,03	792	187,5	980	9,45	726	209,2	935	7,94	-	-	-	-
240.4	5	768	130,9	899	12,74	720	159,1	880	10,06	684	175,9	860	8,78	634	196,0	830	7,47	577	219,5	796	6,25	527	247,4	772	5,25
	6	792	131,3	924	13,07	743	159,6	903	10,31	701	176,3	877	8,95	654	196,4	851	7,66	595	219,9	814	6,40	540	247,7	786	5,35
	7	816	131,8	949	13,40	762	160,1	923	10,52	722	176,9	900	9,17	670	196,7	866	7,81	608	220,2	828	6,52	553	247,8	800	5,46
	10	863	132,6	996	14,02	801	161,1	963	10,95	761	177,8	939	9,56	704	197,5	901	8,12	640	221,0	861	6,79	584	248,3	831	5,70
	15	956	134,6	1092	15,21	893	163,3	1057	11,94	846	179,9	1026	10,40	790	199,7	990	8,92	734	223,1	957	7,58	-	-	-	-
	18	1036	136,4	1174	16,21	971	165,1	1137	12,77	923	181,9	1106	11,15	861	201,4	1062	9,55	794	224,9	1019	8,06	-	-	-	-

kWf = Cold user side cooling capacity (kW). The data do not consider the part related to the pumps, required to overcome the pressure drop for the solution circulation inside the exchangers
 kWt = Hot user side exchanger heating capacity (kW). The data do not consider the part related to the pumps, required to overcome the pressure drop for the solution circulation inside the exchangers.
 kWe = Compressor power input in kW
 Tw = Leaving water temperature cold user side
 GLE = Global Efficiency = (Cooling capacity + Heating capacity) / Total power input
 D.B. = Dry bulb
 W.B. = Wet bulb

Cold user side exchanger pressure drops

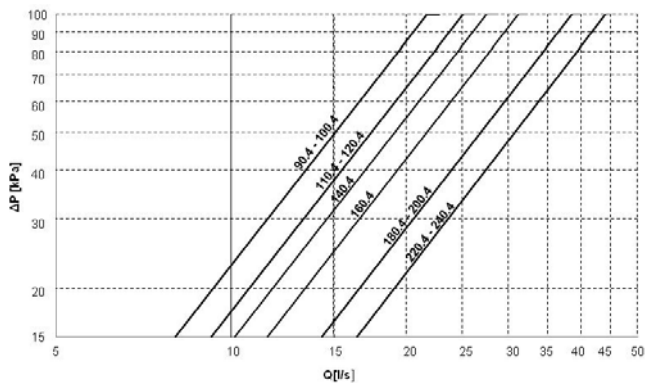

Hot user side exchanger pressure drops

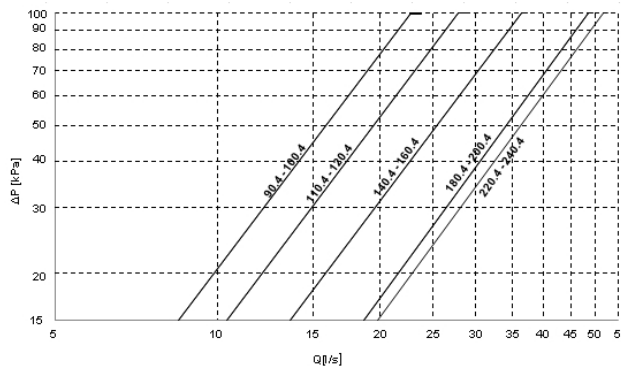

The pressure drops are calculated considering a water temperature of 7°C

Q = water flow-rate [l/s]
 DP = water side pressure drops (kPa)

Q = water flow-rate [l/s]
 DP = water side pressure drops (kPa)

The water flow-rate must be calculated with the following formula

$$Q [l/s] = kWf / (4,186 \times DT)$$

kWf = cooling capacity in kW
 DT = different between entering/leaving water temperature



To the internal exchanger pressure drops must be added the pressure drops of the steel mesh mechanical strainer that must be placed on the water input line. It is a device compulsory for the correct unit operation, and it is available as Clivet option (see the HYDRONIC ASSEMBLY ACCESSORIES). If the mechanical filter is selected and installed by the Customer, it is forbidden the use of filters with the mesh pitch higher than 1,6 mm, because they can cause a bad unit operation and also its serious damaging.

Configuration for 4-pipe system

Acoustic configuration: compressor soundproofing (SC)

Cooling performance at part load

Size	STEP	External exchanger entering air temperature (°C)											
		35			30			25			20		
		kWf	kWe_tot	EER	kWf	kWe_tot	EER	kWf	kWe_tot	EER	kWf	kWe_tot	EER
90.4	6	259	88	2,95	279	81	3,45	296	74	3,98	309	68	4,53
	5	226	73	3,08	243	67	3,60	258	62	4,15	269	57	4,73
	4	188	58	3,27	202	53	3,82	214	49	4,41	224	45	5,02
	3	144	43	3,32	155	40	3,89	165	37	4,49	172	34	5,11
	2	98	29	3,36	106	27	3,93	112	25	4,54	117	23	5,16
1	47	15	3,20	51	14	3,75	54	13	4,32	56	11	4,92	
100.4	6	275	95	2,89	296	88	3,38	315	80	3,93	329	74	4,48
	5	233	77	3,05	251	70	3,57	268	65	4,15	279	59	4,72
	4	187	57	3,31	202	52	3,87	215	48	4,50	224	44	5,13
	3	157	46	3,38	169	43	3,96	179	39	4,61	187	36	5,24
	2	124	36	3,45	133	33	4,04	142	30	4,70	148	28	5,35
1	59	18	3,27	64	17	3,83	68	15	4,45	71	14	5,07	
110.4	6	298	104	2,86	322	96	3,37	344	88	3,92	359	80	4,46
	5	247	81	3,05	267	74	3,60	285	68	4,18	297	62	4,76
	4	188	57	3,32	203	52	3,91	216	48	4,54	226	44	5,17
	3	171	50	3,38	184	46	3,98	197	42	4,63	205	39	5,27
	2	153	44	3,46	165	41	4,07	176	37	4,74	184	34	5,39
1	73	22	3,28	79	20	3,87	85	19	4,50	88	17	5,12	
120.4	4	340	118	2,88	369	108	3,43	393	99	3,98	410	91	4,53
	3	268	87	3,07	291	80	3,66	310	73	4,24	323	67	4,83
	2	192	55	3,47	209	50	4,14	222	46	4,80	232	42	5,47
	1	94	28	3,39	103	25	4,04	109	23	4,68	114	21	5,33
140.4	6	385	135	2,84	416	125	3,34	442	115	3,85	461	105	4,37
	5	316	104	3,03	342	96	3,56	364	89	4,10	380	81	4,67
	4	244	72	3,38	264	66	3,97	280	61	4,58	293	56	5,20
	3	222	64	3,44	240	59	4,05	255	55	4,66	266	50	5,30
	2	201	57	3,54	217	52	4,17	231	48	4,80	241	44	5,46
1	96	29	3,37	104	26	3,97	111	24	4,56	115	22	5,19	
160.4	4	434	150	2,90	471	137	3,43	499	128	3,91	522	117	4,45
	3	341	111	3,09	371	101	3,66	393	94	4,17	410	86	4,74
	2	243	71	3,42	264	65	4,05	280	61	4,62	292	56	5,25
	1	120	36	3,34	130	33	3,96	138	30	4,52	144	28	5,14
180.4	6	503	173	2,90	546	159	3,44	584	146	4,01	610	134	4,57
	5	435	141	3,08	472	129	3,66	505	119	4,26	527	109	4,85
	4	372	109	3,40	404	100	4,04	432	92	4,70	451	84	5,35
	3	266	83	3,23	289	75	3,83	310	69	4,47	323	64	5,08
	2	212	58	3,66	230	53	4,34	246	49	5,06	257	45	5,76
1	96	29	3,33	104	26	3,95	111	24	4,60	116	22	5,24	
200.4	6	545	188	2,91	588	173	3,39	628	160	3,92	655	147	4,45
	5	458	147	3,11	494	136	3,63	528	126	4,19	551	116	4,77
	4	371	107	3,45	400	99	4,03	427	92	4,65	446	84	5,29
	3	309	88	3,52	333	81	4,11	356	75	4,74	372	69	5,39
	2	258	70	3,70	278	64	4,32	297	60	4,99	310	55	5,66
1	128	35	3,67	139	32	4,28	148	30	4,94	154	28	5,61	
220.4	6	602	204	2,95	654	187	3,50	695	174	4,01	725	159	4,56
	5	510	165	3,08	553	151	3,66	588	140	4,20	614	129	4,77
	4	373	106	3,51	405	97	4,17	431	90	4,78	450	83	5,44
	3	313	86	3,62	340	79	4,30	362	73	4,93	377	67	5,60
	2	185	51	3,60	201	47	4,27	214	44	4,89	223	40	5,56
1	126	35	3,56	137	32	4,22	145	30	4,84	152	28	5,50	
240.4	4	650	224	2,90	707	204	3,46	748	191	3,92	781	175	4,46
	3	515	164	3,13	560	150	3,74	592	140	4,24	618	128	4,82
	2	386	104	3,70	420	95	4,42	445	89	5,01	464	81	5,70
	1	193	52	3,67	209	48	4,38	222	45	4,97	231	41	5,65

kWf = Cooling capacity in kW kWe_tot = Unit total power input in kW
 STEP = Active capacity steps (the maximum number indicates full capacity / the minimum number indicates the smallest partialization step)
 Internal exchanger water = output temperature 7°C / input * (variable) / constant flow equal to the nominal value.

Configuration for 4-pipe system

Acoustic configuration: super-silenced (EN)

Cooling performance at part load

Size	STEP	External exchanger entering air temperature (°C)											
		35			30			25			20		
		kWf	kWe_tot	EER	kWf	kWe_tot	EER	kWf	kWe_tot	EER	kWf	kWe_tot	EER
90.4	6	248	89	2,78	269	82	3,29	288	75	3,83	300	69	4,36
	5	219	74	2,96	237	67	3,51	253	62	4,09	264	57	4,66
	4	188	58	3,24	204	53	3,84	218	49	4,47	227	45	5,09
	3	144	44	3,30	156	40	3,91	167	37	4,55	174	34	5,18
	2	98	29	3,34	106	27	3,95	114	25	4,60	118	23	5,24
1	47	15	3,18	51	14	3,76	55	13	4,39	57	11	5,00	
100.4	6	263	96	2,73	286	88	3,24	306	81	3,79	319	74	4,31
	5	225	76	2,94	244	70	3,49	262	64	4,09	273	59	4,65
	4	187	56	3,34	203	51	3,97	218	47	4,64	227	43	5,28
	3	157	46	3,42	170	42	4,06	182	38	4,75	190	35	5,40
	2	124	36	3,48	134	32	4,14	144	30	4,84	150	27	5,51
1	59	18	3,30	64	16	3,92	69	15	4,58	72	14	5,21	
110.4	6	288	106	2,72	312	97	3,22	335	89	3,78	350	81	4,30
	5	238	81	2,93	258	74	3,47	277	68	4,07	289	62	4,63
	4	188	57	3,32	204	52	3,93	219	47	4,62	229	43	5,26
	3	171	50	3,39	185	46	4,01	199	42	4,71	208	39	5,36
	2	153	44	3,47	166	40	4,10	179	37	4,82	186	34	5,48
1	73	22	3,29	80	20	3,90	86	19	4,58	89	17	5,21	
120.4	4	326	122	2,67	354	111	3,19	378	102	3,70	394	94	4,21
	3	260	89	2,92	283	81	3,49	302	75	4,04	315	68	4,60
	2	193	56	3,43	210	51	4,09	224	47	4,75	234	43	5,40
	1	95	28	3,34	103	26	3,99	110	24	4,63	115	22	5,27
140.4	6	369	138	2,68	400	126	3,17	428	116	3,68	447	107	4,19
	5	307	105	2,92	333	96	3,46	356	89	4,01	371	81	4,56
	4	244	72	3,37	265	66	3,99	283	61	4,63	295	56	5,27
	3	222	65	3,43	241	59	4,07	258	55	4,72	269	50	5,37
	2	201	57	3,53	218	52	4,19	233	48	4,86	243	44	5,52
1	96	29	3,36	104	26	3,98	112	24	4,62	117	22	5,26	
160.4	4	413	152	2,72	450	139	3,23	483	128	3,77	504	118	4,28
	3	328	111	2,95	357	102	3,51	384	94	4,09	400	86	4,65
	2	243	71	3,43	265	65	4,08	285	60	4,76	297	55	5,42
	1	120	36	3,36	130	33	4,00	140	30	4,66	146	28	5,30
180.4	6	481	178	2,71	524	163	3,21	565	149	3,78	589	137	4,30
	5	418	144	2,91	455	132	3,45	491	121	4,07	512	111	4,63
	4	355	109	3,26	387	100	3,86	417	91	4,56	435	84	5,18
	3	254	82	3,10	277	75	3,67	299	69	4,33	311	63	4,92
	2	202	58	3,51	220	53	4,15	237	48	4,90	247	44	5,57
1	91	29	3,19	99	26	3,78	107	24	4,46	112	22	5,07	
200.4	6	524	191	2,75	563	176	3,19	600	162	3,70	627	149	4,20
	5	442	148	3,00	476	137	3,48	507	126	4,03	529	115	4,58
	4	361	105	3,43	388	97	3,99	414	90	4,61	432	82	5,25
	3	309	87	3,54	332	81	4,11	354	74	4,75	370	68	5,40
	2	258	69	3,71	277	64	4,32	295	59	4,99	308	54	5,68
1	128	35	3,68	138	32	4,28	147	30	4,95	154	27	5,63	
220.4	6	574	211	2,72	627	192	3,27	676	176	3,84	704	161	4,38
	5	490	168	2,91	535	153	3,50	577	140	4,11	601	129	4,68
	4	366	104	3,52	401	94	4,24	432	87	4,98	450	79	5,67
	3	313	86	3,63	343	78	4,37	369	72	5,13	385	66	5,84
	2	185	51	3,60	202	47	4,34	218	43	5,09	227	39	5,80
1	126	35	3,56	138	32	4,29	148	29	5,04	155	27	5,73	
240.4	4	618	235	2,63	675	213	3,16	727	196	3,71	758	179	4,22
	3	494	169	2,92	540	153	3,52	581	141	4,13	606	129	4,70
	2	371	104	3,58	406	94	4,32	437	86	5,06	455	79	5,76
	1	185	52	3,55	202	47	4,28	218	43	5,02	227	40	5,71

kWf = Cooling capacity in kW kWe_tot = Unit total power input in kW
 STEP = Active capacity steps (the maximum number indicates full capacity / the minimum number indicates the smallest partialization step)
 Internal exchanger water = output temperature 7°C / input * (variable) / constant flow equal to the nominal value.

Configuration for 4-pipe system

Acoustic configuration: compressor soundproofing (SC) / Acoustic configuration: super-silenced (EN)

Heating performance at part load

Size	STEP	Entering external exchanger air temperature (°C)																	
		-7/-8			-5/-6			-0/-1			2/1			7/6			12/11		
		kWt	kWe_tot	COP	kWt	kWe_tot	COP	kWt	kWe_tot	COP	kWt	kWe_tot	COP	kWt	kWe_tot	COP	kWt	kWe_tot	COP
90.4	6	215	66	3,26	227	67	3,41	258	68	3,82	272	68	4,00	311	69	4,50	361	71	5,11
	5	189	54	3,51	198	54	3,66	224	55	4,07	238	56	4,28	268	56	4,76	306	57	5,33
	4	157	42	3,72	165	42	3,88	188	43	4,34	198	44	4,55	225	44	5,08	256	45	5,68
	3	121	33	3,69	127	33	3,87	146	33	4,37	154	34	4,59	176	34	5,15	201	35	5,78
	2	84	23	3,64	89	23	3,85	104	24	4,41	110	24	4,64	127	24	5,27	147	25	5,97
	1	42	12	3,56	45	12	3,77	52	12	4,32	55	12	4,55	63	12	5,16	73	13	5,85
100.4	6	235	72	3,25	247	73	3,40	283	74	3,84	299	74	4,04	341	75	4,53	396	77	5,15
	5	207	59	3,53	217	59	3,68	246	60	4,10	260	60	4,31	294	61	4,78	335	62	5,36
	4	172	46	3,74	180	46	3,90	205	47	4,37	217	47	4,58	246	48	5,11	280	49	5,71
	3	132	36	3,71	139	36	3,89	160	36	4,39	169	37	4,61	192	37	5,18	220	38	5,81
	2	92	25	3,66	98	25	3,87	114	26	4,43	120	26	4,67	139	26	5,30	160	27	6,00
	1	46	13	3,58	49	13	3,79	57	13	4,34	60	13	4,57	69	13	5,19	80	14	5,88
110.4	6	258	78	3,30	271	79	3,44	310	80	3,88	327	80	4,07	371	82	4,54	430	83	5,15
	5	225	64	3,53	237	64	3,69	268	65	4,11	283	66	4,32	320	67	4,80	365	68	5,38
	4	187	50	3,75	197	50	3,91	224	51	4,38	236	51	4,59	268	52	5,12	305	53	5,72
	3	144	39	3,72	152	39	3,90	174	39	4,40	184	40	4,62	210	40	5,19	240	41	5,83
	2	100	27	3,67	107	27	3,88	124	28	4,45	131	28	4,68	151	28	5,31	175	29	6,02
	1	50	14	3,59	53	14	3,80	62	14	4,35	66	14	4,58	76	15	5,20	87	15	5,90
120.4	4	287	86	3,34	302	86	3,49	345	87	3,95	364	88	4,14	414	89	4,64	480	91	5,26
	3	219	64	3,42	231	64	3,59	265	65	4,07	280	66	4,27	321	67	4,81	367	68	5,39
	2	152	43	3,58	162	43	3,78	187	43	4,31	198	44	4,54	228	45	5,13	261	45	5,76
	1	76	22	3,51	81	22	3,70	94	22	4,22	99	22	4,44	114	23	5,03	131	23	5,65
140.4	6	325	97	3,36	341	98	3,50	389	99	3,92	410	100	4,10	467	102	4,58	540	105	5,16
	5	283	80	3,55	297	80	3,71	336	81	4,13	356	82	4,34	402	83	4,82	459	85	5,41
	4	236	62	3,77	247	63	3,93	281	64	4,40	297	64	4,62	337	65	5,15	383	67	5,76
	3	181	48	3,74	191	49	3,92	218	49	4,43	231	50	4,65	263	50	5,22	301	51	5,86
	2	126	34	3,69	134	34	3,90	156	35	4,47	165	35	4,71	190	36	5,34	220	36	6,05
	1	63	17	3,61	67	18	3,82	78	18	4,38	82	18	4,61	95	18	5,23	110	19	5,93
160.4	4	359	105	3,42	378	106	3,56	431	109	3,96	454	110	4,13	514	113	4,57	597	116	5,15
	3	272	81	3,37	288	81	3,55	330	82	4,02	348	82	4,22	399	84	4,76	456	86	5,33
	2	190	54	3,54	201	54	3,73	233	55	4,26	247	55	4,48	284	56	5,07	325	57	5,69
	1	95	27	3,47	101	27	3,66	116	28	4,17	123	28	4,39	142	29	4,97	163	29	5,58
180.4	6	417	125	3,34	437	126	3,48	494	128	3,87	522	129	4,05	590	131	4,51	683	133	5,15
	5	358	102	3,52	376	102	3,68	425	104	4,09	451	105	4,30	509	106	4,78	580	108	5,36
	4	298	80	3,74	313	80	3,90	356	82	4,37	376	82	4,58	426	83	5,11	485	85	5,71
	3	229	62	3,71	241	62	3,89	276	63	4,39	292	63	4,61	333	64	5,17	381	66	5,81
	2	160	44	3,66	170	44	3,87	197	44	4,43	209	45	4,67	241	45	5,30	278	46	6,00
	1	80	22	3,58	85	22	3,79	98	23	4,34	104	23	4,57	120	23	5,19	139	24	5,88
200.4	6	460	135	3,41	482	136	3,55	548	139	3,95	578	140	4,13	650	142	4,58	752	146	5,15
	5	394	111	3,55	414	112	3,71	469	114	4,13	496	114	4,34	560	116	4,82	639	118	5,40
	4	328	87	3,77	344	88	3,93	392	89	4,40	414	90	4,61	469	91	5,15	534	93	5,75
	3	252	67	3,74	265	68	3,92	304	69	4,42	322	69	4,65	367	70	5,22	420	72	5,86
	2	176	48	3,69	187	48	3,90	217	49	4,47	230	49	4,70	265	50	5,34	306	51	6,05
	1	88	24	3,61	93	24	3,82	108	25	4,37	115	25	4,60	132	25	5,23	153	26	5,92
220.4	6	497	148	3,36	520	149	3,49	590	152	3,88	623	153	4,07	700	156	4,49	807	159	5,08
	5	424	122	3,49	446	122	3,64	504	124	4,06	534	125	4,26	602	127	4,74	687	129	5,31
	4	353	95	3,70	370	96	3,86	422	97	4,32	445	98	4,53	505	100	5,06	574	102	5,65
	3	271	74	3,68	286	74	3,85	327	75	4,35	346	76	4,57	395	77	5,13	452	79	5,75
	2	189	52	3,63	201	52	3,83	233	53	4,39	247	53	4,62	285	54	5,25	329	55	5,94
	1	94	27	3,55	100	27	3,75	117	27	4,30	124	27	4,53	143	28	5,14	165	28	5,82
240.4	4	536	158	3,39	561	159	3,53	632	162	3,90	668	163	4,10	753	165	4,56	864	168	5,14
	3	397	119	3,35	420	119	3,52	482	121	3,99	508	122	4,18	583	124	4,72	666	126	5,28
	2	277	79	3,51	294	79	3,70	340	81	4,22	361	81	4,44	415	83	5,03	475	84	5,64
	1	139	40	3,44	147	41	3,63	170	41	4,13	180	41	4,35	207	42	4,93	237	43	5,53

kWt = Heating capacity in kW kWe_tot = Unit total power input in kW
 STEP = Active capacity steps (the maximum number indicates full capacity / the minimum number indicates the smallest partialization step)
 Internal exchanger water = output temperature 35°C / input * (variable) / constant flow equal to the nominal value.

2T configuration - For 2-pipe systems

2T configuration supply air conditioning systems with 2 tubes and it is able to supply hot water or chilled water dependently on season, with the total condensation heat recovery possibility. 2T configuration is designed for air conditioning systems, chilling and heating mode is defined depending on season and continuous changing modes are not allowed.

This configuration allows:

- Simultaneous free hot water production to the recovery side with chilled water production to the user side.
- Hot water production to the recovery side with cooling capacity rejection to the external thermal source.
- Chilled water production to the user side with heating capacity rejection to the external thermal source.
- Hot water production to the user side with cooling capacity rejection to the external thermal source.
- Simultaneous hot water production to the user side and to the recovery side (total heating capacity is the heating capacity declared within 'General technical data' section).

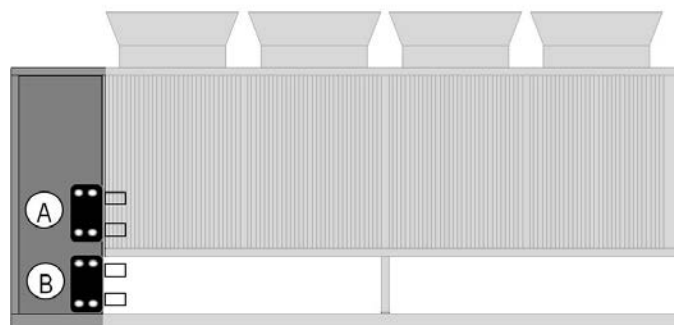

A: user side exchanger
B: recovery exchanger

Unit controller guarantees unit operation in mix mode conditions.

It is possible a priority set on request of recovery hot water (priority DHW). The hot water unit production request can be performed by a proper potential-free contact.

Considerations on the installation

Primary-secondary

The system must necessarily be provided with an hydraulic separator for primary-secondary both for the hot user side and for the cold user side. This allows the unit to effectively fulfil the load avoiding hysteresis of thermal shift. To monitor the secondary circuit load request, it is necessary to keep operating the primary circuit pump periodics, user and recovery side.

Suspension of hot load production

It is possible to inhibit the hot water production on hot user side and consequently the operation of the pumping unit connected to it through the appropriate potential free contact present in the electrical panel.

Desuperheater mode

The unit control, at part load, changes the water flow-rate, hot side, maintaining the temperature at the set-point. Through the flow modulation, the unit can produce hot water even over the set-point, up to a settable limit temperature (default 65°C). Thanks to this setting the exchanger operation time, hot user side, is extended in desuperheater mode, improving the unit efficiency of 5%.



The logic of control above described drives to a proper design of hydraulic components and safety devices, considering the upper limit of hot water. It is possible to decrease this temperature down to the set point, not having the energy efficiency benefits that desuperheater solution leads.

Operation with low water temperatures, recovery side

Depending on the outside air temperature, the recovery side set-point is automatically increased, by the unit control, to the minimum operation temperature indicated in the graph.

It is possible to maintain a recovery side temperature under the minimum limit indicated in the graph providing a primary-secondary. The secondary will be maintained at the desired temperature, the primary, managed by the unit, will have temperatures congruent to limits indicated in the graph.

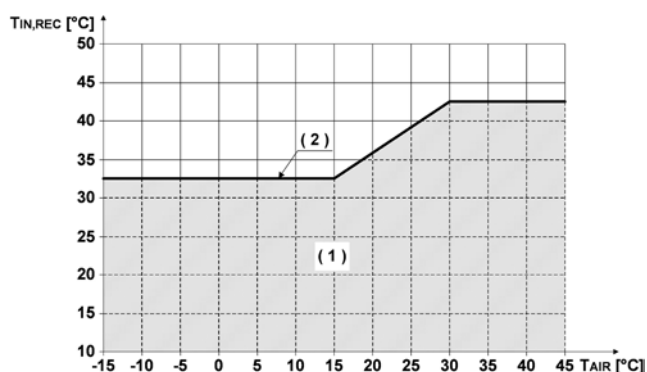

$T_{IN,REC}$ [°C] = entering water temperature to recovery
 T_{AIR} [°C] = entering external exchanger air temperature (D.B.)

1. Temporary operating range where unit forces the recovery set-point (if the hot load production is enabled)
2. Minimum system water temperature level, recovery side

Recovery side water flow-rate

If the pumping unit recovery side is not built-in installed, **the external pump start signal must be managed by the unit through the appropriate potential free contact present in the electrical panel.**

User side water flow-rate

For a proper unit operation is necessary to guarantee the user side water flow rate also when chilled water is not required. It is therefore necessary to maintain in stand-by and available at the start-up the primary circuit pumps also in the cold season.

If the pumping unit is not built-in installed, **the external pump start signal must be managed by the unit through the appropriate potential free contact present in the electrical panel.**

System water volume

For a proper unit operation is necessary to contemplate a correct design of water tanks both on user side and recovery side. Minimum system water volumes are described within 'General technical data' section and they have to be satisfied to avoid continuous compressor switching on and off. The values indicated guarantee: the operation stability and performance, the protection of all components subject to wear, the maintenance of the set-point even under the most extreme conditions of air conditioning (high heating capacity requests with low cooling capacity requests).

In the presence of a primary-secondary system, in the calculation of the minimum water flow rate volume it is possible to consider also the secondary volume only if it remains active (operating pumps) in all the load conditions.

Operation with outdoor air temperature lower than +5°C

If the system requires only hot load: the unit produces only hot water at recovery side with cool rejection on the external heat source.

If the system requires only cold load: the unit produces only chilled water at user side with heat rejection on the external heat source.

If the system requires simultaneously cold and hot load: the unit produces only chilled water at user side, and supply the user side with the desuperheating heat. The unit remains in chiller mode with partial recovery until the cold load is not fulfilled. Once fulfilled it, the unit switches to a only hot water production mode on the recovery side.

Process applications

For process applications with variable heat loads and constant set temperatures throughout the year, please contact Clivet's Technical Department to evaluate the most appropriate solution.

Configuration for 2-pipe system

Unit configuration

WSAN-XSC3 MF **200** . **4** **2T** **EXC** **SC** **AXIX** **=** **=**

(1) (2) (3) (4) (5) (6) (7) (8) (9)

(1) Range

WSAN = Air cooled heat pump with scroll compressor
XSC3 = SPINchiller³ range
MF = Multifunction

(2) Size

200 = Nominal compressor capacity (HP)

(3) Compressors

4 = Compressor quantity

(4) System configuration

2T = Configuration for 2-pipe systems with total recovery

(5) Energy efficiency

EXC = EXCELLENCE version: high energy efficiency

(6) Acoustic configuration

SC = Acoustic configuration with compressor soundproofing

EN = Super-silenced acoustic configuration

(7) Fan diffusers

AXIX - Diffuser for high efficiency fan (standard - separately supplied)

NAXI - Diffuser not required

(8) Pumping unit user side

(-) not required

2PM - Hydropack user side with no. 2 of ON/OFF pumps

3PM - Hydropack user side con no. 3 of ON/OFF pumps

2PMV - Hydropack user side with no. 2 of inverter pumps

3PMV - Hydropack user side with no. 3 of inverter pumps

(9) Pumping unit recovery side

(-) not required

HYGR2V - Hydropack recovery side with no. 2 of inverter pumps

HYGR3V - Hydropack recovery side with no. 3 of inverter pumps

Hydraulic side	Hydronic units		
USER SIDE Chilled water production or hot water production for installation	1.1 Standard unit 	1.2 Standard unit with HYDROPACK ON/OFF 	1.3 Standard unit with HYDROPACK activated by inverter
	2.1 Standard unit 		2.3 Standard unit with HYDROPACK activated by inverter

Accessories separately supplied

• **RCMRX** - Remote control via microprocessor remote control

• **PSX** - Mains power supply unit

• **AMMX** - Spring antivibration mounts

Configuration for 2-pipe system

Acoustic configuration: compressor soundproofing (SC)

General technical data - Performance

Size			90.4	100.4	110.4	120.4	140.4	160.4	180.4	200.4	220.4	240.4
Cooling												
Cooling capacity	1	[kW]	259	275	298	340	385	434	503	545	602	650
Compressor power input	1	[kW]	78,3	85,6	94,6	108	123	137	158	172	188	208
Total power input	2	[kW]	87,9	95,2	104	118	135	150	173	188	204	224
EER	1	-	2,95	2,89	2,86	2,88	2,84	2,90	2,90	2,91	2,95	2,90
SEER	9	-	4,16	4,14	4,13	4,16	4,16	4,13	4,24	4,24	4,22	4,16
Water flow-rate	1	[l/s]	12,4	13,1	14,3	16,3	18,4	20,7	24,0	26,0	28,8	31,1
User side exchanger pressure drops	1	[kPa]	34,3	38,3	33,9	43,4	46,1	45,6	40,0	46,7	43,8	50,9
Cooling capacity (EN14511:2013)	3	[kW]	258	274	297	339	383	433	502	543	600	648
Total power input (EN14511:2013)	3	[kW]	88,8	96,1	105	119	137	151	175	189	206	227
EER (EN 14511:2013)	3	-	2,91	2,85	2,82	2,84	2,80	2,86	2,87	2,87	2,91	2,86
ESEER (EN 14511:2013)	3	-	4,26	4,30	4,32	4,30	4,28	4,42	4,40	4,45	4,44	4,34
Cooling capacity (AHRI 550/590)	7	[kW]	258	273	297	339	382	432	502	544	600	648
Compressor power input (AHRI 550/590)	7	[kW]	78,2	85,6	94,5	108	122	136	157	171	188	208
Total power input (AHRI 550/590)	7	[kW]	87,8	95,2	104	118	134	149	172	187	204	224
COPr	7	-	2,94	2,87	2,86	2,87	2,85	2,90	2,92	2,91	2,94	2,89
IPLV	7	-	4,79	4,82	4,84	4,80	4,78	4,97	4,92	4,97	4,96	4,87
Heating												
Heating capacity	4	[kW]	282	311	338	376	424	469	541	598	643	693
Compressor power input	4	[kW]	77,8	86,0	94,0	104	116	130	151	166	184	198
Total power input	2	[kW]	87,3	95,6	104	114	129	143	167	182	199	214
COP	4	-	3,23	3,25	3,26	3,31	3,30	3,28	3,24	3,29	3,23	3,23
SCOP - AVERAGE Climate W35	9	-	3,80	3,81	3,82	3,72	3,85	3,71	-	-	-	-
Heating capacity (EN14511:2013)	5	[kW]	283	312	340	378	426	471	543	600	646	696
Total power input (EN14511:2013)	5	[kW]	88,5	97,1	105	115	131	145	169	184	202	217
COP (EN 14511:2013)	5	[kW]	3,20	3,22	3,22	3,28	3,26	3,25	3,22	3,25	3,20	3,20
Cooling 100% - Recovery 100%												
Cooling capacity	6	[kW]	255	275	305	344	397	442	509	556	612	670
Total recovery heating capacity	6	[kW]	331	357	396	447	513	573	658	720	794	866
Total power input	6	[kW]	76,6	82,6	91,2	103	117	132	150	164	183	197
Global efficiency	8	[kW]	7,65	7,64	7,69	7,66	7,76	7,68	7,80	7,76	7,70	7,79

The Product is compliant with the Erp (Energy Related Products) European Directive. It includes the Commission delegated Regulation (EU) No 811/2013 (rate heat output ≤ 70 kW at specified reference conditions) and the Commission delegated Regulation (EU) No 813/2013 (rated heat output ≤ 400 kW at specified reference conditions).

Contains fluorinated greenhouse gase (GWP 2087,5)

1. Data referred to the following conditions: internal exchanger water = 12/7 °C. Entering external exchanger air temperature 35°C. Internal exchanger fouling factor = 0.44×10^{-4} m² K/W.
2. The Total Power Input value does not take into account the part related to the pumps and required to overcome the pressure drops for the circulation of the solution inside the exchangers
3. Data compliant to Standard EN 14511:2013 referred to the following conditions: - Internal exchanger water temperature = 12/7°C - Entering external exchanger air temperature = 35°C.
4. Data referred to the following conditions: internal exchanger water = 40/45 °C. Entering external exchanger air temperature = 7°C D.B./6°C W.B. Internal exchanger fouling factor = 0.44×10^{-4} m² K/W
5. Data compliant to Standard EN 14511:2013 referred to the following conditions: - Internal exchanger water temperature = 40/45 °C. Entering external exchanger air temperature = 7°C D.B./6°C W.B.
6. Data referred to the following conditions: exchanger water cooling side = 12/7 °C. exchanger water heating side = 40/45°C. Exchanger fouling factor = 0.44×10^{-4} m² K/W
7. Data compliant to Standard AHRI 550/590 referred to the following conditions: internal exchanger water temperature = 6,7 °C. Water flow-rate 0,043 l/s per kW. Entering external exchanger air temperature 35°C. Internal exchanger fouling factor = 0.18×10^{-4} m² K/W
8. Global Efficiency = (Cooling capacity + Heating capacity) / Total power input
9. Data calculated according to the EN 14825:2016 Regulation

Configuration for 2-pipe system

Acoustic configuration: super-silenced (EN)

General technical data - Performance

Size			90.4	100.4	110.4	120.4	140.4	160.4	180.4	200.4	220.4	240.4
Cooling												
Cooling capacity	1	[kW]	248	263	288	326	369	413	481	524	574	618
Compressor power input	1	[kW]	82,4	89,3	98,6	115	129	143	166	179	199	224
Total power input	2	[kW]	89,4	96,3	106	122	138	152	178	191	211	235
EER	1	-	2,78	2,73	2,72	2,67	2,68	2,72	2,71	2,75	2,72	2,63
SEER	9	-	4,13	4,11	4,11	4,09	4,12	4,10	4,16	4,15	4,14	4,14
Water flow-rate	1	[l/s]	11,9	12,6	13,7	15,6	17,6	19,7	23,0	25,0	27,4	29,5
User side exchanger pressure drops	1	[kPa]	31,6	35,2	31,6	39,9	42,5	41,5	36,7	43,3	39,9	46,0
Cooling capacity (EN14511:2013)	3	[kW]	248	262	287	307	367	412	479	522	572	616
Total power input (EN14511:2013)	3	[kW]	90,2	97,2	107	123	139	153	179	192	213	237
EER (EN 14511:2013)	3	-	2,74	2,70	2,69	2,50	2,65	2,68	2,68	2,72	2,69	2,60
ESEER (EN 14511:2013)	3	-	4,16	4,26	4,24	4,24	4,19	4,29	4,22	4,30	4,30	4,21
Cooling capacity (AHRI 550/590)	7	[kW]	247	262	286	325	367	411	480	522	572	616
Compressor power input (AHRI 550/590)	7	[kW]	82,2	89,1	98,4	115	128	142	166	179	199	223
Total power input (AHRI 550/590)	7	[kW]	89,2	96,1	106	122	137	151	178	191	211	234
COPr	7	-	2,77	2,73	2,70	2,66	2,68	2,72	2,70	2,73	2,71	2,63
IPLV	7	-	4,65	4,78	4,74	4,75	4,68	4,78	4,71	4,83	4,82	4,73
Heating												
Heating capacity	4	[kW]	282	311	338	376	424	469	541	598	643	693
Compressor power input	4	[kW]	77,8	86,0	94,0	104	116	130	151	166	184	198
Total power input	2	[kW]	87,3	95,6	104	114	129	143	167	182	199	214
COP	4	-	3,23	3,25	3,26	3,31	3,30	3,28	3,24	3,29	3,23	3,23
SCOP - AVERAGE Climate W35	9	-	3,80	3,81	3,82	3,72	3,85	3,71	-	-	-	-
Heating capacity (EN14511:2013)	5	[kW]	283	312	340	378	426	471	543	600	646	696
Total power input (EN14511:2013)	5	[kW]	88,5	97,1	105	115	131	145	169	184	202	217
COP (EN 14511:2013)	5	[kW]	3,20	3,22	3,22	3,28	3,26	3,25	3,22	3,25	3,20	3,20
Cooling 100% - Recovery 100%												
Cooling capacity	6	[kW]	255	275	305	344	397	442	509	556	612	670
Total recovery heating capacity	6	[kW]	331	357	396	447	513	573	658	720	794	866
Total power input	6	[kW]	76,6	82,6	91,2	103	117	132	150	164	183	197
Global efficiency	8	[kW]	7,65	7,64	7,69	7,66	7,76	7,68	7,80	7,76	7,70	7,79

The Product is compliant with the Erp (Energy Related Products) European Directive. It includes the Commission delegated Regulation (EU) No 811/2013 (rate heat output ≤ 70 kW at specified reference conditions) and the Commission delegated Regulation (EU) No 813/2013 (rated heat output ≤ 400 kW at specified reference conditions).

Contains fluorinated greenhouse gase (GWP 2087,5)

1. Data referred to the following conditions: internal exchanger water = 12/7 °C. Entering external exchanger air temperature 35°C. Internal exchanger fouling factor = 0.44×10^{-4} m² K/W.
2. The Total Power Input value does not take into account the part related to the pumps and required to overcome the pressure drops for the circulation of the solution inside the exchangers
3. Data compliant to Standard EN 14511:2013 referred to the following conditions: - Internal exchanger water temperature = 12/7°C - Entering external exchanger air temperature = 35°C.
4. Data referred to the following conditions: internal exchanger water = 40/45 °C. Entering external exchanger air temperature = 7°C D.B./6°C W.B. Internal exchanger fouling factor = 0.44×10^{-4} m² K/W
5. Data compliant to Standard EN 14511:2013 referred to the following conditions: - Internal exchanger water temperature = 40/45 °C. Entering external exchanger air temperature = 7°C D.B./6°C W.B.
6. Data referred to the following conditions: exchanger water cooling side = 12/7 °C. exchanger water heating side = 40/45°C. Exchanger fouling factor = 0.44×10^{-4} m² K/W
7. Data compliant to Standard AHRI 550/590 referred to the following conditions: internal exchanger water temperature = 6,7 °C. Water flow-rate 0,043 l/s per kW. Entering external exchanger air temperature 35°C. Internal exchanger fouling factor = 0.18×10^{-4} m² K/W
8. Global Efficiency = (Cooling capacity + Heating capacity) / Total power input
9. Data calculated according to the EN 14825:2016 Regulation

Configuration for 2-pipe system

Acoustic configuration: compressor soundproofing (SC)

General technical data - Construction

Size			90.4	100.4	110.4	120.4	140.4	160.4	180.4	200.4	220.4	240.4
Compressor												
Type of compressors		-	Scroll	Scroll	Scroll	Scroll	Scroll	Scroll	Scroll	Scroll	Scroll	Scroll
Refrigerant		[kg]	R-410A	R-410A	R-410A	R-410A	R-410A	R-410A	R-410A	R-410A	R-410A	R-410A
No. of compressors		No	4	4	4	4	4	4	4	4	4	4
Rated power (C1)		[HP]	45	50	55	60	70	80	90	100	100	120
Rated power (C2)		[HP]	45	50	55	60	70	80	90	100	120	120
Std Capacity control steps		No	6	6	6	4	6	4	6	6	5	4
Oil charge (C1)		[l]	10	11	13	13	13	13	13	13	13	13
Oil charge (C2)		[l]	10	11	13	13	13	13	13	13	13	13
Refrigerant charge (C1)	1	[kg]	47	47	47	57	64	65	79	79	81	95
Refrigerant charge (C2)	1	[kg]	44	44	44	53	60	61	74	74	89	89
Refrigeration circuits		No	2	2	2	2	2	2	2	2	2	2
Internal exchanger												
Type of cold user side exchanger	2	-	PHE	PHE	PHE	PHE	PHE	PHE	PHE	PHE	PHE	PHE
Type of hot user side exchanger	2	-	PHE	PHE	PHE	PHE	PHE	PHE	PHE	PHE	PHE	PHE
Cold user side exchanger water content		[l]	24	24	29	29	32	37	49	49	62	62
Hot user side exchanger water content		[l]	14,4	14,4	18,0	18,0	25,2	25,2	43,2	43,2	54,0	54,0
User side minimum system water content	3	[l]	3307	3511	3805	4938	4915	6303	6422	6958	7686	9439
Recovery side minimum system water content	3	[l]	2601	2875	3130	4106	3924	5115	5000	5529	5952	7568
External Section Fans												
Type of fans	4	-	AX	AX	AX	AX	AX	AX	AX	AX	AX	AX
Number of fans		No	6	6	6	6	8	8	10	10	10	10
Type of motor	5	-	AC/P	AC/P	AC/P	AC/P	AC/P	AC/P	AC/P	AC/P	AC/P	AC/P
Standard airflow		[l/s]	37357	37357	36797	36365	49807	49063	62677	61219	60854	60489
Connections												
User side water fittings		-	4"	4"	4"	4"	4"	5"	5"	5"	5"	5"
Recovery side water fittings		-	4"	4"	4"	4"	4"	5"	5"	5"	5"	5"
Power supply												
Standard power supply		V	400/3~/50	400/3~/50	400/3~/50	400/3~/50	400/3~/50	400/3~/50	400/3~/50	400/3~/50	400/3~/50	400/3~/50
Electrical data												
FLA - Total		A	205,2	216,5	233,3	262,1	299,3	328,3	387,9	416,9	457,1	497,3
FLI - Total		kW	117,7	128,6	138,2	155,8	180,7	201,9	231,2	252,4	275,8	299,2
M.I.C. - Value	6	A	455,6	466,9	483,7	512,5	619,2	648,2	657,6	686,6	726,8	767,0
M.I.C. - with soft start accessory	6	A	317,8	329,1	345,9	374,7	447,2	476,2	657,6	686,6	726,8	767,0

- Indicative values for standard units with possible +/-10% variation. The actual data are indicated on the label of the unit.
- PHE = Plate exchanger
- Water volume necessary for the proper unit operation (for more details see 'Considerations on the application')
- AX = axial fan
- AC/P = asynchronous three-phase external rotor motor with phase cutting speed automatic control

Unbalance between phase max 2% Voltage variation: max +/- 10%
 Electrical data refer to standard units; according to the installed accessories, the data can suffer some variations.
 6. M.I.C.=Maximum unit starting current. The M.I.C. value is obtained adding the max. compressor starting current of the highest size to the power input at max. admissible conditions (F.L.A.) of the remaining electric components.

Sound levels

Size	Sound power level (dB)								Sound power level dB(A)	Sound pressure level dB(A)
	Octave band (Hz)									
	63	125	250	500	1000	2000	4000	8000		
90.4	93	90	90	88	88	85	71	62	92	72
100.4	93	90	90	88	88	85	71	62	92	72
110.4	93	90	90	88	88	85	71	62	92	72
120.4	93	90	90	88	88	85	71	62	92	72
140.4	94	91	91	89	89	86	72	63	92	72
160.4	95	92	92	90	90	87	73	64	93	73
180.4	101	97	96	93	89	84	78	72	95	74
200.4	101	97	96	93	89	84	78	72	95	74
220.4	102	98	97	94	90	85	79	73	95	74
240.4	102	98	97	94	90	85	79	73	95	75

The sound levels refer to standard unit with Axitop (no accessories) at full load, in test nominal conditions. The sound pressure level refers to 1 m. from the standard unit outer surface operating in open field.
 Measures are according to UNI EN ISO 9614-2 regulations, with respect to the EUROVENT 8/1 certification, which provides for a tolerance of 3 dB(A) on the sound power level, which is the only acoustic data to be considered binding.
 If unit is set without Axitop, the sound power level presents an increase up to 3 dB(A).

Data referred to the following conditions.
 - internal exchanger water = 12/7 °C
 - Ambient temperature = 35 °C

Configuration for 2-pipe system

Acoustic configuration: super-silenced (EN)

General technical data - Construction

Size			90.4	100.4	110.4	120.4	140.4	160.4	180.4	200.4	220.4	240.4
Compressor												
Type of compressors		-	Scroll	Scroll	Scroll	Scroll	Scroll	Scroll	Scroll	Scroll	Scroll	Scroll
Refrigerant		[kg]	R-410A	R-410A	R-410A	R-410A	R-410A	R-410A	R-410A	R-410A	R-410A	R-410A
No. of compressors		No	4	4	4	4	4	4	4	4	4	4
Rated power (C1)		[HP]	45	50	55	60	70	80	90	100	100	120
Rated power (C2)		[HP]	45	50	55	60	70	80	90	100	120	120
Std Capacity control steps		No	6	6	6	4	6	4	6	6	5	4
Oil charge (C1)		[l]	10	11	13	13	13	13	13	13	13	13
Oil charge (C2)		[l]	10	11	13	13	13	13	13	13	13	13
Refrigerant charge (C1)	1	[kg]	47	47	47	57	64	65	79	79	81	95
Refrigerant charge (C2)	1	[kg]	44	44	44	53	60	61	74	74	89	89
Refrigeration circuits		No	2	2	2	2	2	2	2	2	2	2
Internal exchanger												
Type of cold user side exchanger	2	-	PHE	PHE	PHE	PHE	PHE	PHE	PHE	PHE	PHE	PHE
Type of hot user side exchanger	2	-	PHE	PHE	PHE	PHE	PHE	PHE	PHE	PHE	PHE	PHE
Cold user side exchanger water content		[l]	24	24	29	29	32	37	49	49	62	62
Hot user side exchanger water content		[l]	14,4	14,4	18,0	18,0	25,2	25,2	43,2	43,2	54,0	54,0
User side minimum system water content	3	[l]	3307	3511	3805	4938	4915	6303	6422	6958	7686	9439
Recovery side minimum system water content	3	[l]	2601	2875	3130	4106	3924	5115	5000	5529	5952	7568
External Section Fans												
Type of fans	4	-	AX	AX	AX	AX	AX	AX	AX	AX	AX	AX
Number of fans		No	6	6	6	6	8	8	10	10	10	10
Type of motor	5	-	AC/P	AC/P	AC/P	AC/P	AC/P	AC/P	AC/P	AC/P	AC/P	AC/P
Standard airflow		[l/s]	30588	30588	29943	29570	40784	39924	50870	49776	49467	49159
Connections												
User side water fittings		-	4"	4"	4"	4"	4"	5"	5"	5"	5"	5"
Recovery side water fittings		-	4"	4"	4"	4"	4"	5"	5"	5"	5"	5"
Power supply												
Standard power supply		V	400/3~/50	400/3~/50	400/3~/50	400/3~/50	400/3~/50	400/3~/50	400/3~/50	400/3~/50	400/3~/50	400/3~/50
Electrical data												
FLA - Total		A	205,2	216,5	233,3	262,1	299,3	328,3	387,9	416,9	457,1	497,3
FLI - Total		kW	117,7	128,6	138,2	155,8	180,7	201,9	231,2	252,4	275,8	299,2
M.I.C. - Value	6	A	455,6	466,9	483,7	512,5	619,2	648,2	657,6	686,6	726,8	767,0
M.I.C. - with soft start accessory	6	A	317,8	329,1	345,9	374,7	447,2	476,2	657,6	686,6	726,8	767,0

- Indicative values for standard units with possible +/-10% variation. The actual data are indicated on the label of the unit.
- PHE = Plate exchanger
- Water volume necessary for the proper unit operation (for more details see 'Considerations on the application')
- AX = axial fan
- AC/P = asynchronous three-phase external rotor motor with phase cutting speed automatic control

Unbalance between phase max 2 % Voltage variation: max +/- 10%
 Electrical data refer to standard units; according to the installed accessories, the data can suffer some variations.
 6. M.I.C.=Maximum unit starting current. The M.I.C. value is obtained adding the max. compressor starting current of the highest size to the power input at max. admissible conditions (F.L.A.) of the remaining electric components.

Sound levels

Size	Sound power level (dB)								Sound power level dB(A)	Sound pressure level dB(A)
	Octave band (Hz)									
	63	125	250	500	1000	2000	4000	8000		
90.4	87	84	84	82	82	79	65	56	86	66
100.4	87	84	84	82	82	79	65	56	86	66
110.4	87	84	84	82	82	79	65	56	86	66
120.4	88	85	85	83	83	80	66	57	86	66
140.4	88	85	85	83	83	80	66	57	86	66
160.4	89	86	86	84	84	81	67	58	87	67
180.4	96	92	91	88	84	79	73	67	90	69
200.4	96	92	91	88	84	79	73	67	90	69
220.4	97	93	92	89	85	80	74	68	90	69
240.4	97	93	92	89	85	80	74	68	90	70

The sound levels refer to standard unit with Axitop (no accessories) at full load, in test nominal conditions. The sound pressure level refers to 1 m. from the standard unit outer surface operating in open field. Measures are according to UNI EN ISO 9614-2 regulations, with respect to the EUROVENT 8/1 certification, which provides for a tolerance of 3 dB(A) on the sound power level, which is the only acoustic data to be considered binding.

If unit is set without Axitop, the sound power level presents an increase up to 3 dB(A).

Data referred to the following conditions.

- internal exchanger water = 12/7 °C
- Ambient temperature = 35 °C

The indicated sound levels are only valid within the operating field of the standard unit at full load as indicated in the 'Operating range - cooling' graph in the "Super-silenced EN" configuration. With outdoor air temperatures the unit operates at full load automatically increasing the airflow and taking the same sound levels of the "Soundproofed Compressors SC" configuration.

Configuration for 2-pipe system

Operating range in cooling

Compressor soundproofing (SC)

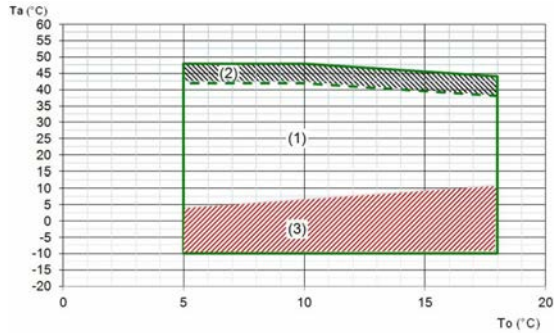

Ta (°C) = external exchanger inlet air temperature (D.B.)
To (°C) = internal exchanger outlet water temperature

1. Standard unit operating range at full load
2. Unit operating range with automatic staging of the compressor capacity
3. Standard unit operating range with air flow automatic modulation

Super-silenced (EN)

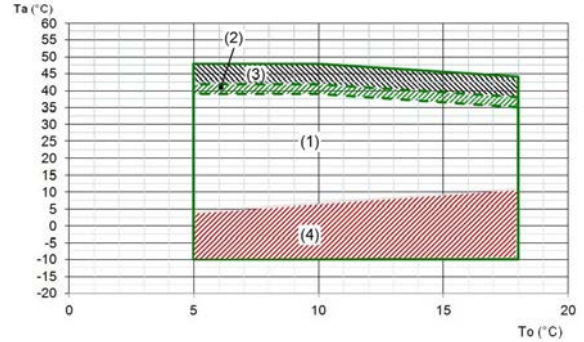

Ta (°C) = external exchanger inlet air temperature (D.B.)
To (°C) = internal exchanger outlet water temperature

1. Standard unit operating range at full load
2. Extended operating range with air flow-rate automatic increasing. Inside this field the sound levels are the same of the 'compressor soundproofing (SC)' acoustic configuration
3. Unit operating range with automatic staging of the compressor capacity
4. Standard unit operating range with air flow automatic modulation

Operating range in heating

Compressor soundproofing (SC) / Super-silenced (EN)

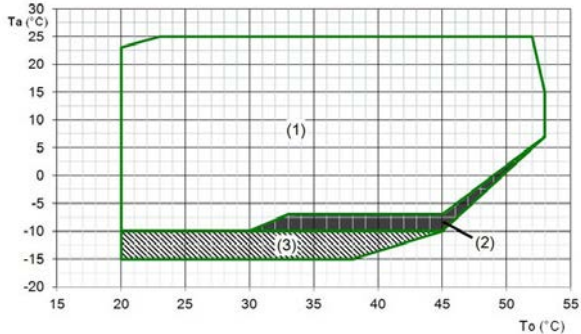

Ta (°C) = external exchanger inlet air temperature (D.B.)
To (°C) = internal exchanger outlet water temperature

1. Standard unit operating range at full load
2. Unit operating range with 'OHE' - operating range extension kit up to -10°C (W.B.)
3. Range in which the unit operation is allowed only for a limited period (max 1 hour).

Operating range - Cooling 100% - Recovery 100%

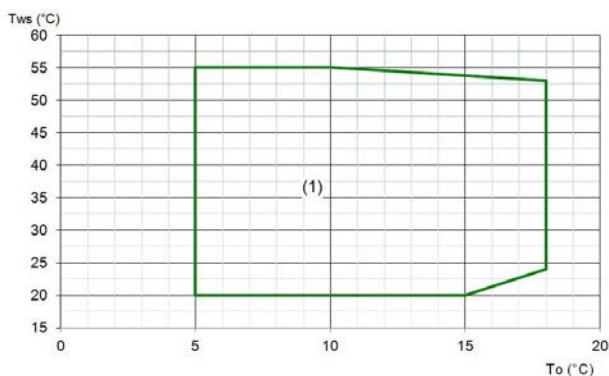

Tws (°C) = leaving recovery side exchanger water temperature
To (°C) = leaving user side exchanger water temperature

1. The water-water mode is applied with outdoor air temperatures higher than 5°C. For lower temperatures the unit guarantees the hot and cold production alternating the chiller plus desuperheater operation, recovery only

Configuration for 2-pipe system

Admissible water flow-rates

Minimum (Qmin) and maximum (Qmax) admissible water flow for the unit to operate correctly.

User side exchanger

EXCELLENCE SC/EN		90.4	100.4	110.4	120.4	140.4	160.4	180.4	200.4	220.4	240.4
Qmin	[l/s]	8,0	8,0	9,3	9,3	10,1	11,5	14,3	14,3	16,4	16,4
Qmax	[l/s]	21,8	21,8	25,1	25,1	27,5	31,2	38,6	38,6	44,0	44,0

Recovery exchanger

EXCELLENCE SC/EN		90.4	100.4	110.4	120.4	140.4	160.4	180.4	200.4	220.4	240.4
Qmin	[l/s]	8,5	8,5	10,4	10,4	13,6	13,6	18,6	18,6	19,2	19,8
Qmax	[l/s]	22,7	22,7	22,7	22,7	36,3	36,3	48,3	48,3	49,8	51,4

Correction factors for glycol use

% ethylene glycol by weight		5%	10%	15%	20%	25%	30%	35%	40%
Freezing temperature	°C	-2,0	-3,9	-6,5	-8,9	-11,8	-15,6	-19,0	-23,4
Safety temperature	°C	3,0	1,0	-1,0	-4,0	-6,0	-10,0	-14,0	-19,0
Cooling Capacity Factor	Nr	0,997	0,994	0,99	0,986	0,981	0,976	0,970	0,964
Compressor power input Factor	Nr	1,000	1,001	1,001	1,001	1,001	1,002	1,002	1,002
Internal exchanger glycol solution flow factor	Nr	1,003	1,010	1,020	1,033	1,05	1,072	1,095	1,124
Pressure drop Factor	Nr	0,989	0,983	0,979	0,980	0,984	0,993	1,004	1,020

The correction factors shown refer to water and glycol ethylene mixes used to prevent the formation of frost on the exchangers in the water circuit during inactivity in winter.

Fouling Correction Factors

m ² K / W	Internal exchanger	
	F1	FK1
0.44 x 10 (-4)	1,0	1,0
0.88 x 10 (-4)	0,97	0,99
1.76 x 10 (-4)	0,94	0,98

F1 = Cooling capacity correction factors

FK1 = Compressor power input correction factor

Overload and control device calibrations

		open	closed	value
High pressure safety pressure switch	[kPa]	4050	3300	-
Antifreeze protection	[°C]	4	5.5	-
High pressure safety valve	[kPa]	-	-	4500
Low pressure safety valve	[kPa]	-	-	2950
Max no. of compressor starts per hour	[n°]	-	-	10
High compressor discharge temperature safety thermostat	[°C]	-	-	140

Exchanger operating range

	Internal exchanger	
	DPr	DPw
PED (CE)	4500	1000

DPr = Maximum operating pressure on refrigerant side in kPa

DPw = Maximum operating pressure on water side in kPa

Configuration for 2-pipe system

Acoustic configuration: compressor soundproofing (SC)

Cooling performance

(continued)

Size	To (°C)	ENTERING EXTERNAL EXCHANGER AIR TEMPERATURE (°C)											
		25		30		35		40		42		48	
		kWf	kWe	kWf	kWe	kWf	kWe	kWf	kWe	kWf	kWe	kWf	kWe
90.4	5	279	63.6	262	70.1	244	77.0	222	85.6	214	90.8	74.7	28.3
	6	287	64.3	270	70.5	252	77.8	228	87.6	220	91.1	77.0	28.4
	7	296	64.7	279	71.3	259	78.3	234	87.7	227	91.3	79.3	28.5
	10	316	66.1	298	72.7	274	79.9	249	88.8	243	92.5	85.0	28.8
	15	355	69.1	331	75.3	307	83.2	284	92.1	175	48.5	-	-
	18	381	70.9	356	77.7	331	85.2	305	95.5	192	49.6	-	-
100.4	5	295	69.7	279	76.3	260	84.7	237	94.5	228	98.2	95.8	36.3
	6	307	70.2	289	77.1	266	85.5	244	96.0	236	99.6	98.9	36.9
	7	315	70.6	296	77.9	275	85.6	248	97.4	244	101	102	37.4
	10	337	72.3	317	79.4	291	87.8	266	98.6	260	105	109	38.9
	15	374	75.7	351	82.7	326	91.0	304	102	203	61.1	-	-
	18	412	77.9	388	85.4	357	93.9	336	107	227	63.2	-	-
110.4	5	325	76.0	304	84.3	283	93.2	257	105	248	111	146	61.7
	6	336	77.2	315	85.2	290	94.1	265	106	257	111	151	61.7
	7	344	78.0	322	86.0	298	94.6	272	106	265	112	156	62.4
	10	369	79.6	345	87.7	318	96.2	288	109	277	116	163	64.6
	15	409	82.7	382	91.2	354	99.9	332	115	198	60.9	-	-
	18	451	85.4	422	93.2	388	103	370	119	223	62.3	-	-
120.4	5	368	87.6	348	95.9	321	106	294	118	284	124	150	61.2
	6	379	88.3	357	96.9	332	107	305	119	294	126	155	61.9
	7	393	89.0	369	97.9	340	108	311	121	300	128	158	62.8
	10	419	90.5	391	99.9	360	110	329	123	317	131	167	64.4
	15	469	94.7	438	104	404	115	378	128	211	58.7	-	-
	18	508	98.0	479	107	443	118	416	134	231	59.6	-	-
140.4	5	416	100	391	110	362	121	334	134	320	142	154	59.5
	6	427	101	402	111	373	121	345	134	333	143	160	60.0
	7	442	102	416	112	385	123	354	136	341	144	164	60.5
	10	471	105	441	114	405	125	375	138	363	149	174	62.8
	15	519	109	487	119	452	130	429	148	260	78.3	-	-
	18	575	113	534	123	498	134	475	154	292	80.2	-	-
160.4	5	471	112	445	122	411	134	374	150	359	160	191	79.9
	6	483	113	456	123	423	135	385	151	372	160	197	80.1
	7	499	115	471	125	434	137	396	152	385	162	204	80.6
	10	526	118	495	127	458	139	419	154	413	165	219	82.1
	15	588	123	548	133	510	146	471	160	276	73.9	-	-
	18	645	127	607	137	562	151	519	163	305	75.0	-	-
180.4	5	554	127	519	141	479	155	438	175	425	182	160	60.7
	6	573	129	535	142	495	157	448	176	436	184	164	61.2
	7	584	130	546	143	503	158	457	176	444	185	167	61.6
	10	613	133	572	145	527	160	492	181	466	190	175	63.3
	15	686	139	639	152	591	166	550	189	376	117	-	-
	18	744	143	690	156	640	171	593	194	416	119	-	-

kWf = Cooling capacity in kW. The data do not consider the part related to the pumps, required to overcome the pressure drop for the solution circulation inside the exchangers

kWe = Compressor power input in kW

To (°C) = leaving internal exchanger water temperature (°C) - Performances in function of the inlet/outlet water temperature differential = 5°C

Configuration for 2-pipe system

Acoustic configuration: compressor soundproofing (SC)

Cooling performance

Size	To (°C)	ENTERING EXTERNAL EXCHANGER AIR TEMPERATURE (°C)											
		25		30		35		40		42		48	
		kWf	kWe	kWf	kWe	kWf	kWe	kWf	kWe	kWf	kWe	kWf	kWe
200.4	5	596	141	559	154	519	169	480	185	469	192	287	119
	6	611	143	574	156	536	170	496	187	482	193	295	119
	7	628	145	588	157	545	172	506	188	493	194	302	120
	10	656	148	616	160	569	175	529	190	517	198	317	122
	15	722	155	684	169	638	183	600	199	399	112	-	-
	18	793	160	744	174	695	188	656	205	441	114	-	-
220.4	5	665	155	626	170	576	187	524	209	508	219	286	119
	6	682	157	642	171	590	188	537	209	518	222	292	121
	7	695	158	654	171	602	188	546	211	528	226	297	123
	10	727	160	679	174	626	192	566	218	559	233	315	127
	15	811	168	758	182	701	201	653	231	401	122	-	-
	18	878	173	819	188	760	206	722	235	444	125	-	-
240.4	5	716	171	675	187	623	207	562	227	549	242	287	118
	6	734	173	693	188	637	208	578	229	561	246	293	120
	7	748	175	707	188	650	208	594	232	572	249	299	122
	10	785	176	734	192	676	212	613	240	607	259	317	127
	15	872	184	813	200	757	220	705	255	404	116	-	-
	18	929	190	866	208	808	227	768	258	434	118	-	-

kWf = Cooling capacity in kW. The data do not consider the part related to the pumps, required to overcome the pressure drop for the solution circulation inside the exchangers

kWe = Compressor power input in kW

To (°C) = leaving internal exchanger water temperature (°C) - Performances in function of the inlet/outlet water temperature differential = 5°C

Configuration for 2-pipe system

Acoustic configuration: super-silenced (EN)

Cooling performance

(continued)

Size	To (°C)	ENTERING EXTERNAL EXCHANGER AIR TEMPERATURE (°C)											
		25		30		35		39		42		48	
		kWf	kWe	kWf	kWe	kWf	kWe	kWf	kWe	kWf	kWe	kWf	kWe
90.4	5	271	66.6	254	73.4	236	81.0	218	88.7	214	90.8	74.7	28.3
	6	280	67.3	263	74.2	242	81.8	225	89.8	220	91.1	77.0	28.4
	7	288	68.0	269	74.9	248	82.4	230	90.4	227	91.4	79.3	28.5
	10	308	69.5	287	76.3	264	84.2	246	91.3	243	92.5	85.0	28.8
	15	344	72.7	319	79.8	298	87.8	276	94.2	175	48.5	-	-
	18	366	75.2	344	82.4	316	90.8	295	95.9	190	49.6	-	-
100.4	5	288	72.2	269	79.5	249	87.6	229	97.0	228	98.2	95.8	36.3
	6	296	72.9	277	79.9	256	88.4	238	97.1	236	99.6	98.9	36.9
	7	306	73.7	286	81.1	263	89.3	244	98.0	244	101	102	37.4
	10	325	75.7	304	82.8	279	91.2	261	100	260	105	109	38.9
	15	362	79.2	339	86.4	315	95.4	291	104	203	61.1	-	-
	18	395	81.3	367	89.2	342	98.8	314	106	227	63.2	-	-
110.4	5	314	80.4	295	87.7	271	97.2	251	108	248	111	146	61.7
	6	325	81.0	303	88.5	279	97.7	261	108	257	111	151	61.7
	7	335	81.6	312	89.9	288	98.6	263	109	265	112	156	62.4
	10	357	83.4	332	91.2	304	101	282	111	277	116	163	64.6
	15	396	86.8	369	95.5	341	107	318	115	198	60.9	-	-
	18	433	89.4	404	98.4	374	109	349	117	224	62.3	-	-
120.4	5	357	92.6	334	102	308	113	289	123	284	124	150	61.2
	6	369	94.1	346	103	319	114	298	124	294	126	155	61.9
	7	378	95.1	354	104	326	115	305	126	300	128	158	62.8
	10	402	97.5	375	107	345	117	324	129	317	131	167	64.4
	15	447	102	418	111	387	124	362	134	211	58.7	-	-
	18	488	105	451	115	420	126	390	137	230	59.6	-	-
140.4	5	404	104	380	115	351	126	328	137	320	142	153	59.5
	6	419	106	391	116	360	127	339	139	333	143	160	60.0
	7	428	107	400	117	369	129	344	141	341	144	164	60.5
	10	454	110	424	120	390	131	363	147	362	149	174	62.8
	15	504	116	469	126	438	139	413	154	260	78.3	-	-
	18	551	119	516	130	482	143	454	158	292	80.2	-	-
160.4	5	456	116	425	127	393	140	369	153	359	160	191	79.9
	6	468	117	439	129	404	141	380	154	372	160	197	80.1
	7	483	119	450	130	413	143	385	156	385	162	204	80.6
	10	509	122	472	133	434	146	401	160	413	165	219	82.1
	15	563	128	524	140	486	155	456	166	276	73.9	-	-
	18	608	133	567	144	524	159	494	170	306	75.0	-	-
180.4	5	536	136	500	149	463	163	426	182	425	182	160	60.7
	6	552	137	513	151	473	165	435	183	436	184	164	61.2
	7	565	138	524	152	481	166	445	184	444	185	167	61.6
	10	592	141	548	154	505	169	472	186	466	190	175	63.3
	15	658	148	612	162	568	178	518	191	376	117	-	-
	18	704	152	656	166	610	184	550	196	413	119	-	-

kWf = Cooling capacity in kW. The data do not consider the part related to the pumps, required to overcome the pressure drop for the solution circulation inside the exchangers

kWe = Compressor power input in kW

To (°C) = leaving internal exchanger water temperature (°C) - Performances in function of the inlet/outlet water temperature differential = 5°C

Configuration for 2-pipe system

Acoustic configuration: super-silenced (EN)

Cooling performance

Size	To (°C)	ENTERING EXTERNAL EXCHANGER AIR TEMPERATURE (°C)											
		25		30		35		39		42		48	
		kWf	kWe	kWf	kWe	kWf	kWe	kWf	kWe	kWf	kWe	kWf	kWe
200.4	5	576	148	539	161	500	176	472	189	469	192	287	119
	6	590	150	551	163	512	177	485	191	482	193	295	119
	7	600	151	563	165	524	179	495	192	493	194	302	120
	10	631	155	589	168	548	183	518	195	517	198	317	122
	15	695	163	653	177	614	192	589	206	399	112	-	-
	18	754	168	705	182	667	198	636	210	441	114	-	-
220.4	5	647	161	602	177	551	196	510	218	512	219	288	119
	6	662	163	615	179	564	198	520	221	522	222	294	121
	7	676	164	627	180	574	199	531	220	532	226	299	123
	10	705	167	653	183	595	203	561	227	564	233	317	127
	15	783	176	726	192	670	215	613	237	404	122	-	-
	18	847	181	789	198	729	223	656	242	444	125	-	-
240.4	5	695	181	646	198	594	219	549	245	551	242	288	118
	6	711	183	661	200	607	221	561	249	564	246	294	120
	7	727	184	675	202	618	224	574	249	575	249	300	122
	10	758	187	702	205	641	227	602	254	609	259	318	127
	15	837	196	776	214	718	240	660	264	406	116	-	-
	18	906	202	846	222	787	246	710	270	435	118	-	-

kWf = Cooling capacity in kW. The data do not consider the part related to the pumps, required to overcome the pressure drop for the solution circulation inside the exchangers

kWe = Compressor power input in kW

To (°C) = leaving internal exchanger water temperature (°C) - Performances in function of the inlet/outlet water temperature differential = 5°C

Configuration for 2-pipe system

Acoustic configuration: compressor soundproofing (SC) / Acoustic configuration: super-silenced (EN)

Heating performance

(continued)

Size	Ta (°C) D.B./W.B.	LEAVING INTERNAL EXCHANGER WATER TEMPERATURE (°C)									
		35		40		45		50		53	
		kWt	kWe	kWt	kWe	kWt	kWe	kWt	kWe	kWt	kWe
90.4	-7/-8	205	60.8	203	67.8	201	75.4	-	-	-	-
	-5/-6	216	61.2	214	68.0	211	75.6	-	-	-	-
	0/-1	245	62.4	243	68.9	238	76.2	-	-	-	-
	2/1	260	62.8	256	69.4	250	76.7	244	85.5	-	-
	7/6	297	64.1	290	70.7	282	77.8	273	86.6	272	91.7
	12/11	344	65.7	255	57.8	174	47.9	313	88.4	312	93.5
100.4	-7/-8	225	67.4	223	75.0	219	83.2	-	-	-	-
	-5/-6	236	67.8	235	75.2	231	83.5	-	-	-	-
	0/-1	270	68.9	268	76.3	262	84.4	-	-	-	-
	2/1	285	69.3	282	76.8	276	84.9	270	95.0	-	-
	7/6	325	70.6	319	78.1	311	86.0	303	96.4	302	102
	12/11	378	72.4	367	79.9	357	87.8	347	98.4	346	104
110.4	-7/-8	246	73.8	244	81.8	240	90.7	-	-	-	-
	-5/-6	258	74.3	256	82.2	252	91.1	-	-	-	-
	0/-1	295	75.5	291	83.4	286	92.2	-	-	-	-
	2/1	311	76.0	307	84.0	300	92.7	292	103	-	-
	7/6	354	77.4	346	85.5	338	94.0	330	105	327	111
	12/11	410	79.3	399	87.4	388	95.8	377	107	375	113
120.4	-7/-8	273	82.2	271	91.3	269	101	-	-	-	-
	-5/-6	287	82.6	284	91.5	282	102	-	-	-	-
	0/-1	329	83.7	323	92.6	317	102	-	-	-	-
	2/1	347	84.2	340	93.1	334	103	327	115	-	-
	7/6	394	85.7	386	94.7	376	104	365	116	365	123
	12/11	457	87.9	445	96.9	432	106	418	119	419	126
140.4	-7/-8	310	90.8	309	100	305	111	-	-	-	-
	-5/-6	325	91.5	324	101	319	112	-	-	-	-
	0/-1	371	93.3	367	103	362	114	-	-	-	-
	2/1	391	94.1	386	104	379	114	370	127	-	-
	7/6	445	96.3	435	106	424	116	416	130	414	137
	12/11	515	99.2	502	109	487	119	476	133	474	140
160.4	-7/-8	342	99.4	339	110	335	121	-	-	-	-
	-5/-6	360	101	356	111	350	122	-	-	-	-
	0/-1	410	103	403	114	395	125	-	-	-	-
	2/1	432	105	425	115	415	127	407	140	-	-
	7/6	490	107	480	118	469	130	457	143	455	151
	12/11	569	111	554	122	539	133	524	147	520	155
180.4	-7/-8	398	117	395	131	389	147	-	-	-	-
	-5/-6	417	118	415	132	409	147	-	-	-	-
	0/-1	471	120	470	134	460	149	-	-	-	-
	2/1	497	121	492	134	483	149	473	167	-	-
	7/6	563	123	554	136	541	151	529	169	526	180
	12/11	651	126	637	139	618	153	603	171	598	182

kWt = Internal exchanger heating capacity (kW). The data do not consider the part related to the pumps, required to overcome the pressure drop for the solution circulation inside the exchangers.

The kWt heating capacity does not consider any defrosting cycles. For the real heating capacity calculation, including defrosting cycles, please refer to "Integrated heating capacities" table.

kWe = Compressor power input in kW

Ta = Entering external exchanger air temperature

D.B. = Dry bulb

W.B. = Wet bulb

With Ta below -5°C OHE - Limit extension kit in heating accessory included.

Configuration for 2-pipe system

Acoustic configuration: compressor soundproofing (SC) / Acoustic configuration: super-silenced (EN)

Heating performance

Size	Ta (°C) D.B./W.B.	LEAVING INTERNAL EXCHANGER WATER TEMPERATURE (°C)									
		35		40		45		50		53	
		kWt	kWe	kWt	kWe	kWt	kWe	kWt	kWe	kWt	kWe
200.4	-7 / -8	439	128	436	142	427	158	-	-	-	-
	-5 / -6	460	129	457	144	449	159	-	-	-	-
	0 / -1	522	132	517	146	506	162	-	-	-	-
	2 / 1	551	133	543	147	533	163	521	182	-	-
	7 / 6	620	136	611	150	598	166	581	185	578	196
	12 / 11	717	139	701	154	684	169	662	188	657	199
220.4	-7 / -8	473	142	470	158	460	177	-	-	-	-
	-5 / -6	495	143	494	159	484	178	-	-	-	-
	0 / -1	563	146	555	162	545	180	-	-	-	-
	2 / 1	593	147	584	163	573	181	558	203	-	-
	7 / 6	667	150	658	166	643	184	627	206	622	219
	12 / 11	769	154	754	170	733	187	713	209	706	222
240.4	-7 / -8	510	153	506	171	494	191	-	-	-	-
	-5 / -6	534	154	530	172	520	192	-	-	-	-
	0 / -1	602	157	600	175	585	194	-	-	-	-
	2 / 1	636	158	629	176	615	196	602	220	-	-
	7 / 6	716	161	705	179	693	198	672	222	669	237
	12 / 11	823	164	807	182	787	201	765	225	759	239

kWt = Internal exchanger heating capacity (kW). The data do not consider the part related to the pumps, required to overcome the pressure drop for the solution circulation inside the exchangers.

The kWt heating capacity does not consider any defrosting cycles. For the real heating capacity calculation, including defrosting cycles, please refer to "Integrated heating capacities" table.

kWe = Compressor power input in kW

Ta = Entering external exchanger air temperature

D.B. = Dry bulb

W.B. = Wet bulb

With Ta below -5°C OHE - Limit extension kit in heating' accessory included.

Integrated heating capacities

Entering external exchanger air temperature °C (D.B. / W.B.)	-7 / -8	-5 / -6	0 / -1	2 / 1	Other
Heating capacity multiplication coefficient	0,90	0,89	0,88	0,90	1,00

The integrated heating capacity represents the real heating capacity considering the defrost cycles too.

To obtain the integrated heating capacity multiply the heating performance value in kWt (shown in the heating performance tables) by the coefficients indicated in the table.

DB = dry bulb

WB = wet bulb

In case of below zero outdoor air temperature with a long period of heat pump operating mode it is necessary to help the evacuation of the water produced during the defrost cycle; this to avoid the formation of ice in the unit basement. Pay attention that the evacuation will not create inconveniences to things or persons.

Configuration for 2-pipe system

Acoustic configuration: compressor soundproofing (SC) / Acoustic configuration: super-silenced (EN)

Cooling 100% - Recovery 100% performance

(continued)

Size	Tw (°C)	Leaving water temperature recovery side																							
		20/25				30/35				35/40				40/45				45/50				50/55			
		kWf	kWe	kWt	GLE	kWf	kWe	kWt	GLE	kWf	kWe	kWt	GLE	kWf	kWe	kWt	GLE	kWf	kWe	kWt	GLE	kWf	kWe	kWt	GLE
90.4	5	296	50,5	345	12,69	272	61,7	333	9,81	257	68,1	324	8,53	237	75,5	312	7,28	218	84,1	302	6,18	202	94,1	296	5,29
	6	305	50,7	355	13,03	281	61,9	342	10,05	265	68,4	333	8,75	247	75,8	323	7,52	226	84,5	310	6,35	209	94,4	303	5,43
	7	315	50,8	365	13,38	291	62,2	352	10,34	275	68,7	344	9,01	255	76,1	331	7,70	232	84,7	317	6,48	214	94,6	309	5,53
	10	342	51,3	392	14,28	314	62,8	376	10,96	297	69,3	366	9,55	273	76,7	350	8,12	249	85,5	334	6,81	230	95,2	325	5,83
	15	382	51,9	432	15,67	352	64,0	415	11,98	337	70,5	406	10,55	313	78,2	391	9,00	286	87,0	373	7,58	-	-	-	-
	18	415	52,3	465	16,82	383	64,8	447	12,81	362	71,2	433	11,16	338	79,2	417	9,54	308	88,0	396	8,00	-	-	-	-
100.4	5	316	54,7	370	12,54	291	66,4	357	9,76	276	73,3	349	8,53	257	81,6	339	7,30	234	91,2	326	6,14	217	102,4	320	5,25
	6	329	55,1	383	12,91	303	66,7	369	10,07	286	73,6	360	8,78	266	81,8	348	7,50	242	91,6	334	6,29	225	102,6	328	5,39
	7	339	55,4	393	13,21	312	67,0	379	10,31	294	73,8	368	8,97	275	82,1	357	7,69	250	91,9	342	6,45	232	102,9	336	5,52
	10	370	56,2	425	14,13	339	67,8	406	10,98	320	74,6	394	9,58	296	82,8	379	8,14	268	92,6	361	6,78	250	103,5	354	5,83
	15	414	57,5	470	15,37	382	69,3	450	12,02	362	75,9	437	10,54	335	84,3	419	8,93	308	94,2	402	7,54	-	-	-	-
	18	447	58,3	503	16,27	412	70,1	480	12,72	392	76,9	468	11,19	365	85,5	450	9,52	333	95,3	428	7,99	-	-	-	-
110.4	5	352	60,7	411	12,58	325	73,5	398	9,84	309	81,2	390	8,60	284	90,0	375	7,32	262	100,4	363	6,22	241	112,5	354	5,29
	6	363	61,0	423	12,90	336	73,7	409	10,11	319	81,5	400	8,83	297	90,4	387	7,57	271	100,7	372	6,38	249	112,8	363	5,43
	7	375	61,3	435	13,22	347	74,0	420	10,36	329	81,8	411	9,05	305	90,7	396	7,73	279	101,0	381	6,54	258	113,1	371	5,56
	10	407	62,1	467	14,08	377	74,8	451	11,06	354	82,5	436	9,57	328	91,3	419	8,18	299	101,7	401	6,89	276	113,6	391	5,87
	15	457	63,4	518	15,38	424	76,2	499	12,10	400	83,8	483	10,54	373	92,9	466	9,04	344	103,2	447	7,66	-	-	-	-
	18	493	64,4	555	16,27	457	77,2	533	12,83	435	84,9	519	11,24	403	93,8	497	9,59	372	104,3	476	8,13	-	-	-	-
120.4	5	398	68,7	465	12,57	368	83,3	451	9,84	348	92,0	439	8,56	321	102,1	423	7,29	296	114,1	410	6,19	274	128,0	403	5,29
	6	412	69,1	479	12,90	381	83,6	464	10,10	358	92,3	450	8,76	333	102,5	436	7,51	306	114,5	421	6,35	283	128,3	412	5,41
	7	428	69,6	496	13,28	395	84,0	478	10,39	372	92,7	464	9,02	344	102,9	447	7,69	315	114,9	431	6,49	292	128,6	421	5,54
	10	462	70,5	531	14,09	423	84,7	507	10,97	400	93,5	493	9,55	370	103,8	474	8,13	341	116,5	457	6,85	311	129,2	441	5,82
	15	514	72,0	584	15,25	477	86,6	562	12,00	449	95,2	544	10,44	421	105,7	526	8,97	385	117,6	502	7,54	-	-	-	-
	18	556	73,0	627	16,21	515	87,7	601	12,73	489	96,4	585	11,14	455	107,0	562	9,50	415	119,1	534	7,97	-	-	-	-
140.4	5	453	78,6	531	12,52	420	94,8	514	9,85	399	104,5	504	8,64	372	115,8	488	7,43	343	128,7	472	6,33	312	143,2	456	5,36
	6	468	79,2	546	12,81	434	95,3	529	10,09	412	105,0	517	8,85	385	116,2	501	7,62	354	129,3	483	6,48	325	143,8	469	5,53
	7	486	79,9	565	13,17	450	95,9	545	10,38	426	105,5	531	9,07	397	116,7	513	7,80	362	129,6	492	6,59	334	144,2	478	5,63
	10	523	81,2	604	13,88	485	97,2	582	10,98	457	106,6	564	9,58	426	117,8	544	8,23	388	130,8	519	6,93	357	145,3	503	5,92
	15	582	83,4	664	14,94	542	99,5	640	11,89	514	108,6	622	10,45	483	120,3	603	9,02	445	133,3	578	7,67	-	-	-	-
	18	633	85,4	717	15,80	585	101,1	685	12,56	559	110,5	669	11,12	521	122,0	642	9,53	481	135,0	616	8,12	-	-	-	-
160.4	5	502	89,1	590	12,26	468	107,1	575	9,74	444	117,8	562	8,54	413	130,3	544	7,35	377	144,3	521	6,22	350	160,1	510	5,37
	6	523	90,1	613	12,61	484	107,9	592	9,98	460	118,6	579	8,76	427	130,9	558	7,52	389	145,0	534	6,37	362	160,8	523	5,50
	7	540	90,8	630	12,88	498	108,6	607	10,18	474	119,3	594	8,95	442	131,6	573	7,71	402	145,6	547	6,52	371	161,3	533	5,60
	10	580	92,6	672	13,52	535	110,3	646	10,70	506	120,6	626	9,38	469	132,9	602	8,06	432	147,7	580	6,85	395	162,6	557	5,86
	15	647	95,9	742	14,48	600	113,3	713	11,59	568	123,3	692	10,21	531	136,2	668	8,80	488	150,2	639	7,50	-	-	-	-
	18	694	98,4	792	15,10	651	115,7	767	12,25	617	125,8	743	10,81	576	138,5	714	9,31	527	152,3	679	7,92	-	-	-	-
180.4	5	584	99,7	685	12,72	544	120,7	665	10,02	516	133,4	650	8,73	480	148,5	629	7,47	439	166,0	604	6,29	401	186,6	587	5,30
	6	603	100,1	704	13,05	561	121,1	682	10,27	532	133,8	666	8,96	495	148,8	644	7,66	453	166,4	618	6,44	412	186,8	597	5,40
	7	621	100,5	723	13,38	579	121,5	701	10,53	547	134,2	682	9,16	509	149,1	658	7,83	463	166,6	629	6,55	422	187,0	608	5,51
	10	663	101,4	765	14,08	613	122,4	736	11,02	581	135,0	716	9,61	538	149,8	688	8,18	489	167,3	655	6,84	446	187,5	633	5,75
	15	739	103,2	843	15,33	693	124,6	819	12,14	658	137,1	796	10,60	612	152,0	765	9,06	569	169,4	738	7,72	-	-	-	-
	18	801	104,5	907	16,34	747	126,0	874	12,87	710	138,6	849	11,25	666	153,4	820	9,68	609	170,8	780	8,14	-	-	-	-
200.4	5	635	110,2	746	12,54	592	132,8	725	9,92	562	146,7	709	8,67	522	162,8	685	7,42	478	181,6	659	6,26	438	203,5	640	5,30
	6	656	110,8	767	12,84	611	133,4	744	10,16	580	147,3	728	8,88	539	163,3	702	7,60	493	182,2	675	6,41	452	203,9	655	5,43
	7	676	111,4	788	13,14	629	134,1	764	10,39	598	147,9	747	9,10	556	163,8	720	7,79	505	182,5	687	6,53	463	204,3	666	5,53
	10	724	112,8	837	13,84	669	135,4	805	10,88	634	149,0	784	9,52	587	164,8	752	8,13	534	183,5	718	6,82	489	205,0	693	5,76
	15	803	115,4	919	14,92	746	138,0	885	11,82	707	151,4	859	10,35	662	167,5	829	8,90	615	186,4	802	7,60	-	-	-	-
	18	871	117,6	989	15,81	813	140,3	954	12,60	773	153,6	927	11,07	717	169,4	887	9,46	661	188,2	850	8,03	-	-	-	-

kWf = Cold user side cooling capacity (kW). The data do not consider the part related to the pumps, required to overcome the pressure drop for the solution circulation inside the exchangers
 kWt = Hot user side exchanger heating capacity (kW). The data do not consider the part related to the pumps, required to overcome the pressure drop for the solution circulation inside the exchangers.
 kWe = Compressor power input in kW
 Tw = Leaving water temperature cold user side
 GLE = Global Efficiency = (Cooling capacity + Heating capacity) / Total power input
 D.B. = Dry bulb
 W.B. = Wet bulb

Configuration for 2-pipe system

Acoustic configuration: compressor soundproofing (SC) / Acoustic configuration: super-silenced (EN)

Cooling 100% - Recovery 100% performance

Size	Tw (°C)	Leaving water temperature recovery side																								
		20/25				30/35				35/40				40/45				45/50				50/55				
		kWf	kWe	kWt	GLE	kWf	kWe	kWt	GLE	kWf	kWe	kWt	GLE	kWf	kWe	kWt	GLE	kWf	kWe	kWt	GLE	kWf	kWe	kWt	GLE	
220.4	5	710	121,9	833	12,66	661	147,4	809	9,98	627	162,9	790	8,70	581	181,2	762	7,41	528	202,6	729	6,20	484	227,7	710	5,24	
	6	733	122,4	856	12,98	682	148,0	830	10,21	646	163,4	810	8,91	599	181,7	780	7,59	542	203,1	744	6,33	496	228,1	722	5,34	
	7	755	122,9	878	13,28	699	148,6	848	10,41	663	163,9	827	9,08	612	182,0	794	7,72	555	203,5	758	6,45	507	228,3	733	5,43	
	10	793	123,8	918	13,82	734	149,7	884	10,81	696	164,9	861	9,44	642	182,8	824	8,02	583	204,3	786	6,70	534	229,1	761	5,65	
	15	887	126,5	1015	15,03	826	152,5	979	11,84	788	167,7	956	10,40	733	185,8	919	8,89	675	207,4	882	7,51	-	-	-	-	-
	18	961	128,5	1090	15,96	897	154,7	1053	12,61	850	169,6	1020	11,03	792	187,5	980	9,45	726	209,2	935	7,94	-	-	-	-	-
240.4	5	768	130,9	899	12,74	720	159,1	880	10,06	684	175,9	860	8,78	634	196,0	830	7,47	577	219,5	796	6,25	527	247,4	772	5,25	
	6	792	131,3	924	13,07	743	159,6	903	10,31	701	176,3	877	8,95	654	196,4	851	7,66	595	219,9	814	6,40	540	247,7	786	5,35	
	7	816	131,8	949	13,40	762	160,1	923	10,52	722	176,9	900	9,17	670	196,7	866	7,81	608	220,2	828	6,52	553	247,8	800	5,46	
	10	863	132,6	996	14,02	801	161,1	963	10,95	761	177,8	939	9,56	704	197,5	901	8,12	640	221,0	861	6,79	584	248,3	831	5,70	
	15	956	134,6	1092	15,21	893	163,3	1057	11,94	846	179,9	1026	10,40	790	199,7	990	8,92	734	223,1	957	7,58	-	-	-	-	-
	18	1036	136,4	1174	16,21	971	165,1	1137	12,77	923	181,9	1106	11,15	861	201,4	1062	9,55	794	224,9	1019	8,06	-	-	-	-	-

kWf = Cold user side cooling capacity (kW). The data do not consider the part related to the pumps, required to overcome the pressure drop for the solution circulation inside the exchangers
 kWt = Hot user side exchanger heating capacity (kW). The data do not consider the part related to the pumps, required to overcome the pressure drop for the solution circulation inside the exchangers.
 kWe = Compressor power input in kW
 Tw = Leaving water temperature cold user side
 GLE = Global Efficiency = (Cooling capacity + Heating capacity) / Total power input
 D.B. = Dry bulb
 W.B. = Wet bulb

User side exchanger pressure drops

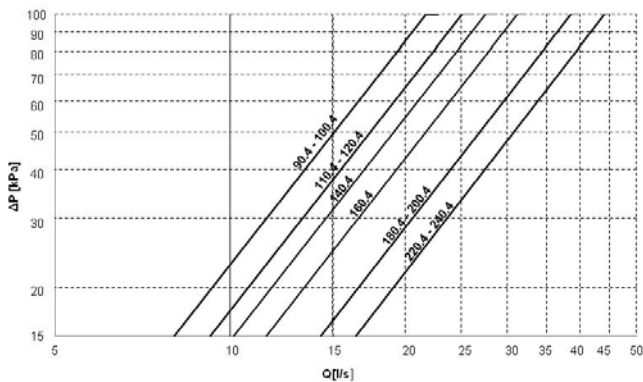

Recovery exchanger pressure drops

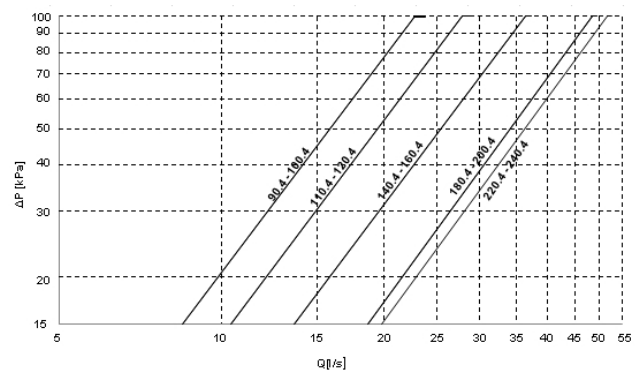

The pressure drops are calculated considering a water temperature of 7°C

Q = water flow-rate [l/s]
 DP = water side pressure drops (kPa)

The water flow-rate must be calculated with the following formula

$$Q [l/s] = kWf / (4,186 \times DT)$$

kWf = cooling capacity in kW
 DT = different between entering/leaving water temperature



To the internal exchanger pressure drops must be added the pressure drops of the steel mesh mechanical strainer that must be placed on the water input line. It is a device compulsory for the correct unit operation, and it is available as Clivet option (see the HYDRONIC ASSEMBLY ACCESSORIES). If the mechanical filter is selected and installed by the Customer, it is forbidden the use of filters with the mesh pitch higher than 1,6 mm, because they can cause a bad unit operation and also its serious damaging.

Configuration for 2-pipe system

Acoustic configuration: compressor soundproofing (SC)

Cooling performance at part load

Size	STEP	External exchanger entering air temperature (°C)											
		35			30			25			20		
		kWf	kWe_tot	EER	kWf	kWe_tot	EER	kWf	kWe_tot	EER	kWf	kWe_tot	EER
90.4	6	259	88	2,95	279	81	3,45	296	74	3,98	309	68	4,53
	5	226	73	3,08	243	67	3,60	258	62	4,15	269	57	4,73
	4	188	58	3,27	202	53	3,82	214	49	4,41	224	45	5,02
	3	144	43	3,32	155	40	3,89	165	37	4,49	172	34	5,11
	2	98	29	3,36	106	27	3,93	112	25	4,54	117	23	5,16
1	47	15	3,20	51	14	3,75	54	13	4,32	56	11	4,92	
100.4	6	275	95	2,89	296	88	3,38	315	80	3,93	329	74	4,48
	5	233	77	3,05	251	70	3,57	268	65	4,15	279	59	4,72
	4	187	57	3,31	202	52	3,87	215	48	4,50	224	44	5,13
	3	157	46	3,38	169	43	3,96	179	39	4,61	187	36	5,24
	2	124	36	3,45	133	33	4,04	142	30	4,70	148	28	5,35
1	59	18	3,27	64	17	3,83	68	15	4,45	71	14	5,07	
110.4	6	298	104	2,86	322	96	3,37	344	88	3,92	359	80	4,46
	5	247	81	3,05	267	74	3,60	285	68	4,18	297	62	4,76
	4	188	57	3,32	203	52	3,91	216	48	4,54	226	44	5,17
	3	171	50	3,38	184	46	3,98	197	42	4,63	205	39	5,27
	2	153	44	3,46	165	41	4,07	176	37	4,74	184	34	5,39
1	73	22	3,28	79	20	3,87	85	19	4,50	88	17	5,12	
120.4	4	340	118	2,88	369	108	3,43	393	99	3,98	410	91	4,53
	3	268	87	3,07	291	80	3,66	310	73	4,24	323	67	4,83
	2	192	55	3,47	209	50	4,14	222	46	4,80	232	42	5,47
	1	94	28	3,39	103	25	4,04	109	23	4,68	114	21	5,33
140.4	6	385	135	2,84	416	125	3,34	442	115	3,85	461	105	4,37
	5	316	104	3,03	342	96	3,56	364	89	4,10	380	81	4,67
	4	244	72	3,38	264	66	3,97	280	61	4,58	293	56	5,20
	3	222	64	3,44	240	59	4,05	255	55	4,66	266	50	5,30
	2	201	57	3,54	217	52	4,17	231	48	4,80	241	44	5,46
1	96	29	3,37	104	26	3,97	111	24	4,56	115	22	5,19	
160.4	4	434	150	2,90	471	137	3,43	499	128	3,91	522	117	4,45
	3	341	111	3,09	371	101	3,66	393	94	4,17	410	86	4,74
	2	243	71	3,42	264	65	4,05	280	61	4,62	292	56	5,25
	1	120	36	3,34	130	33	3,96	138	30	4,52	144	28	5,14
180.4	6	503	173	2,90	546	159	3,44	584	146	4,01	610	134	4,57
	5	435	141	3,08	472	129	3,66	505	119	4,26	527	109	4,85
	4	372	109	3,40	404	100	4,04	432	92	4,70	451	84	5,35
	3	266	83	3,23	289	75	3,83	310	69	4,47	323	64	5,08
	2	212	58	3,66	230	53	4,34	246	49	5,06	257	45	5,76
1	96	29	3,33	104	26	3,95	111	24	4,60	116	22	5,24	
200.4	6	545	188	2,91	588	173	3,39	628	160	3,92	655	147	4,45
	5	458	147	3,11	494	136	3,63	528	126	4,19	551	116	4,77
	4	371	107	3,45	400	99	4,03	427	92	4,65	446	84	5,29
	3	309	88	3,52	333	81	4,11	356	75	4,74	372	69	5,39
	2	258	70	3,70	278	64	4,32	297	60	4,99	310	55	5,66
1	128	35	3,67	139	32	4,28	148	30	4,94	154	28	5,61	
220.4	6	602	204	2,95	654	187	3,50	695	174	4,01	725	159	4,56
	5	510	165	3,08	553	151	3,66	588	140	4,20	614	129	4,77
	4	373	106	3,51	405	97	4,17	431	90	4,78	450	83	5,44
	3	313	86	3,62	340	79	4,30	362	73	4,93	377	67	5,60
	2	185	51	3,60	201	47	4,27	214	44	4,89	223	40	5,56
1	126	35	3,56	137	32	4,22	145	30	4,84	152	28	5,50	
240.4	4	650	224	2,90	707	204	3,46	748	191	3,92	781	175	4,46
	3	515	164	3,13	560	150	3,74	592	140	4,24	618	128	4,82
	2	386	104	3,70	420	95	4,42	445	89	5,01	464	81	5,70
	1	193	52	3,67	209	48	4,38	222	45	4,97	231	41	5,65

kWf = Cooling capacity in kW kWe_tot = Unit total power input in kW
 STEP = Active capacity steps (the maximum number indicates full capacity / the minimum number indicates the smallest partialization step)
 Internal exchanger water = output temperature 7°C / input * (variable) / constant flow equal to the max. step nominal value.

Configuration for 2-pipe system

Acoustic configuration: super-silenced (EN)

Cooling performance at part load

Size	STEP	External exchanger entering air temperature (°C)											
		35			30			25			20		
		kWf	kWe_tot	EER	kWf	kWe_tot	EER	kWf	kWe_tot	EER	kWf	kWe_tot	EER
90.4	6	248	89	2,78	269	82	3,29	288	75	3,83	300	69	4,36
	5	219	74	2,96	237	67	3,51	253	62	4,09	264	57	4,66
	4	188	58	3,24	204	53	3,84	218	49	4,47	227	45	5,09
	3	144	44	3,30	156	40	3,91	167	37	4,55	174	34	5,18
	2	98	29	3,34	106	27	3,95	114	25	4,60	118	23	5,24
1	47	15	3,18	51	14	3,76	55	13	4,39	57	11	5,00	
100.4	6	263	96	2,73	286	88	3,24	306	81	3,79	319	74	4,31
	5	225	76	2,94	244	70	3,49	262	64	4,09	273	59	4,65
	4	187	56	3,34	203	51	3,97	218	47	4,64	227	43	5,28
	3	157	46	3,42	170	42	4,06	182	38	4,75	190	35	5,40
	2	124	36	3,48	134	32	4,14	144	30	4,84	150	27	5,51
1	59	18	3,30	64	16	3,92	69	15	4,58	72	14	5,21	
110.4	6	288	106	2,72	312	97	3,22	335	89	3,78	350	81	4,30
	5	238	81	2,93	258	74	3,47	277	68	4,07	289	62	4,63
	4	188	57	3,32	204	52	3,93	219	47	4,62	229	43	5,26
	3	171	50	3,39	185	46	4,01	199	42	4,71	208	39	5,36
	2	153	44	3,47	166	40	4,10	179	37	4,82	186	34	5,48
1	73	22	3,29	80	20	3,90	86	19	4,58	89	17	5,21	
120.4	4	326	122	2,67	354	111	3,19	378	102	3,70	394	94	4,21
	3	260	89	2,92	283	81	3,49	302	75	4,04	315	68	4,60
	2	193	56	3,43	210	51	4,09	224	47	4,75	234	43	5,40
	1	95	28	3,34	103	26	3,99	110	24	4,63	115	22	5,27
140.4	6	369	138	2,68	400	126	3,17	428	116	3,68	447	107	4,19
	5	307	105	2,92	333	96	3,46	356	89	4,01	371	81	4,56
	4	244	72	3,37	265	66	3,99	283	61	4,63	295	56	5,27
	3	222	65	3,43	241	59	4,07	258	55	4,72	269	50	5,37
	2	201	57	3,53	218	52	4,19	233	48	4,86	243	44	5,52
1	96	29	3,36	104	26	3,98	112	24	4,62	117	22	5,26	
160.4	4	413	152	2,72	450	139	3,23	483	128	3,77	504	118	4,28
	3	328	111	2,95	357	102	3,51	384	94	4,09	400	86	4,65
	2	243	71	3,43	265	65	4,08	285	60	4,76	297	55	5,42
	1	120	36	3,36	130	33	4,00	140	30	4,66	146	28	5,30
180.4	6	481	178	2,71	524	163	3,21	565	149	3,78	589	137	4,30
	5	418	144	2,91	455	132	3,45	491	121	4,07	512	111	4,63
	4	355	109	3,26	387	100	3,86	417	91	4,56	435	84	5,18
	3	254	82	3,10	277	75	3,67	299	69	4,33	311	63	4,92
	2	202	58	3,51	220	53	4,15	237	48	4,90	247	44	5,57
1	91	29	3,19	99	26	3,78	107	24	4,46	112	22	5,07	
200.4	6	524	191	2,75	563	176	3,19	600	162	3,70	627	149	4,20
	5	442	148	3,00	476	137	3,48	507	126	4,03	529	115	4,58
	4	361	105	3,43	388	97	3,99	414	90	4,61	432	82	5,25
	3	309	87	3,54	332	81	4,11	354	74	4,75	370	68	5,40
	2	258	69	3,71	277	64	4,32	295	59	4,99	308	54	5,68
1	128	35	3,68	138	32	4,28	147	30	4,95	154	27	5,63	
220.4	6	574	211	2,72	627	192	3,27	676	176	3,84	704	161	4,38
	5	490	168	2,91	535	153	3,50	577	140	4,11	601	129	4,68
	4	366	104	3,52	401	94	4,24	432	87	4,98	450	79	5,67
	3	313	86	3,63	343	78	4,37	369	72	5,13	385	66	5,84
	2	185	51	3,60	202	47	4,34	218	43	5,09	227	39	5,80
1	126	35	3,56	138	32	4,29	148	29	5,04	155	27	5,73	
240.4	4	618	235	2,63	675	213	3,16	727	196	3,71	758	179	4,22
	3	494	169	2,92	540	153	3,52	581	141	4,13	606	129	4,70
	2	371	104	3,58	406	94	4,32	437	86	5,06	455	79	5,76
	1	185	52	3,55	202	47	4,28	218	43	5,02	227	40	5,71

kWf = Cooling capacity in kW kWe_tot = Unit total power input in kW
 STEP = Active capacity steps (the maximum number indicates full capacity / the minimum number indicates the smallest partialization step)
 Internal exchanger water = output temperature 7°C / input * (variable) / constant flow equal to the max. step nominal value

Configuration for 2-pipe system

Acoustic configuration: compressor soundproofing (SC) / Acoustic configuration: super-silenced (EN)

Heating performance at part load

Size	STEP	Entering external exchanger air temperature (°C)																	
		-7/-8			-5/-6			-0/-1			2/1			7/6			12/11		
		kWt	kWe_tot	COP	kWt	kWe_tot	COP	kWt	kWe_tot	COP	kWt	kWe_tot	COP	kWt	kWe_tot	COP	kWt	kWe_tot	COP
90.4	6	205	70	2,91	216	71	3,05	245	72	3,40	260	72	3,59	297	74	4,03	344	75	4,57
	5	180	58	3,10	189	58	3,24	214	59	3,61	226	60	3,79	255	61	4,21	291	62	4,72
	4	150	45	3,30	157	46	3,44	179	46	3,85	189	47	4,03	214	48	4,50	244	48	5,03
	3	115	35	3,27	121	35	3,43	139	36	3,87	147	36	4,06	167	37	4,56	192	37	5,12
	2	80	25	3,23	85	25	3,41	99	25	3,91	105	26	4,11	121	26	4,67	140	26	5,29
	1	40	13	3,16	43	13	3,34	49	13	3,82	52	13	4,03	60	13	4,57	70	13	5,18
100.4	6	225	77	2,92	236	77	3,05	270	79	3,44	285	79	3,61	325	80	4,05	378	82	4,61
	5	197	63	3,12	207	63	3,26	234	64	3,63	248	65	3,81	280	66	4,24	319	67	4,75
	4	164	49	3,31	172	50	3,46	196	51	3,87	207	51	4,06	234	52	4,53	267	53	5,06
	3	126	38	3,29	133	38	3,45	152	39	3,89	161	39	4,08	183	40	4,59	210	41	5,15
	2	88	27	3,24	93	27	3,43	108	28	3,93	115	28	4,13	132	28	4,69	153	29	5,32
	1	44	14	3,17	47	14	3,36	54	14	3,84	57	14	4,05	66	14	4,60	76	15	5,21
110.4	6	246	84	2,94	258	84	3,07	295	85	3,46	311	86	3,63	354	87	4,06	410	89	4,60
	5	214	68	3,13	225	69	3,27	255	70	3,64	270	71	3,82	305	72	4,25	347	73	4,76
	4	178	54	3,32	187	54	3,47	213	55	3,88	225	55	4,07	255	56	4,54	290	57	5,07
	3	137	42	3,30	144	42	3,46	165	42	3,90	175	43	4,10	200	43	4,60	228	44	5,16
	2	96	29	3,25	102	30	3,44	118	30	3,94	125	30	4,15	144	31	4,71	166	31	5,33
	1	48	15	3,18	51	15	3,37	59	15	3,86	62	15	4,06	72	16	4,61	83	16	5,22
120.4	4	273	92	2,97	287	92	3,11	329	94	3,52	347	94	3,69	394	96	4,12	457	98	4,68
	3	208	69	3,02	220	69	3,18	253	70	3,61	266	70	3,78	306	72	4,26	349	73	4,77
	2	145	46	3,17	154	46	3,35	178	47	3,81	189	47	4,02	217	48	4,54	249	49	5,10
	1	73	23	3,11	77	23	3,28	89	24	3,74	94	24	3,94	109	24	4,45	124	25	5,00
140.4	6	310	103	3,00	325	104	3,12	371	106	3,50	391	107	3,66	445	109	4,08	515	112	4,60
	5	270	86	3,15	283	86	3,29	320	88	3,66	339	88	3,84	383	90	4,27	437	91	4,79
	4	224	67	3,34	235	68	3,48	268	69	3,90	283	69	4,09	321	70	4,56	365	72	5,10
	3	172	52	3,32	181	52	3,48	208	53	3,92	220	53	4,12	251	54	4,62	287	55	5,19
	2	120	37	3,27	128	37	3,46	148	37	3,96	157	38	4,17	181	38	4,73	209	39	5,36
	1	60	19	3,20	64	19	3,38	74	19	3,88	79	19	4,08	91	20	4,63	105	20	5,25
160.4	4	342	112	3,05	360	114	3,16	410	116	3,54	432	118	3,67	490	120	4,08	569	124	4,60
	3	259	87	2,99	274	87	3,14	314	88	3,56	331	89	3,74	380	90	4,21	434	92	4,72
	2	181	58	3,14	192	58	3,31	222	59	3,77	235	59	3,97	270	60	4,49	310	61	5,04
	1	90	29	3,07	96	30	3,24	111	30	3,69	117	30	3,89	135	31	4,40	155	31	4,94
180.4	6	398	133	3,00	417	134	3,12	471	136	3,47	497	137	3,63	563	139	4,05	651	142	4,59
	5	341	109	3,12	358	110	3,26	405	112	3,63	429	113	3,81	484	114	4,24	553	116	4,75
	4	284	86	3,31	298	86	3,45	339	88	3,87	358	88	4,05	406	90	4,52	462	91	5,05
	3	218	66	3,29	230	67	3,45	263	68	3,89	278	68	4,08	317	69	4,58	363	71	5,15
	2	152	47	3,24	161	47	3,43	188	48	3,93	199	48	4,13	229	49	4,69	265	50	5,31
	1	76	24	3,17	81	24	3,36	94	24	3,84	99	25	4,05	115	25	4,59	132	25	5,20
200.4	6	439	144	3,05	460	145	3,17	522	148	3,53	551	149	3,70	620	152	4,08	717	155	4,63
	5	376	119	3,15	395	120	3,28	446	122	3,66	473	123	3,84	533	125	4,27	608	127	4,78
	4	313	94	3,34	328	94	3,48	373	96	3,90	394	96	4,09	447	98	4,56	509	100	5,09
	3	240	72	3,31	253	73	3,47	290	74	3,92	306	74	4,12	350	76	4,62	400	77	5,19
	2	167	51	3,27	178	51	3,46	206	52	3,96	219	53	4,17	252	53	4,73	291	54	5,35
	1	84	26	3,20	89	26	3,38	103	27	3,87	109	27	4,08	126	27	4,63	146	28	5,25
220.4	6	473	158	2,99	495	159	3,11	563	162	3,48	593	163	3,64	667	166	4,01	769	170	4,52
	5	404	131	3,09	424	131	3,23	480	134	3,59	508	135	3,78	574	137	4,20	655	139	4,70
	4	336	102	3,28	353	103	3,42	402	105	3,83	424	106	4,02	481	107	4,48	547	109	5,01
	3	258	79	3,26	272	80	3,41	312	81	3,85	330	82	4,04	376	83	4,54	430	84	5,10
	2	180	56	3,21	191	56	3,40	222	57	3,89	236	58	4,09	272	58	4,65	314	60	5,26
	1	90	29	3,14	96	29	3,32	111	29	3,81	118	29	4,01	136	30	4,55	157	30	5,16
240.4	4	510	169	3,02	534	170	3,14	602	173	3,48	636	174	3,65	716	177	4,04	823	180	4,57
	3	378	128	2,96	400	128	3,12	459	130	3,53	484	131	3,70	556	133	4,18	634	136	4,68
	2	264	85	3,11	280	85	3,28	324	87	3,74	343	87	3,94	395	89	4,45	452	91	5,00
	1	132	43	3,05	140	44	3,21	162	44	3,66	172	45	3,86	198	45	4,36	226	46	4,90

kWt = Heating capacity in kW kWe_tot = Unit total power input in kW
 STEP = Active capacity steps (the maximum number indicates full capacity / the minimum number indicates the smallest partialization step)
 Internal exchanger water = output temperature 35°C / input * (variable) / constant flow equal to the max. step nominal value.

Total recovery device operation

TOTAL OPERATING ENERGY RECOVERY

When hot water is requested, the condensing coil is deactivated. Condensation takes place wholly within the recovery circuit.

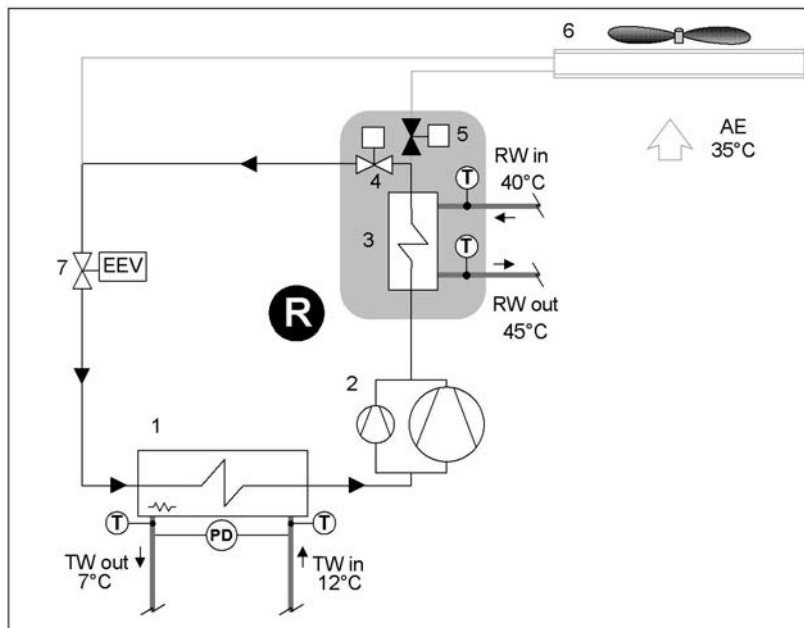

TOTAL NON-OPERATING ENERGY RECOVERY

When the recovery set-point has been satisfied, the condensing coil is reactivated. In this condition, the total recovery circuit operates as a partial recovery circuit (Desuperheater).

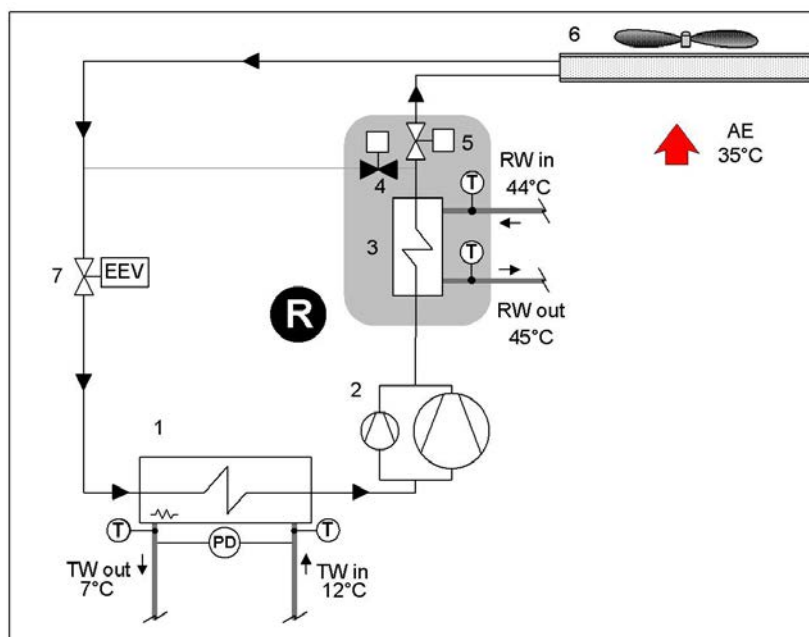

- R - Total recovery device
- 1 - Internal exchanger
- 2 - Compressors
- 3 - Recovery exchanger
- 4 - Total recovery enabling valve

- 5 - External exchanger enabling valve
- 6 - External exchanger
- 7 - Expansion electronic valve
- T - Temperature probe
- TW in chilled water inlet

- TW out chilled water outlet
- RW in - Recovery water input
- RW out - Recovery water output
- PD - Differential pressure switch
- AE Outdoor air



Post-heating in air handling units to control humidity levels in hospitals and labs



Preheating of hot water for domestic use or for industrial process



Heating of water in swimming pools, showers and SPAS



Preheating of hot water for laundries and industrial kitchens

Air heating

The heat recovery device can be used to cover the entire heat load required. The hot water supply temperature is controlled via a modulating control valve that needs to be fitted on the system at the outlet of the recovery unit. The auxiliary heating device is recommended to cover the thermal energy demand when the chiller is not in operation or is operating at part load.

Example of how heat recovery is used to cover the entire heat demand and control the operating temperature

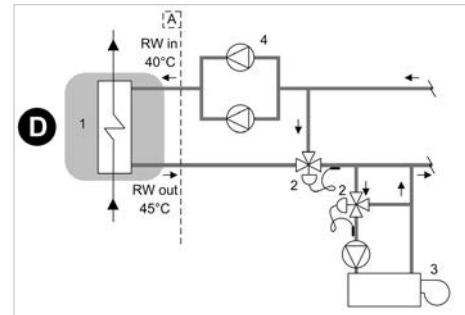

Water preheating

The heat recovery device can be used to preheat water at the inlet of the main heating device (e.g. boiler). In this case, the demand for hot water is greater than the amount of heat recovered by condensation and the recovery device only covers part of the required heat load. By preheating the water, heating consumption levels are therefore reduced and the main heating device has a lower installed power requirement.

Example of how heat recovery is used to preheat hot water in the system

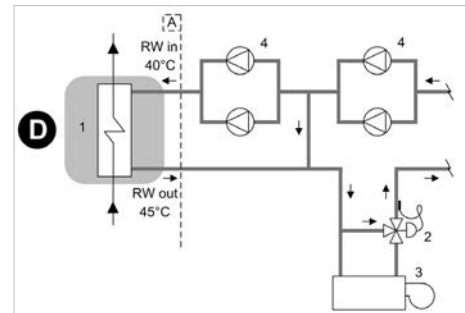

Domestic hot water production

The heat recovery device can be used to produce water for domestic use. In order to prevent contamination of domestic water with the chiller's process fluid, it is necessary to insert an intermediate heat exchanger. Using an inertial heat storage tank allows to have a reserve of preheated water and enables the intermediate exchanger to operate more efficiently.

Example of how heat recovery is used to preheat hot water for domestic use

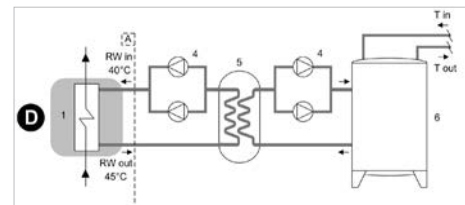

- A - Unit supply limit
- 1 - Recovery exchanger
- 3 - Auxiliary heating device (ex.boiler)
- 5 - Intermediate heat exchanger
- RW in - Recovery water input
- T in - Drinkable water inlet

- D - Partial energy recovery
- 2 - Control modulating valve
- 4 - Electric pump with standby pump
- 6 - Inertial heat storage
- RW out - Recovery water output
- T out - Drinkable water outlet to the auxiliary heater

The diagrams refer to partial energy recovery, though they also apply to total energy recovery (Clivet R). Please note that the diagrams are only meant as a guide.

HydroPack

2PM/3PM - Hydronic assembly user side with 2/3 ON/OFF pumps

Option supplied on the unit. Pumping unit consisting of parallel electric pumps with a self-adaptive modular activation logic.

It enables the automatic reduction of the liquid flow rate in critical conditions, avoiding blocks due to overloading and consequential intervention work by specialised technical personnel.

Centrifugal electric pump with impeller made with AISI 304 steel and AISI 304 stainless steel body or grey cast iron (depending on models).

Mechanical seal using ceramic, carbon and EPDM elastomer components.

Three-phase electric motor with IP44-protection. Complete with thermoformed insulated casing, quick connections with insulated casing, non return valve, safety valve, pressure gauges, system load safety pressure switch, stainless steel antifreeze immersion heaters located at the return and supply point.

The various models which are available can be differentiated by the system available pressure.

Data and features are valid only for cold user side (4T) or user side pump installation (2T).



The 2PM / 3PM option is supplied with a kit made up of 2 quick blind connections, for the removal of one pump in case of maintenance.



Check the option compatibility table for combinations with storage tank.



Provided with hydraulic interceptions to the outside of the unit (option 'CSVX - A pair of manually operated shut-off valves') to facilitate any major maintenance operations

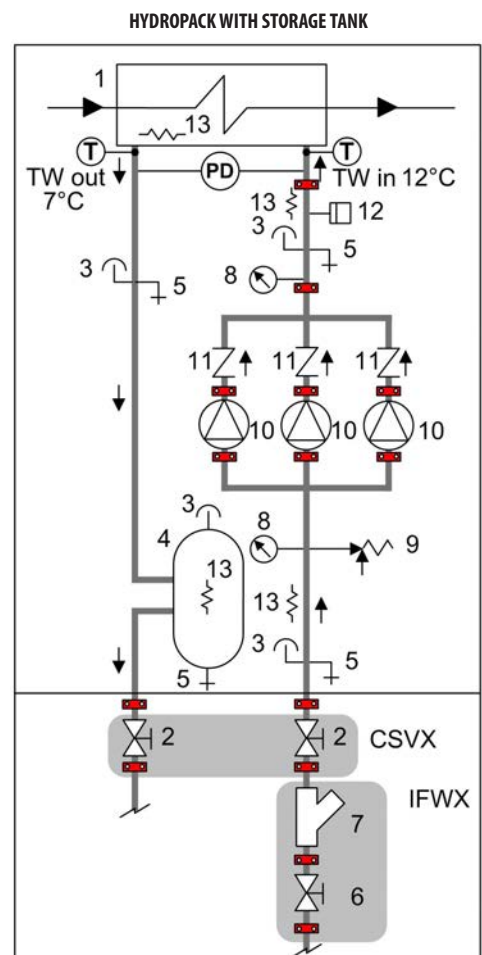
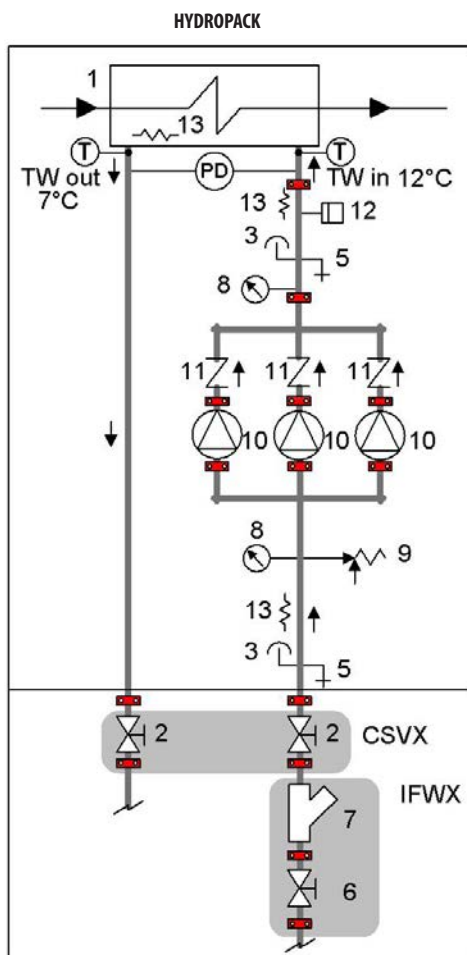

Illustrative diagram referred to unit size 240.4 with HydroPack with no. 3 of pumps

- | | |
|---|---|
| 1 - User side exchanger | 8 - Manometer |
| 2 - Cutoff valve | 9 - Safety valve (6 Bar) |
| 3 - Purge valve | 10 - Packaged electric pump with high efficiency impeller |
| 4 - Storage tank with antifreeze heater | 11 - Non return valve |
| 5 - Draw off cock | 12 - System safety pressure switch (prevents the pumps from operating if no water is present) |
| 6 - Cutoff valve with quick joints | 13 - Antifreeze heater |
| 7 - Steel mesh strainer water side | |
- T - Temperature probe

- PD - Differential pressure switch
 TW in chilled water inlet
 TW out chilled water outlet
- IFWX = Steel mesh strainer water side

CSVX - Couple of manual shut-off valves
The grey area indicates further optional components.

2PM/3PM option performances

Head

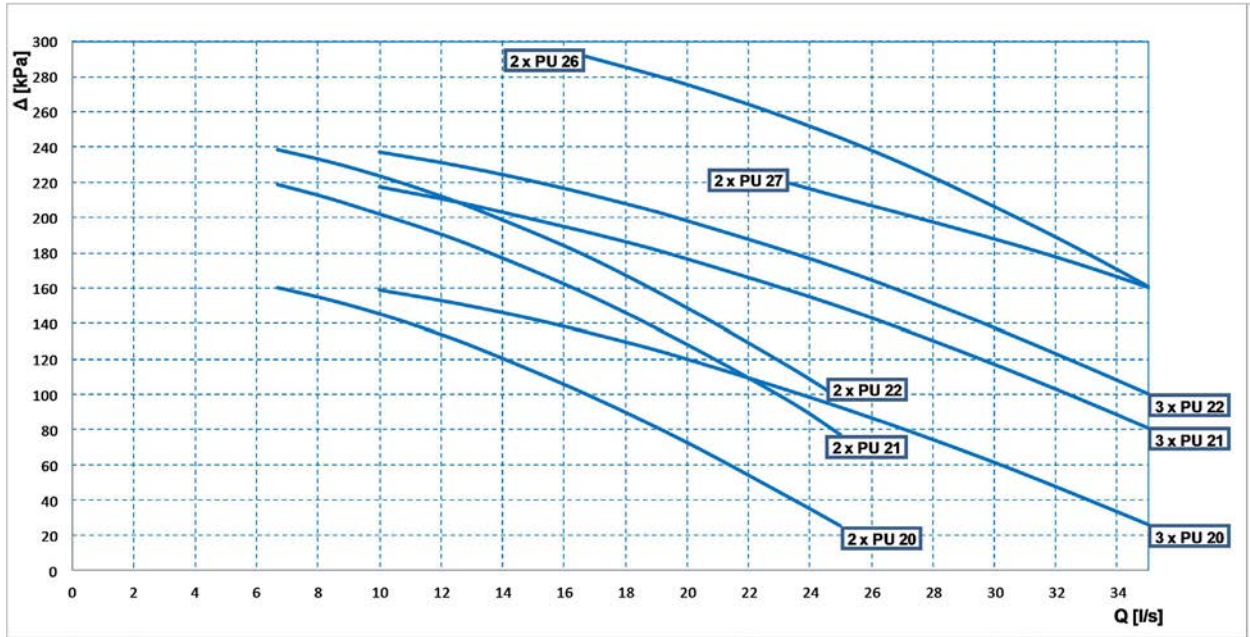

Q [l/s]= water flow rate
 Δ [kPa] = pump head
 PU2* = 2-pole pump

Check the “Option compatibility” table for the pumping unit availability in the different sizes and configurations.



Caution: to obtain the available pressure values, you need to subtract the following from the head values represented in these diagrams:

- User side exchanger pressure drops
- IFVX accessory –Steel mesh filter on the water side (where applicable)

Hydropack electrical data

PUMP	Rated power [kW]	Nominal power [A]
2xPU20	2x1.8	2x3.4
2xPU21	2x2.9	2x4.8
2xPU22	2x3.3	2x5.6
2xPU26	2x5.5	2x10.4

PUMP	Rated power [kW]	Nominal power [A]
2xPU27	2x5.5	2x10.4
3xPU20	3x1.8	3x3.4
3xPU21	3x2.9	3x4.8
3xPU22	3x3.3	3x5.6

2PMV/3PMV - Hydronic assembly user side with 2/3 inverter pumps

HYGR2V/HYGR3V - Hydronic assembly recovery side with 2/3 inverter pumps

Option supplied on the unit. Pumping unit consisting of parallel electric pumps and controlled by inverter to adapt to the different application conditions.

It enables the automatic reduction of the liquid flow rate in critical conditions, avoiding blocks due to overloading and consequential intervention work by specialised technical personnel.

Through the inverter calibration, standard supplied, it is possible to adapt the pump flow-rate/head to the installation feature.

Centrifugal electric pump with impeller made with AISI 304 steel and AISI 304 stainless steel body or grey cast iron (depending on models).

Mechanical seal using ceramic, carbon and EPDM elastomer components.

Three-phase electric motor with IP44-protection. Complete with thermoformed insulated casing, quick connections with insulated casing, non return valve, safety valve, pressure gauges, system load safety pressure switch, stainless steel antifreeze immersion heaters located at the return and supply point.

In combination with the "IVFDT" - Variable flow-rate control option, it allows the water flow rate variation to the installation in part load operation to obtain the maximum unit efficiency and lower pumping unit consumption.

- The 2PMV / 3PMV and HYGR2V / HYGR3V options are supplied with a kit made up of 2 quick blind connections, for the removal of one pump in case of maintenance.
- Check the option compatibility table for combinations with storage tank.
- Provided with hydraulic interceptions to the outside of the unit (option 'CSVX - A pair of manually operated shut-off valves') to facilitate any major maintenance operations

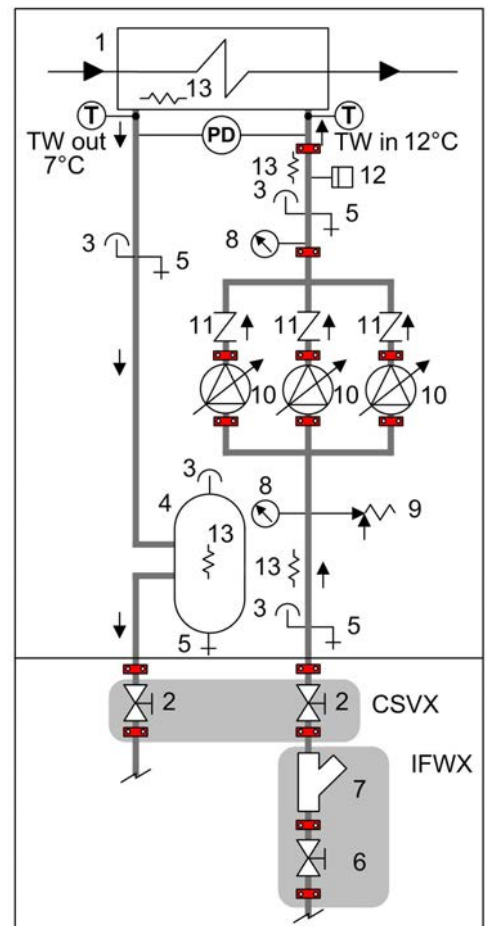
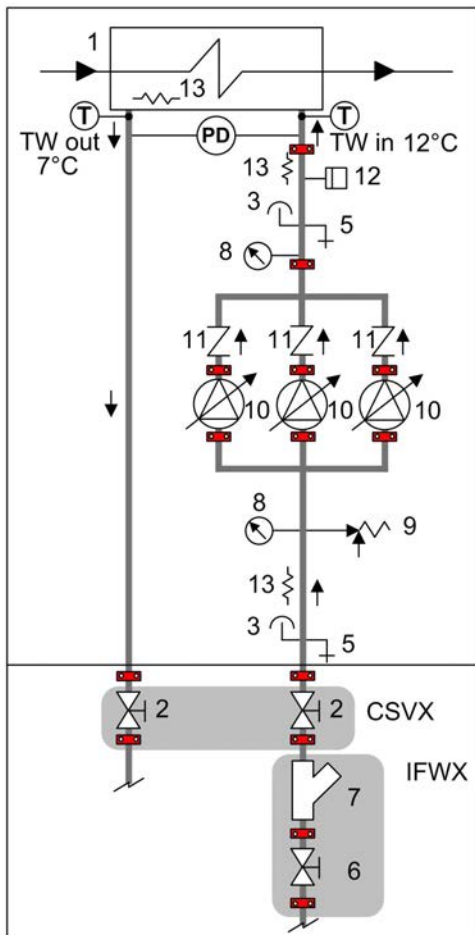

- 1 - Internal exchanger
- 2 - Cutoff valve
- 3 - Purge valve
- 4 - Storage tank
- 5 - Draw off cock
- 6 - Cutoff valve with quick joints
- 7 - Steel mesh strainer water side

- 8 - Manometer
- 9 - Safety valve (6 Bar)
- 10 - Packaged electric pump with high efficiency impeller activated by inverter
- 11 - Non return valve
- 12 - System safety pressure switch (prevents the pumps from operating if no water is present)
- 13 - Antifreeze heater
- T - Temperature probe

- PD - Differential pressure switch
- TW in chilled water inlet
- TW out chilled water outlet
- IFWX = Steel mesh strainer water side
- CSVX - Couple of manual shut-off valves

The grey area indicates further optional components.

2PMV / HYGR2V option performances

Head

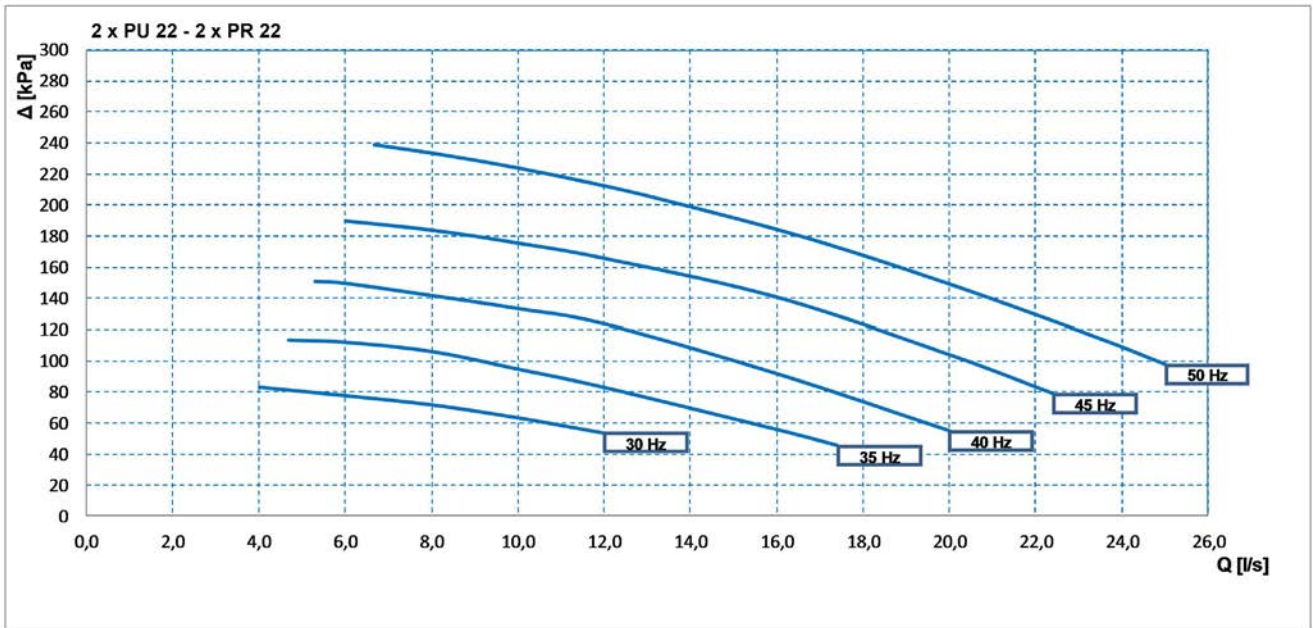

Q[l/s]= water flow rate
 Δ [kPa] = pump head



Caution: to obtain the available pressure values, you need to subtract the following from the head values represented in these diagrams:

- internal exchanger pressure drops
- IFVX accessory –Steel mesh filter on the water side (where applicable)

Power input

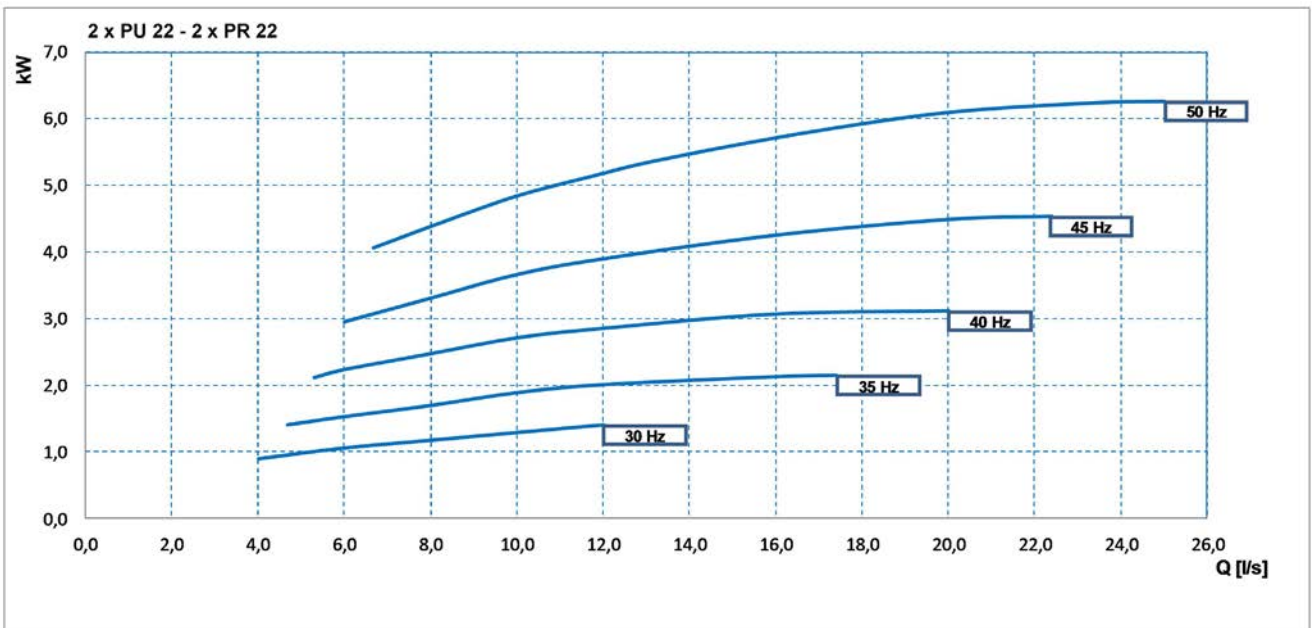

Q[l/s]= water flow rate
 kW = power input

3PMV / HYGR3V option performances

Head

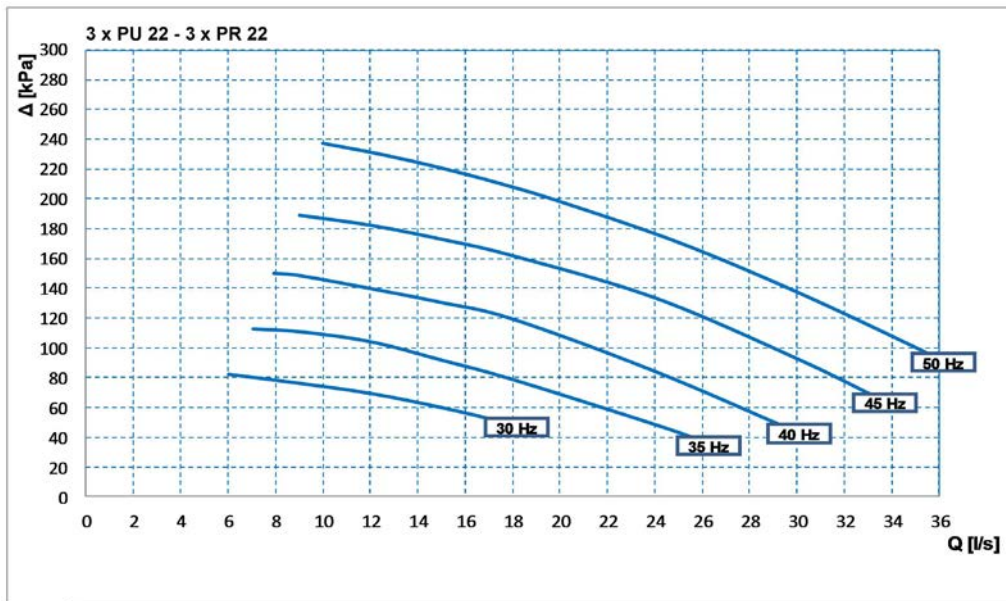

Q[l/s]= water flow rate
 Δ [kPa] = pump head

Caution: to obtain the available pressure values, you need to subtract the following from the head values represented in these diagrams:



- internal exchanger pressure drop
- IFVX accessory –Steel mesh filter on the water side (where applicable)

Power input

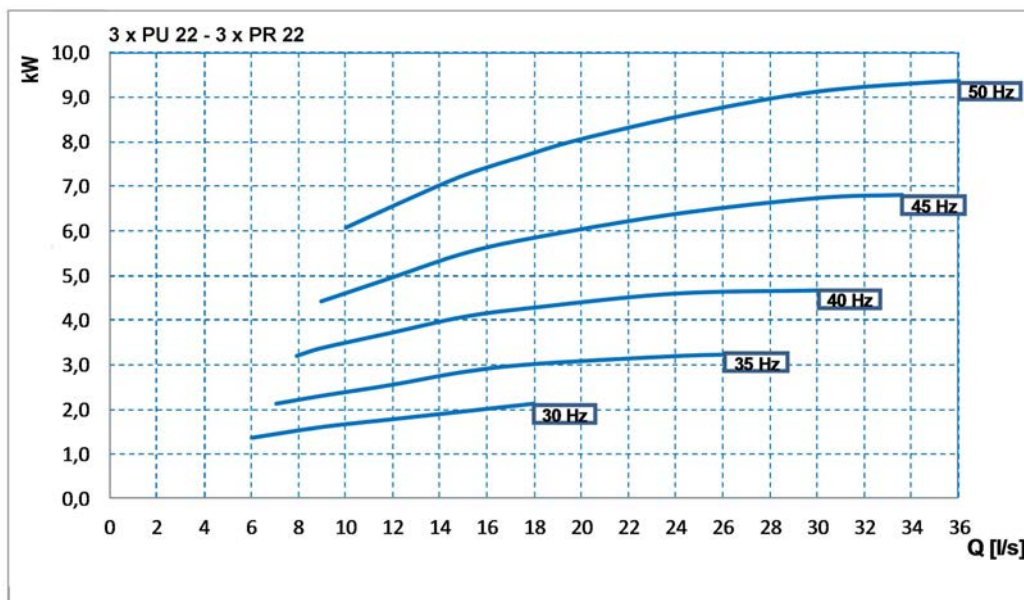

Q[l/s]= water flow rate
 kW = power input

Built-in pump electrical data

PUMP	Rated power [kW]	Nominal power [A]
2×PU22	2×3.3	2×5.6
2×PR22	2×3.3	2×5.6
3×PU22	3×3.3	3×5.6
3×PR22	3×3.3	3×5.6

Accessories - Hydronic assembly

A550/A700/A900 - 550 / 700 / 900 l. storage tank

Carbon steel storage tank built-in supplied, complete with external double layer covering with closed-cell insulation 30mm thick, stainless steel anti-freeze immersion, bleed valve, discharge stop valve, Victaulic type quick connections with insulated casing. Massima pressione di esercizio 10 bar. Maximum operating pressure of 10 bar. Suitable for operation with mixtures of glycol-water.

 The storage tank connection can be user side "CAU" (2T or 4T) or recovery side "CAR" (only 4T)

 Provided with hydraulic interceptions to the outside of the unit (option 'CSVX - A pair of manually operated shut-off valves') to facilitate any major maintenance operations

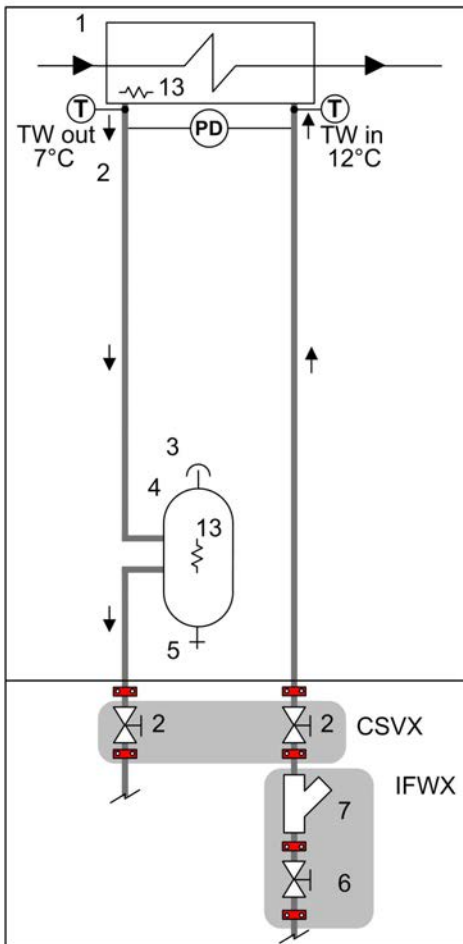

- 1 - Internal exchanger
- 2 - Cutoff valve
- 3 - Purge valve
- 4 - Storage tank with antifreeze heater
- 5 - Draw off cock
- 6 - Cutoff valve with quick joints
- 7 - Steel mesh strainer water side
- 13 - Antifreeze heater

T - Temperature probe
PD - Differential pressure switch

TW in chilled water inlet
TW out chilled water outlet

IFWX = Steel mesh strainer water side
CSVX - Couple of manual shut-off valves

The grey area indicates further optional components.

 Check the option compatibility table for the storage tank availability in the different sizes.

IFWX - Steel mesh strainer water side

The device stops the exchanger from being clogged by any impurities which are in the hydraulic circuit. The mechanical steel mesh strainer must be placed on the water input line. It can be easily dismantled for periodical maintenance and cleaning. It also includes: cast-iron shut-off butterfly valve with quick connections and activation lever with a mechanical calibration lock; quick connections with insulated casing.

STEEL KNIT FILTER PRESSURE DROP

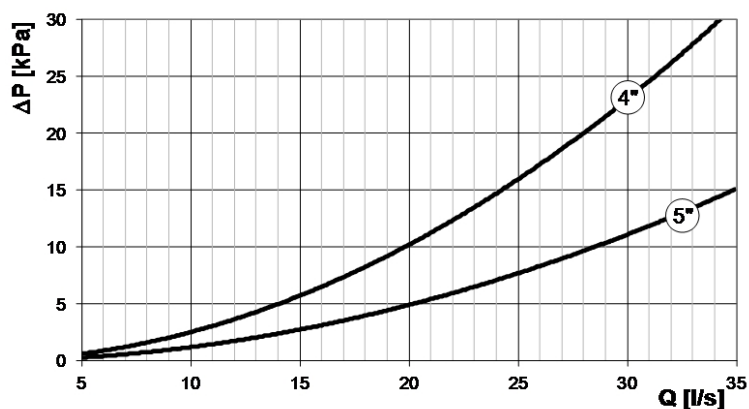

STEEL MESH FILTER FEATURES

EXCELLENCE	90.4-140.4	160.4-240.4
Diameter	4"	5"
Degree of filtration	1,6 mm	



Q = water flow rate (l/s) DP = water side pressure drop (kPa)



Pressure drop referred to a clean filter



Installation is the responsibility of the Client, externally to the unit



Check for the presence of the required hydraulic shut-off valves in the system, in order to undertake periodical maintenance

Separately supplied accessory and available both for user side and recovery side exchanger.

CSVX - Couple of manual shut-off valves

It kit allows to isolate the hydraulic circuit at the inlet and outlet.

It includes:

- no. 2 cast-iron shut-off butterfly valves with fast fittings and activation lever with a mechanical calibration lock
- no. 2 of quick connections



Installation is the responsibility of the Client, externally to the unit.



Separately supplied accessory and available both for user side and recovery side exchanger.

Accessories

PGFC- Finned coil protection grilles

This accessory is used to protect the external coil from the accidental contact with external things or people.

The protection grill has a height equal to the whole unit. Therefore, all areas under the coils are protected.

This accessory also protects the rear area of the unit opposite to the electric panel.

Ideal for installation in places where persons can pass from, such as car parks, terraces, etc.

The accessory is provided and installed built-in the unit.



PGCCH - Condensing coil anti-hail protection grilles

These accessories are to protect the external coil from hail damage. Indeed, hail impact can deform the coil fins worsening the heat exchange with the air.

The accessory is provided and installed built-in the unit.



CCCA - Copper / aluminium condensing coil with acrylic lining

Coils with copper pipes and aluminium fins with acrylic lacquering. Can be used in settings with moderately aggressive low saline concentrations and other chemical agents.

Attention!

- Cooling capacity variation -2.7%
- Variation in compressor power input +4.2%
- Operating range reduction -2.1°C

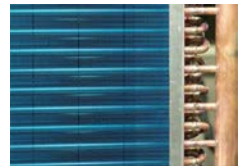

CCCA1 - Copper / aluminium condensing coils with Aluminium Energy Guard DCC treatment

A treatment which offers an optimal thermal exchange and guarantees and protects the finned coil exchangers from corrosion over time. Can be used in settings with very aggressive saline concentrations and other chemical agents in the air thus maintaining the performance of the coils over time.



CCCC - Copper / copper condensing coil

Coils with copper pipes, copper fins and brass structure. Can be used in settings with moderately aggressive saline concentrations and other chemical agents.



This option is not suitable for application in sulphuric environments



Option available only on special request

MHP - High and low pressure gauges

Although the standard unit already displays digital parameters of pressures in the refrigeration circuit, this option allows analog display of refrigerant pressures on suction and discharge lines for ease of use by maintenance technicians.

The two liquid pressure gauges and corresponding pressure sockets are installed on the machine in an easily accessible location.

The device is installed built-in the unit.



SDV - Cutoff valve on compressor supply and return

An option which integrates the supply cutoff valve, which is supplied as standard. The presence of the cock at the intake as well enables the compressors to be isolated and substituted without discharging the refrigerant from within the refrigeration circuit. This means that the extraordinary maintenance activities are facilitated.

The device is installed built-in the unit.

1. Compressors
2. Cutoff valve
3. Safety valve
4. SDV option

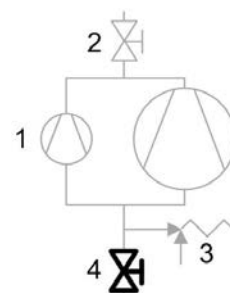

RE-20 / RE-25 / RE-30 / RE-35 / RE-39 - Electrical panel anti-freeze protection

This option is necessary for very cold climates, where the external temperature can be between -10°C and -39°C . It includes self-regulating temperature maintaining resistances which are able to protect the electrical panel against condensation and frost guaranteeing that it functions correctly. The choice of device should be carried out on the basis of the minimum temperatures reached at the unit installation site.

The device is installed built-in the unit.



This accessory operates even when the unit is switched off provided that the power supply is maintained active and the unit continues to be connected.



This accessory does not lead to substantial variations in the electrical data for the unit which has been declared in the Electrical Data section.



Not compatible with 2PM/3PM and HYGR2V/HYGR3V in the size 240.4.



PFCP - Power-factor capacitors (cosfi > 0.9)

The component is necessary to lower the phase difference between current and voltage in the electromagnetic components of the unit (e.g. asynchronous motors). The component allows to put the cosfi power factor to values on average higher than 0.9, reducing the network reactive power. This often leads to an economic benefit which the energy provider grants to the final user.

The device is installed and wired built-in the unit.



ECS - ECOSHARE function for the automatic management of a group of units

The device allows automatic management of units that operate on the same hydraulic circuit, by creating a local communication network. There are two control modes that can be set via a parameter during the activation stage. They both distribute the heat load on the available units by following the distribution logic to benefit from efficiency levels at part load.

Moreover:

Mode 1 - it keeps all the pumps active

Mode 2 - it activates only the pumps of the unit required to operate

The device allows for rotation based on the criterion of minimum wear and management of units in stand-by. Units must be of the same type: all reversible heat pumps, or all cool only, or all heat only. Sizes can be different. There are various unit sizes. Every unit must be fitted with the ECOSHARE feature. The set of units is controlled by a Master unit.

The local network can be extended up to 7 units (1 Master and 6 Slave).



The unit supplied with this device can also be equipped at the same time with the RCMRX option and one of the CMSC11 / CMSC9 / CMSC10 options.

IVFDT - Inverter driven variable flow-rate user side control depending on the temperature differential

This option allows water flow-rate modulation to the unit during partial load conditions, maintaining stable the temperature difference between inlet and outlet to the heat exchanger.

The option is available only when the unit thermoregulation is set on the return temperature.

With no building load the unit switches off the compressors while concerning pumps is possible to select:

- Active pumps with minimum flow-rate, monitoring secondary circuit temperature variations
- Pump switching off, periodically activating them (settable time) leading secondary circuit temperatures on primary circuit
- Pump switching off and waiting for the user signal for activation (free potential)

Flow-rate modulation is managed by embedded logic thanks to built-in flow-rate control device and temperature probes. This device is installed and wired.



This option is available only with inverter driven HYDROPACK selected (2PMV / 3PMV)



The water flow control is active only with thermoregulation on the return temperature.

SFSTR – Starting current reduction device (SOFT STARTER)

Electronic device which automatically starts up the compressors gradually, reducing the starting current for the unit by around 40% in comparison with the nominal value. This results in the reduction of the starting torque of the ON/OFF compressor, it is more protected from mechanical stresses leading to an increased life of the component. The noise is also reduced.

Device installed and wired built-in the unit.



In sizes 180.4, 200.4, 220.4 and 240.4 the larger size compressor is standard equipped with device for progressive start-up, defined part-winding. For these units the soft-starter benefits are guaranteed on lower size compressors, maintaining unchanged the M.I.C. (max. inrush current) of the standard unit.



The compressors with 60 HP of nominal capacity need the standard device for the progressive start-up defined part-winding.

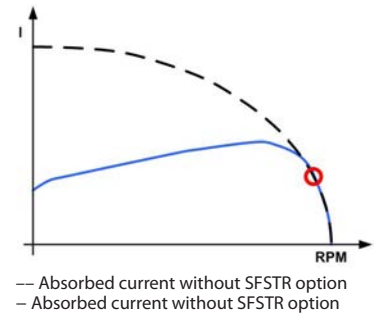

CMSC11 - Serial communication module for BACnet-IP supervisor

This enables the serial connection of the supervision system, using BACnet/IP as the communication protocol. It enables access to the complete list of operational variables, commands and alarms. Using this accessory every unit can dialogue with the main supervision systems.

The device is installed and wired built-in the unit.



The configuration and management activities for the BACnet networks are the responsibility of the client.



The total length of each serial line do not exceed 1000 meters and the line must be connected in bus typology (in/out)

CMSC9 - Serial communication module for Modbus supervisor

This enables the serial connection of the supervision system, using Modbus as the communication protocol. It enables access to the complete list of operational variables, commands and alarms. Using this accessory every unit can dialogue with the main supervision systems.

The device is installed and wired built-in the unit.



The total length of each serial line do not exceed 1000 meters and the line must be connected in bus typology (in/out)

CMSC10 - Serial communication module for LonWorks supervisor

This enables the serial connection of the supervision system which uses the LonWorks communication protocol. It enables access to a list of operating variables, commands and alarms which comply with the Echelon® standard.

The device is installed and wired built-in the unit.



The configuration and management activities for the LonWorks networks are the responsibility of the client.



LonWorks technology uses the LonTalk® protocol for communicating between the network nodes. Contact the service supplier for further information.



The total length of each serial line do not exceed 1000 meters and the line must be connected in bus typology (in/out)

CREFB - Device for fan consumption reduction of the external section, ECOBREEZE type

An option which regards the external helical fans, as an alternative to the phase-cut device. It provides for an IP54 brushless electronically commutated electrical motor and incorporated thermal protection. Supplied with variable speed control.

CONTA2 - Energy meter

Allows to display and record the unit's main electrical parameters. The data can be displayed on the device display or via the supervisor through the specific protocol variables..

It is possible to control:

- voltage (V),
- absorbed current (A),
- frequency (Hz),
- $\cos\phi$,
- power input (KW),
- absorbed energy (KWh),
- harmonic components (%).

The device is installed and wired built-in the unit.

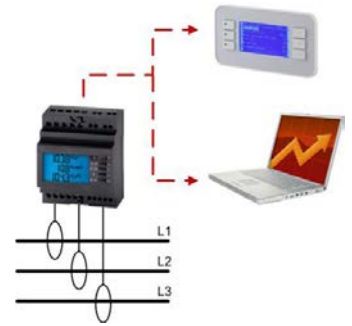

On the device is present a serial port with Modbus protocol for the connection to the supervision system.

SCP4 - Set-point compensation with 0-10 V signal

This device enables the set-point to be varied which is pre-set using an external 0÷10 V signal.

The device is installed and wired built-in the unit.



SPC2 - Set-point compensation with outdoor temperature probe

This device enables the set-point to be varied automatically which is pre-set depending on the enthalpy of the outdoor air. This device enables the liquid flow temperature to be obtained, which varies depending on external conditions, enabling energy savings throughout the entire system.

The device is installed and wired built-in the unit.

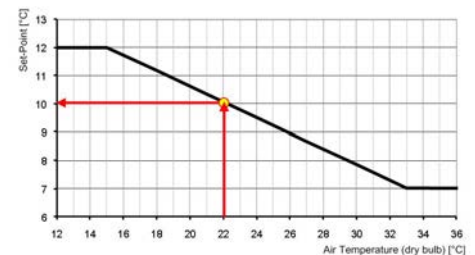

OHE - Limit extension kit in heating up to -10°C (W.B.)

The device allows to extend heating unit operation fields up to -10°C wet bulb outdoor temperature. Clivet automatic control ensures the ongoing operation at the unit full capacity.

The device is installed and wired built-in the unit.

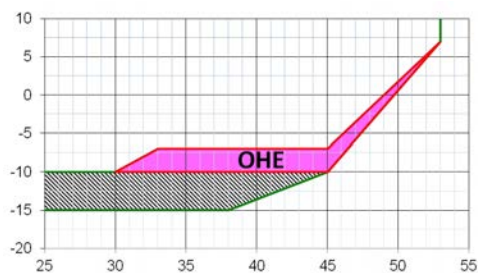

2-pipe configuration - Extended operating range with OHE kit

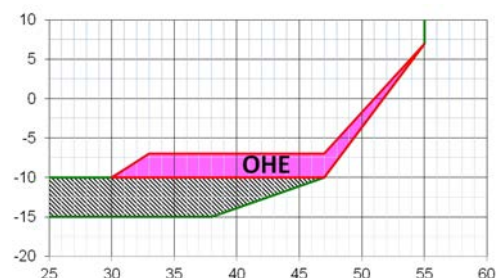

4-pipe configuration - Extended operating range with OHE kit

RPRI - Refrigerant leak detector assembled on the casing

Leak detector device built-in installed and placed inside the compressor box, it detects leaks of the internal refrigeration circuit.

Accessories separately supplied

RCMRX - Remote control via microprocessor remote control

This option allows to have full control over all the unit functions from a remote position.

It can be easily installed on the wall and has the same aspect and functions of the user interface on the unit.

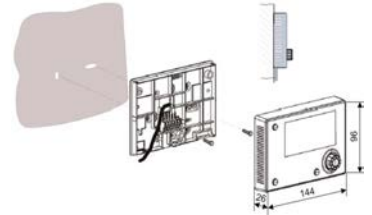

All device functions can be repeated with a normal portable PC connected to the unit with an Ethernet cable and equipped with an internet navigation browser.



The device must be installed on the wall with suitable plugs and connected to the unit (installation and wiring to be conducted by the Customer). Maximum remote control distance 350 m without auxiliary power supply. For distances greater than 350 m and in any case less than 700 m it is necessary to install the 'PSX - Mains power unit' accessory.



Data and power supply serial connection cable n.1 twisted and shielded pair. Diameter of the individual conductor 0.8 mm.



Installation provided by Customer

PSX - Mains power supply unit

The device allows the unit and the remote control to communicate with the user interface even when the serial line is longer than 350m.

It must be connected to the serial line at a distance of 350m from the unit and allows to extend the length to 700m maximum in total. The device requires an external power supply at 230V AC.



Power supply at 230V AC provided by Customer

AMMX - Spring antivibration mounts

The spring antivibration mounts are attached in special housing on the support frame and serve to smooth the vibrations produced by the unit thus reducing the noise transmitted to the support structure.



Installation provided by Customer



Option compatibility - Configuration for 2-pipe and 4-pipe system

Acoustic configuration: compressor soundproofing (SC)

REFERENCE	DESCRIPTION	90.4	100.4	110.4	120.4	140.4	160.4	180.4	200.4	220.4	240.4
Storage tank											
A550	550 l. storage tank	0	0	0	0	-	-	-	-	-	-
A700	700 l. storage tank	-	-	-	-	0	0	-	-	-	-
A900	900 l. storage tank	-	-	-	-	-	-	0	0	0	0
+ CAU + 4T	+ Storage tank connection user side + Configuration for 4-pipe system	0	0	0	0	0	0	0	0	0	0
+ CAR + 4T	+ Storage tank connection recovery side + Configuration for 4-pipe system	0	0	0	0	0	0	0	0	0	0
+ CAU + 2T	+ Storage tank connection user side + Configuration for 2-pipe system	0	0	0	0	0	0	0	0	0	0
+ CAR + 2T	+ Storage tank connection recovery side + Configuration for 2-pipe system	-	-	-	-	-	-	-	-	-	-
2PM - Hydropack user side with no. 2 of pumps											
(PU20)	Pump 20	0	0	0	0	0	-	-	-	-	-
(PU21) / (PU22)	Pump 21 / Pump 22	0	0	0	0	0	0	0	-	-	-
(PU26)	Pump 26	-	-	-	-	-	-	-	0	0	0
+ A550	+ 550 l. storage tank	0	0	0	0	-	-	-	-	-	-
+ A700	+ 700 l. storage tank	-	-	-	-	0	0	-	-	-	-
+ A900	+ 900 l. storage tank	-	-	-	-	-	-	0	0	0	0
+ RE-20/RE-25/RE-30/ RE-35/RE-39	+ Electrical panel antifreeze protection	0	0	0	0	0	0	0	0	0	-
3PM - Hydropack user side with no. 3 of pumps											
(PU20)	Pump 20	-	-	-	-	-	-	-	0	0	-
(PU21)	Pump 21	-	-	-	-	0	0	0	0	0	0
(PU22)	Pump 22	0	0	0	0	0	0	0	0	0	0
+ A550	+ 550 l. storage tank	0	0	0	0	-	-	-	-	-	-
+ A700	+ 700 l. storage tank	-	-	-	-	0	0	-	-	-	-
+ A900	+ 900 l. storage tank	-	-	-	-	-	-	0	0	0	0
+ RE-20/RE-25/RE-30/ RE-35/RE-39	+ Electrical panel antifreeze protection	0	0	0	0	0	0	0	0	0	-
2PMV - Hydropack user side with no.2 of inverter pumps											
(PU22)	Pump 22	0	0	0	0	-	-	-	-	-	-
3PMV - Hydropack user side with no.3 of inverter pumps											
(PU22)	Pump 22	0	0	0	0	0	0	0	0	0	0
HYGR2V - Hydronic assembly recovery side with no.2 of inverter pumps											
(PR22)	Pump 22 recovery side	0	0	0	0	-	-	-	-	-	-
+ RE-20/RE-25/RE-30/ RE-35/RE-39	+ Electrical panel antifreeze protection	0	0	0	0	0	0	0	0	0	-
HYGR3V - Hydronic assembly recovery side with no.3 of inverter pumps											
(PR22)	Pump 22 recovery side	0	0	0	0	0	0	0	0	0	0
+ RE-20/RE-25/RE-30/ RE-35/RE-39	+ Electrical panel antifreeze protection	0	0	0	0	0	0	0	0	0	X
IVFDT - Inverter driven variable flow-rate user side control depending on the temperature differential											
(2PM) / (3PM)	Hydropack user side with no. 2 of pumps / Hydropack user side with no. 3 of pumps	-	-	-	-	-	-	-	-	-	-
(2PMV) / (3PMV)	Hydropack user side with no.2 of inverter pumps / Hydropack user side with no.3 of inverter pumps	0*	0*	0*	0*	0*	0*	0*	0*	0*	0*
Other accessories											
CREFB	Device for fan consumption reduction of the external section, ECOBREEZE type	0	0	0	0	0	0	0	0	0	0
CREFP	Device for consumption reduction of the external section at variable speed (phase-cutting)	•	•	•	•	•	•	•	•	•	•

• Standard

0 Option

0* Necessary matching: variable flow-rate control and built-in inverter pumps

- Not available

Option compatibility - Configuration for 2-pipe and 4-pipe system

Acoustic configuration: super-silenced (EN)

REFERENCE	DESCRIPTION	90.4	100.4	110.4	120.4	140.4	160.4	180.4	200.4	220.4	240.4
Storage tank											
A550	550 l. storage tank	0	0	0	0	-	-	-	-	-	-
A700	700 l. storage tank	-	-	-	-	0	0	-	-	-	-
A900	900 l. storage tank	-	-	-	-	-	-	0	0	0	0
+ CAU + 4T	+ Storage tank connection user side + Configuration for 4-pipe system	0	0	0	0	0	0	0	0	0	0
+ CAR + 4T	+ Storage tank connection recovery side + Configuration for 4-pipe system	0	0	0	0	0	0	0	0	0	0
+ CAU + 2T	+ Storage tank connection user side + Configuration for 2-pipe system	0	0	0	0	0	0	0	0	0	0
+ CAR + 2T	+ Storage tank connection recovery side + Configuration for 2-pipe system	-	-	-	-	-	-	-	-	-	-
2PM - Hydropack user side with no. 2 of pumps											
(PU20)	Pump 20	0	0	0	0	0	0	0	0	-	-
(PU21) / (PU22)	Pump 21 / Pump 22	0	0	0	0	0	0	0	0	-	-
(PU27)	Pump 26	-	-	-	-	-	-	-	-	0	0
+ A550	+ 550 l. storage tank	0	0	0	0	-	-	-	-	-	-
+ A700	+ 700 l. storage tank	-	-	-	-	0	0	-	-	-	-
+ A900	+ 900 l. storage tank	-	-	-	-	-	-	0	0	0	0
+ RE-20/RE-25/RE-30/RE-35/RE-39	+ Electrical panel antifreeze protection	0	0	0	0	0	0	0	0	0	-
3PM - Hydropack user side with no. 3 of pumps											
(PU20)	Pump 20	-	-	-	-	-	-	-	-	0	0
(PU21)	Pump 21	-	-	-	-	0	0	0	0	0	0
(PU22)	Pump 22	0	0	0	0	0	0	0	0	0	0
+ A550	+ 550 l. storage tank	0	0	0	0	-	-	-	-	-	-
+ A700	+ 700 l. storage tank	-	-	-	-	0	0	-	-	-	-
+ A900	+ 900 l. storage tank	-	-	-	-	-	-	0	0	0	0
+ RE-20/RE-25/RE-30/RE-35/RE-39	+ Electrical panel antifreeze protection	0	0	0	0	0	0	0	0	0	-
2PMV - Hydropack user side with no.2 of inverter pumps											
(PU22)	Pump 22	0	0	0	0	-	-	-	-	-	-
3PMV - Hydropack user side with no.3 of inverter pumps											
(PU22)	Pump 22	0	0	0	0	0	0	0	0	0	0
HYGR2V - Hydronic assembly recovery side with no.2 of inverter pumps											
(PR22)	Pump 22 recovery side	0	0	0	0	-	-	-	-	-	-
+ RE-20/RE-25/RE-30/RE-35/RE-39	+ Electrical panel antifreeze protection	0	0	0	0	0	0	0	0	0	-
HYGR3V - Hydronic assembly recovery side with no.3 of inverter pumps											
(PR22)	Pump 22 recovery side	0	0	0	0	0	0	0	0	0	0
+ RE-20/RE-25/RE-30/RE-35/RE-39	+ Electrical panel antifreeze protection	0	0	0	0	0	0	0	0	0	X
IVFDT - Variable flow-rate user side control by inverter depending on the temperature differential											
(2PM) / (3PM)	Hydropack user side with no. 2 of pumps / Hydropack user side with no. 3 of pumps	-	-	-	-	-	-	-	-	-	-
(2PMV) / (3PMV)	Hydropack user side with no.2 of inverter pumps / Hydropack user side with no.3 of inverter pumps	0*	0*	0*	0*	0*	0*	0*	0*	0*	0*
Other accessories											
CREFB	Device for fan consumption reduction of the external section, ECOBREEZE type	0	0	0	0	0	0	0	0	0	0
CREFP	Device for consumption reduction of the external section at variable speed (phase-cutting)	•	•	•	•	•	•	•	•	•	•

• Standard

0 Option

0* Necessary matching: variable flow-rate control and built-in inverter pumps

- Not available

Dimensional drawings

Size 90.4-120.4 - Acoustic configuration : Compressor soundproofing (SC) / Super-silenced (EN)

DAB2M90 4_120 4_EXC_SC_EN_0

Data/Date 17/11/2015

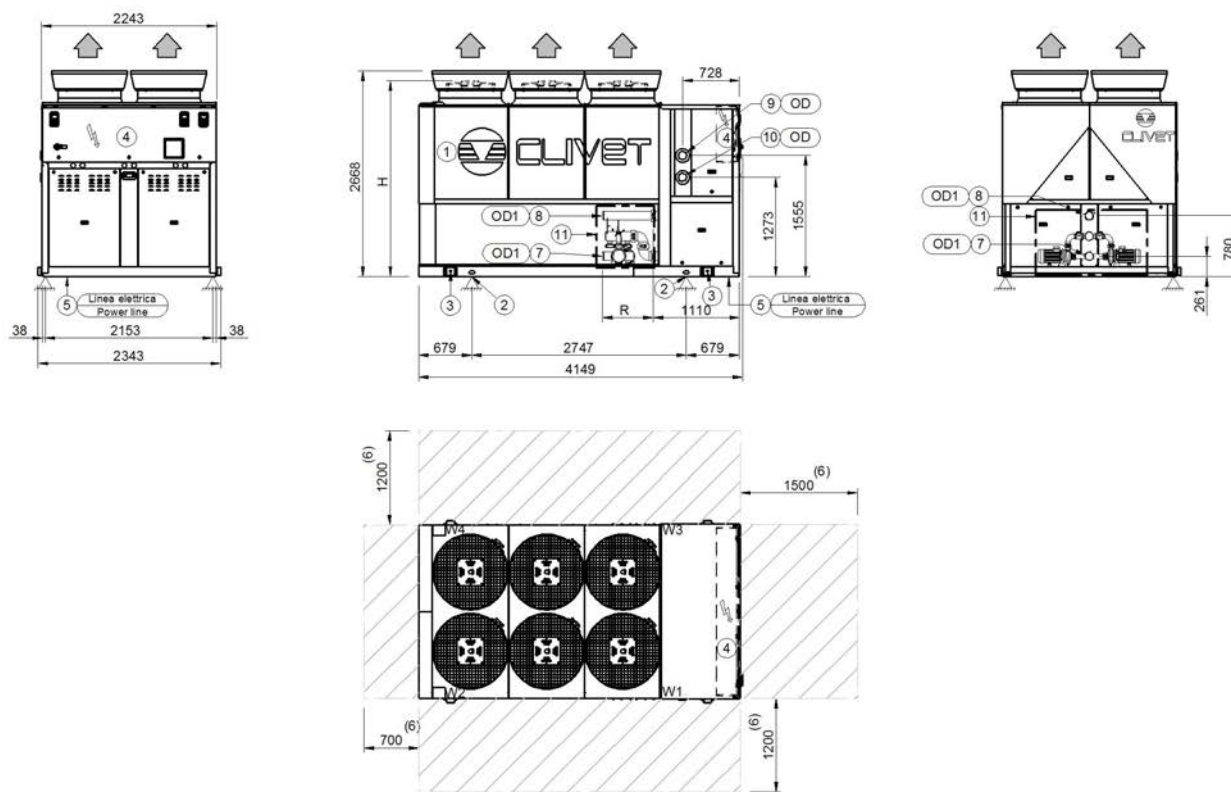

1. External exchanger
2. Antivibration fixing holes \varnothing 25mm
3. Lifting brackets (removable, if required, after unit positioning)
4. Main electrical panel
5. Power input supply
6. Recommended functional clearances
7. Entering exchanger water recovery side
8. Leaving exchanger water recovery side
9. Water inlet user side of no pumps unit / Water outlet user side of unit with pumps (optional)
10. Water outlet user side of no pumps unit / Water inlet user side of unit with pumps (optional)
11. Hydronic assembly recovery side (optional)

Size		SC-EXC				EN-EXC			
		90.4	100.4	110.4	120.4	90.4	100.4	110.4	120.4
H (without Axitop)	mm	2484	2484	2484	2484	2484	2484	2484	2484
H (without Axitop with ECOBREEZE - optional)	mm	2510	2510	2510	2510	2510	2510	2510	2510
OD (internal exchanger)	mm	114,3	114,3	114,3	114,3	114,3	114,3	114,3	114,3
OD1 (partial recovery)	mm	114,3	114,3	114,3	114,3	114,3	114,3	114,3	114,3
A - Length	mm	4149	4149	4149	4149	4149	4149	4149	4149
B - Depth	mm	2243	2243	2243	2243	2243	2243	2243	2243
C - Height	mm	2668	2668	2668	2668	2668	2668	2668	2668
R with recovery side pumps (optional)	mm	565	565	565	565	565	565	565	565
W1 Supporting point	kg	970	991	1014	1048	970	991	1014	1048
W2 Supporting point	kg	598	610	623	639	598	610	623	639
W3 Supporting point	kg	961	983	1007	1042	961	983	1007	1042
W4 Supporting point	kg	590	601	615	633	590	601	615	633
Shipping weight	kg	2971	3037	3109	3207	2971	3037	3109	3207
Operating weight	kg	3119	3185	3259	3362	3119	3185	3259	3362

Size		SC-EXC				EN-EXC			
		90.4	100.4	110.4	120.4	90.4	100.4	110.4	120.4
Container shipping length	mm	4300	4300	4300	4300	4300	4300	4300	4300
Container shipping depth	mm	2315	2315	2315	2315	2315	2315	2315	2315

The presence of optional accessories may result in a substantial variation of the weights shown in the table. Fan diffusers are separately supplied.

Size 140.4-160.4 - Acoustic configuration : Compressor soundproofing (SC) / Super-silenced (EN)

DAB2M140 4_160 4_EXC_SC_EN_0

Data/Date 16/02/2016

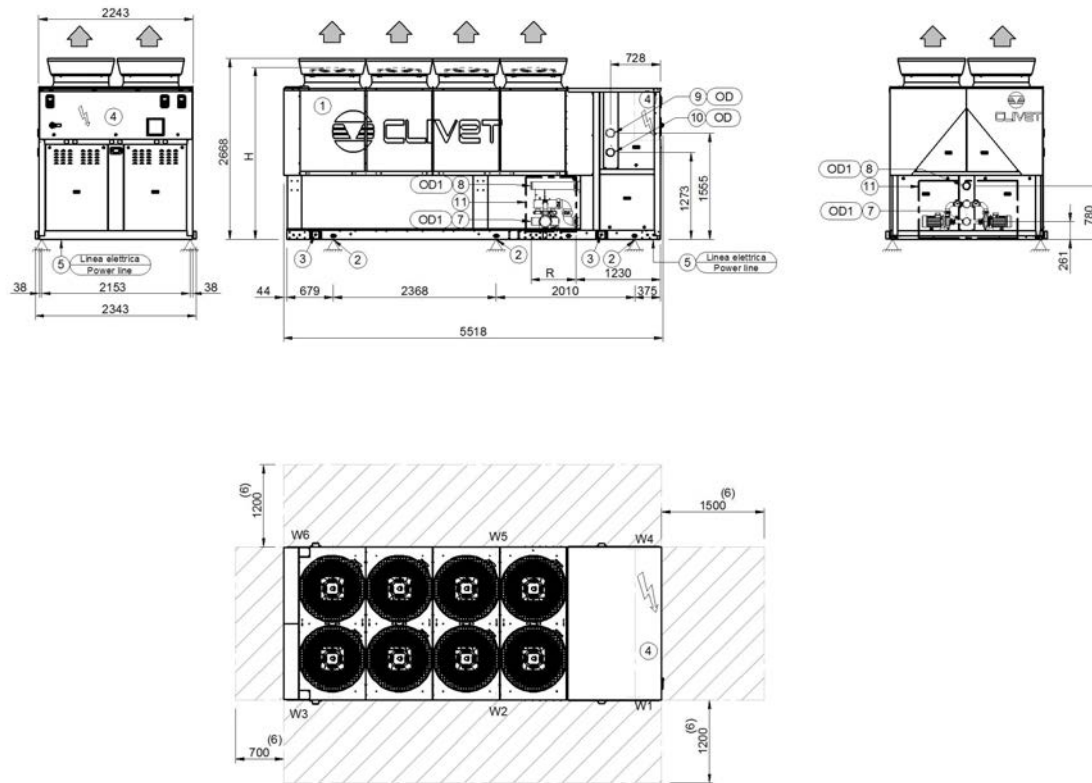

1. External exchanger
2. Antivibration fixing holes \varnothing 25mm
3. Lifting brackets (removable, if required, after unit positioning)
4. Main electrical panel
5. Power input supply
6. Recommended functional clearances
7. Entering exchanger water recovery side
8. Leaving exchanger water recovery side
9. Water inlet user side of no pumps unit / Water outlet user side of unit with pumps (optional)
10. Water outlet user side of no pumps unit / Water inlet user side of unit with pumps (optional)
11. Hydronic assembly recovery side (optional)

Size		SC-EXC		EN-EXC	
		140.4	160.4	140.4	160.4
H (without Axitop)	mm	2484	2484	2484	2484
H (without Axitop with ECOBREEZE - optional)	mm	2510	2510	2510	2510
OD (internal exchanger)	mm	114,3	139,7	114,3	139,7
OD1 (partial recovery)	mm	114,3	139,7	114,3	139,7
A - Length	mm	5518	5518	5518	5518
B - Depth	mm	2243	2243	2243	2243
C - Height	mm	2668	2668	2668	2668
R with recovery side pumps (optional)	mm	565	565	565	565
W1 Supporting point	kg	1222	1241	1222	1241
W2 Supporting point	kg	551	558	551	558
W3 Supporting point	kg	300	305	300	305
W4 Supporting point	kg	1070	1101	1070	1101
W5 Supporting point	kg	478	486	478	486
W6 Supporting point	kg	310	314	310	314
Shipping weight	kg	3707	3777	3707	3777
Operating weight	kg	3932	4006	3932	4006

Size		SC-EXC		EN-EXC	
		140.4	160.4	140.4	160.4
Container shipping length	mm	5625	5625	5625	5625
Container shipping depth	mm	2315	2315	2315	2315

The presence of optional accessories may result in a substantial variation of the weights shown in the table. Fan diffusers are separately supplied.

Size 180.4-240.4 - Acoustic configuration : Compressor soundproofing (SC) / Super-silenced (EN)

DAB2M180 4_240 4_EXC_SC_EN_0

Data/Date 24/02/2016

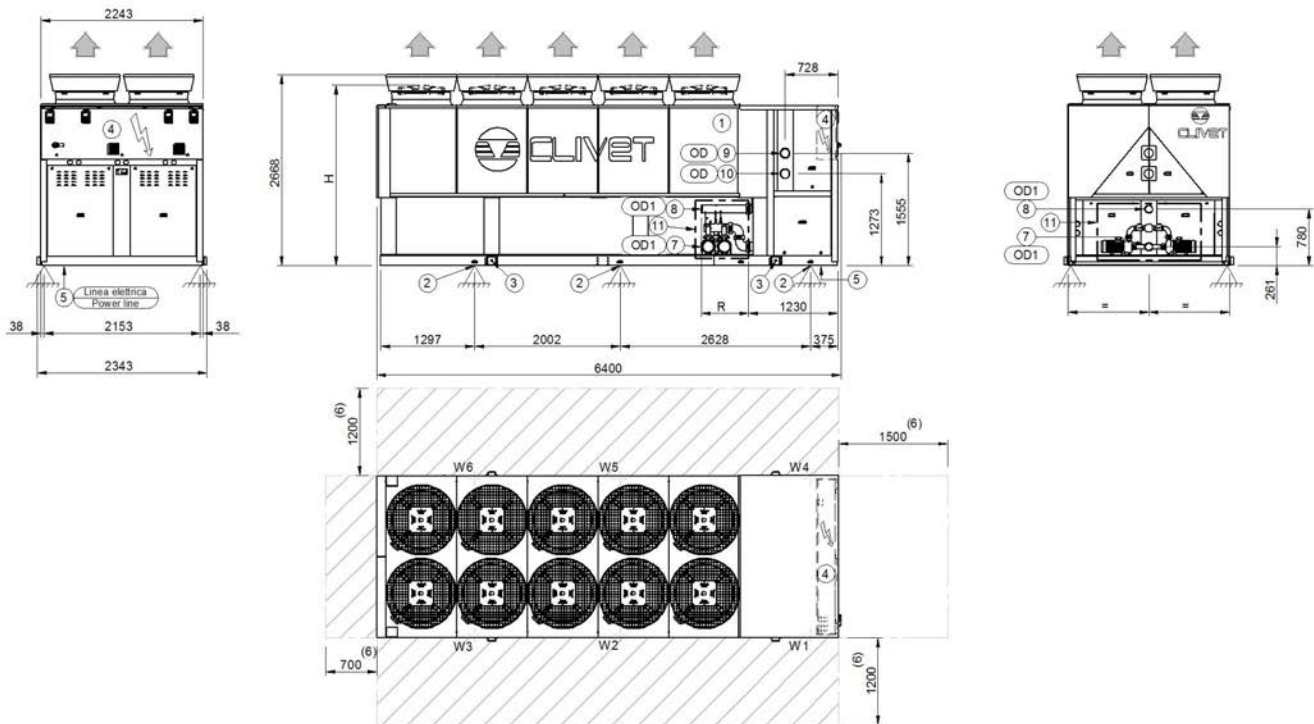

1. External exchanger
2. Antivibration fixing holes \varnothing 25mm
3. Lifting brackets (removable, if required, after unit positioning)
4. Main electrical panel
5. Power input supply
6. Recommended functional clearances
7. Entering exchanger water recovery side
8. Leaving exchanger water recovery side
9. Water inlet user side of no pumps unit / Water outlet user side of unit with pumps (optional)
10. Water outlet user side of no pumps unit / Water inlet user side of unit with pumps (optional)
11. Hydronic assembly recovery side (optional)

Size		SC-EXC				EN-EXC			
		180.4	200.4	220.4	240.4	180.4	200.4	220.4	240.4
H (without Axitop)	mm	2484	2484	2484	2484	2484	2484	2484	2484
H (without Axitop with ECOBREEZE - optional)	mm	2510	2510	2510	2510	2510	2510	2510	2510
OD (internal exchanger)	mm	139,7	139,7	139,7	139,7	139,7	139,7	139,7	139,7
OD1 (partial recovery)	mm	139,7	139,7	139,7	139,7	139,7	139,7	139,7	139,7
A - Length	mm	6400	6400	6400	6400	6400	6400	6400	6400
B - Depth	mm	2243	2243	2243	2243	2243	2243	2243	2243
C - Height	mm	2668	2668	2668	2668	2668	2668	2668	2668
R with recovery side pumps (optional)	mm	565	565	565	565	565	565	565	565
W1 Supporting point	kg	1467	1482	1569	1609	1467	1482	1569	1609
W2 Supporting point	kg	575	582	606	630	575	582	606	630
W3 Supporting point	kg	467	474	487	501	467	474	487	501
W4 Supporting point	kg	1289	1306	1386	1443	1289	1306	1386	1443
W5 Supporting point	kg	485	491	513	527	485	491	513	527
W6 Supporting point	kg	487	494	507	524	487	494	507	524
Shipping weight	kg	4479	4539	4764	4925	4479	4539	4764	4925
Operating weight	kg	4769	4830	5068	5234	4769	4830	5068	5234

Size		SC-EXC				EN-EXC			
		180.4	200.4	220.4	240.4	180.4	200.4	220.4	240.4
Container shipping length	mm	6507	6507	6507	6507	6507	6507	6507	6507
Container shipping depth	mm	2315	2315	2315	2315	2315	2315	2315	2315

The presence of optional accessories may result in a substantial variation of the weights shown in the table. Fan diffusers are separately supplied.



CLIVET SPA

Via Camp Lonc 25, Z.I. Villapaiera - 32032 Feltre (BL) - Italy
Tel. + 39 0439 3131 - Fax + 39 0439 313300 - info@clivet.it

CLIVET GROUP UK Limited

4 Kingdom Close, Segensworth East - Fareham, Hampshire - PO15 5TJ - United Kingdom
Tel. + 44 (0) 1489 572238 - Fax + 44 (0) 1489 573033 - enquiries@clivetgroup.co.uk

CLIVET GROUP UK Limited (Operations)

Units F5&F6 Railway Triangle Ind Est, Walton Road - Portsmouth, Hampshire - PO6 1TG - United Kingdom
Tel. +44 (0) 2392 381235 - Fax. +44 (0) 2392 381243 - service@clivetgroup.co.uk

CLIVET ESPAÑA S.A.U.

C/ Bac de Roda, 36 - 08019 Barcelona - España
Tel: +34 93 8606248 - Fax +34 93 8855392 - info@clivet.es

Av.Manoteras Nº 38, Oficina C303 - 28050 Madrid - España
Tel. +34 91 6658280 - Fax +34 91 6657806 - info@clivet.es

CLIVET GmbH

Hummelsbütteler Steindamm 84, 22851 Norderstedt - Germany
Tel. + 49 (0) 40 32 59 57-0 - Fax + 49 (0) 40 32 59 57-194 - info.de@clivet.com

CLIVET RUSSIA

Elektrozavodskaya st. 24, office 509 - 107023, Moscow, Russia
Tel. + 74956462009 - Fax + 74956462009 - info.ru@clivet.com

CLIVET MIDEAST FZCO

Dubai Silicon Oasis (DSO), High Bay Complex, Office N. 20, PO BOX 342009, Dubai, UAE
Tel. + 9714 3208499 - Fax + 9714 3208216 - info@clivet.ae

CLIVET AIRCONDITIONING SYSTEMS PRIVATE LIMITED

501/502, Commercial-1, Kohinoor City, Old Premier Compound, Kirol Road, Off L B S Marg, Kurla West - Mumbai 400 070 - India
info.in@clivet.com

www.clivet.com
www.clivetlive.com

A Group Company of

