

CLIVETPack²

Direct expansion high efficiency packaged rooftop
air conditioner for medium attendance areas



CSRN-XHE2 49.4 - 110.4 RANGE

AIR-AIR HEAT PUMP R-410A

Airflow from 22000 to 60000 m³/h



- ▶ High efficiency
- ▶ Energy recovery of exhaust air
- ▶ Variable airflow
- ▶ Maximum compactness
- ▶ Great versatility
- ▶ Quick installation



For many businesses, success depends on the right comfort of the users

Correct air conditioning is a fundamental component to manage various retail surfaces. Optimal temperature and humidity, air purification and proper ventilation are essential factors to ensure occupancy of these areas for both users and operators, regardless of external conditions. This is what happens in supermarkets and hypermarkets, shopping centres, stations, airports and industrial warehouses. Fresh air is even more crucial for commercial catering to control odours and vapours. Finally, also in technical facilities ventilation and air-conditioning are often essential for the correct operation of the equipment they contain.



Rooftop units are often the best solution for air conditioning the environments located in a single area

Despite their apparently low costs, split and multisplit direct expansion systems have a lot of limits in these applications. For example, they require a separate system for the treatment of the primary air. The pipes that contain the refrigerant cross the served rooms and therefore they are subject to restrictions and use limitations. From a technical point of view they cannot operate in FREE-COOLING mode, which is very efficient and convenient thanks to the generated energy savings.

The hydronic systems type is certainly more complete and versatile. They foresee different types of terminals, such as treatment unit and exposed fan coils or integrated in the furniture. Often however the cost of the system is greater, in that the more complex and more subject to installation labour.

Many of the rooftop solutions present on the market offer an evident simplification of the system, since they reduce the quantity and the quality of the site operations. On the other hand it often involves units that are not very versatile and often noisy, with limited functionality, mediocre energy performance and shorter service life.



Clivet's rooftop are even more flexible, easy to use and reduce consumptions

With more than twenty years of technological evolution, Clivet rooftop units represent the state of the art in climate control for large commercial and industrial environments.

The specialised ranges for applications with medium to high occupancy are widely used in buildings such as hypermarkets, shopping centres, multiplex cinemas and restaurants.

Their success is based on their high energy efficiency, their compact size and operation and maintenance simplicity as well as the great flexibility in selecting best suited the model for the specific installation.



CLIVETPack series for medium attendance applications

SMARTPACK

CKT/N-XHE 41 - 151 cooling only / reversible heat pump
 Nominal airflow: 2200 - 9600 m³/h
 Cooling capacity: 12 - 52 kW
 Configurations:
 CAK single fan section for full recirculation
 CBK single fan section for recirculation and fresh air
 CCK double fan section for recirculation, fresh air, exhaust, thermodynamic recovery



CLIVETPack²

CSRT/N-XHE2 15.1 - 45.2 cooling only / reversible heat pump
 Nominal airflow: 9000 - 23000 m³/h
 Cooling capacity: 49 - 134 kW
 Configurations:
 CAK single fan section for full recirculation
 CBK single fan section for recirculation and fresh air
 CCK double fan section for recirculation, fresh air, exhaust, thermodynamic recovery
 CCKP double fan section with fresh air and THOR thermodynamic recovery



CLIVETPack²

CSRT/N-XHE2 15.2 - 44.4 HSE cooling only / reversible heat pump
 Nominal airflow: 9000 - 23000 m³/h
 Cooling capacity: 48 - 147 kW
 Configurations:
 CAK single fan section for full recirculation
 CBK single fan section for recirculation and fresh air
 CCK double fan section for recirculation, fresh air, exhaust, thermodynamic recovery
 CCKP double fan section with fresh air and THOR thermodynamic recovery



CLIVETPack²

CSRT/N-XHE2 49.4 - 110.4 cooling only / reversible heat pump
 Nominal airflow: 22000 - 60000 m³/h
 Cooling capacity: 155 - 376 kW
 Configurations:
 CAK single fan section for full recirculation
 CBK single fan section for recirculation and fresh air
 CCK double fan section for recirculation, fresh air, exhaust, thermodynamic recovery
 CCKP double fan section with fresh air and THOR thermodynamic recovery



Clivet series for high attendance applications

CLIVETPack²

CSNX-XHE2 12.2 - 44.4 reversible heat pump
 Nominal airflow: 4000 - 20000 m³/h
 Fresh airflow up to 80%
 Cooling capacity: 47 - 174 kW
 Configurations:
 CCK double fan section for recirculation, fresh air, exhaust, thermodynamic recovery
 CCKP double fan section with fresh air and THOR thermodynamic recovery



Clivet series for full fresh air application

ClivetPACK² FFA

CSRT/N-XHE2 FFA 12.2-24.4 cooling only / reversible heat pump
 Nominal airflow: 3000 - 9000 m³/h
 Cooling capacity: 33 - 90 kW
 Configurations:
 CBFFA Configuration for fresh air inlet
 CCFFA Configuration for fresh air inlet with outlet



CLIVETPack CSRN-XHE2 delivers all the technological evolution by Clivet to the applications for middle attendance

The specialised ranges for applications with medium to high occupancy are widely used in industrial and commercial buildings. Their success is based on high energy efficiency, compactness, versatility, maintenance and operation simplicity.

Four main configurations providing different air flow control. Each one can be integrated by a broad range of accessories that customise the product based on the application.

CAK configuration: single fan section for full recirculation

For air conditioning applications only, without the need for air renewal. The supply fan section provides the required supply and return available static pressure.

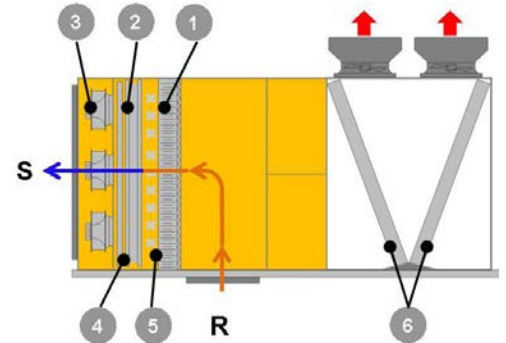

CBK configuration: single fan section for recirculation and fresh air

For applications where you need to keep the room in over-pressure, with the option of controlling a particular fresh air flow.

As for the CAK configuration, the supply fan section provides the supply and return available static pressure.

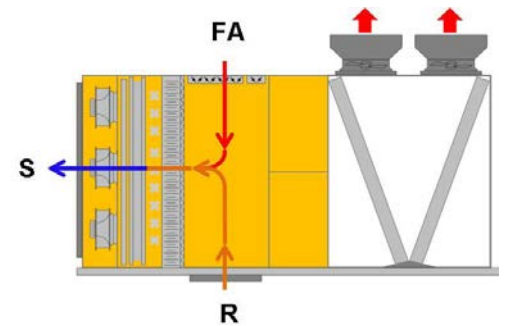

CCK configuration: double fan section for recirculation, fresh air, exhaust, thermodynamic recovery

For applications with automatic air renewal and free-cooling function control. In addition to the parts contained in the CBK configuration, the unit is equipped with an exhaust section with thermodynamic energy recovery of the exhaust air.

This air, which is still rich in energy, is mixed with the outdoor air, favouring the temperature conditions on the source side of the exchanger and improving the heating and cooling capacity.

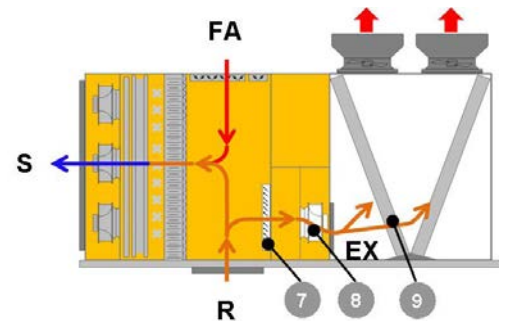

CCKP configuration: double fan section with fresh air and THOR thermodynamic recovery

For applications with automatic air renewal and free-cooling function control. In addition to the parts contained in the CCK configuration, the unit is equipped with an exhaust section with innovative thermodynamic energy recovery of the exhaust air through a dedicated THOR (THERmodynamic Overboost Recovery) exchanger.

The energy contained in the exhaust air is recovered and transferred to handling through the refrigeration circuit.

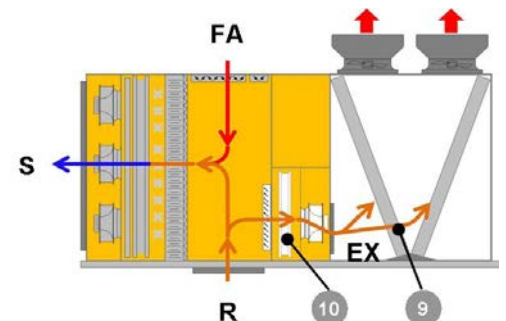

R. Return air
S. Supply air
FA. Fresh air
EX. Exhaust air

3. Supply fan section
4. Hot gas reheating exchanger
5. Electric heaters.
6. Source side exchanger
7. Exhaust damper
8. Exhaust fan section
9. Thermodynamic recovery on exhaust air
10. Thermodynamic recovery exchanger, THOR

1. G4 efficiency filters + H10 equivalent electronic filters
2. Handling exchanger

Comfort and air quality in only one product

Temperature and humidity control throughout the year

The unit acts on the overall heat load generated by the outdoor air and by the ambient loads.

The particular reversible heat pump technology is also suitable for applications in cold climates, and can be integrated where necessary to the other integrated heating options like electrical heaters, hot water coil, condensed gas with burner heating module with modulating control.

The unit can also automatically control the relative humidity in the served ambient. In cooling mode the dehumidification function can be completed by a post-heating device with hot gas recovery and on the FREE-COOLING enthalpy control. In heating mode, the steam humidifier or the evaporating heater increases the humidity introduced into the air to maintain the desired value in the ambient.

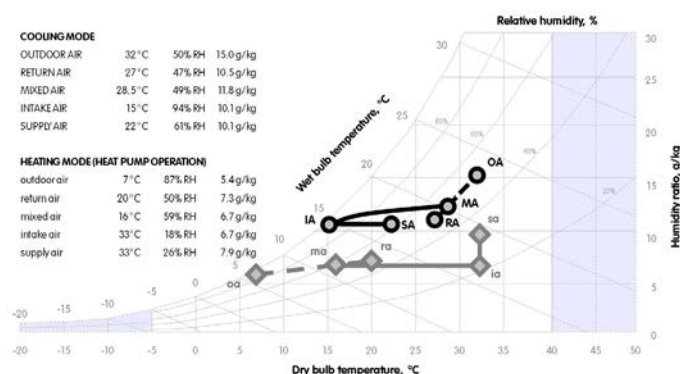

Treatment example at full load for CLIVETPack model CSRN-XHE2 49.4 in standard airflow. Outdoor airflow equal to 30% of that treated. Heating carried out with a heat pump. Unit complete with 'post-heating with hot gas' and 'vapour humidifier of 15 kg/h' options.

Automatic management of the air renewal

The automatic logic of the air renewal:

- carries out the transient steady state in all recirculation mode, to reduce its duration and quickly reach comfort conditions;
- once these conditions have been reached, it operates with fixed open damper, based on the users preferred settings;
- carry out the FREE-COOLING as soon as the external conditions allow it;
- in models fitted with air quality control, modulates the outdoor air renewal quantity, therefore guaranteeing the desired air quality with substantial energy and economic savings.

Air filtering

Air filtering is an essential function to ensure proper well-being and hygiene conditions are maintained in the areas served. This is why it is subject to special regulations based on specific applications. The units are fitted as standard with large G4 filters with low pressure drops on the treatment area.

Very high filtration efficiency

As a second stage of filtration, there are F7 high efficiency filters or innovative electronic filters available. The efficiency of the fitted electronic filters is equivalent to the H10 classification used in traditional filters, or rather the class identification such as "absolute filter". They are efficient even on fumes, fine dust, particles PM10, PM2.5, PM1, bacteria, germs and virus.

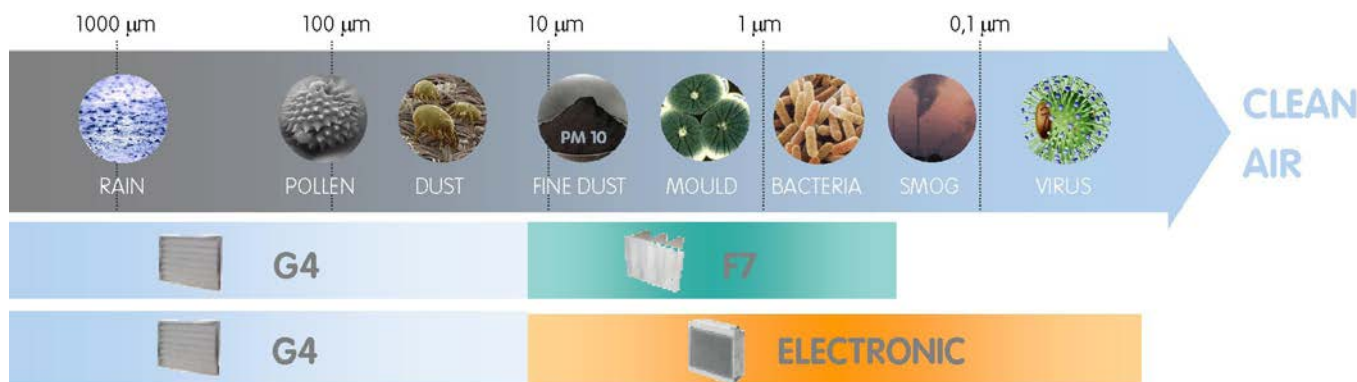

Automatic control of the air quality

When the area is occupied in partial mode, a minor air change is necessary. The air quality probe (which is sensitive to the CO2 tracer) is positioned on the return of the served ambient and automatically determines the opening of the outdoor air damper to give the correct renewal and avoid waste.

Similarly, the probe is also sensitive to VOC (Volatile Organic Compounds) also acts in the presence of tobacco smoke, formaldehyde (for example from solvents, deodorants, glues, paint, detergents), cooked foods.

High energy efficiency within the annual cycle

Increases the building value

The high efficiency reduces the complex primary energy requirements and the CO2 emissions compared to traditional solutions. It follows the improvement of the energy class of the building and therefore its value on the property market.

It is often possible to access the foreseen benefits to promote the use of the unit at low consumption.

The small consumptions also reduce the environmental impact of the system, further improving the public image on this sensitive issue.



Ventilation electronically controlled

An important expense entry in the systems management costs is represented by the energy consumption for ventilation, then the research for the correct operating conditions on the systems that forces them to carry out long and costly operations.

The ventilation technology makes it possible to cut back on both of these operational costs: it runs on fans that are coupled directly to electronic control brushless motors, and the control logic offers additional savings.

Versatility of reversed blades rotor

This particular type of rotor offers a wider field of operation compared with a traditional forward curved blade fan. When necessary, this can supply high static pressures simply by varying the number of revolutions. The accurate balancing and the self-lubricating bearings ensure its rotating stability over time.



The efficiency of the electronic controlled motor

The external rotor electric motor is driven by the continuous magnetic switching of the stator. The advantages are:

- the lack of brushes and the particular power supply increase efficiency by 70%;
- even the life cycle increases, thanks to the elimination of the brushes' natural abrasive erosion effects;
- the electronic control also includes a "soft start" solution, which drastically reduces the starting current of the fan and limits even more the system's electrical commitment.



Advantages of direct coupling (plug fan)

The motor's rotation is transmitted directly to the rotor, without the use of transmissions (belts and pulleys):

- the transmissions' inefficiencies are eliminated;
- the transmissions' wear and maintenance is eliminated.

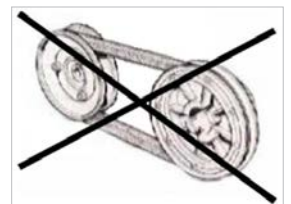

Efficiency of the ventilation system increases by 30%

The comprehensive ventilation system, made up of rotor and motor, is therefore very versatile and efficient.

Consumption is 30% lower than a ventilation system of the same capacity used by traditional units available on the market.

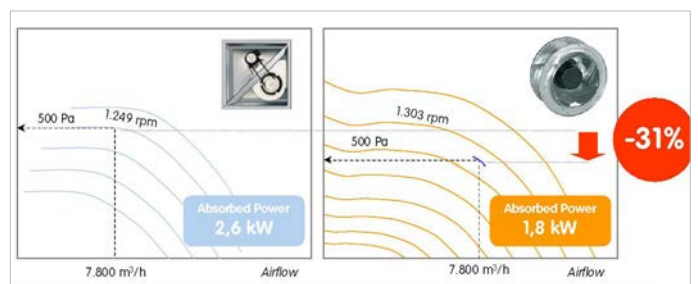

Electrical power absorbed by electric motor, data constructor - Example, referred to flow of 7.800 m3/h with 500 Pa external static pressure.

Automatic management of the air flow

Standard mode

The air flow supply remains constant in all heat load conditions and operation modes.

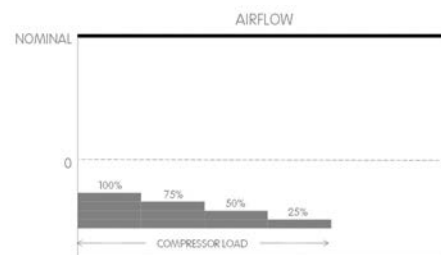

ECO mode

The air flow supply remains constant at varied heat loads and is shutdown when the load is fulfilled (dead zone).

To further increase the energy savings in this condition, it is also possible to set less demanding operation setpoints for the unit in respect to the standard mode.

This function is indicated for the thermal maintenance of the served area in case it is temporarily not used, which can for example occur at night.

The ECO mode can be activated:

- manually;
- automatically by the functionality of daily and weekly programming supplied as standard;
- automatically by means of the Clivet supervision System.

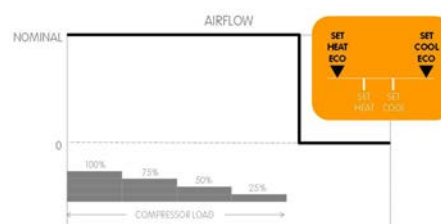

Variable airflow

The air flow supply varies depending on the heat load, up to a minimum value compatible with the distribution system and the chosen air diffusion.

The ventilation remains active even when the load is fulfilled (dead zone).

This option allows a further energy savings.

- The movement of the air is always active during the operation of the rooftop unit.
- It determines an annual energy consumption comparable or even greater than the compressors.
- The reduction of 20% of the flow generates a saving of 50% on energy absorbed by the ventilators.
- With a reduction of the flow equal to 40%, the saving for ventilation exceeds 70%.
- The variable airflow can therefore lead to a saving of 30% on an overall electrical consumption of the unit.

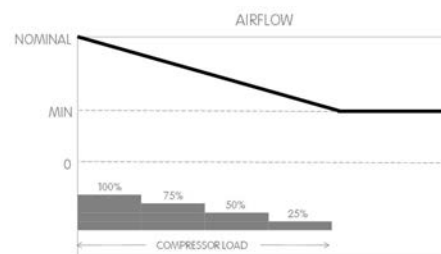

Applications with textile channels

The fans with electronic control allow choosing the preferred ramp for fan start-up.

The units are therefore suitable for majority of the applications with textile channels for the air distribution.

This versatility remains valid in each management mode of the flow (standard, ECO, Variable flow).



The right air flow for every type of system

By controlling the fan speed, the airflow can be varied and the static pressure capacity can be adapted to the system pressure drop, making the unit start-up particularly simple. The adjustment or modification of the transmission is no longer required as the ventilation system will adapt itself to the system. The possibility to modify the fan start-up ramp makes this unit suitable for most applications with textile air distribution ducting.

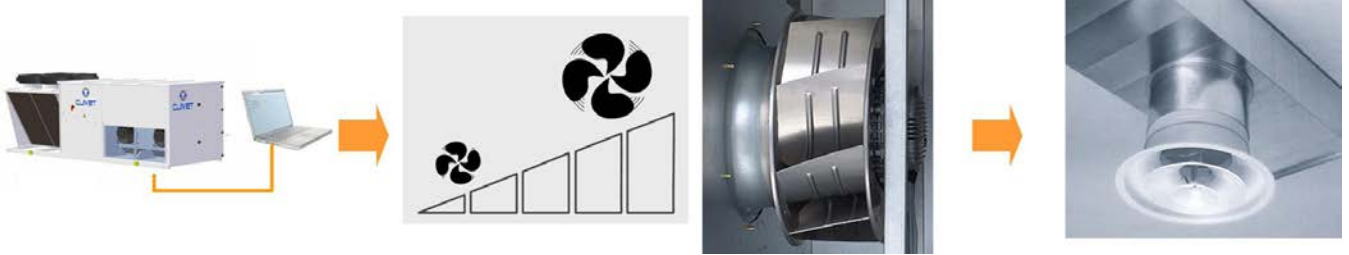

Ambient pressure control

The ambient pressure control device compares the return pressure with the external pressure and compensates any variations by acting on the outdoor air damper.

This way, the unit maintains the relevant ambient pressure desired by the user, who can choose between the overpressure, depression or equal-pressure.

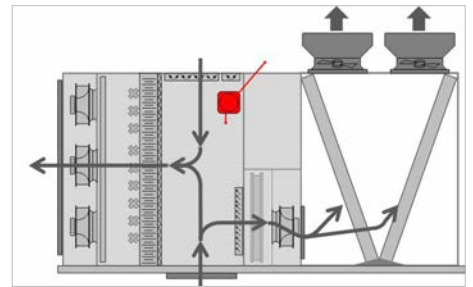

The room pressure control device is fitted as standard in the units with extraction and exhaust (Clivet reference code CCK and CCKP)

FREE-COOLING

As soon as the external conditions allow it, the unit is capable of automatically activating the FREE-COOLING mode, which, keeping the compressors off and drawing in suitably filtered outdoor air allows to cool the served room. This operating mode is especially useful in spring and autumn or in case of high ambient loads. It allows substantial reduction of the unit energy consumption and compressors.

To obtain the maximum energy saving, the FREE-COOLING model is activated even when it is not sufficient to supply all the capacity requested. In this case the integration cooling capacity is supplied from cooling by means of compressors.

At reduced load, or even with rigid outdoor air temperatures, the cooling capacity in FREE-COOLING mode is controlled by means of a modulation of the outdoor air damper.

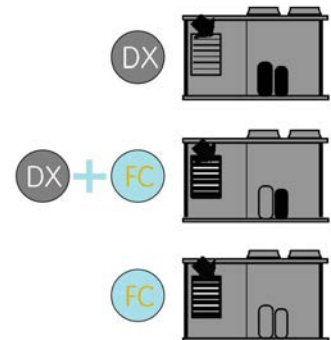

Min. outdoor air damper

Together with the FREE-COOLING damper, it realizes the air renewal in the space. Its size provides more accurate control for minimum air renewal flow rates. It guarantees the lowest possible noise levels in the room at low air crossing speeds, even with minimum openings.

Economic and energy saving throughout the entire life-cycle

The electronic filters reduce the energy necessary for ventilation

The highest filtration efficiency is obtained with practically no pressure drops.

This depends on the metal pre-filter that is found upstream of the plate and withholds the coarse particles. Moreover, the metal pre-filter homogeneously distributes the air flow and contributes to the containment of the magnetic field generated during operation.

The energy for the ventilation is thus reduced by more than 10%.

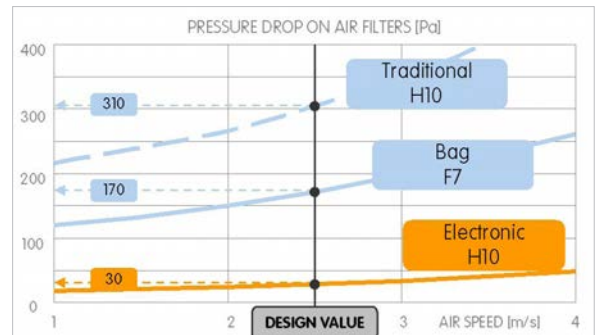

Part load efficiency determines the seasonal efficiency

The system is required to generate maximum capacity only for a short amount of time.

Therefore, it is essential to have the maximum efficiency under part-load conditions.

This is the only way to actually reduce overall yearly consumptions.

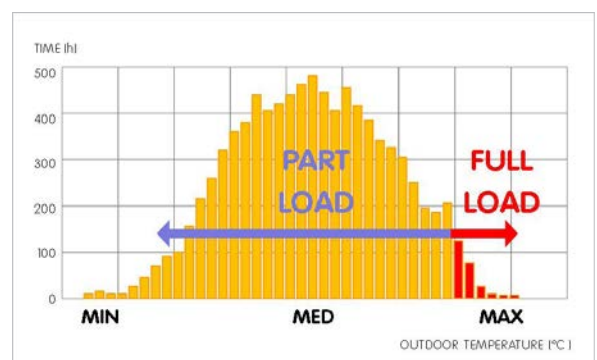

Modular Scroll technology boosts performance at part load

The unit uses high efficiency Scroll compressors. The advantages are:

- compressors manufactured in large ranges, with strict quality controls and maximum reliability thanks to the high production volumes;
- the refrigerant circuit uses two compressors, almost always of different sizes in order to obtain more control steps. This way, only the necessary energy is supplied;

All sizes have a double refrigeration circuit with compressors connected in tandem, for greater reliability and safe operation.

THE SEQUENTIAL DEACTIVATION OF THE COMPRESSORS INCREASES EFFICIENCY



Doubled efficiency

The heat exchange surface is sized for full capacity operation. Under part load condition, some compressors are automatically deactivated. Under this condition, in fact, the compressors in operation make use of a much larger surface.

This entails a reduced condensation temperature and an increased evaporation temperature. This way, the compressor capacity consumption is reduced with respect to the yield thereby increasing the overall efficiency of the unit.

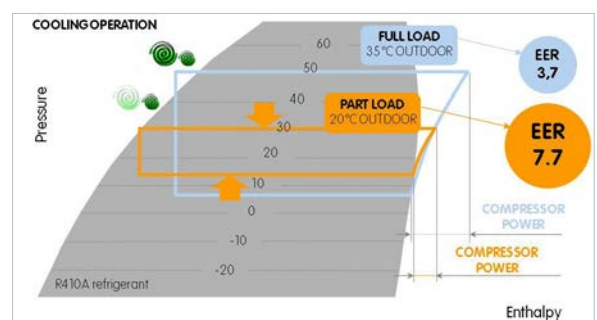

Example referred to CSRN-XHE 49.4 in the all recirculation operation

Set-point automatic compensation

With this function as standard, the temperature set-point can automatically vary in view of the outdoor temperature and of the User settings:

- further increases the energy saving;
- reduces the temperature difference between the outside and the served area, increasing the user comfort.

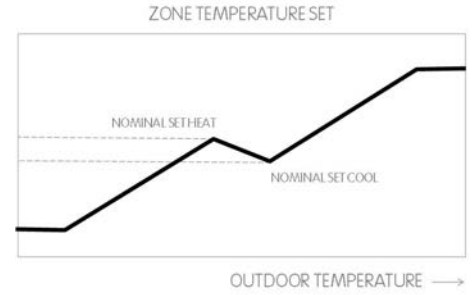

Stable and reliable operation

The electronic expansion valve (EEV) adapts rapidly and precisely to the actual load required for usage, allowing stable and reliable adjustment in comparison with mechanical thermostatic valves (TEV). This results also in a further increase in efficiency and longer compressor life. Through control of overheating, it also prevents hazardous phenomena for the compressors, such as overtemperature and return of fluids, thereby further increasing efficiency and durability.

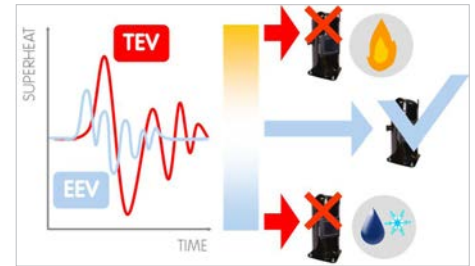

High efficient refrigerant

R410A is the mix of two refrigerants used in equal parts: R32 that supplies the heating capacity and R125 that controls the flammability. It is a chlorine free refrigerant (HFC) with numerous advantages:

- ODP (Ozone Depletion Potential) = 0;
- high volumetric effect thanks to the high coefficient global thermal exchange and to the pressure variation (glide) which is almost nil during the evaporation phase;
- elevated density and efficiency, with greater compactness of the refrigeration circuit and therefore the responsible use of materials and small refrigerant quantity, for a reduced environmental impact.

R-410A

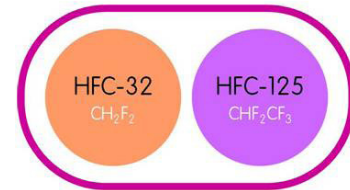

Energy recovery on the exhaust air

The air renewal in buildings is indispensable for checking the air quality and comfort. The movement and the treatment of the outdoor air generate added costs in the realisation of the system and energy consumption in its service life. For this reason the energy recovery devices on ejected air are widely used. Local standards and provisions regulate the application.

Rooftop in CCK and CCKP configuration are equipped with the energy recovery on the exhaust air

CCK - Thermodynamic energy recovery

Thermodynamic recovery is also included in the CCK configuration and uses the technology of refrigeration circuit with direct expansion.

The unit is equipped with an electronically controlled exhaust fan section that automatically controls the amount of air to reject.

The exhaust air flow is, in fact, directed onto the external finned coil exchanger which is accordingly thermally favoured in its operation cycle. The recovered energy is transferred by the handling exchanger and therefore transferred directly to the supply air.

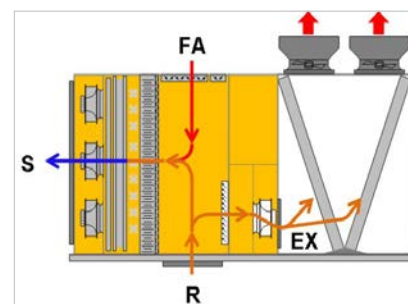

CCKP - THOR thermodynamic energy recovery (Thermodynamic Overboost Recovery)

The innovative THOR recovery (Thermodynamic Overboost Recovery) is always included in the CCKP configuration and uses direct expansion refrigeration circuit technology.

The unit is equipped with an electronically controlled exhaust fan section that automatically adjusts the amount of air to reject. The exhaust air flow is directed by the exchanger dedicated to recovery, which is an integral part of the refrigeration circuit. The amount of recovered energy is easily measurable like the static heat recovery.

Winter and summer energy recovery provides a dual positive effect: it increases the capacity and offers a significant energy savings.

The main benefits of the energy recovery:

- it increases the total unit efficiency;
- it eliminates the greater part of electrical power consumption for the ventilation of passive recovery devices, which also significantly reduce the effective amount of recovered energy;
- in terms of heat pump operation, it reduces the formation of ice on the exchanger and therefore the number of defrost cycles. Thereby increasing operation continuity and overall system efficiency;
- it is also effective for cooling operations, especially in continental and temperate climates where passive recovery device output is essentially negligible due to a low outdoor and indoor temperature difference and enthalpy;
- it keeps the unit compact and simplifies its positioning.

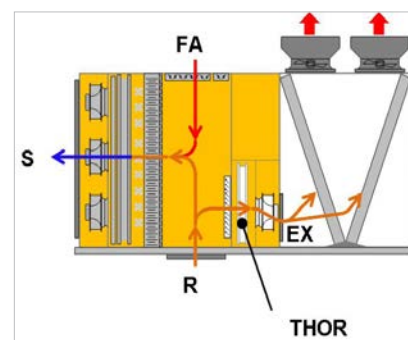

Energy considerations

The physical principle of thermodynamic energy recovery differs from the principle that manages passive recuperators. Therefore, efficiency indicators differ as well:

- the performance of passive recovery devices, which are air-air heat exchangers, are measured by the heat exchange efficiency. These values must be combined with the performance of the refrigeration circuit to obtain the overall performance of the unit;
- the performance of the heat pumps is measured with the coefficient of performance (COP). The contribution of the thermodynamic energy recovery is in this case already included in the overall performance of the unit that can thus be inserted in the calculations of the different procedures of energy certification, both compulsory and voluntary;
- THOR energy recovery is based on the heat pump technology, making it possible to determine the recovered heating capacity on the dedicated exchanger, and therefore an efficiency value. It can accordingly be included in the calculations required by the various compulsory and voluntary energy certification procedures.

Energy recovery from food refrigeration

Modern supermarkets and hypermarkets consume massive amounts of energy every year on food storage. With most of these systems, the heat that they produce is released outdoors through air-cooled condensers.

In winter, energy recovery from cold storage offers new possibilities for energy savings, as it increases the efficiency of the entire air conditioning and food storage system.

Evolution and optimization of the external ventilation

A new diffuser on the fans in the outdoor section optimizes air distribution, with a considerable increase in efficiency.

The amount of electric power input by the motor leads to an equally greater air flow rate till 8%, which improves the energy exchange with a considerable increase in the heating and cooling output.

Also, the special aerodynamic shape lowers sound emissions by -3dB(A), to the full benefit of indoor and outdoor sound comfort.



Electronic control ECOBREEZE technology

With ECOBREEZE, the electric motor with an external rotor is driven by the continuous magnetic switching of the stator, deriving from the integrated electronic control.

The advantages are:

- 70% increase in efficiency thanks to the brushless technology and the special electricity supply;
- increase in the working life, thanks to the elimination of the brush wear;
- Reduction in the electrical consumption by the system, thanks to a drastic reduction of the inrush current for the fans obtained using the integrated 'Soft starter' function.

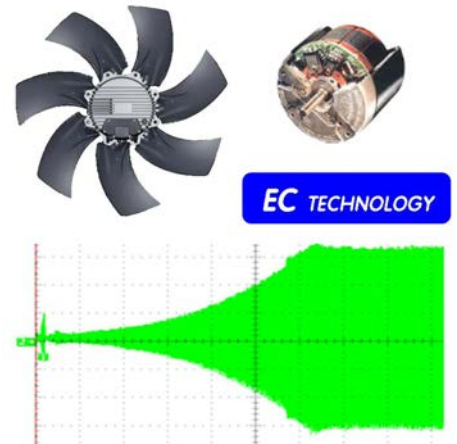

Renewable energy heat pump technology

The electric Heat pump technology promotes and provides incentives by the European Union with specific standards, such as the EU Directive 2009/28/CE of April 23rd 2009 that recognises ambient heat as a renewable source.

Compared to a combustion system, the electric heat Pump allows:

- energy saving and reduction of the CO₂ emissions by an average of 50%;
- use of electric energy, increasingly produced through alternative and renewable sources;
- operation and reduced maintenance reliability;
- no fossil combustion and therefore absence of chimney, absence of periodical controls on the emissions in the ambient and no local production of fine dust;
- cost reduction of first investment with the reversible models that use a single system for both heating and cooling.

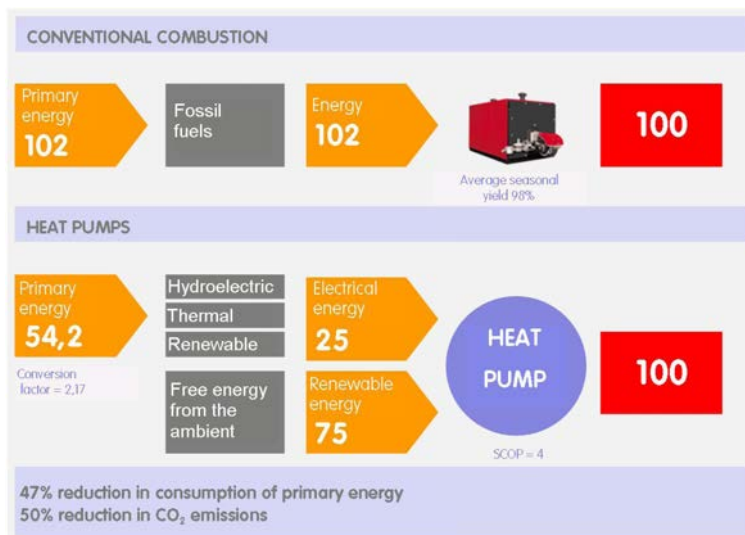

High efficiency heating solutions

The reversible heat pump model is able to also operate with particularly rigid external temperatures. In many locations this condition is determined only for short periods during the effective use of the system. The use of the electric resistance (I) allows to maintain the advantages of the single block solution, in terms of design simplicity and system rational. The electric resistances can in fact intervene automatically like any thermal integration, or with the outdoor air pre-heating operation, before heating from the heat pump.

Alternately, the hot water coil (II) option extends the operating field of the unit to even colder climates. When necessary, it can also heat-up the external air before the treatment or integrate the capacity delivery from the heat pump. It can also fully substitute it in automatic mode, below an outside temperature value chosen by the user. For example, after having estimated the different supply costs of the energy sources in the individual application situations. In the event the heat pump is damaged, the hot water coil is automatically activated in emergency mode.

Another available solution is the heating module with combustion burner (III). It is the solution frequently used in very cold climates. As the hot water coil performs the task of heat integration needed in the operation range of the heat pump, it can automatically become the only heat source with an outdoor temperature below the value chosen by the user and is automatically activated in emergency mode. Unlike systems powered by a thermal power station it does not require the distribution of hot water outside of the building: this simplifies the system, eliminates pumping consumption and avoids the use of devices and controls against the risk of freezing.

In very cold climates it is also necessary to foresee the 'Application for low outdoor temperature' option. The operation fields of the different heating options are shown separately.

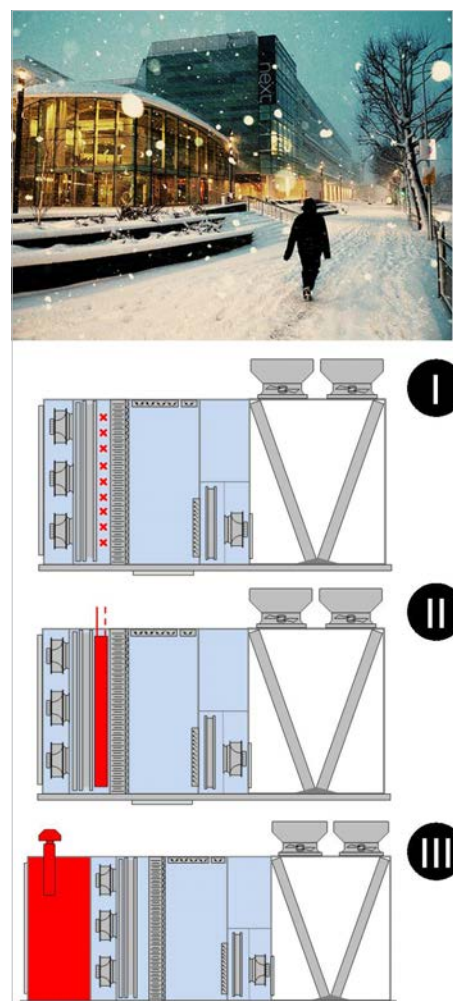

Combustion heating modules

The following kinds of modules are available with different heating capacities:

- gas heating module with 2-stage control: both an efficient and cost-effective solution for its low initial investment costs;
- gas-operated condensation module with modulating control: extremely efficient solution that, thanks to the condensation and accurate control, always allows for top comfort levels. It is the best choice for the overall cost reduction throughout the lifespan of the system.

Criteria to determine the size of the combustion heat generator

The heating capacity that needs to be installed is determined based on the conditions the unit will work under, such as the outdoor air temperature, internal loads and energy losses of the building.

The size of the heat generator is based on one of the modes below:

- hybrid, as an integration for the heat pump to maintain the heating capacity supplied as the outdoor temperature drops;
- bivalent, to fully replace the heat pump when the outdoor temperature drops below the operating limits or the latter is not available.

In hybrid mode, the heating capacity required is met by the heat pump and the additional resource, whose capacity may be smaller than the capacity provided by the heat pump.

In bivalent mode, as well as serving as an additional resource, the thermal resource must fully replace the heat pump. Therefore, the chosen heating capacity must be higher or identical to the one provided by the heat pump.

The unit control manages the operation of the thermal resource by giving priority to the heat pump, which also carries out the exhaust air thermodynamic recovery whenever required (configuration with exhaust air energy recovery).

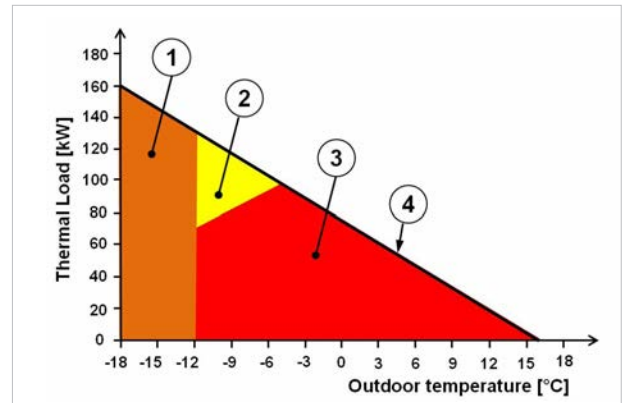

The thermal load increases as the outdoor temperature decreases.
 Ex: CSRN-XHE2 49.4 CAK configuration.
 Condensing gas module with modulating control 96kW (Hybrid function)
 Condensing gas module with modulating control 200kW (bivalent function)

1. Bivalent function
2. Hybrid function
3. Heat pump
4. Thermal load line

Winter thermodynamic energy recovery for unit with hot water coil or gas module

The refrigerating circuit of this unit is of reversible type. Carries out the thermodynamic energy recovery, automatically activating only one compressor that, thanks to the high exchange surface available, operates with highly efficient energy. In respect to the passive recuperators:

- delivers a notably superior thermal and stable capacity in time. This reduces the capacity requested from the hot water coil or gas module;
- eliminates most of the consumption for ventilation caused by the high pressure drops of the passive exchangers. Therefore, further increases the overall efficiency.

Reliability and saving throughout the entire life-cycle

Great system simplification and increase in reliability

The single block solution significantly reduces the initial system costs in respect of the traditional solutions based on the hydronic systems with separate production, for example by means of chillers and boilers, or on direct expansion systems with fresh air.

Most of the normal engineering activities are in fact created by Clivet inside the unit:

- component selection and dimensioning;
- water and mechanical connections;
- electric and control wiring;
- functional test.

Only the air distribution ducts connection and the power supply of the unit are provided by the Customer.

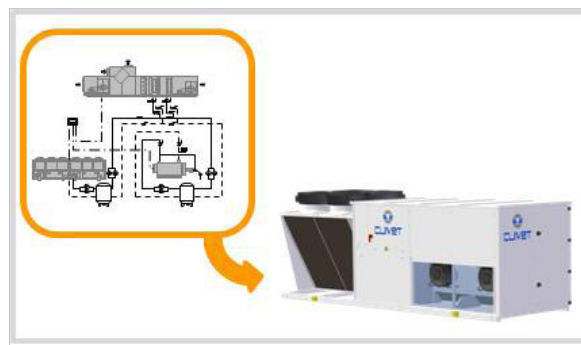

The air distribution depending on the installation

Great flexibility of set-up on site, the air supply and return of these units can be from the side or bottom.

The configuration is selected during offering, choosing the supply and return set-up for the air duct connections, and to adapt the unit to certain architectural design constraints or make it easier to replace existing systems.

Standard Version

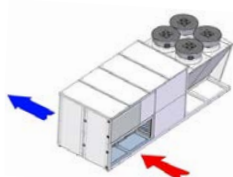

Other available versions

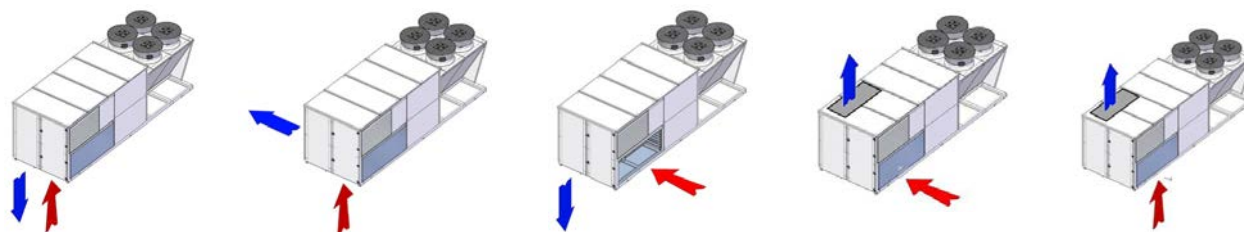

Demand limit

The partial or total activation of the compressors - and the heating electric resistance where present - can be disabled to limit the overall electric capacity absorbed.

The external signal is of analogical type 0-10 V / 4-20 mA. The greater the signal, the lower the capacity that the unit is enabled to deliver, activating the compressors and the electric elements.

The Demand Limit function does not act on the control or on the ventilation, which are therefore always guaranteed, nor on the remaining resources such as hot water coil or the gas heating module.

The Demand Limit function on the reversible heat pump models can affect any automatic defrosting cycles. In these conditions, the user can therefore decide to limit its activation.

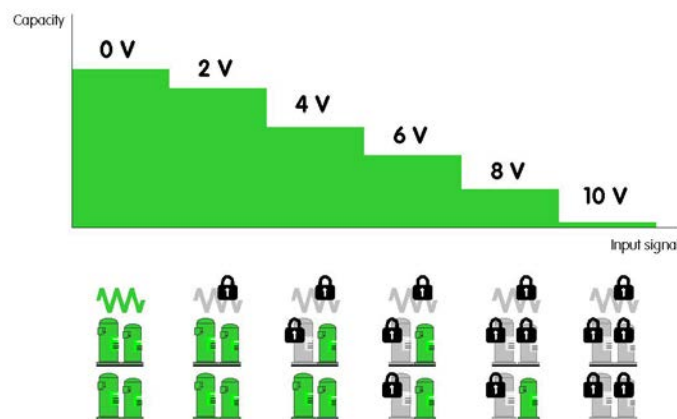

Airflow configuration: S= supply R = return

The represented number of compressors constitutes an indicative example

Operating completely automatic

The microprocessor control automatically manages operation according to the maximum efficiency criterion and includes many safety and alarm management functions.

It also includes advanced functions, such as daily and weekly programming and automatic maximum power consumption limitation (demand limit).



Simple and intuitive user interface

The remote control with user interface (for wall mounting) is supplied as standard and it can be easily used also by not specialized personnel. The connecting cable (not supplied) has a double function of serial communication and power supply.

Among the main functions it allows to:

- unit switching on and off;
- daily/weekly start-up or power-off programming of the unit and the Comfort or ECO (energy saving) or Ventilation-only mode;
- display the alarm code and the unit stata;
- management of the main operating parameters (password-protected);
- selective key lock, unlocked with password.

The temperature and humidity measurement is made by probes into the unit: the remote control can therefore be installed also inside the technical control compartment. When the centralised supervision system or an other remote control device is provided, the unit can be supplied without the remote control with the user interface.

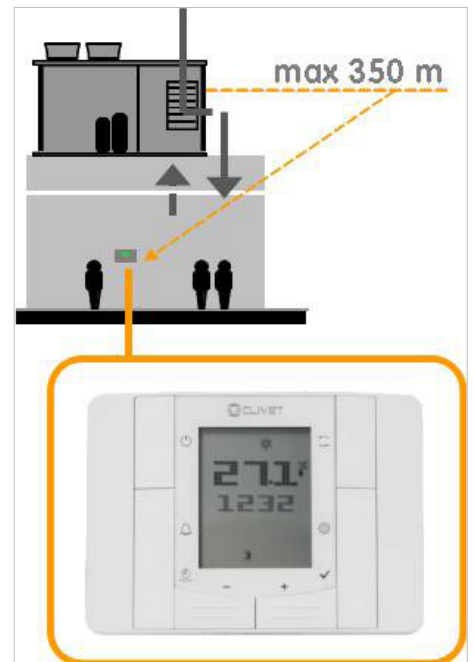

Remote system management

The unit can be remotely managed by:

- remote control user interface, supplied standard;
- Clivet Master System, device to manage a group made of max 8 units;
- Clivet P-Matic, supervision system able to be interfaced to other users;
- free contacts supplied as standard, to remotely control the main functions and to display alarms and operating stata;
- different communication protocols to exchange information with the main supervision systems by serial line.



Coils protected against the formation of ice

The particular technology of the heat pump developed by Clivet guarantees its continued and reliable operation.

The ICE PROTECTION SYSTEM device prevents icing on the base of the external exchanger during winter operation, thanks to a special subcooling circuit. This prevents damages caused by freezing.



Smart management of defrosts

The automatic defrost cycles on the remaining external exchanger surface are managed in predictive mode, reducing both the frequency and the duration. The built-in electronics analyses not only the external conditions, but also the evaporation pressure variation in the exchanger.

The standard defrosting cycle management activates one circuit at a time without stopping ventilation. This reduces the time required for defrosting and prevents the introduction of too cold air in the served area, maintaining comfortable conditions for the users.



Composite panels with sandwich structure

The "sandwich" type panelling is lighter and sturdy. They reduce the thermal dispersions and therefore the energetic consumptions.

They are composed of a double steel wall that contains the insulating material, made of injected polyurethane. They are equipped with seal gasket for the whole length of the perimeter.

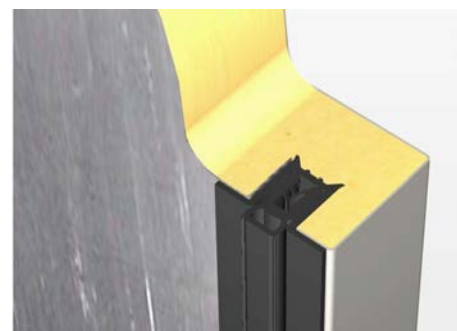

Easy access for maintenance

The internal components are positioned based on type, in an homogeneous area with easy and safe access, thanks to the hinges that support the larger sized doors to their adjustable hinges and to the device that blocks the access panel to the electrical control board in open position and helps protect the maintenance operator from the rain.



Simplified maintenance

Thanks to the local plug RJ45 available outside the unit, the authorised technical personnel will be able to undertake all the operations to control and maintain the unit by:

- laptop computer equipped of Ethernet network cable and of web browser (like for example Firefox, Explorer, Chrome, Safari);
- service interface with extensible cable of 1.5 m as available option.



Controlled power supply

Proper power supply ensures optimal unit operation and protects its many electrical components.

The phase monitor, standard supplied:

- controls the presence and exact sequence of the phases;
- check for voltage anomalies (+/-10%);
- automatically restarts the unit as soon as the proper power supply is restored.



Furthermore it is possible to choose the multifunction phase monitor as optional adding to the previous functions also the manual setting of the overvoltage, undervoltage and slot limit values, over which the unit is automatically switched off.

Unit configuration

Model	Version	Size							
CSRN-XHE2	CAK - Full recirculation	49.4	54.4	60.4	70.4	80.4	90.4	100.4	110.4
	CBK - Fresh air								
	CCK - FREE-COOLING, thermodynamic recovery								
	CCKP - FREE-COOLING, THOR thermodynamic recovery								

Functionalities	Air supply and return		
	M0 - R0 Standard unit 	M3 - R3 Option 	M0 - R3 Option
	M3 - R0 Option 	M5 - R0 Option 	M5 - R3 Option

Filtration	G4	G4 + F7	G4 + FES H10
------------	----	---------	--------------

Auxiliary heating	Heat pump standard unit	Heat pump and electric heater option	Heat pump and hot water coil option	Heat pump and combustion module option
-------------------	-------------------------	--------------------------------------	-------------------------------------	--

Configuration options		
<ul style="list-style-type: none"> • FC - Thermal FREE-COOLING (standard for CCK and CCKP configuration) • FCE - Enthalpic FREE-COOLING • CPHG - Hot gas re-heating coil • F7 - High efficiency air filter • FES - Electronic filters • PSAF - Clogged filter differential pressure switch air side • EH - Electric elements • CHW2 - Two-rows hot water coil • 3WVM - Modulating 3-way valve • GD, GC - Combustion heating module 	<ul style="list-style-type: none"> • HSE - Immersed electrodes steam humidifier • HWS - Steam humidifier with disposable water • VENH - High static pressure fans • PAQC - Air quality probe for the CO2 rate check • PAQCV - Air quality probe for the CO2 and VOC rate check • SERM - Outdoor air motorized ON/OFF damper only (CBK) • SFCM - Modulating motorized FREE-COOLING damper (only CBK) • SFCEM - FREE-COOLING and min. outdoor air motorized and modulating dampers (only for CCK and CCKP configuration) • MHP - High and low pressure gauges 	<ul style="list-style-type: none"> • PCMO - Sandwich panels of the handling zone in M0 fire reaction class • DESM - Smoke detector • CREFP - Fan consumption reduction device of external section at variable speed (phase cutting) (standard). • CREFB - ECOBREEZE external section fans consumption reduction device • MOB - Modbus serial communication module • LON - LonWorks serial communication module • BACIP - BACnet-IP serial communication module • MF2 - Multifunction phase monitor • PFCP - Power factor correction capacitors (cosfi > 0.9)

Accessories separately supplied			
SIX - Service interface	CLMX - Clivet Master System	AMRX - Rubber anti-vibrating dampers	RCX - Roof curb

Standard unit technical features - Configuration with single fan section for full recirculation (CAK) and for recirculation and fresh air (CBK)

Compressor

Hermetic orbiting scroll compressor complete with motor over-temperature and over-current devices and protection against excessive gas discharge temperature. Fitted on rubber antivibration mounts and complete with oil charge. The oil heater is automatically activated to prevent the oil from being diluted by the refrigerant when the compressor stops. The compressors are connected in TANDEM on a single refrigeration circuit and have a biphasic oil equalisation.

Structure

The support base is assembled with a painted galvanized steel frame. The internal structure is made of zinc - magnesium bent galvanized steel. The alloy Zn - Mg allows an excellent corrosion proofing thanks to the galvanic protection typical of the combination zinc - magnesium.

Panelling

Sandwich panels in the air treatment section with dual walls in steel sheet metal with polyurethane insulation (40 kg/m³), thickness of outer sheet metal 6/10 mm galvanized and painted using polyester powders colour RAL 9001, polyurethane thickness with thermal conductivity coefficient 0.022W/mK, thickness of internal sheet metal 5/10 mm hot galvanized. The panel is also provided with a PVC profile for thermal insulation and a EPDM rubber gasket that ensures the hermetic seal. All panelling can easily be removed to allow complete accessibility to internal components.

Internal exchanger

Direct expansion finned coil exchanger made with copper pipes placed on staggered rows mechanically expanded to better adhere to the fin collar. The fins are made from aluminium with a corrugated surface and adequately distanced to ensure the maximum heat exchange efficiency.

External exchanger

Direct expansion finned coil exchanger made with copper pipes placed on staggered rows mechanically expanded to better adhere to the fin collar. The fins are made from aluminium with a corrugated surface and adequately distanced to ensure the maximum heat exchange efficiency. A correct power supply to the expansion valve is ensured by the subcooling circuit; this circuit also prevents the formation of ice at the base of the heat exchanger during winter operation.

Fan

Internal section

Plug fans without scroll with reverse blades driven by electronically-controlled "brushless" dc motors with direct coupling. No transmission sizing is needed. The motor is in compliance with ErP 2015 according to Regulation UE 640/2009. Class IE4.

External section

Helical fans with die-cast aluminium blades, directly coupled to a three-phase electric motor with external rotor, with built-in thermal overload protection, IP 54 index of protection. Housed inside an aerodynamically shaped nozzles to increase efficiency and minimise noise levels; fitted with safety grills.

Refrigeration circuit

Refrigeration circuit with:

- refrigerant charge;
- sight glass with moisture and liquid indicator;
- high pressure safety pressure switch;
- low pressure safety switch;
- filter dryer;
- electronic expansion valve;
- non-return valve;
- 4-way reverse cycle valve;
- liquid receiver;
- liquid separator;
- high pressure safety valve;
- low pressure safety valve.

Filtration

Outdoor air inlet side and environment return side

Pleated filter for greater filtering surface, made of a galvanized sheet frame with a galvanized and electric-welded protective mesh, and regenerable filtering media made from polyester fibre sized with synthetic resins. G4 efficiency according to CEN-EN 779 standard (Eurovent classification EU4/5 - separation average 90.1% ASHRAE 52-76 Atm). Self-extinguishing type (flame resistant class 1 - DIN 53438).

Drain pan

Internal section

Inox steel AISI 304 condensate collection tray with anti-condensate insulation, welded, fitted with drain pipe.

Electrical panel

The electrical panel is positioned inside the units, with access through a swing door that is opened by a special key.

The capacity section includes:

- main door lock isolator switch;
- compressor circuit breaker;
- compressor power supply remote control switch;
- fan motor thermal protections of internal and external section;
- circuit breaker to protect auxiliary circuit.

The microprocessor control section includes:

- compressor overload protection and timer;
- Demand limit;
- potential-free contacts for remote ON-OFF, cumulative alarm, fire alarm inlet, fan status, compressor status, summer/winter mode;
- phase monitor;
- RJ45 located on the unit's outer surface for inspection and maintenance operations.

Remote control with user interface:

- switching the unit on and off;
- daily/weekly start-up or power-off programming of the unit and the Comfort or ECO (energy saving) or Ventilation-only mode;
- manual change of the operating mode (heat or cool) and / or of the temperature setpoint;
- display the alarm code and the unit data;
- management of the main operating parameters (password-protected);
- selective key lock, unlocked with password.

Accessories

- Downward air supply
- Downward air return
- Upflow air supply
- Two-rows hot water coil
- Modulating three-way valve
- Modulating two-way valve
- Hot gas re-heating coil
- Combustion heating module
- Recovery exchanger from food refrigeration
- Immersed electrodes steam humidifier
- Water to waste evaporating wet-deck humidifier
- Electric heaters.
- Air quality sensor for CO₂ p.p.m. control (not available for CAK configuration)
- Air quality sensor for CO₂ and VOC p.p.m. control (not available for CAK configuration)
- Outdoor air motorized on/off damper (only for CBK configuration)
- Modulating motorized FREE-COOLING damper (optional for CBK configuration, standard for CCK and CCKP configuration)
- Modulating motorized FREE-COOLING damper and min. outdoor air motorized on/off damper (only for CCK and CCKP configuration)
- High efficiency F7 air filter
- Electronic filters
- Differential pressure switch for dirty air filters
- Serial port RS485 with Modbus protocol
- LonWorks serial communication module
- BACnet-IP serial communication module
- Multi-function phase monitor
- Service interface (accessory separately supplied)
- Power factor correction capacitors (cosφ > 0.9)
- Enthalpy FREE-COOLING (only for CCK and CCKP configuration)
- Constant supply airflow
- Variable airflow
- Device for consumption reduction of the external section ECOBREEZE fans
- High and low pressure gauges
- Smoke detector
- Application for low outdoor temperature
- Spring antivibration mounts (accessory separately supplied)
- Roof curb (separately supplied accessories)
- Clivet Master System (accessory separately supplied)
- Sandwich panels of the handling zone in M0 fire reaction class
- Set up for shipping via container
- Roof curb

All exchangers can be covered with aluminium - fin guard - copper/copper.

Test

Unit manufactured to ISO 9001 standard and commissioned upon production completion.

Configuration with double fan section for recirculation, fresh air, exhaust, thermodynamic recovery (CCK)

Technical features as the configuration with single fan section for full recirculation (CAK) and single fan section for recirculation and fresh air (CBK) and moreover:

Modulating motorized outdoor air damper for renewal and e FREE-COOLING

Exhaust fan

Plug fans without scroll with reverse blades driven by electronically-controlled "brushless" DC motors with direct coupling. No drive sizing is required.

Thermodynamic recovery on the exhaust air

The energy content of the exhaust air is recovered by the external exchanger, through a dedicated fan section. The favourable air temperature on the source side increases unit capacity.

Configuration with double fan section for recirculation, fresh air, exhaust, THOR thermodynamic recovery (CCKP)

Technical features like the configuration with recirculation, renewal, exhaust air and thermodynamic recovery (CCK) and also:

Exchanger for thermodynamic recovery - THOR

The energy content of the exhaust air is recovered by a dedicated exchanger, as integral part of the refrigeration circuit. It is a direct expansion finned coil exchanger made with copper pipes placed on staggered rows mechanically expanded to better adhere to the fin collar. The fins are made from aluminium with a corrugated surface and adequately distanced to ensure the maximum heat exchange efficiency.

The broad CLIVETPack CSRN-XHE2 series

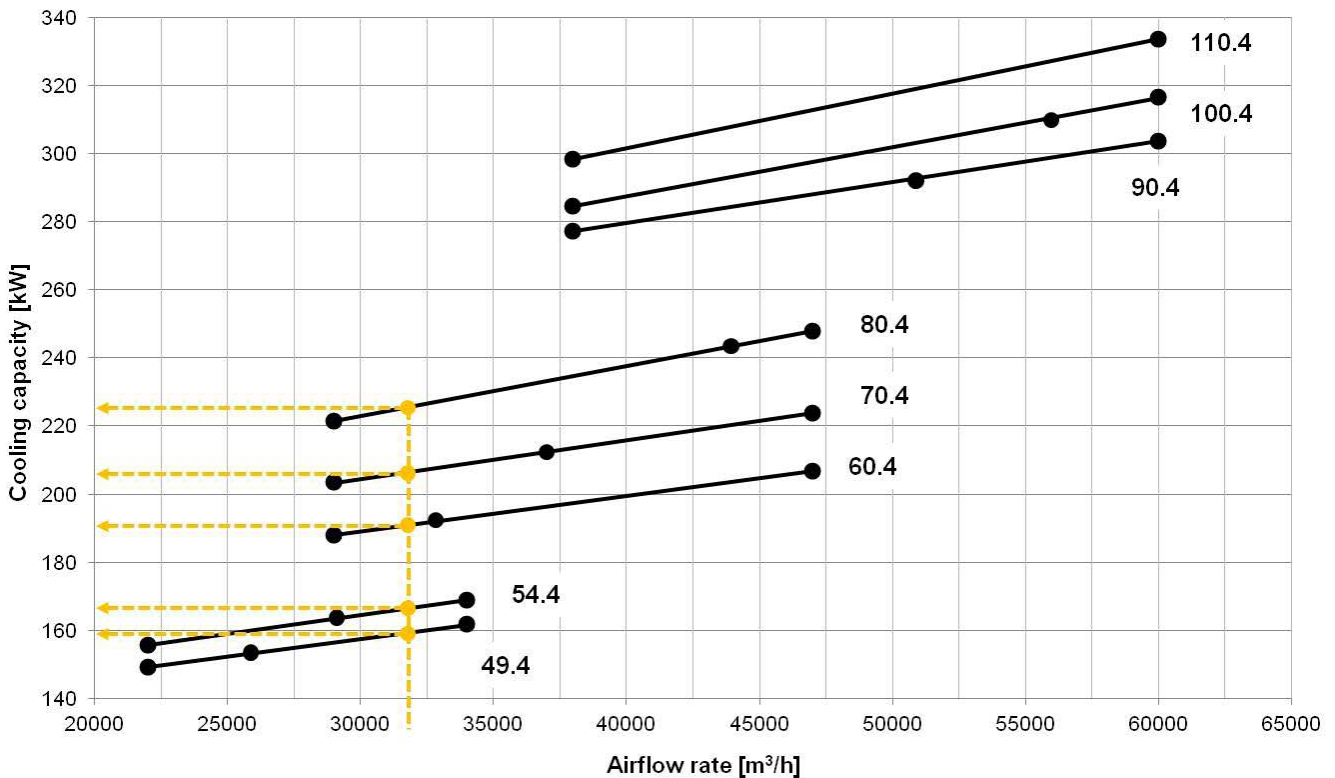

Different heating-cooling handling is available depending on the air flow, based on the selected size.

All recirculation performance.

STANDARD AIRFLOW

Size				49.4	54.4	60.4	70.4	80.4	90.4	100.4	110.4
Cooling											
Cooling capacity	CAK	1	kW	154.6	164.6	195.0	213.0	245.2	297.3	311.9	333.6
Sensible capacity		1	kW	116.3	124.3	143.6	164.2	184.2	222.8	234.7	246.0
Compressor power input		1	kW	40.9	45.0	49.9	58.4	64.7	75.7	84.1	94.7
EER		1		3.78	3.66	3.91	3.64	3.79	3.93	3.71	3.52
SEER		11		3.88	3.46	3.84	3.71	3.67	3.95	3.55	3.40
Cooling capacity	CBK	2	kW	161.2	171.3	202.9	223.2	257.6	310.1	328.2	346.8
Sensible capacity		2	kW	119.4	128.6	148.7	167.3	187.8	229.3	238.0	253.8
Compressor power input		2	kW	41.5	45.5	50.6	59.5	65.5	76.8	85.7	96.2
EER		2		3.88	3.76	4.01	3.75	3.93	4.04	3.83	3.60
Cooling capacity	CCK	3	kW	164.2	175.1	206.0	227.1	262.5	314.7	333.2	353.0
Sensible capacity		3	kW	121.2	130.7	150.2	169.0	190.3	231.9	240.8	256.9
Compressor power input		3	kW	40.2	43.9	49.4	58.1	63.6	74.9	83.5	93.6
EER		3		4.08	3.99	4.17	3.91	4.13	4.20	3.99	3.77
Cooling capacity	CCKP	3	kW	174.9	185.9	220.2	242.1	279.5	336.4	356.0	376.2
Sensible capacity		3	kW	128.7	138.6	160.2	180.3	202.4	247.1	256.5	273.6
Compressor power input		3	kW	41.1	45.1	50.1	59.0	65.1	76.4	85.1	95.3
EER		3		4.26	4.12	4.40	4.10	4.29	4.40	4.18	3.95
Heating											
Heating capacity	CAK	1	kW	161.1	171.9	198.9	220.6	255.1	302.1	323.1	350.0
Compressor power input		1	kW	34.4	36.9	42.5	48.6	55.4	64.8	69.9	79.2
COP		1		4.68	4.66	4.68	4.54	4.60	4.66	4.62	4.42
SCOP		11		3.31	3.12	3.10	3.06	3.05	3.04	3.00	3.10
Heating capacity	CBK	2	kW	163.5	174.3	202.5	223.7	258.9	306.2	327.4	354.5
Compressor power input		2	kW	31.7	33.8	39.0	44.8	51.3	60.1	65.1	72.6
COP		2		5.16	5.16	5.19	4.99	5.05	5.09	5.03	4.88
Heating capacity	CCK	3	kW	167.8	179.3	206.4	228.7	265.4	311.7	333.4	361.9
Compressor power input		3	kW	32.1	34.2	39.4	45.4	51.9	61.1	65.8	73.6
COP		3		5.23	5.24	5.24	5.04	5.11	5.10	5.07	4.92
Heating capacity	CCKP	3	kW	176.3	186.6	218.3	241.2	279.1	330.1	353.0	382.2
Compressor power input		3	kW	32.8	36.5	40.3	46.3	53.0	62.1	67.3	75.0
COP		3		5.38	5.11	5.42	5.21	5.27	5.32	5.25	5.10
THOR recovery efficiency		4	%	91	88	94	93	87	84	84	85
Compressor											
Type of compressors		5		Scroll	Scroll	Scroll	Scroll	Scroll	Scroll	Scroll	Scroll
No. of compressors			Nr	4	4	4	4	4	4	4	4
Std Capacity control steps			Nr	6	6	4	6	6	6	6	6
Refrigerant charge (C1)		6	kg	31	38	38	34	50	64	67	67
Refrigerant charge (C2)		6	kg	38	38	38	34	50	64	67	67
Refrigeration circuits			Nr	2	2	2	2	2	2	2	2
Air Handling Section Fans (Supply)											
Type of supply fan		7		RAD	RAD	RAD	RAD	RAD	RAD	RAD	RAD
No. of supply fans			Nr	3	3	4	4	4	6	6	6
Fan diameter			mm	560	560	560	560	560	560	560	560
Supply airflow			m³/h	26000	29000	33000	37000	44000	51000	56000	60000
Supply airflow			l/s	7222	8056	9167	10278	12222	14167	15556	16667
Installed unit power			kW	2.90	2.90	2.90	2.90	2.90	2.90	2.90	2.90
Max. static pressure supply fan		8	Pa	630	540	660	570	360	620	540	460
High static pressure air handling section fans (OPTIONAL)											
Type of supply fan				RAD	RAD	RAD	RAD	RAD	RAD	RAD	RAD
No. of supply fans			Nr	3	3	4	4	4	6	6	6
Fan diameter			mm	500	500	500	500	500	500	500	500
Supply airflow			m³/h	26000	29000	33000	37000	44000	51000	56000	60000
Supply airflow			l/s	7222	8056	9167	10278	12222	14167	15556	16667
Installed unit power			kW	5.5	5.5	5.5	5.5	5.5	5.5	5.5	5.5
Max. static pressure supply fan			Pa	1140	1080	1140	1140	900	1140	1140	1020

Size			49.4	54.4	60.4	70.4	80.4	90.4	100.4	110.4
Fans (Exhaust) (only CCK, CCKP-THOR configuration)										
Type of fans		7	RAD	RAD	RAD	RAD	RAD	RAD	RAD	RAD
No. of fans		9	Nr	2	2	2	2	2	2	2
Installed unit power		9	kW	2.60	2.60	2.70	2.70	2.70	2.70	2.70
External Section Fans										
Type of fans		10	AX	AX	AX	AX	AX	AX	AX	AX
No. of fans			Nr	2	2	4	4	4	6	6
Standard airflow			l/s	12500	12500	23333	23333	23333	35000	35000
Single power input			kW	1.5	1.5	1.5	1.5	1.5	1.5	1.5
Connections										
Condensate drain			mm	30	30	30	30	30	30	30
Power supply										
Standard power supply			V	400/3/50	400/3/50	400/3/50	400/3/50	400/3/50	400/3/50	400/3/50

The Product is compliant with the Erp (Energy Related Products) European Directive. It includes the Commission delegated Regulation (EU) No 2016/2281, also known as Ecodesign Lot21.

Contains fluorinated greenhouse gases (GWP 2087,5)

Performances in cooling: Indoor air temp. 27°C/19°C W.B. Entering external exchanger air temperature 35°C D.B./24°C W.B. EER referred only to compressors

Performance in Heating: Indoor air temp. 20°C D.B./12°C W.B. entering air to the external exchanger 7°C/6°C W.B. COP referred only to compressors

1. Performance refers to operation at full re-circulation
2. Performance with 30% of outdoor air
3. Performance with 30% of outdoor air including the energy recovery on the exhaust air
4. Energy recovery efficiency determined on the exhaust air. Indoor temperature 20°C D.B./12°C W.B., outdoor temperature 7°C D.B./6°C W.B.

5. SCROLL = scroll compressor
6. Indicative values for standard units with possible +/-10% variation. The actual data are indicated on the label of the unit
7. RAD = radial fan electronically controlled
8. Net outside static pressure to win the outlet and intake onboard pressure drops
9. Configuration with double fan section for recirculation, fresh air, exhaust, thermodynamic recovery (CCK) and configuration with double fan section with fresh air and THOR thermodynamic recovery (CCKP)
10. AX = axial fan
11. SEER and SCOP according to EN 14825:2016 as indicated in the UE Regulations 2281 (ErP 2018).

Sound levels

Size	Sound Power [dB]								Sound pressure level	Sound power level
	Octave band (Hz)									
	63	125	250	500	1000	2000	4000	8000	[dB(A)]	[dB(A)]
49.4	99	95	98	88	84	75	70	67	72	92
54.4	101	95	95	90	87	78	74	72	72	92
60.4	105	95	95	91	86	80	75	73	72	93
70.4	106	96	95	92	88	83	77	75	73	94
80.4	106	97	96	93	89	82	77	75	74	95
90.4	107	101	100	94	92	85	79	78	76	97
100.4	108	102	101	95	93	86	80	79	77	98
110.4	109	103	102	96	94	87	81	80	78	99

The sound levels are referred to unit operating at full load in nominal conditions. The sound pressure level is referred at a distance of 1 m. from the ducted unit surface operating in free field conditions. External static pressure 50 Pa. (standard UNI EN ISO 9614-2)
Please note that when the unit is installed in conditions different from nominal test conditions (e.g. near walls or obstacles in general), the sound levels may undergo substantial variations.

Electrical input of optional components

To obtain the electrical input of the unit including accessories, add the standard data in Electrical Data table to those for the selected accessories.

SIZES			49.4	54.4	60.4	70.4	80.4	90.4	100.4	110.4
F.L.A. Absorbed current										
F.L.A. EH20 - 24 kW electric elements		A	34.6	34.6	34.6	34.6	34.6	34.6	34.6	34.6
F.L.A. EH24 - 36 kW Heating elements		A	52.0	52.0	52.0	52.0	52.0	52.0	52.0	52.0
F.L.A. EH28 - 48 kW electric elements		A	69.4	69.4	69.4	69.4	69.4	69.4	69.4	69.4
F.L.A. HSE8 - Immersed electrodes steam humidifier of 8 kg/h		A	8.7	8.7	8.7	8.7	8.7	8.7	8.7	8.7
F.L.A. HSE9 - Immersed electrodes steam humidifier of 15 kg/h		A	16.2	16.2	16.2	16.2	16.2	16.2	16.2	16.2
F.L.A. LTEMP1 - Application for low outdoor temperature		A	1.0	1.0	1.0	1.0	1.0	1.0	1.0	1.0
F.L.A. VENH - High static pressure fans	1	A	11.9	11.9	15.9	15.9	15.9	23.8	23.8	23.8
F.L.I. Power input										
F.L.I. EH20 - Electric elements of 24 kW		kW	24.0	24.0	24.0	24.0	24.0	24.0	24.0	24.0
F.L.I. EH24 - 36 kW heating elements		kW	36.0	36.0	36.0	36.0	36.0	36.0	36.0	36.0
F.L.I. EH28 - 48 kW electric elements		kW	48.0	48.0	48.0	48.0	48.0	48.0	48.0	48.0
F.L.I. HSE8 - Immersed electrodes steam humidifier of 8 kg/h		kW	6.0	6.0	6.0	6.0	6.0	6.0	6.0	6.0
F.L.I. HSE9 - Immersed electrodes steam humidifier of 15 kg/h		kW	11.3	11.3	11.3	11.3	11.3	11.3	11.3	11.3
F.L.I. LTEMP1 - Application for low outdoor temperature		kW	0.3	0.3	0.3	0.3	0.3	0.3	0.3	0.3
F.L.I. VENH - High static pressure fans	1	kW	7.8	7.8	10.4	10.4	10.4	15.6	15.6	15.6

1. The absorption value that needs to be added on takes into account the difference between the optional high head fans and the standard fans.

Electrical data

Configuration: with direct ductable return (CAK) and outdoor air recirculation (CBK)

Size		49.4	54.4	60.4	70.4	80.4	90.4	100.4	110.4
F.L.A. - Full load current at max admissible conditions									
F.L.A. - Compressor 1	A	15,4	23,0	30,9	30,9	30,9	30,9	36,5	44,6
F.L.A. - Compressor 2	A	30,9	30,9	30,9	36,5	44,6	59,3	59,3	59,3
F.L.A. - Compressor 3	A	23,0	23,0	30,9	30,9	30,9	30,9	36,5	44,6
F.L.A. - Compressor 4	A	30,9	30,9	30,9	36,5	44,6	59,3	59,3	59,3
F.L.A. - Single External Fan	A	3,9	3,9	3,9	3,9	3,9	3,9	3,9	3,9
F.L.A. - Single supply fan	A	4,4	4,4	4,4	4,4	4,4	4,4	4,4	4,4
F.L.A. - Total	1 A	122,1	129,7	157,7	168,9	185,1	231,2	242,3	258,6
L.R.A. - Locked rotor amperes									
L.R.A. - Compressor 1	A	95,0	118,0	174,0	174,0	174,0	174,0	225,0	272,0
L.R.A. - Compressor 2	A	174,0	174,0	174,0	225,0	272,0	310,0	310,0	310,0
L.R.A. - Compressor 3	A	118,0	118,0	174,0	174,0	174,0	174,0	225,0	272,0
L.R.A. - Compressor 4	A	174,0	174,0	174,0	225,0	272,0	310,0	310,0	310,0
F.L.I. - Full load power input at max admissible conditions									
F.L.I. - Compressor 1	kW	9,1	13,1	17,0	17,0	17,0	17,0	22,6	27,6
F.L.I. - Compressor 2	kW	17,0	17,0	17,0	22,6	27,6	36,1	36,1	36,1
F.L.I. - Compressor 3	kW	13,1	13,1	17,0	17,0	17,0	17,0	22,6	27,6
F.L.I. - Compressor 4	kW	17,0	17,0	17,0	22,6	27,6	36,1	36,1	36,1
F.L.I. - Single External Fan	kW	1,9	1,9	1,9	1,9	1,9	1,9	1,9	1,9
F.L.I. - Single supply fan	kW	2,9	2,9	2,9	2,9	2,9	2,9	2,9	2,9
F.L.I. - Total	2 kW	69,1	73,1	87,7	99,0	109,0	135,6	146,9	156,9
M.I.C. Maximum inrush current									
M.I.C. - Value	A	265,2	272,8	300,8	357,4	412,5	481,9	493,0	509,3

Configuration: with recirculation, exhaust and fresh air (CCK) and mixing chamber with recovery exchanger (CCKP)

Size		49.4	54.4	60.4	70.4	80.4	90.4	100.4	110.4
F.L.A. - Full load current at max admissible conditions									
F.L.A. - Compressor 1	A	15,4	23,0	30,9	30,9	30,9	30,9	36,5	44,6
F.L.A. - Compressor 2	A	30,9	30,9	30,9	36,5	44,6	59,3	59,3	59,3
F.L.A. - Compressor 3	A	23,0	23,0	30,9	30,9	30,9	30,9	36,5	44,6
F.L.A. - Compressor 4	A	30,9	30,9	30,9	36,5	44,6	59,3	59,3	59,3
F.L.A. - Single External Fan	A	3,9	3,9	3,9	3,9	3,9	3,9	3,9	3,9
F.L.A. - Single supply fan	A	4,4	4,4	4,4	4,4	4,4	4,4	4,4	4,4
F.L.A. - Single exhaust air fan	A	4,0	4,0	4,3	4,3	4,3	4,3	4,3	4,3
F.L.A. - Total	1 A	130,0	137,6	166,3	177,5	193,7	239,8	250,9	267,2
L.R.A. - Locked rotor amperes									
L.R.A. - Compressor 1	A	95,0	118,0	174,0	174,0	174,0	174,0	225,0	272,0
L.R.A. - Compressor 2	A	174,0	174,0	174,0	225,0	272,0	310,0	310,0	310,0
L.R.A. - Compressor 3	A	118,0	118,0	174,0	174,0	174,0	174,0	225,0	272,0
L.R.A. - Compressor 4	A	174,0	174,0	174,0	225,0	272,0	310,0	310,0	310,0
F.L.I. - Full load power input at max admissible conditions									
F.L.I. - Compressor 1	kW	9,1	13,1	17,0	17,0	17,0	17,0	22,6	27,6
F.L.I. - Compressor 2	kW	17,0	17,0	17,0	22,6	27,6	36,1	36,1	36,1
F.L.I. - Compressor 3	kW	13,1	13,1	17,0	17,0	17,0	17,0	22,6	27,6
F.L.I. - Compressor 4	kW	17,0	17,0	17,0	22,6	27,6	36,1	36,1	36,1
F.L.I. - Single External Fan	kW	1,9	1,9	1,9	1,9	1,9	1,9	1,9	1,9
F.L.I. - Single supply fan	kW	2,9	2,9	2,9	2,9	2,9	2,9	2,9	2,9
F.L.I. - Single exhaust air fan	kW	2,6	2,6	2,8	2,8	2,8	2,8	2,8	2,8
F.L.I. - Total	2 kW	74,3	78,2	93,2	104,5	114,5	141,1	152,4	162,4
M.I.C. Maximum inrush current									
M.I.C. - Value	A	273,1	280,7	309,4	366,0	421,1	490,5	501,6	517,9

Data refer to standard units. power supply: 400/3/50 Hz +/-10% Voltage unbalance: max 2%

Values not including accessories

1. Values not including the accessories. To obtain the value of F.L.A. including accessories, add to the total F.L.A. value that of any accessories (see electrical data of accessories)

2. Values not including the accessories. To obtain the value of F.L.I. including accessories, add to the total F.L.I. value that of any accessories (see electrical data of accessories)

Pressure drops of optional components

The value of static pressure available on the supply and return duct is obtained by subtracting from the available net maximum pressure (see general table of technical data) the pressure drops of any accessories.

SIZES			49.4	54.4	60.4	70.4	80.4	90.4	100.4	110.4
CHW2 - Two-row hot water coil		Pa	35	43	31	39	52	46	54	61
CPHG - Hot gas re-heating coil		Pa	18	20	19	21	25	23	26	28
CHWER - Energy recovery from food refrigeration		Pa	65	79	59	73	100	90	102	116
HWS - Steam humidifier with disposable water		Pa	23	25	24	26	30	28	31	33
GC - Heating module		Pa	90	100	80	90	100	80	90	100
F7 - F7 high efficiency air filter	1	Pa	130	138	128	137	152	151	162	172
FES - Electronic filters		Pa	61	70	56	65	82	81	92	101

The values shown are to be considered approximate for units operating power in normal use with standard air flow rate.

1. Pressure drops with filters with average dirtiness

Operating range (Cooling)

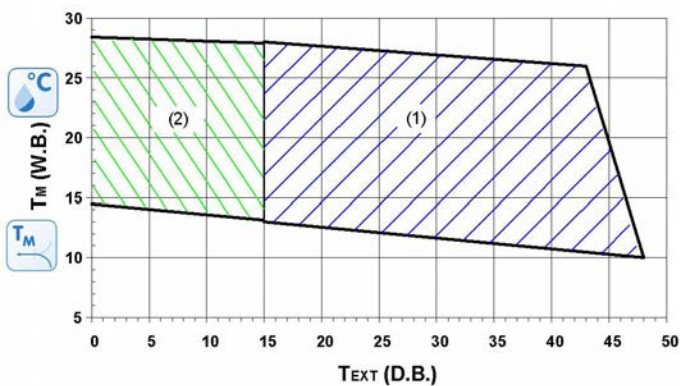

The limits are meant as an indication and they have been calculated by considering:

- general and non specific sizes,
- standard airflow,
- non-critical positioning of the unit and correct operating and maintenance of the unit,
- operating at full load.

To verify the operation field of the operating units with percentages of outdoor air, always calculate the T_m mixing temperature at the internal heat exchanger input.

T_m = internal exchanger entering air temperature temperature measured with wet bulb (W.B.=WET BULB)

Text = inlet air temperature in the external exchanger dry bulb measured temperature (D.B.=DRY BULB)

1. Standard operating range

2. Operation range of the unit in FREE-COOLING mode or with automatic distribution of the outdoor ventilation

WET BULB TEMPERATURE - EXAMPLE



Operating range (Heating)

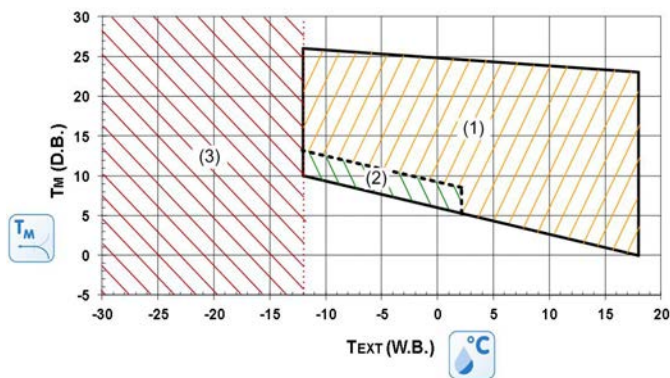

The limits are meant as an indication and they have been calculated by considering:

- general and non specific sizes,
- standard airflow,
- non-critical positioning of the unit and correct operating and maintenance of the unit,
- operating at full load

To verify the operation field of the operating units with percentages of outdoor air, always calculate the T_m mixing temperature at the internal heat exchanger input.

T_m = internal exchanger entering air temperature dry bulb measured temperature (D.B.=DRY BULB)

Text = inlet air temperature in the external exchanger temperature measured with wet bulb (W.B.=WET BULB)

1. Operation range at full load

2. Range in which the unit operation is allowed only for a limited period (max 1 hour)

3. Operation range of the unit equipped with "application for low outdoor temperature" and "hot water coil" or "gas heating module" options. The heat pump circuit is not active.

In extended operating mode, in heat pump operation with an outdoor air temperature of less than 6°C, the unit performs defrosts by reversing the cycle, activating one circuit at a time and maintaining the ventilation active to eliminate the ice that forms on the surfaces of the outside exchanger. In the event of negative temperatures, the water resulting from the defrosts must be drained so as to avoid the accumulation of ice near the base of the unit. Make sure that this does not constitute a danger for people or things.

With an outdoor air temperature between -10°C and -30°C install the following options: hot water coil or gas heating module and outdoor air low temperature configuration.

Accessories

EH - Electric elements

This option is suggested for cold climates, allows the integration of heating capacity from the heat pump. The electrical heaters are placed before the treatment coil and perform the air preheating function, extending the operating range of the unit and helping quickly to reach the comfort in the room. Ideal for climate areas in applications with low outside temperature where it is required to active the heaters only for short time in the year. In these cases the resulting system simplification (no water supply) compensates the energy costs. The fins are made of aluminum, of suitable dimension to ensure high efficiency and maintain low power density on the surfaces to limit overheating. The low temperature of the heating elements increases the lifespan and limits the effect of air ionization.



The electrical heating elements are managed by the controller with two power steps.

Matching of the electric elements

Size	49.4	54.4	60.4	70.4	80.4	90.4	100.4	110.4
24 kW	√	√	√	√	√	√	√	√
36 kW	√	√	√	√	√	√	√	√
48 kW	√	√	√	√	√	√	√	√

This option involves variation of the main electrical data of the unit.

'Electric elements', '2-row hot water coil', 'Combustion heating module' and 'Energy recovery from food refrigeration' cannot be assembled simultaneously.

Operation field extension with electric heaters

The minimum operating temperature of the heat pump with electric heater change and depends on the series and the power of the electric heater. The minimum temperature is easily to reckon subtrahend the DT value (table following below) to the entering internal exchanger air temperature T_m (D.M.) for standard unit, at the desired conditions.

SIZES	Airflow [m3/h]	POWER ELECTRIC HEATERS / DELTA T [°C]		
		24kW	36 kW	48kW
49.4	26000	2.7	4.1	5.5
54.4	29000	2.5	3.7	4.9
60.4	33000	2.2	3.2	4.3
70.4	37000	1.9	2.9	3.8
80.4	44000	1.6	2.4	3.2
90.4	52000	1.4	2.1	2.7
100.4	56000	1.3	1.9	2.5
110.4	60000	1.2	1.8	2.4

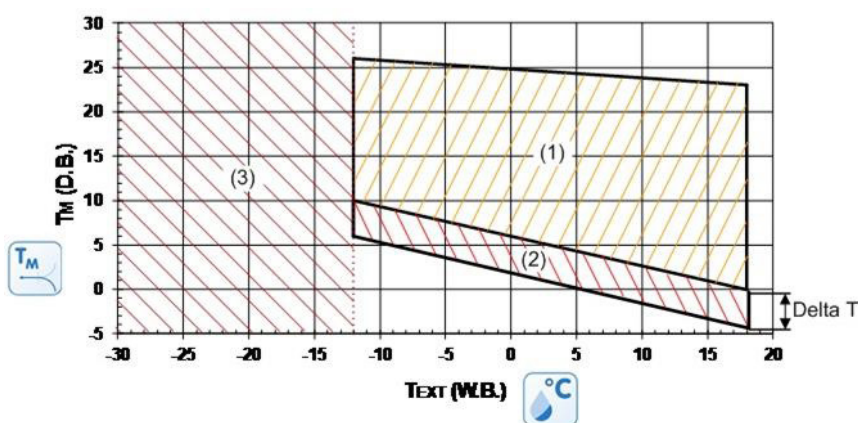

The limits are meant as an indication and they have been calculated by considering:

- general and non specific sizes,
- standard airflow,
- non-critical positioning of the unit and correct operating and maintenance of the unit,
- operating at full load

To verify the operation field of the operating units with percentages of outdoor air, always calculate the T_m mixing temperature at the internal heat exchanger input.

T_m = internal exchanger entering air temperature dry bulb measured temperature (D.B.=DRY BULB)

Text = inlet air temperature in the external exchanger temperature measured with wet bulb (W.B.=WET BULB)

1. Operation range at full load
2. Operation field of the unit equipped with electric elements
3. Operation range of the unit equipped with "application for low outdoor temperature" and "hot water coil" or "gas heating module" options. The heat pump circuit is not active.

With an outdoor air temperature between -10°C and -30°C install the following options: hot water coil or gas heating module and outdoor air low temperature configuration.

GD - 2-stage gas heating module

Option consisting of a combustion chamber and burner with 2-stage control. It is available in various capacities and heats the environment served. The module can be chosen to integrate the heat pump or as an alternative to it. In this case, its heating capacity must be at least equal to the capacity envisioned in the project.

The burner with low polluting emissions (NO_x lower than 50mg/kWh) in accordance with Class 5 of European standard EN 676.

The unit logic controls the module and communicates with the microprocessor control integrated in the burner.

The module is supplied ready for use and during installation it has to be connected to the unit.

The gas module presence needs the horizontal supply.

The heating module with burner includes:

- hot air generator with two capacity step control powered with natural gas;
- kit for transformation of power with liquefied petroleum gas (LPG);
- kit of steel chimney for exhaust fumes;
- all the control and safety devices.

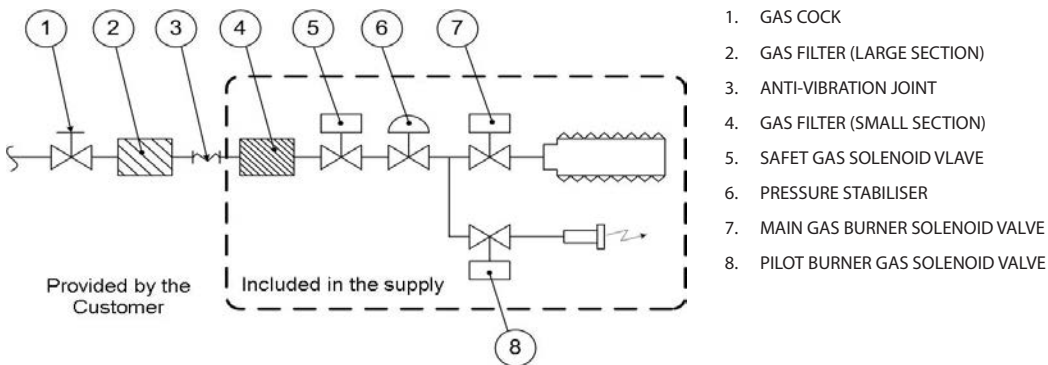

Gas use features

Size		74kW		100kW		147kW		200kW		300kW	
Description		min	max	min	max	min	max	min	max	min	max
Nominal heating capacity	kW	60.0	73.5	81.8	100.0	60.0	147.0	81.8	200.0	81.8	300.0
Efficiency Hi (P.C.I.)	%	93.7	91.8	93.9	92.3	93.7	91.8	93.9	92.3	93.9	92.3
Efficiency Hu (P.C.S.)	%	84.1	82.6	84.5	83.1	84.3	82.6	84.5	83.1	84.5	83.1
Available head for the chimney	Pa	140		140		140		120		120	
Gas connection diameter	GAS	UNI ISO 7/1-3/4" M		UNI ISO 7/1-1" M		UNI ISO 7/1-1" M		UNI ISO 7/1-1 1/2" M		UNI ISO 7/1-1 1/2" M	
Fume chimney diameter	mm	80		80		2 x 80		2 x 80		3 x 80	

Matching of the gas heating module

Size	49.4	54.4	60.4	70.4	80.4	90.4	100.4	110.4
GD14X (74 kW)	√	√	X	X	X	X	X	X
GD15X (100 kW)	√	√	√	√	√	X	X	X
GD16X (147 kW)	√	√	√	√	√	√	√	√
GD17X (200 kW)	X	X	√	√	√	√	√	√
GD18X (300 kW)	X	X	X	X	X	√	√	√

This option reduces the available static pressure (supply air side).



The component requires gas supply (gas connections to be made by the Customer). The location of the unit and the fume drain mode must comply with laws and standards in force in the Country of use.



The Customer is responsible for mounting the chimney kit during installation. Based on the specific installation requirements, the length of the chimney can be increased with suitable joints and fittings (not supplied by Clivet).



'Electric elements', '2-row hot water coil', 'Combustion heating module' and 'Energy recovery from food refrigeration' cannot be assembled simultaneously.

GC - Condensing gas heating module and modulating control

Option consisting of a combustion chamber and condensation burner with modulating control. It is available in various capacities and heats the environment served. The module can be chosen to integrate the heat pump or as an alternative to it. In this case, its heating capacity must be at least equal to the capacity envisioned in the project.

Thanks to the condensation technology with pre-mix and extremely efficient modulation (up to 105% depending on the lower heat value), consumption is very contained and considerably reduced during operation at partial load. The burner with low polluting emissions (NOx lower than 50mg/kWh) in accordance with Class 5 of European standard EN 676.

The module is supplied ready for use and during installation it has to be connected to the unit.

The gas module presence needs the horizontal supply.

The heating module includes:

- hot air generator with condensation and integrated modulating adjustment, powered with natural gas;
- kit for transformation of power with liquefied petroleum gas (LPG);
- kit of steel chimney for exhaust fumes;
- all the control and safety devices.



Gas connection diagram

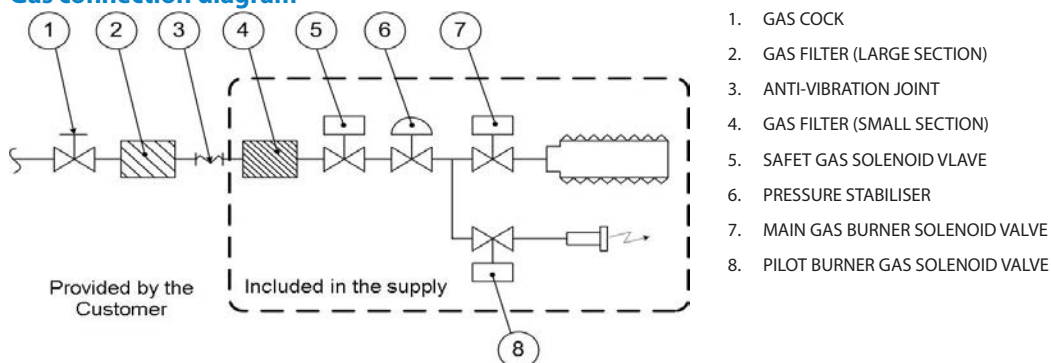

1. GAS COCK
2. GAS FILTER (LARGE SECTION)
3. ANTI-VIBRATION JOINT
4. GAS FILTER (SMALL SECTION)
5. SAFET GAS SOLENOID VALVE
6. PRESSURE STABILISER
7. MAIN GAS BURNER SOLENOID VALVE
8. PILOT BURNER GAS SOLENOID VALVE

Gas use features

Size		65kW		82kW		100kW		130kW		164kW		200kW		300kW	
		min	max	min	max	min	max	min	max	min	max	min	max	min	max
Description															
Nominal heating capacity	kW	12,4	65	16,4	82	21	100	12,4	130	16,4	164	21	200	21	300
Efficiency Hi (P.C.I.)	%	108,1	96,8	108,4	97,6	22,8	97,2	108,1	96,8	108,4	97,6	108,6	97,2	108,6	97,2
Efficiency Hu (P.C.S.)	%	97,4	87,2	97,6	87,9	97,8	87,5	97,4	87,2	108,4	97,6	108,6	97,2	108,6	97,2
Max condensation produced	l/h	2,1		3,3		2,7		4,2		6,6		5,4		8,1	
Carbon monoxide CO (0% of O2)	ppm	<5		<5		<5		<5		<5		<5		<5	
Nitrogen oxides - NOx (0% of O2)		40 mg / kWh 23 ppm		34 mg / kWh 19 ppm		45 mg / kWh 26 ppm		40 mg / kWh 23 ppm		34 mg / kWh 19 ppm		45 mg / kWh 26 ppm		45 mg / kWh 26 ppm	
Available flue pressure	Pa	120		120		120		120		120		120		120	
Gas connection diameter	GAS	UNI ISO 7/1-3/4" M		UNI ISO 7/1-1" M		UNI ISO 7/1-1" M		UNI ISO 7/1-1" M		UNI ISO 7/1-1 1/2" M		UNI ISO 7/1-1 1/2" M		UNI ISO 7/1-1 1/2" M	
Exhaust pipe diameter	mm	80		80		80		2 x 80		2 x 80		2 x 80		3 x 80	

Matching of the condensing gas heating module

Size	49.4	54.4	60.4	70.4	80.4	90.4	100.4	110.4
GC09X (65kW)	√	√	X	X	X	X	X	X
GC10X (82kW)	√	√	√	√	√	X	X	X
GC11X (100kW)	√	√	√	√	√	X	X	X
GC12X (130kW)	√	√	X	X	X	√	√	√
GC13X (164kW)	X	X	√	√	√	√	√	√
GC06X (200kW)	X	X	√	√	√	√	√	√
GC07X (300kW)	X	X	X	X	X	√	√	√

This option reduces the available static pressure (supply air side).

The component requires gas supply (gas connections to be made by the Customer). The location of the unit and the fume drain mode must comply with laws and standards in force in the Country of use.

The assembly of the chimney kit must be performed on site by the Customer. According to specific requirements of installation, the chimney length can be increased by means of appropriate joints and fittings (not supplied by Clivet).

'Electric elements', '2-row hot water coil', 'Combustion heating module' and 'Energy recovery from food refrigeration' cannot be assembled simultaneously.

CHW2 - Two-row hot water coil

Option indicated for very cold climates, as it allows to heat up the area served. The exchanger comes with a thermostat for the antifreeze function, which is always active even when the unit is in stand-by, as long as it is operated electrically. If required, force the opening of the valve to the maximum value allowed to allow the air to pass through the exchanger and prevent frost from forming.

The hot water coil allows the integration of the heat pump capacity, as being placed before the treating coil, it pre-heats the air, extending the operation limits of the unit. If the water coil operates as integration to the heat pump, the control logic reduces the potential at a pre-determined limit value, which prevents to make the compressors work at too high condensation temperatures. On the other hand, if the water coil is used as main resource (i.e. availability of the compressors) the potential supplied will be the highest.

In the event laws or local standards encourage the use of the district heating, and so the use of hot water coil heating with the obligation to recover the energy contained inside the exhaust air flow, a turning point can be set, that is an outside air temperature, below which the unit uses the water coil as main resource and operates also as thermodynamic recuperator at very high efficiency, using the nominal capacity of the heat pump circuit only partially.

Hot water coil pressure drops: AIR side

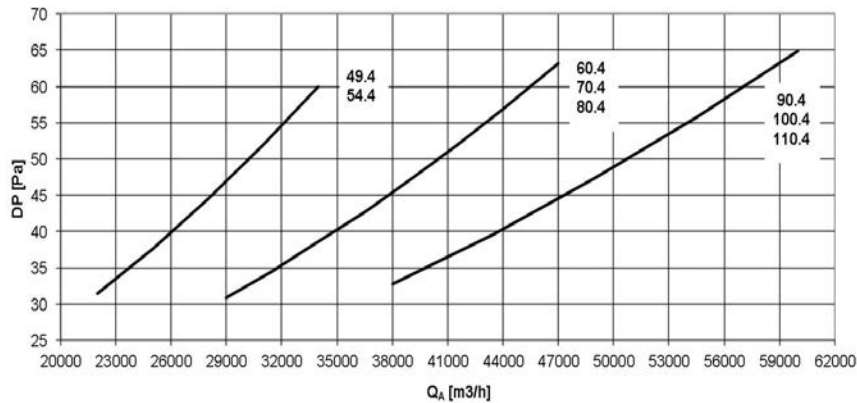

The air side pressure drops are relative to the medium air temperature of 20°C and are to be added to the pressure drops due to ducts, terminal devices and any other component that causes a drop in working discharge head.

QA [m3/h] = airflow
DP[Pa] = pressure drops

Hot water coil pressure drops: WATER side

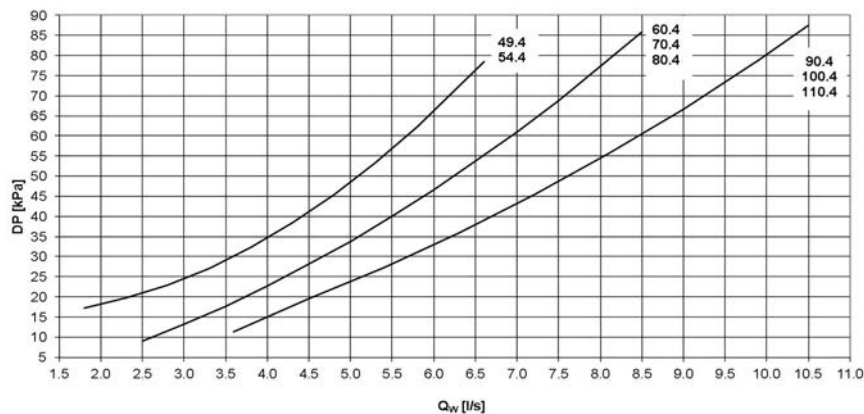

Pressure drops on the water side are calculated considering an average water temperature of 65°C.

Qw [l/s] = water flow-rate
DP[kPa] = pressure drops

$$Q_w [l/s] = P / (4.186 \times DT)$$

P = Water coil heating capacity in KW
DT = Temperature difference between inlet / outlet water

This option reduces the available static pressure (supply air side).



The component requires connection to the hot water plumbing system (to be provided for by the Client).



'Electric elements', '2-row hot water coil', 'Combustion heating module' and 'Energy recovery from food refrigeration' cannot be assembled simultaneously.

Performances of hot water coil (two-row)

SIZE		Ti/To (°C)												
		60 / 40	70 / 55	70 / 60	80 / 65	60 / 40	70 / 55	70 / 60	80 / 65	60 / 40	70 / 55	70 / 60	80 / 65	
		kWt	kWt	kWt	kWt	kWt	kWt	kWt	kWt	kWt	kWt	kWt	kWt	
49.4 54.4	Qo (m ³ / h)	22000				28000				34000				
	Qo (l / s)	6111				7777				9444				
	TM (°C)	5	182,0	240,1	253,2	283,9	212,2	281,4	297,3	333,2	239,7	318,5	337,0	377,5
		10	159,3	217,5	230,4	261,1	185,9	254,9	270,7	306,3	209,7	288,6	306,9	347,0
		14	141,4	199,5	212,5	243,0	165,0	233,9	249,6	285,1	186,0	264,7	283,0	323,0
		16	132,5	190,5	203,5	234,0	154,5	223,4	239,1	274,5	174,2	252,9	271,1	311,0
		18	123,5	181,7	194,6	225,0	144,0	213,0	228,7	264,0	162,3	241,1	259,3	299,2
20	114,6	172,9	185,7	216,1	133,5	202,6	218,3	253,6	150,4	229,3	247,5	287,3		
60.4 70.4 80.4	Qo (m ³ / h)	29000				38000				47000				
	Qo (l / s)	8055				10555				13055				
	TM (°C)	5	235,7	312,8	330,4	370,3	280,1	373,4	395,4	442,5	319,3	427,2	453,1	506,7
		10	206,3	283,0	300,7	340,4	245,1	338,0	359,9	406,9	279,2	386,8	412,5	465,9
		14	182,8	259,7	277,0	316,7	217,0	310,0	331,7	378,6	247,3	354,7	380,3	433,6
		16	171,1	247,8	265,3	304,9	203,1	295,9	317,5	364,5	231,2	338,7	364,0	417,5
		18	159,5	236,4	253,8	293,2	189,1	282,1	303,7	350,5	215,2	322,8	348,1	401,4
20	147,9	224,8	242,2	281,4	175,1	268,3	289,9	336,6	199,2	306,7	332,3	385,5		
90.4 100.4 110.4	Qo (m ³ / h)	38000				49000				60000				
	Qo (l / s)	10555				13611				16666				
	TM (°C)	5	313,4	412,6	434,6	487,8	369,1	487,4	514,4	576,9	418,3	554,3	585,8	656,5
		10	275,1	373,9	395,6	448,6	323,3	441,7	468,5	530,6	366,8	502,4	533,6	603,9
		14	244,5	343,2	364,8	417,3	287,0	405,5	432,1	493,6	325,3	461,1	492,2	561,8
		16	229,0	327,9	349,6	402,0	269,1	387,4	414,0	475,4	304,8	440,6	471,6	541,2
		18	213,7	312,7	334,3	386,7	251,1	369,5	396,0	457,4	284,0	420,1	451,1	520,6
20	198,4	297,6	319,2	371,4	232,9	351,5	378,0	439,3	263,6	399,7	430,7	500,1		

TM = Air inlet temperature of water coil (°C)

Ti/To = Water temperature inlet/outlet (°C)

Qo = Airflow (l/s and m³/h)

kWt = Provided heating capacity (kW)

Thermal yields referred to the max. water coil capacity. The thermo regulator cokes the 3-way modulating valve limiting the inlet air temperature at desired values.

3WVM - Modulating 3-way valve

To be combined with hot water coil (optional). It is managed by the built-in microprocessor via a 0-10V signal and allows the fully automatic control of the water coil.

The valve with modulating actuator is provided already assembled and wired built-in the unit.

Valve pressure drops

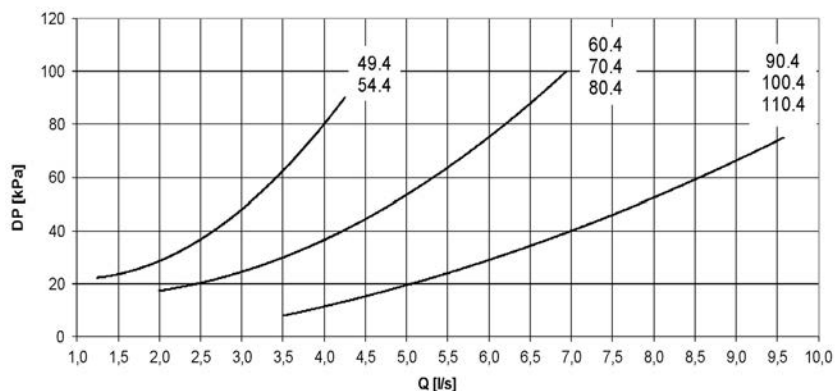

Q [l/s] = water flow-rate
Dp [kPa] = pressure drop



This accessory has to be coupled to the "CHW2 - Two-row hot water coil" option.

CHWER - Energy recovery from food refrigeration

This option makes it possible, during the winter season, to recover the heating energy produced by food storage in supermarkets, hypermarkets or food factories. It is a technical solution that recovers a significant heating resource, which is otherwise normally released outdoors.

The unit logic assigns a priority value to this function based on the heating availability of the resource, and integrates the overall output of the unit.

The option is comprised of a water exchanger, which is automatically controlled by a dedicated valve. With electrically powered units, the frost function is enabled, which forces the valve open when required.

Hot water coil pressure drops: AIR side

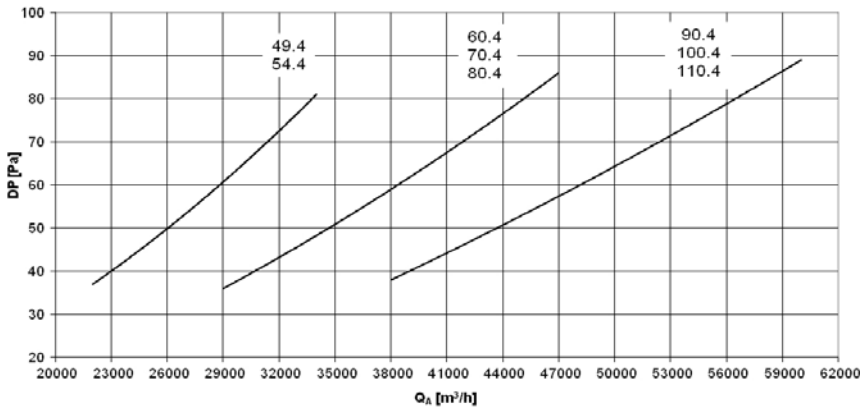

The air side pressure drops are relative to the medium air temperature of 20°C and are to be added to the pressure drops due to ducts, terminal devices and any other component that causes a drop in working discharge head.

QA [m³/h] = airflow
DP[Pa] = pressure drops

Hot water coil pressure drops: WATER side

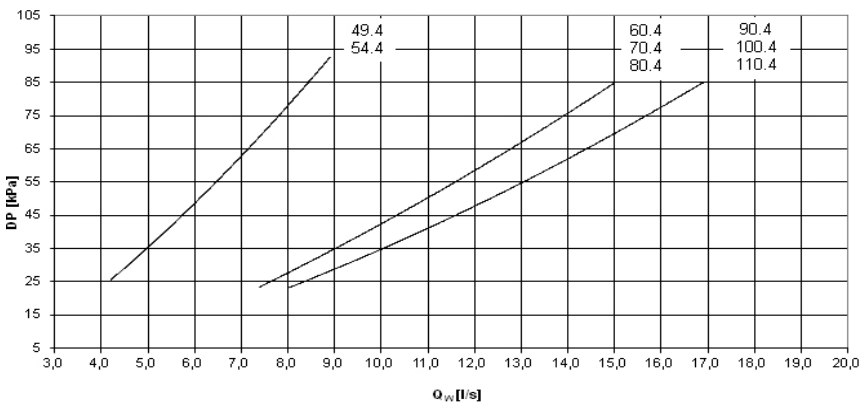

Pressure drops on the water side are calculated considering an average water temperature of 65°C

Qw [l/s] = water flow-rate
DP[kPa] = pressure drops

$$Q_w [l/s] = P / (4.186 \times DT)$$

P = Water coil heating capacity in KW
DT = Temperature difference between inlet / outlet water

This option reduces the available static pressure (supply air side).



The component requires connection to the hot water plumbing system (to be provided for by the Client).



'Electric elements', '2-row hot water coil', 'Combustion heating module' and 'Energy recovery from food refrigeration' cannot be assembled simultaneously.

Performances of water heating coil

SIZE		Ti/To (°C)									
		45 / 40	40 / 35	35 / 30	45 / 40	40 / 35	35 / 30	45 / 40	40 / 35	35 / 30	
		kWt	kWt	kWt	kWt	kWt	kWt	kWt	kWt	kWt	
49.4 54.4	Qo (m³ / h)	22000			28000			34000			
	Qo (l / s)	6111			7777			9444			
	TM (°C)	5	200,8	173,6	146,3	239,2	206,6	174,0	274,1	236,6	199,1
		10	172,6	145,5	118,4	205,5	173,1	140,7	235,5	198,4	161,0
		14	150,2	123,4	96,3	178,9	146,7	114,4	205,0	168,0	130,8
		16	139,3	112,4	85,4	165,8	133,6	101,4	190,0	153,0	115,8
		18	128,2	101,4	74,6	152,7	120,6	88,4	174,9	138,0	101,0
20	117,3	90,6	63,7	139,6	107,6	75,5	159,9	123,1	86,1		
60.4 70.4 80.4	Qo (m³ / h)	29000			38000			47000			
	Qo (l / s)	8055			10555			13055			
	TM (°C)	5	265,1	228,9	192,5	322,3	278,2	233,7	373,9	322,5	270,7
		10	227,5	191,6	155,6	276,7	232,8	188,7	321,2	269,9	218,5
		14	198,0	162,2	126,5	240,8	197,0	153,2	279,3	228,3	177,3
		16	183,3	147,7	112,0	222,9	179,2	135,6	258,6	207,7	156,8
		18	168,8	133,2	97,6	205,2	161,7	118,1	237,9	187,1	136,4
20	154,3	118,9	83,3	187,5	144,1	100,6	217,4	166,8	116,0		
90.4 100.4 110.4	Qo (m³ / h)	38000			49000			60000			
	Qo (l / s)	10555			13611			16666			
	TM (°C)	5	348,3	301,1	253,7	418,8	361,7	304,5	482,6	416,5	350,6
		10	299,3	252,4	205,4	359,8	303,2	246,4	414,7	349,3	283,5
		14	260,6	214,0	167,2	313,3	257,0	200,5	361,0	295,9	230,5
		16	241,5	195,0	148,3	290,2	234,1	177,6	334,6	269,4	204,2
		18	222,5	176,0	129,5	267,4	211,2	155,0	308,1	243,1	177,9
20	203,5	157,2	110,7	244,5	188,5	132,3	281,7	216,9	151,8		

TM = air inlet temperature of water coil (°C)

Ti/To = water temperature inlet/outlet (°C)

Qo = airflow (l/s and m³/h)

kWt = provided heating capacity (kW)

Thermal yields referred to the max. water coil capacity. The thermo regulator cokes the 3-way modulating valve limiting the inlet air temperature at desired values.

3WVM - Modulating 3-way valve for energy recovery from food refrigeration

To be combined with water coil for the energy recovery from food refrigeration. It is managed by the built-in microprocessor via a 0-10V signal and allows the fully automatic control of the water coil. The valve with modulating actuator is provided already assembled and wired built-in the unit.

Valve pressure drops

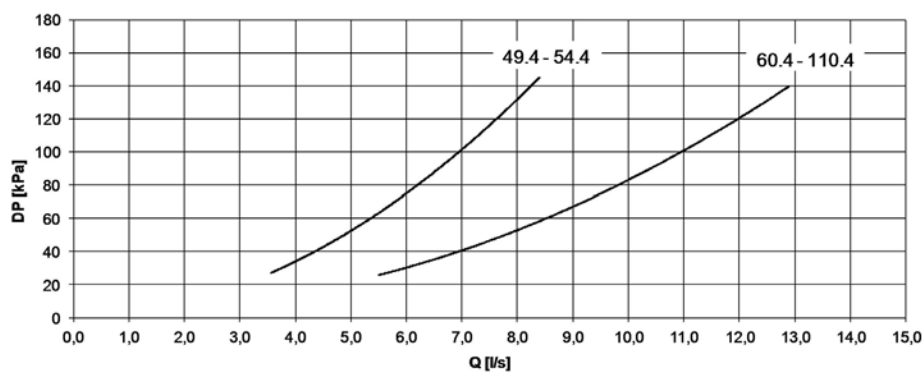

Q [l/s] = water flow-rate
DP [kPa] = pressure drops



This accessory has to be coupled to the "CHWER - Energy recovery from food refrigeration" option.

LTEMP1 - Application for low outdoor temperature

Option indicated for very cold climates, where the outside temperature can be between -10 and -30°C.

The option involves self-regulating heater thermostatically controlled able to protect the electrical panel from freezing, ensuring the correct operation.

The special version of the outdoor air damper for the application for low outdoor temperature is made of anti-seize devices that facilitate the correct control of the fresh air in every climatic situation, thanks to the teflon supporting bushings, aluminium flaps, PVC end gaskets and steel leverages to compensate expansions.

The motorised actuator is suitable for operating with low outdoor temperatures.

The devices are built-in installed and wired.



This operation involves variation of the main electrical data of the unit.



This accessory operates even when the unit is switched off provided that the power supply is maintained active and the unit continues to be connected.



It is necessary to make precautions against build up of snow and ice in front of the exhaust and outdoor air inlet locations.

PCOSM - Constant supply airflow

The original technology used eliminates the need for on-site calibration of traditional fans, as well as the time that would be required and the associated costs. The required flow rate is set on the display and maintained automatically by the unit, which controls the speed of the fan sections. During the installation and start-up phase, the unit controls to the effective pressure drop in the air distribution and diffusion system. Furthermore, during its entire operating life, the progressive fouling of the air filters is automatically compensated for thanks to this system.

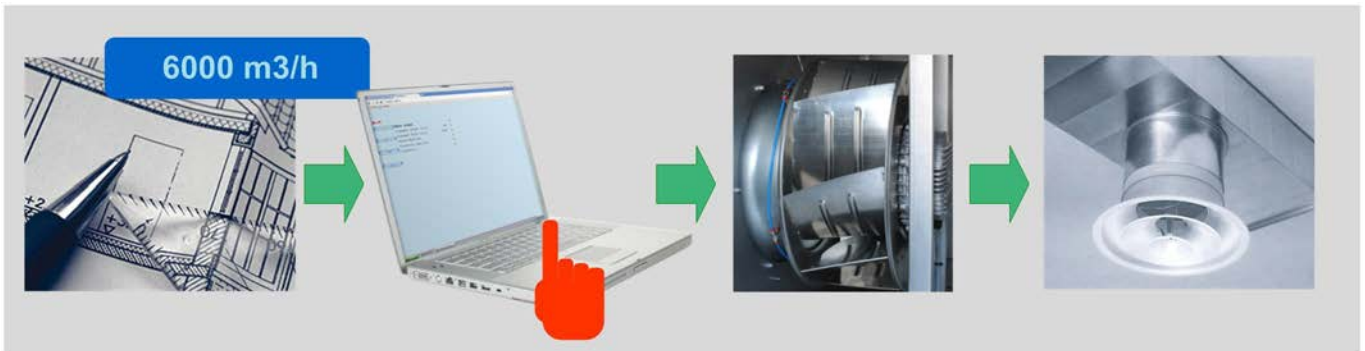

PVAR - Variable airflow

Option that enables the automatic variation of the treated air flow, according to the effective load. This allows great energy saving, thanks to the reduction of ventilation electrical consumptions. The minimum flow value equal to 60% of the nominal one occurs during the partial load and satisfied set-point operation. As a result, the supply temperature remains unchanged either during full load operation or partial load operation. The device also includes the functions of configuration of the nominal flow directly on the unit display and its automatic control to compensate the dirtying of the air filters.



This option already includes the device for controlling the airflow, called 'PCOSM - Supply constant airflow', which must not be selected.



When sizing the distribution and diffusion of the air, keep into consideration that the airflow varies from the nominal value (at full load, in FREE-COOLING mode and during the defrosting phases) to the minimum value, equal to 60% of the nominal flow (at partial load).

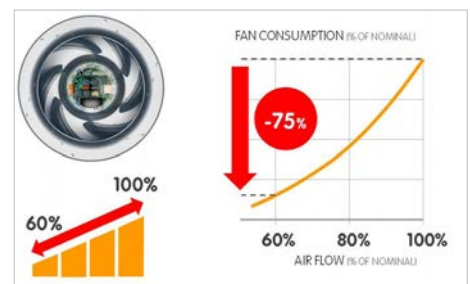

CPHG - Hot gas re-heating coil

This option is recommended during the summer when the intake air dehumidification is required.

The air flow to enter the room may contain a higher level of humidity than desired. The dehumidification process is used to reduce it. The air flow is first cooled in the handling coil with separation of condensation. It is then freely re-heated to maintain the desired condition of comfort in the served room.

The re-heat coil is located behind the handling coil and is activated by diverting a flow of hot refrigerant gas downstream from the compressors through the action of a dedicated solenoid valve.

The process starts operating based on the humidity set-point established by the user.

With respect to traditional devices, such as electrical electric elements or hot water coils, use of the re-heat coil does not consume any extra energy. It also lowers refrigerant condensation temperature, which provides two positive effects: power absorbed by the compressors is considerably reduced, and at the same time, cooling capacity is increased, resulting in greater efficiency (EER).

Ambient humidity is measured by means of a return humidity probe, which is provided already assembled and wired built-in the unit.

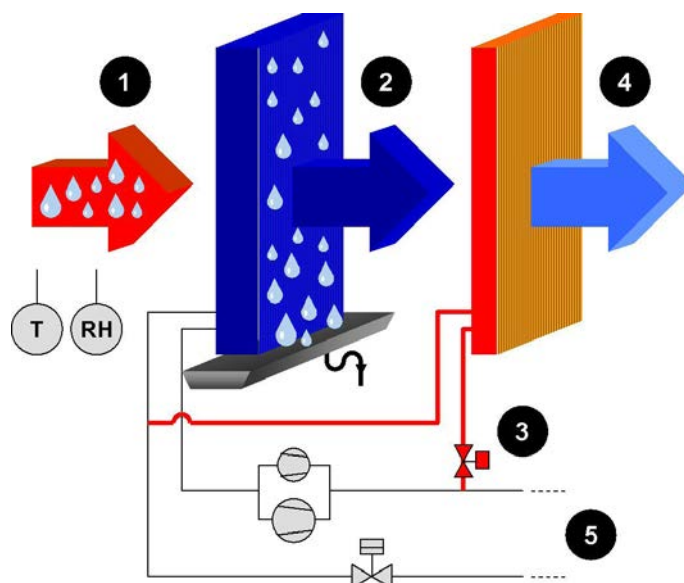

- 1 Outdoor air and humidity / temperature probe
- 2 Chilled and dehumidified air in the internal exchanger (evaporator)
- 3 Automatic hot gas pump valve
- 4 Air treated by the post-heating exchanger
- 5 External exchanger (condenser)

Indicative scheme - not in scale

This option reduces the available static pressure (supply air side).

Performances of hot gas re-heating coil

SIZE		OUTDOOR AIR TEMPERATURE (°C)															
		25	27	30	32	35	25	27	30	32	35	25	27	30	32	35	
		kWt	kWt	kWt	kWt	kWt	kWt	kWt	kWt	kWt	kWt	kWt	kWt	kWt	kWt	kWt	
49,4	Qo (m3 / h)	22000					26000					34000					
	Qo (l / s)	6111					7222					9444					
	Ta (°C)	10	45,9	49,5	54,8	58,4	63,9	51,2	55,2	61,2	65,3	71,4	59,2	63,8	70,8	75,5	82,6
		12	42,3	45,8	51,2	54,8	60,2	47,2	51,2	57,1	61,1	67,2	54,5	59,1	66,1	70,8	77,8
		14	38,7	42,2	47,5	51,1	56,5	43,2	47,1	53,0	57,1	63,1	49,9	54,5	61,3	66,0	73,0
		16	35,2	38,7	44,0	47,5	52,9	39,2	43,1	49,0	53,0	59,0	45,2	49,8	56,7	61,3	68,3
		18	31,6	35,1	40,4	43,9	49,3	35,2	39,2	45,0	49,0	55,0	40,7	45,2	52,0	56,6	63,6
20	28,1	31,6	36,8	40,3	45,7	31,3	35,2	41,1	45,0	50,9	36,1	40,6	47,4	52,0	58,9		
54,4	Qo (m3 / h)	22000					29000					34000					
	Qo (l / s)	6111					8056					9444					
	Ta (°C)	10	46,4	50,0	55,4	59,0	64,6	54,6	58,8	65,2	69,6	76,1	59,8	64,5	71,5	76,3	83,5
		12	42,7	46,3	51,7	55,3	60,8	50,3	54,5	60,9	65,2	71,7	55,1	59,7	66,7	71,5	78,6
		14	39,1	42,7	48,0	51,6	57,1	46,0	50,2	56,5	60,8	67,3	50,4	55,0	62,0	66,7	73,8
		16	35,5	39,1	44,4	48,0	53,4	41,7	45,9	52,2	56,5	62,9	45,7	50,3	57,2	61,9	69,0
		18	32,0	35,5	40,8	44,3	49,8	37,5	41,7	48,0	52,2	58,6	41,1	45,7	52,5	57,2	64,2
20	28,4	31,9	37,2	40,7	46,1	33,4	37,5	43,8	47,9	54,3	36,5	41,1	47,9	52,5	59,5		
60,4	Qo (m3 / h)	29000					33000					47000					
	Qo (l / s)	8056					9167					13056					
	Ta (°C)	10	61,7	66,4	73,5	78,4	85,7	67,3	72,5	80,3	85,6	93,6	81,8	88,1	97,7	104,2	113,9
		12	56,8	61,6	68,7	73,5	80,8	62,0	67,2	75,0	80,2	88,2	75,4	81,7	91,2	97,6	107,4
		14	52,1	56,8	63,9	68,6	75,9	56,8	62,0	69,7	74,9	82,8	69,0	75,3	84,7	91,2	100,8
		16	47,4	52,0	59,1	63,8	71,0	51,7	56,8	64,5	69,7	77,5	62,7	69,0	78,3	84,7	94,3
		18	42,7	47,3	54,3	59,0	66,2	46,5	51,6	59,3	64,4	72,2	56,4	62,6	72,0	78,3	87,9
20	38,0	42,6	49,6	54,3	61,4	41,4	46,5	54,1	59,2	67,0	50,2	56,4	65,7	72,0	81,5		

SIZE		OUTDOOR AIR TEMPERATURE (°C)															
		25	27	30	32	35	25	27	30	32	35	25	27	30	32	35	
		kWt	kWt	kWt	kWt	kWt	kWt	kWt	kWt	kWt	kWt	kWt	kWt	kWt	kWt	kWt	
70,4	Qo (m3 / h)	29000					37000					47000					
	Qo (l / s)	8056					10278					13056					
	Ta (°C)	10	62,3	67,1	74,3	79,2	86,6	72,0	77,5	85,9	91,6	100,2	82,6	89,0	98,7	105,2	115,1
		12	57,4	62,2	69,4	74,2	81,6	66,4	71,9	80,2	85,9	94,4	76,1	82,5	92,1	98,6	108,4
		14	52,6	57,4	64,5	69,3	76,6	60,8	66,3	74,6	80,2	88,7	69,7	76,1	85,6	92,1	101,8
		16	47,8	52,6	59,7	64,5	71,7	55,2	60,7	68,9	74,5	83,0	63,3	69,7	79,1	85,6	95,3
		18	43,1	47,8	54,9	59,6	66,8	49,7	55,2	63,4	68,9	77,3	57,0	63,3	72,7	79,1	88,8
20	38,4	43,1	50,1	54,8	62,0	44,3	49,7	57,9	63,4	71,7	50,7	57,0	66,4	72,7	82,3		
80,4	Qo (m3 / h)	29000					44000					47000					
	Qo (l / s)	8056					12222					13056					
	Ta (°C)	10	62,9	67,8	75,0	80,0	87,4	79,6	85,7	95,0	101,3	110,8	83,4	89,9	99,7	106,3	116,2
		12	58,0	62,8	70,1	75,0	82,4	73,3	79,5	88,7	95,0	104,4	76,9	83,3	93,0	99,6	109,5
		14	53,1	57,9	65,1	70,0	77,4	67,1	73,3	82,4	88,7	98,1	70,4	76,8	86,5	93,0	102,9
		16	48,3	53,1	60,3	65,1	72,4	61,0	67,1	76,2	82,4	91,8	63,9	70,3	79,9	86,4	96,2
		18	43,5	48,3	55,4	60,2	67,5	54,9	61,0	70,0	76,2	85,5	57,6	63,9	73,4	79,9	89,7
20	38,8	43,5	50,6	55,4	62,6	48,9	54,9	64,0	70,0	79,3	51,2	57,5	67,1	73,4	83,1		
90,4	Qo (m3 / h)	38000					51000					60000					
	Qo (l / s)	10556					14167					16667					
	Ta (°C)	10	80,5	86,6	95,9	102,2	111,7	96,1	103,6	114,7	122,3	133,7	105,0	113,1	125,3	133,6	146,1
		12	74,2	80,4	89,6	95,9	105,3	88,7	96,1	107,2	114,7	126,1	96,8	104,9	117,0	125,3	137,7
		14	68,0	74,2	83,3	89,6	99,0	81,3	88,6	99,7	107,2	118,4	88,7	96,8	108,8	117,0	129,4
		16	61,9	68,0	77,1	83,3	92,7	73,9	81,2	92,2	99,6	110,9	80,6	88,7	100,7	108,8	121,1
		18	55,8	61,9	71,0	77,1	86,4	66,6	73,9	84,8	92,2	103,4	72,6	80,6	92,5	100,7	112,9
20	49,8	55,8	64,8	70,9	80,2	59,3	66,6	77,5	84,8	95,9	64,7	72,6	84,5	92,6	104,7		
100,4	Qo (m3 / h)	38000					56000					60000					
	Qo (l / s)	10556					15556					16667					
	Ta (°C)	10	80,9	87,0	96,4	102,7	112,3	100,9	108,8	120,5	128,5	140,4	105,5	113,7	126,0	134,3	146,8
		12	74,6	80,8	90,1	96,4	105,8	93,1	100,8	112,5	120,5	132,4	97,3	105,4	117,6	125,9	138,4
		14	68,4	74,5	83,8	90,0	99,5	85,3	93,1	104,6	112,5	124,4	89,1	97,3	109,4	117,6	130,0
		16	62,2	68,3	77,5	83,7	93,1	77,6	85,3	96,8	104,6	116,4	81,0	89,1	101,2	109,4	121,7
		18	56,1	62,2	71,3	77,5	86,8	69,9	77,5	89,0	96,8	108,5	73,0	81,0	93,0	101,2	113,5
20	50,0	56,0	65,2	71,3	80,6	62,2	69,8	81,2	89,0	100,7	65,0	73,0	84,9	93,0	105,2		
110,4	Qo (m3 / h)	38000					56000					60000					
	Qo (l / s)	10556					15556					16667					
	Ta (°C)	10	81,3	87,5	96,9	103,3	112,8	101,4	109,3	121,1	129,1	141,1	106,1	114,2	126,6	135,0	147,6
		12	75,0	81,2	90,5	96,8	106,4	93,6	101,4	113,1	121,1	133,1	97,8	105,9	118,2	126,6	139,1
		14	68,7	74,9	84,2	90,5	100,0	85,7	93,5	105,2	113,1	125,0	89,6	97,7	109,9	118,2	130,7
		16	62,5	68,7	77,9	84,1	93,6	78,0	85,7	97,3	105,2	117,0	81,4	89,5	101,7	109,9	122,3
		18	56,4	62,5	71,7	77,9	87,3	70,2	77,9	89,4	97,3	109,1	73,4	81,4	93,5	101,7	114,0
20	50,3	56,3	65,5	71,6	81,0	62,6	70,2	81,6	89,4	101,2	65,3	73,3	85,3	93,5	105,8		

Ta = leaving air temperature from the handling coil and entering the post-heating coil

Qo = airflow (l/s)

kWt = heating capacity (kW)

The reheating coil is powered by the cold gas bled from the condensing coil.

As the condensation hot gas temperature is linked to the outdoor air temperature, the indicative potentials of the post-heating coil are expressed according to the outdoor air temperature.

HSE - Immersed electrodes steam humidifier

This device is suitable for winter operation when humidity is required for the ambient without cooling the air flow.

The automatic modulating control allows you to adjust the steam production and its relative management costs to the actual requirements.

Available in different capacities, the device is suitable for using soft water having medium conductivity and is equipped with: water load solenoid valve, disposable cylinder, water drainage solenoid valve, distribution nozzle, control electronic board to verify the water level, conductivity, anti-foam device, water drainage manual forcing. To ensure maximum hygiene, the cylinder can automatically empty after a determined period of stand-by.

The accessory is installed inside the unit and is connected to the electrical panel of the unit.

Ambient humidity is measured by means of a return humidity probe, which is provided already assembled and wired built-in the unit.



Matching of immersed electrode and steam humidification module

Size	49.4	50.4	60.4	70.4	80.4	90.4	100.4	110.4
8 kg/h	√	√	√	√	√	√	√	√
15 kg/h	√	√	√	√	√	√	√	√

This option involves variation of the main electrical data of the unit.

This accessory requires connection to a water supply network and discharge water circuit with adequate frost protection. Requires its own power supply and have to be connected to the unit. Installation and wiring to customer care.

HWS - Water to waste evaporating wet-deck humidifier

This option is recommended when quick, efficient humidification of the served room is required. Humidification of the air mixture occurs by passing the air flow through a honeycomb package that is kept humid at all times by a series of nozzles that inject water in small drops. The reserve of water for treatment is taken directly from the water mains. During operation, the pure water vapour is mixed with the air currents. The remaining part, enriched with mineral salts, is collected in the tub and eliminated. The constant exchange of water ensures cleaning of the evaporation septum and provides maximum limitation of the formation and proliferation of Legionnaire's Disease. With this option, energy consumption for water evaporation is limited. Whenever the packaged humidifier is active, in addition to humidifying, adiabatic cooling of the air takes place, which is constantly compensated for by the thermal control device. Direct connection to the plumbing system eliminates the need for special water treatment and easy control of the humidification process by means of the measuring and adjusting device of the water flow rate provided standard.

The accessory is installed inside the unit and is connected to the electrical panel of the unit.

Ambient humidity is measured by means of a return humidity probe, which is provided already assembled and wired built-in the unit.



Size		49.4	54.4	60.4	70.4	80.4	90.4	100.4	110.4
TA (°C) D.B.	TA (°C) W.B.	kg/h	kg/h	kg/h	kg/h	kg/h	kg/h	kg/h	kg/h
30	15,1	150	167	190	213	253	294	323	346
35	17,6	187	209	238	266	317	367	403	432
40	19,8	228	254	289	324	385	447	491	526

Ta D.B.= dry bulb temperature of inlet air to the wet deck.

Ta W.B.= wet bulb temperature of inlet air to the wet deck.

Approximate values of the maximum rate of steam released by the steam humidifier to the air to obtain controlled thermal and humidity conditions in supply. The data refer to a unit with standard airflow in supply.

This option reduces the available static pressure (supply air side).

This accessory requires connection to a water supply network and discharge water circuit . Installation and wiring to customer care.

FES - H10 high efficiency electrostatic air filter

Class H10 high-efficiency filters are additional filtering components with an active electrostatic system. Solid or liquid particles contained in the air flow are trapped by an electrical field. The air flow through the filter is affected in two main phases: release of an electrical charge to the particles (ionization), and capture of the particles by electrostatic deposit (captivation). Periodically the filters must be cleaned to remove the captured particles (washing).



The filters are able of trapping fine dusts, some types of viruses and micro-organisms (anti-bacterial action) with very modest pressure drops. The range of use normally includes fine powders that measure less than 1 µm. Typical pollutants are cigarette smoke (0.5÷0.3 µm), oily vapours (1÷0.2 µm), PM10 (particles < 10 µm), PM2.5 (particles < 2.5µm), PM1 (particles < 1µm), etc.

The clogging of the electric filter is signalled by a sensor that allows to schedule the periodic maintenance, which can be easily performed by washing in water with a special non-aggressive detergent for aluminium.

The greater initial cost, as compared to a traditional pocket filter, is recovered quickly since the electrostatic filters last for the entire life of the unit, whereas pocket filters require periodic replacement.

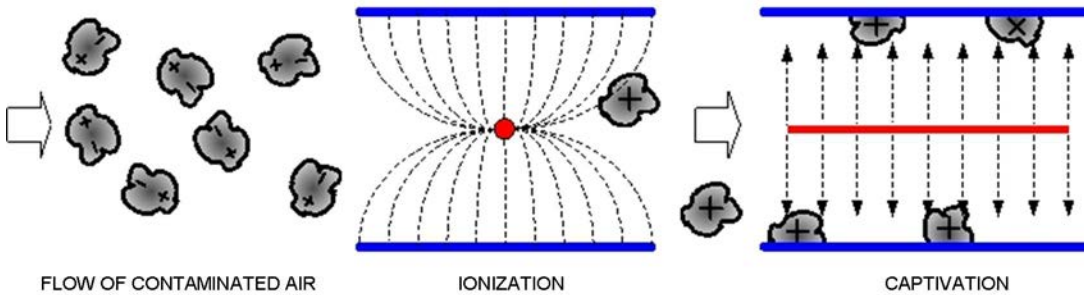

This option reduces the available static pressure (supply air side).



The electronic filters are not suited to filter water steams also in low concentration, oily vapours, large amounts of dust, shavings, powdered iron filings and residues generally, gas. The electronic filters have to absolutely avoid all the following substances: powdered metals also fine, smoke produced by combustion of organic materials and not, flour dusts, dusts and vapours of explosive environments.

F7 - F7 high efficiency air filter

The class F7 are filtering components that are in addition to the standard G4 filters, for more effective filtering. They are widely used in air conditioning systems and industrial applications that require suitable performance concerning fine dusts and particles with dimensions greater than 1 µm.



Class F7 filters are made of fibreglass paper, pleated with constant calibrated spacing, mounted on a metallic frame; the ample filtering surface reduces air side pressure drops. Class F7 filters must be replaced after reaching their limits of dirtiness with scheduled periodic maintenance. An optional accessory, dirty filter differential switch, can be fitted to signal when admissible limit of fouling has been reached so as not to excessively reduce the airflow with respect to the nominal value.

PSAF - Clogged filter differential pressure switch air side

It makes it possible to detect and signal (with a suitable alarm) when the dirtiness of the air filter reaches its maximum level. This provides the unit operator with information on when filter maintenance is required. The detection signal is installed in the unit. It is already connected to the electrical panel and pre-calibrated in the factory. Calibration can be modified by an authorized personnel.



PAQC - Air quality probe for the CO2 rate check

This option is recommended for areas with highly variable crowding. The probe measure the amount of CO2 in the environment and initiates a 0/10V proportional signal. Based on the received signal, the controller regulates amount of outdoor air necessary for IAQ ventilation and thus minimises energy used for treatment.

The probe is installed and wired built-in the unit and is located in the return air duct of the unit.



PAQCV - Air quality probe for the CO2 and VOC rate check

The option is recommended in areas with tobacco smoke, formaldehyde (from solvents, deodorants, glues, paints, detergents, food preparation, etc). The probe measures the rate of CO2 and VOC (volatile organic compounds) in the environment and initiates a 0/10V proportional signal. Based on the received signal, the controller regulates amount of outdoor air necessary for IAQ ventilation and thus minimises energy used for treatment.

The probe is installed and wired built-in the unit and is located in the return air duct of the unit.



DESM - Smoke detector

This option allows detection of smoke in the room by analyzing the return air. The Tyndal-effect increased sensitivity smoke detector is perfect for ventilation ducts since it is able to detect rarefied smoke in high-speed air flows. Smoke detection occurs using a photo-optical system with a labyrinth chamber. The alarm signal is processed by a built-in micro-processor which verifies the condition and sends a message to the unit controller such as smoke alarm, failure, or service required. The device is installed inside the return duct and it is made up of a sensor, installed inside the return piping, and of a controller that is located on the outside duct.



Control logics in the event of alarm signal

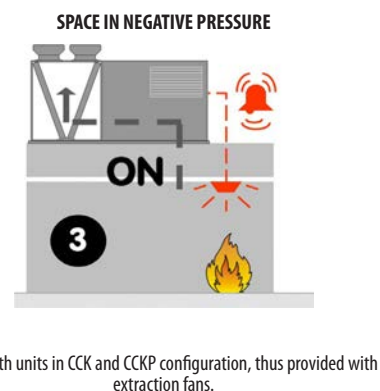
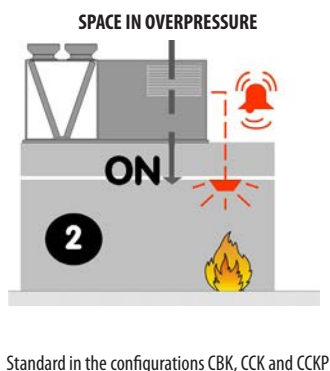
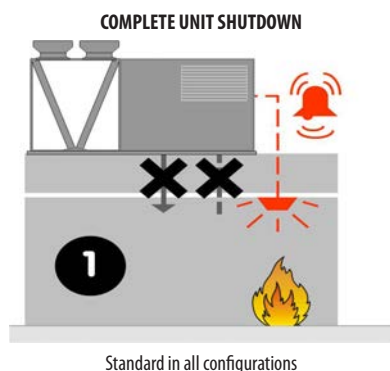

The unit is able to manage the signal coming from a fire detection system or fire control unit installed built-in, activating one of the logics illustrated, which can be set by parameters. In presence of alarm signal, the compressors are always switched off; moreover, the remote ON-OFF is disabled together with the switch on/off control from keypad. The unit is manually reset. Rooftop units cannot be used as fume extractor.

Any fire detection devices on board the unit must be considered as an auxiliary safety system, and, accordingly, must not be a replacement for any fire detection devices in the room.

CREFB - ECOBREEZE external section fans consumption reduction device

Option indicated to reduce the ventilation electric energy consumption considerably and limit sound emissions inside the external section of the unit. ECOBREEZE logic allows the external axial fans to operate at a variable rotation speed, according to the operation conditions of the cooling circuit. Reducing the speed when the heat load is reduced, benefits the sound emissions, especially during the night, when sensitivity to noise is enhanced. During summer operation, fans can further increase their speed, to respond to situations in which operation limits are temporarily exceeded. ECOBREEZE option uses special fans powered by brushless electrical motors, with complete electronic control, and distinguished by a very high efficiency.



VENH - High static pressure electric fans

A higher capacity fan section is available for applications requiring high supply and return static pressure. The option is comprised of radial fans coupled directly to electronically controlled motors (brushless). When you select a unit on the www.clivet.com website, if you enter the air flow-rate, the available supply and return pressure and the accessories that determine the pressure drop on the air side, you will be automatically shown a selection of high static pressure fans, when required.

Option that cause the variation of the unit electrical data.



FCE - Enthalpic FREE-COOLING

This option is used to reduce energy consumption and compressor wear by using the outdoor air as an energy source to lower the thermal loads and ambient humidity. The temperature control compares the temperature and the humidity between the outdoor environment and the served environment and decides the amount of fresh air needed to guarantee the correct temperature and humidity set-points in the environment, keeping the compressors shut off.

The air humidity, both outside and inside the environment, is measured by means of humidity probes on the outdoor and return air intake, which are provided already installed and wired on the unit.

MHP - High and low pressure gauges

Allows the pressure measurement of the refrigerant to the compressor intake and supply, making the inspection of these parameters easier for the technicians involved in the management of the unit.

The two liquid pressure gauges and corresponding pressure sockets are installed built-in the unit in an easily accessible location.



PCM0 - Sandwich panels of the handling zone in M0 fire reaction class

Option indicated when, by law, the air treatment area must have metallic internal walls made with fire-proof insulating material. Sandwich panels with dual walls made of steel sheet metal with fire-proof insulation made of Rockwool ((90 kg/m³) comply with the French standards, which require "M0" reaction to fire class.

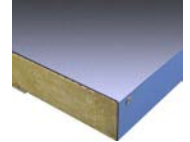

CCCA - Copper / aluminium coil with acrylic lining

Coils with copper pipes and aluminium fins with acrylic lacquering. Can be used in settings with moderately aggressive low saline concentrations and other chemical agents.

Attention!

- Cooling capacity variation -2.7%
- variation in compressor power input +4.2%
- operating range reduction -2.1°C

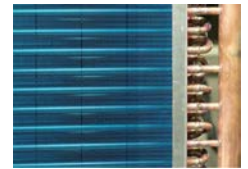

CCCA1 - Copper/aluminum coil with Fin Guard (Silver) treatment

A treatment which offers an optimal thermal exchange and guarantees and protects the finned coil exchangers from corrosion over time. Can be used in settings with very aggressive saline concentrations and other chemical agents in the air thus maintaining the performance of the coils over time.



Option available on request.



CCCC - Copper / copper coil

Coils with copper pipes, copper fins and brass structure. Can be used in settings with moderately aggressive saline concentrations and other chemical agents. The options are available for:

- external coil;
- internal coil;
- hot water coil;
- re-heating coil.



This option is not suitable for application in sulphuric environments.



Option available on request.

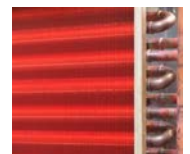

SFSTC - Progressive compressor start-up Soft starter

This option is also known as "Soft starter". An electronic device which automatically starts up the compressors gradually, reducing the starting current for the unit by around 40% in comparison with the nominal value.

This results in the electrical capacity system and the related protection devices being sized with lower parameters, thus having a lower initial investment cost.

The device is installed and wired built-in the unit.

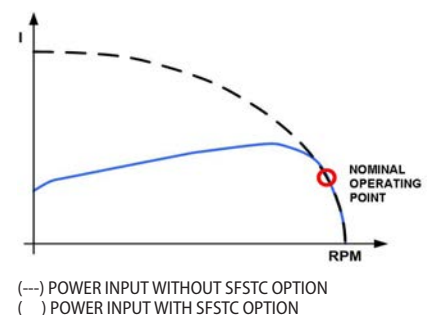

MOB - RS485 Serial port with Modbus protocol.

It allows the serial connection to supervision systems, using Modbus as the communication protocol. It allows the access to the complete list of operating variables, controls and alarms.

The device is installed and wired built-in the unit.



The total length of each serial line do not exceed 1000 meters and the line must be connected in bus typology (in/out).

LON - RS485 Serial port with LonWorks protocol

It allows the serial connection to supervision systems, using LonWorks as the communication protocol. It allows access to a list of operating variables, control and alarms compliant with the Echelon standard.

The device is installed and wired built-in the unit.



The configuration and management activities for the LonWorks networks are the responsibility of the Client.



LonWorks technology uses the LonTalk® protocol for communicating between the network nodes. Contact the service supplier for further information.



The total length of each serial line do not exceed 1000 meters and the line must be connected in bus typology (in/out).

BACIP - BACnet-IP serial communication module

Allows to perform the connection to supervision systems by using BACnet-IP as a communication protocol. It allows to access the entire list of operating variables, controls and alarms.

The device is installed and wired built-in the unit.



The configuration and management activities for the BACnet networks are the responsibility of the Client.



The total length of each serial line do not exceed 1000 meters and the line must be connected in bus typology (in/out).

PFCP - Power factor correction capacitors (cosfi > 0.9)

The component is necessary to lower the phase difference between current and voltage in the electromagnetic components of the unit, such as asynchronous motors. By re-phasing it is possible to reduce the intensity of the line current by reducing a part of the power of the mains (reactive power). This leads to an economic benefit which the energy provider grants to the final user. The component makes it possible to bring the cosfi power factor to values which on average are greater than 0.9.

The device is installed and wired built-in the unit.



MF2 - Multifunction phase monitor

The phase monitor controls the electrical parameters of the power line to the unit. It works on the command circuit and orders the unit to be switched off when one of the following cases is present: when the phase connections do not respect the correct sequence, or when there is over voltage or under voltage for a certain amount of time (limit values of over and under voltage and the time interval can be manually and separately set). When the line conditions are re-established, the unit is re-armed automatically.

The device is installed and wired built-in the unit.



The device prevents sudden changes of voltage; however, the voltage must always be in a range between 380V and 480V.



NCRC - Remote control with user interface: not required

If you choose this option, the unit is supplied without a graphical control user interface, although it retains all the features. Option that can be chosen when there is a supervision system or another remote management device.



The remote control with user interface can be still used in conjunction with a supervision system and in general with a serial connection.



Accessories separately supplied

SIX - Service interface

The device allows to fully control the unit for start-up and maintenance operations conducted by authorised technical personnel. It must be connected on the outside of the unit via the RJ45 connector and the 1.5m connection cable that can be further extended. The device can be easily applied on the unit's surface thanks to the magnetic support. It is protected from the elements thanks to the IP68 protection. The control has a backlit screen, comfortable buttons and a graphical interface with a browsing menu and submenu.



All device functions can be repeated with a normal portable PC connected to the unit with an Ethernet cable and equipped with an internet navigation browser.

AMRX - Rubber anti-vibrating dampers

The rubber antivibration mounts must be fixed to designated housings on the support stringers and are used to dampen vibrations produced by the unit, thereby reducing the noise transmitted to the support structures. They are flexible bodies able to dampen axial and tangential stresses and maintain the mechanical properties almost constant over time thanks to high resistance materials of which they are made.



Alternatively, rubberized neoprene anti-vibration strips may be used on the unit longitudinal support members (not supplied by Clivet).

CLMX - Clivet Master System

CLIVET MASTER SYSTEM is the ideal system for the remote and centralised control of the CLIVETPack and SMARTPack climate control units. It can manage up to eight units connected with a serial connection. It includes a box for wall installation, as well as the electronic power supply and serial communication devices, a controller with a touch-screen display and a USB port at the front used to export the alarm log. The device allows to easily and intuitively access all the information on the status of the system and the climate control units. It also provides:

- auto-detection of units connected,
- setting all unit parameters,
- setting of the zone set-point
- unit status display,
- control and management of the alarms and creation of an alarm log,
- hourly operation scheduling (ON / OFF / ECO),
- rotation of the units even for individual areas,
- temperature, humidity and air quality trends
- automatic language management (English, Italian, French, Spanish and German)



The component must be combined with the RS485 serial port option with Modbus protocol built-in of each rooftop



Operating temperature from 0°C to 50°C with relative humidity lower than 90% without condensate

P-MATIC - Clivet supervisory system

Clivet P-MATIC is a Clivet supervision system that allow to schedule and manage all the installed Clivet conditioning units, optimizing their functional operating and the others systems in order to reduce the energy consumption.

The software navigation is easy and intuitive, thanks to the tridimensional graphic interface. It is so possible to change complex activities of system operating into simple and reliable activities made by the Customer.

Clivet P-MATIC let to visualize the maintenance status of the conditioning units, valuate and manage the alarms.

The user operates on the system, through the supervision Workstation or the user interface display on the PLC (Programmable Logic Controller), according to the controller installation component. The data Exchange between the Workstation, the units and the remote control electronic devices is performed by serial/bus network on RS485 standard communication protocol, or by LAN network (Local Area Network) Ethernet TCP/IP.

The integrated remote monitoring software allows accessing to the Clivet on-line technical assistance services.

For further information refer to the technical documentation.



RCX - Roof curb

Option that allows to connect the unit to the building roof, ideal with downflow supply and return. It is made up of two part, a solid steel frame for the air duct connection and a adjustment support in height. Both parts are made of galvanized steel with a steel rain cover profile painted in the same unit colour. It has an adequate support and a duct connection simplification. It is supplied not assembled and it has to be assembled directly in the construction site, to facilitate the transport and installation. It is complete with adjusting screws to adapt to any slopes or difference in height of the cover. Once the frame is assembled, it will be necessary to insulate and seal the roof curb to the roof to guarantee the resistance to atmospheric agents, later it will be necessary only to place the unit.

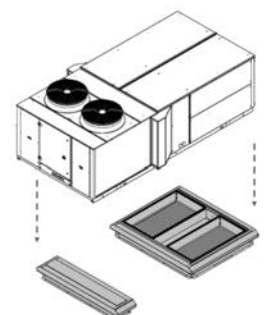

Option not available with gas module.

Performance

On the web site www.clivet.com are available the performances of the CAK, CBK, CCK and CCKP configuration.

Size 49.4 CCKP configuration

Cooling performance with 30% of outdoor and exhaust air

Air flow	Ta (°C) D.B./W.B.	Outdoor air temperature °C D.B/W.B.																							
		20 / 12				25 / 18				30 / 22				35 / 24				40 / 25				45 / 26			
		kWf	kWs	kWe	EER	kWf	kWs	kWe	EER	kWf	kWs	kWe	EER	kWf	kWs	kWe	EER	kWf	kWs	kWe	EER	kWf	kWs	kWe	EER
22000 m³/h	22 / 16	150,9	112,9	28,5	5,29	166,3	116	32,1	5,18	166	112,3	36	4,61	160,4	112,9	40	4,01	152,3	115,4	44,6	3,41	152,7	117,3	49,7	3,07
	24 / 17	154,2	116,6	28,7	5,37	168,6	119,6	32,3	5,22	168,9	116,2	36,2	4,67	163,3	117,3	40,2	4,06	154,4	119,5	44,8	3,45	155,6	123,6	51,3	3,03
	26 / 18	157,2	120,3	28,9	5,44	166	119,9	32,5	5,11	171,7	120,1	36,5	4,70	165,9	121,2	40,4	4,11	156,8	123,2	45	3,48	162,2	129,1	52,6	3,08
	27 / 19	160,8	119,7	29,1	5,53	166,4	117,8	32,7	5,09	171,8	118,2	36,7	4,68	168,7	121,2	40,7	4,14	160	122,7	45,3	3,53	167,4	130	53,3	3,14
	28 / 20	164,5	119,1	29,3	5,61	166,8	115,7	32,9	5,07	172	116,2	36,9	4,66	171,5	121,1	40,9	4,19	163,5	122,2	45,6	3,59	172,9	130,8	54,1	3,20
	30 / 22	172,1	117,6	29,7	5,79	174	113,9	33,4	5,21	172,4	112,1	37,4	4,61	178,1	119,7	41,4	4,30	170,6	120,9	46,1	3,70	-	-	-	-
26000 m³/h	22 / 16	157,1	119,5	28,9	5,44	171,9	123,6	32,5	5,29	171,3	119,5	36,4	4,71	166,1	119,7	40,3	4,12	158,3	121,6	45,1	3,51	153,2	126,8	50	3,06
	24 / 17	160,6	123,6	29,1	5,52	174,5	127,4	32,7	5,34	174,2	124,1	36,6	4,76	169,3	124,5	40,6	4,17	160,1	126,7	45,3	3,53	159,6	133,7	51,4	3,11
	26 / 18	163,9	127,8	29,3	5,59	172,4	127,5	32,9	5,24	176,8	128,8	36,9	4,79	172	129	40,8	4,22	161,7	132	45,5	3,55	168,2	139,4	52,8	3,19
	27 / 19	167,7	127,2	29,4	5,70	173	125	33,1	5,23	177,1	126,5	37,1	4,77	174,9	128,7	41,1	4,26	165,1	131,5	45,8	3,60	173,8	140,3	53,5	3,25
	28 / 20	171,5	126,5	29,6	5,79	173,8	122,5	33,3	5,22	177,4	124,2	37,3	4,76	177,9	128,3	41,4	4,30	168,6	130,9	46,1	3,66	179,5	141,1	54,2	3,31
	30 / 22	179,3	125	30	5,98	180,9	120,6	33,8	5,35	178	119,5	37,8	4,71	184,5	126,9	41,9	4,40	175,8	129,6	46,8	3,76	-	-	-	-
34000 m³/h	22 / 16	165,5	132,8	29,3	5,65	181,7	134,9	33,1	5,49	180,3	131,2	36,9	4,89	173,9	132	40,9	4,25	164,7	136,3	45,7	3,60	162,7	142,3	50,7	3,21
	24 / 17	169,4	137,3	29,5	5,74	184,1	140,2	33,3	5,53	183,3	136,7	37,2	4,93	177	138,1	41,2	4,30	167,4	141,3	46	3,64	169,7	151,7	52,4	3,24
	26 / 18	173,1	142,1	29,7	5,83	181,5	141	33,5	5,42	186,3	142	37,4	4,98	179,6	143,9	41,4	4,34	169,8	146,4	46,3	3,67	178,4	157,6	53,5	3,33
	27 / 19	177	141,2	29,9	5,92	181,9	138,3	33,7	5,40	186,4	139,5	37,7	4,94	182,6	143,7	41,7	4,38	173	146,3	46,6	3,71	183,8	158,7	54	3,40
	28 / 20	181	140,3	30,1	6,01	182,4	135,6	34	5,36	186,6	136,8	37,9	4,92	185,5	143,4	42	4,42	176,4	146,2	46,8	3,77	189,2	159,7	54,4	3,48
	30 / 22	189	138,5	30,5	6,20	189,9	133,5	34,4	5,52	187,1	131,4	38,5	4,86	192,1	142	42,5	4,52	183,4	145,8	47,4	3,87	-	-	-	-

Heating performance with 30% of outdoor and exhaust air

Airflow	Ta (°C) DB	Outdoor air temperature °C D.B/W.B.																	
		-7 / -8			-5 / -6			0 / -1			2 / 1			7 / 6			12 / 11		
		kWt	kWe	COP	kWt	kWe	COP	kWt	kWe	COP	kWt	kWe	COP	kWt	kWe	COP	kWt	kWe	COP
22000 m³/h	10	128.4	23.1	5,56	134,8	23,9	5,64	150,2	26,3	5,71	156,2	27,3	5,72	172,3	30,1	5,72	188,2	33,3	5,65
	15	128.7	25.0	5,15	134,7	25,8	5,22	152,2	28,2	5,40	159,3	29,4	5,42	174,4	32,5	5,37	190	36	5,28
	18	128.6	26.0	4,95	134,9	27	5,00	152,4	29,5	5,17	159,2	30,7	5,19	175,2	34	5,15	189,7	37,3	5,09
	20	129.2	26.9	4,80	135,6	27,8	4,88	152,6	30,4	5,02	159,2	31,6	5,04	174,4	34,8	5,01	188,8	38	4,97
	22	129.8	27.7	4,69	136,3	28,7	4,75	152,8	31,3	4,88	158,8	32,5	4,89	173	35,5	4,87	187,9	38,8	4,84
	25	130.7	29.0	4,51	137,1	30	4,57	152,1	32,6	4,67	157,6	33,8	4,66	170,9	36,6	4,67	186,7	40,1	4,66
26000 m³/h	10	128.3	22.1	5,81	134,5	22,8	5,90	150,1	25	6,00	156,4	25,9	6,04	173,1	28,3	6,12	190,1	31,1	6,11
	15	128.8	23.9	5,39	134,8	24,7	5,46	152	26,7	5,69	159,7	27,9	5,72	175,7	30,6	5,74	192,4	33,6	5,73
	18	129.0	25.0	5,16	135,1	25,9	5,22	152,8	28,1	5,44	160	29,2	5,48	176,9	32	5,53	192,5	34,9	5,52
	20	129.4	25.8	5,02	135,7	26,7	5,08	153,3	28,9	5,30	160,2	30	5,34	176,3	32,8	5,38	191,7	35,6	5,38
	22	129.9	26.6	4,88	136,2	27,5	4,95	153,8	29,8	5,16	160	30,9	5,18	175	33,4	5,24	191	36,4	5,25
	25	130.5	27.7	4,71	136,9	28,7	4,77	153,3	31	4,95	159	32	4,97	172,9	34,4	5,03	190	37,7	5,04
34000 m³/h	10	129.2	20.9	6,18	135,7	21,6	6,28	150,7	23,4	6,44	157,1	24,1	6,52	174,2	26,1	6,67	192,5	28,4	6,78
	15	129.4	22.6	5,73	135,5	23,3	5,82	152,9	25	6,12	160,6	25,9	6,20	177,3	28,3	6,27	195,4	30,8	6,34
	18	129.3	23.7	5,46	135,7	24,4	5,56	153,7	26,2	5,87	161	27,1	5,94	178,8	29,6	6,04	195,9	32	6,12
	20	129.8	24.4	5,32	136,3	25,1	5,43	154,2	27	5,71	161,3	28	5,76	178,4	30,3	5,89	195,5	32,7	5,98
	22	130.2	25.1	5,19	136,8	25,9	5,28	154,7	27,8	5,56	161,2	28,7	5,62	177,2	30,9	5,73	195	33,4	5,84
	25	130.9	26.2	5,00	137,4	27	5,09	154,3	28,9	5,34	160,3	29,8	5,38	175,4	31,9	5,50	194,3	34,5	5,63

kWf = Cooling capacity in kW
kWe = Compressor power input in kW
kWs = Sensible cooling capacity (kW)
kWt = Heating capacity (kW)
EER referred only to compressors

COP referred only to compressors
Ta = Indoor air temperature D.B/W.B.
DB = dry bulb
WB = wet bulb
The fan motor heating is not considered.

Integrated heating capacities

Air temperature external exchanger inlet °C (D.B. / W.B.)	-5 / -5.4	0 / -0.6	5 / 3.9	Others
Heating capacity multiplication coefficient	0,89	0,88	0,94	1

The integrated heating capacity represents the real heating capacity considering the defrost cycles too.

To obtain the integrated heating capacity multiply the heating performance value in kWt (shown in the heating performance tables) by the coefficients indicated in the table.

DB = dry bulb

WB = wet bulb

In case of below zero external air temperature with a long period of heat pump operating mode it is necessary to help the evacuation of the water produced during the defrost cycle; this to avoid the formation of ice in the unit basement. Pay attention that the evacuation will not create inconveniences to things or persons.

Size 54.4 CCKP configuration

Cooling performance with 30% of outdoor and exhaust air

Air flow	Ta (°C) D.B./ W.B.	Outdoor air temperature °C D.B./W.B.																							
		20 / 12				25 / 18				30 / 22				35 / 24				40 / 25				45 / 26			
		kWf	kWs	kWe	EER	kWf	kWs	kWe	EER	kWf	kWs	kWe	EER	kWf	kWs	kWe	EER	kWf	kWs	kWe	EER	kWf	kWs	kWe	EER
22000 m³/h	22 / 16	157,2	118,1	30,8	5,10	173,5	120,7	34,9	4,97	171,6	117,8	39,2	4,38	167,4	116,4	43,6	3,84	160,3	116,7	48,8	3,28	160,8	124,5	56,1	2,87
	24 / 17	161,1	121,2	31,1	5,18	175,8	124,3	35,1	5,01	175,3	121	39,5	4,44	170,5	120,4	43,9	3,88	161,5	121,6	49,1	3,29	162,6	131	57,3	2,84
	26 / 18	164,9	124,3	31,3	5,27	172,8	124,8	35,2	4,91	178,9	124,2	39,7	4,51	173,5	124,1	44,1	3,93	162	127,1	49,4	3,28	165,7	133,2	57,1	2,90
	27 / 19	168,3	124	31,5	5,34	173	122,9	35,4	4,89	179	122,1	39,9	4,49	176,8	123,6	44,4	3,98	165,5	126,6	49,7	3,33	169,1	132,4	57,2	2,96
	28 / 20	171,8	123,7	31,7	5,42	173,3	120,9	35,6	4,87	179,1	119,9	40,2	4,46	180,1	123,1	44,6	4,04	169,4	125,8	50	3,39	172,6	131,5	57,2	3,02
	30 / 22	179,1	122,9	32,2	5,56	180,8	118,9	36,2	4,99	179,7	115,4	40,7	4,42	186,2	122,5	45,2	4,12	177,1	124,4	50,6	3,50	-	-	-	--
29000 m³/h	22 / 16	168,8	128,9	31,7	5,32	184,5	132,7	35,6	5,18	183,1	128	39,9	4,59	176,3	128,9	44,3	3,98	167,6	132,1	49,5	3,39	171,8	141,7	57,1	3,01
	24 / 17	172,7	133,1	31,9	5,41	187,1	137,1	35,8	5,23	185,7	133,8	40,1	4,63	180,2	133,1	44,7	4,03	170,5	135,9	49,9	3,42	175,8	145	57,6	3,05
	26 / 18	176,5	137,4	32	5,52	184,6	137,4	36	5,13	188,1	139,4	40,3	4,67	182,9	138,5	44,9	4,07	173,4	139,3	50,4	3,44	187,1	151,9	59,1	3,17
	27 / 19	180,1	137,1	32,2	5,59	185,1	134,8	36,2	5,11	188,6	136,6	40,6	4,65	185,9	138,6	45,1	4,12	176,7	139,2	50,7	3,49	195,3	154,1	60,1	3,25
	28 / 20	183,9	136,8	32,4	5,68	185,7	132,2	36,5	5,09	189,1	133,8	40,9	4,62	188,9	138,5	45,3	4,17	180,1	139,3	51	3,53	203,7	156,3	61,1	3,33
	30 / 22	191,6	135,7	32,8	5,84	193,4	130,1	37	5,23	190,3	128	41,4	4,60	195,7	137,1	45,9	4,26	187,1	139,3	51,5	3,63	-	-	-	-
34000 m³/h	22 / 16	174,5	136,6	31,9	5,47	191,2	139,3	35,9	5,33	188,7	135,5	40,3	4,68	180,9	137,4	44,6	4,06	172,1	140,5	49,9	3,45	177,5	150,6	56,9	3,12
	24 / 17	178,2	141,7	32,1	5,55	194,3	143,5	36,2	5,37	191,3	141,4	40,6	4,71	184,7	142,5	44,9	4,11	174,8	145,9	50,2	3,48	180	157	57,5	3,13
	26 / 18	181,9	146,7	32,3	5,63	190,9	145,1	36,4	5,24	194,2	146,9	40,8	4,76	188,6	146,6	45,3	4,16	177,2	151	50,4	3,52	192	164,6	59,2	3,24
	27 / 19	185,9	146	32,5	5,72	191	142,8	36,6	5,22	194,7	143,9	41,1	4,74	192	145,9	45,6	4,21	180,4	151	50,8	3,55	200,4	167,1	60,2	3,33
	28 / 20	190	145,1	32,8	5,79	191,2	140,6	36,8	5,20	195,2	140,9	41,3	4,73	195,5	145,1	45,9	4,26	183,8	150,9	51,3	3,58	209,1	169,6	61,2	3,42
	30 / 22	198,5	142,9	33,3	5,96	199,1	138,1	37,4	5,32	196,2	135	41,9	4,68	201,9	144,3	46,5	4,34	190,6	150,5	52,2	3,65	-	-	-	-

Heating performance with 30% of outdoor and exhaust air

Airflow	Ta (°C) DB	Outdoor air temperature °C D.B./W.B.																	
		-7 / -8			-5 / -6			0 / -1			2 / 1			7 / 6			12 / 11		
		kWt	kWe	COP	kWt	kWe	COP	kWt	kWe	COP	kWt	kWe	COP	kWt	kWe	COP	kWt	kWe	COP
22000 m³/h	10	136,6	25,3	5,40	143,3	26,2	5,47	159,8	29	5,51	165,9	30,1	5,51	182,5	33,2	5,50	199,6	36,9	5,41
	15	136,8	27,3	5,01	143,1	28,2	5,07	162,1	31,1	5,21	169,3	32,5	5,21	184,8	36	5,13	201,2	40	5,03
	18	136,8	28,5	4,80	143,3	29,6	4,84	162,7	32,6	4,99	169,5	34	4,99	185,7	37,7	4,93	200,6	41,5	4,83
	20	137,3	29,5	4,65	144	30,6	4,71	163,1	33,6	4,85	169,6	35	4,85	184,7	38,6	4,78	199,3	42,3	4,71
	22	137,9	30,5	4,52	144,6	31,6	4,58	163,5	34,6	4,73	169,2	36	4,70	182,9	39,4	4,64	198	43	4,60
	25	138,7	31,9	4,35	145,5	33,2	4,38	162,7	36,2	4,49	167,7	37,5	4,47	180,3	40,6	4,44	196,6	44,6	4,41
29000 m³/h	10	136,6	23,5	5,81	143,1	24,3	5,89	159,9	26,6	6,01	166,6	27,5	6,06	184,5	30	6,15	202,9	33	6,15
	15	137,4	25,4	5,41	143,9	26,3	5,47	162,1	28,5	5,69	170,2	29,6	5,75	187,3	32,5	5,76	205,3	35,7	5,75
	18	137,8	26,6	5,18	144,5	27,5	5,25	162,9	29,9	5,45	170,6	31	5,50	188,6	34	5,55	205,5	37,1	5,54
	20	138,2	27,4	5,04	144,9	28,4	5,10	163,4	30,8	5,31	170,8	32	5,34	188	34,9	5,39	204,8	37,9	5,40
	22	138,6	28,3	4,90	145,4	29,2	4,98	164	31,7	5,17	170,7	32,9	5,19	186,6	35,7	5,23	204,1	38,7	5,27
	25	139,2	29,5	4,72	145,9	30,5	4,78	163,7	33,1	4,95	169,8	34,2	4,96	184,5	36,8	5,01	203,2	40,1	5,07
34000 m³/h	10	137,2	22,7	6,04	143,9	23,5	6,12	160,4	25,5	6,29	167	26,3	6,35	185	28,6	6,47	203,9	31,2	6,54
	15	137,8	24,6	5,60	144,4	25,4	5,69	162,7	27,2	5,98	170,7	28,3	6,03	188,2	31	6,07	207	33,8	6,12
	18	137,9	25,7	5,37	144,8	26,6	5,44	163,1	28,6	5,70	170,9	29,7	5,75	189,7	32,4	5,85	207,6	35,2	5,90
	20	138,5	26,5	5,23	145,4	27,4	5,31	163,4	29,5	5,54	171	30,6	5,59	189,3	33,2	5,70	207,2	35,9	5,77
	22	139,0	27,3	5,09	145,9	28,2	5,17	163,7	30,4	5,38	170,9	31,4	5,44	188,1	33,9	5,55	206,8	36,6	5,65
	25	139,8	28,5	4,91	146,6	29,5	4,97	163,6	31,7	5,16	170,2	32,6	5,22	186,3	34,9	5,34	206,1	38	5,42

kWf = Cooling capacity in kW
 kWe = Compressor power input in kW
 kWs = Sensible cooling capacity (kW)
 kWt = Heating capacity (kW)
 EER referred only to compressors
 COP referred only to compressors

Ta = Indoor air temperature D.B./W.B.
 DB = dry bulb
 WB = wet bulb
 The fan motor heating is not considered.

Integrated heating capacities

Air temperature external exchanger inlet °C (D.B. / W.B.)	-5 / -5.4	0 / -0.6	5 / 3.9	Others
Heating capacity multiplication coefficient	0,89	0,88	0,94	1

The integrated heating capacity represents the real heating capacity considering the defrost cycles too.

To obtain the integrated heating capacity multiply the heating performance value in kWt (shown in the heating performance tables) by the coefficients indicated in the table.

DB = dry bulb

WB = wet bulb

In case of below zero external air temperature with a long period of heat pump operating mode it is necessary to help the evacuation of the water produced during the defrost cycle; this to avoid the formation of ice in the unit basement. Pay attention that the evacuation will not create inconveniences to things or persons.

Size 60.4 CCKP configuration

Cooling performance with 30% of outdoor and exhaust air

Air flow	Ta (°C) D.B./W.B.	Outdoor air temperature °C D.B./W.B.																							
		20 / 12				25 / 18				30 / 22				35 / 24				40 / 25				45 / 26			
		kWf	kWs	kWe	EER	kWf	kWs	kWe	EER	kWf	kWs	kWe	EER	kWf	kWs	kWe	EER	kWf	kWs	kWe	EER	kWf	kWs	kWe	EER
29000 m ³ /h	22 / 16	190,1	142,8	34,8	5,46	209,4	147	39,3	5,33	210,1	141	44,2	4,75	202,6	142,7	48,8	4,15	193,3	143,3	54,5	3,55	190	154	61,6	3,08
	24 / 17	194,9	146,9	35,1	5,55	213,1	150,9	39,5	5,39	213	146,9	44,4	4,80	205,9	148,8	49	4,20	195,3	149,6	54,7	3,57	192,6	159	61,7	3,12
	26 / 18	199,3	151	35,3	5,65	209,3	152	39,7	5,27	215,8	152,9	44,7	4,83	209,1	154,3	49,3	4,24	197,1	156,2	54,8	3,60	197,8	162,5	62,4	3,17
	27 / 19	203,3	150,9	35,5	5,73	209,5	149,8	39,9	5,25	216,1	150,3	44,9	4,81	212,9	153,9	49,6	4,29	201	155,7	55,2	3,64	202,5	162,1	62,9	3,22
	28 / 20	207,6	150,6	35,7	5,82	209,7	147,6	40,2	5,22	216,4	147,8	45,2	4,79	216,8	153,4	49,9	4,34	205,2	154,9	55,6	3,69	207,4	161,6	63,5	3,27
	30 / 22	216,7	149,3	36	6,02	218,5	145,4	40,8	5,36	217	142,7	45,7	4,75	225,7	151,3	50,5	4,47	214	153	56,5	3,79	-	-	-	-
33000 m ³ /h	22 / 16	197,1	148,8	35,1	5,62	215,2	153,9	39,8	5,41	216	147,3	44,6	4,84	208,9	148,6	49,2	4,25	197,1	152,3	54,9	3,59	197,7	161,3	62,4	3,17
	24 / 17	201,6	153,8	35,3	5,71	218,9	158,4	40	5,47	218,9	154,6	44,7	4,90	213,3	154	49,6	4,30	199,8	157,6	55,3	3,61	198,4	168,3	62,2	3,19
	26 / 18	206,4	158,4	35,6	5,80	216,2	158,5	40,3	5,36	222,5	160,7	44,9	4,96	216,7	160,1	49,8	4,35	201,9	163	55,8	3,62	203,4	172,8	62,7	3,24
	27 / 19	211	157,7	35,8	5,89	217	155,5	40,5	5,36	223	157,7	45,2	4,93	220,2	160,2	50,1	4,40	205,8	162,9	56,2	3,66	208	172,7	63,2	3,29
	28 / 20	215,7	156,8	36	5,99	217,8	152,4	40,8	5,34	223,6	154,7	45,5	4,91	223,7	160,2	50,4	4,44	210	162,7	56,5	3,72	212,7	172,6	63,7	3,34
	30 / 22	225,6	154,8	36,5	6,18	226,2	151	41,4	5,46	225	148,3	46	4,89	231,4	159,5	51	4,54	218,5	162,3	57,1	3,83	-	-	-	-
47000 m ³ /h	22 / 16	212,5	168,9	35,9	5,92	231,1	175,5	40,5	5,71	228,7	170,9	45,4	5,04	222,3	170,1	50,1	4,44	207,3	178,5	55,9	3,71	202,8	188,6	62,6	3,24
	24 / 17	216,9	176,2	36,1	6,01	234,6	181,8	40,8	5,75	233,5	177,1	45,7	5,11	226,1	178,9	50,4	4,49	209,9	185,6	56,5	3,72	199	195,3	62,3	3,19
	26 / 18	221,5	182,9	36,3	6,10	231,7	182,2	41,1	5,64	238,6	182,9	46	5,19	229,9	186,1	50,7	4,53	212,3	192,3	57	3,72	204,3	199,1	62,5	3,27
	27 / 19	226,3	182	36,5	6,20	232,5	178,6	41,4	5,62	238,6	179,7	46,3	5,15	233,8	185,7	51	4,58	216,6	192	57,3	3,78	207,6	199	62,6	3,32
	28 / 20	231,1	181,1	36,7	6,30	233,3	174,9	41,7	5,59	238,7	176,5	46,6	5,12	237,7	185,2	51,3	4,63	221,2	191,8	57,6	3,84	210,8	198,7	62,8	3,36
	30 / 22	241	178,7	37,3	6,46	242	173,3	42,2	5,73	239	170	47,2	5,06	245,9	183,9	51,9	4,74	230,6	191	58,2	3,96	-	-	-	-

Heating performance with 30% of outdoor and exhaust air

Airflow	Ta (°C) DB	Outdoor air temperature °C D.B./W.B.																	
		-7 / -8			-5 / -6			0 / -1			2 / 1			7 / 6			12 / 11		
		kWt	kWe	COP	kWt	kWe	COP	kWt	kWe	COP	kWt	kWe	COP	kWt	kWe	COP	kWt	kWe	COP
29000 m ³ /h	10	159,5	27,8	5,74	167,8	28,8	5,83	186,3	31,6	5,90	193,7	33	5,87	213,9	36,5	5,86	234	40,2	5,82
	15	159,7	30,0	5,32	167,3	31,1	5,38	189	33,8	5,59	197,7	35,5	5,57	216,5	39,4	5,49	235,7	43,5	5,42
	18	159,6	31,4	5,08	167,5	32,6	5,14	189,4	35,5	5,34	197,6	37,1	5,33	217,4	41,1	5,29	235,2	45,1	5,22
	20	160,2	32,4	4,94	168,3	33,7	4,99	189,6	36,6	5,18	197,6	38,1	5,19	216,4	42,1	5,14	233,9	45,9	5,10
	22	160,9	33,4	4,82	169	34,8	4,86	189,9	37,6	5,05	197,1	39,2	5,03	214,4	42,9	5,00	232,6	46,7	4,98
	25	162,0	34,9	4,64	169,9	36,4	4,67	188,9	39,4	4,79	195,5	40,7	4,80	211,6	44,1	4,80	230,8	48,3	4,78
33000 m ³ /h	10	159,4	26,9	5,93	167,4	27,8	6,02	186,5	30,5	6,11	194,5	31,6	6,16	214,9	34,7	6,19	235,1	38,1	6,17
	15	159,7	29,0	5,51	167,1	29,9	5,59	189,9	32,7	5,81	198,8	34,1	5,83	217,9	37,5	5,81	238,5	41,4	5,76
	18	159,7	30,3	5,27	167,4	31,3	5,35	189,9	34,2	5,55	198,5	35,6	5,58	219,2	39,3	5,58	238,6	43	5,55
	20	160,3	31,2	5,14	168,1	32,3	5,20	189,9	35,2	5,39	198,3	36,6	5,42	218,3	40,3	5,42	237,3	43,9	5,41
	22	160,9	32,2	5,00	168,9	33,3	5,07	189,9	36,2	5,25	197,8	37,7	5,25	216,4	41,1	5,27	236,1	44,7	5,28
	25	161,9	33,6	4,82	169,8	34,9	4,87	189,7	37,9	5,01	196,7	39,2	5,02	213,6	42,4	5,04	234,4	46,2	5,07
47000 m ³ /h	10	160,8	24,9	6,46	169,1	25,7	6,58	187,4	27,9	6,72	195,3	28,7	6,80	216,4	30,9	7,00	239,2	33,5	7,14
	15	160,4	27,0	5,94	167,9	27,8	6,04	190,7	29,9	6,38	199,9	30,9	6,47	220,3	33,6	6,56	243,1	36,6	6,64
	18	159,9	28,2	5,67	167,8	29,1	5,77	191,4	31,4	6,10	200,5	32,5	6,17	222,3	35,3	6,30	243,9	38,1	6,40
	20	160,5	29,0	5,53	168,5	30	5,62	191,9	32,4	5,92	200,8	33,5	5,99	221,9	36,2	6,13	243,4	38,9	6,26
	22	161,2	29,9	5,39	169,2	30,8	5,49	192,4	33,4	5,76	200,6	34,4	5,83	220,5	36,9	5,98	242,9	39,7	6,12
	25	162,3	31,2	5,20	170,1	32,2	5,28	191,6	34,8	5,51	199,3	35,7	5,58	218,3	37,9	5,76	242,1	41,1	5,89

kWf = Cooling capacity in kW
 kWe = Compressor power input in kW
 kWs = Sensible cooling capacity (kW)
 kWt = Heating capacity (kW)
 EER referred only to compressors

COP referred only to compressors
 Ta = Indoor air temperature D.B./W.B.
 DB = dry bulb
 WB = wet bulb
 The fan motor heating is not considered.

Integrated heating capacities

Air temperature external exchanger inlet °C (D.B. / W.B.)	-5 / -5.4	0 / -0.6	5 / 3.9	Others
Heating capacity multiplication coefficient	0,89	0,88	0,94	1

The integrated heating capacity represents the real heating capacity considering the defrost cycles too.

To obtain the integrated heating capacity multiply the heating performance value in kWt (shown in the heating performance tables) by the coefficients indicated in the table.

DB = dry bulb

WB = wet bulb

In case of below zero external air temperature with a long period of heat pump operating mode it is necessary to help the evacuation of the water produced during the defrost cycle; this to avoid the formation of ice in the unit basement. Pay attention that the evacuation will not create inconveniences to things or persons.

Size 70.4 CCKP configuration

Cooling performance with 30% of outdoor and exhaust air

Air flow	Ta (°C) D.B./W.B.	Outdoor air temperature °C D.B./W.B.																							
		20 / 12				25 / 18				30 / 22				35 / 24				40 / 25				45 / 26			
		kWf	kWs	kWe	EER	kWf	kWs	kWe	EER	kWf	kWs	kWe	EER	kWf	kWs	kWe	EER	kWf	kWs	kWe	EER	kWf	kWs	kWe	EER
29000 m ³ /h	22 / 16	207,3	153,1	40,6	5,11	226,1	159,1	45,6	4,96	225,9	153,5	51	4,43	218,6	153,1	56,8	3,85	206,2	155,9	64,3	3,21	217,1	169,8	74,2	2,93
	24 / 17	211,4	158,2	40,9	5,17	230	163,2	45,9	5,01	230,4	158,1	51,4	4,48	222,6	158,8	57,1	3,90	209,8	161	64,6	3,25	227,3	174,8	75,7	3,00
	26 / 18	216	162,6	41,2	5,24	226,6	163,1	46,2	4,90	234,9	162,4	51,8	4,53	225,7	164,2	57,5	3,93	214	165,5	64,8	3,30	238,2	181,5	76,8	3,10
	27 / 19	220,4	162,6	41,5	5,31	227,1	160,3	46,6	4,87	235	159,7	52,2	4,50	229,2	164,2	57,9	3,96	218,5	164,9	65,3	3,35	247	182,9	77,7	3,18
	28 / 20	225	162,3	41,8	5,38	227,7	157,4	46,9	4,86	235,2	156,9	52,5	4,48	232,8	164,1	58,2	4,00	223,1	164,4	65,8	3,39	256,3	184,4	78,6	3,26
	30 / 22	234,9	161,1	42,4	5,54	237,2	155,6	47,6	4,98	235,8	151	53,3	4,42	241,9	162,4	59	4,10	232,6	163,3	66,9	3,48	-	-	-	-
37000 m ³ /h	22 / 16	219	168,9	41,4	5,29	240,9	172	46,5	5,18	237,4	168,7	51,9	4,57	229,8	167,1	57,8	3,98	219,4	170,2	65	3,38	233,4	192,1	75,7	3,08
	24 / 17	224,1	174,5	41,7	5,37	243,6	178,6	46,8	5,21	242,4	173,7	52,3	4,63	233,3	175,8	58	4,02	222,4	176,7	65,7	3,39	242,2	194,9	76,2	3,18
	26 / 18	229,1	180,3	42	5,45	240,3	178,8	47,2	5,09	247,5	178,2	52,8	4,69	237,8	181,1	58,5	4,06	225,2	183	66,2	3,40	253	204,4	77,4	3,27
	27 / 19	234,3	179,1	42,4	5,53	241,4	174,9	47,6	5,07	247,5	175,4	53,2	4,65	242,1	180,3	59	4,10	229,6	182,9	66,8	3,44	261,7	207,5	78,4	3,34
	28 / 20	239,6	178	42,8	5,60	242,6	171	48	5,05	247,5	172,5	53,6	4,62	246,4	179,4	59,4	4,15	234,2	182,9	67,4	3,47	270,5	210,3	79,2	3,42
	30 / 22	250,4	175,6	43,5	5,76	252,6	168,7	48,7	5,19	247,6	166,6	54,4	4,55	255,1	177,6	60,4	4,22	243,9	182,4	68,6	3,56	-	-	-	-
47000 m ³ /h	22 / 16	229,8	185,4	42,2	5,45	252,5	187,9	47,3	5,34	248,8	183	52,8	4,71	240,4	182,6	58,7	4,10	227,9	189,4	65,9	3,46	249,4	218	76,6	3,26
	24 / 17	236,3	190,6	42,5	5,56	255,8	195,4	47,6	5,37	252,9	190,2	53,2	4,75	244,9	190,7	59,1	4,14	232,1	196,6	66,2	3,51	264,4	227,2	78,2	3,38
	26 / 18	242,8	195,5	42,9	5,66	251,5	197	48	5,24	257,2	197,2	53,7	4,79	248,3	198,9	59,5	4,17	236,4	203,4	66,4	3,56	263,2	247,2	78,7	3,34
	27 / 19	247,8	194,9	43,3	5,72	252,1	193,3	48,4	5,21	257,7	193,4	54,1	4,76	252,4	198,5	59,9	4,21	241,2	203,1	67,1	3,59	263,2	256,6	79,1	3,33
	28 / 20	252,9	194,2	43,6	5,80	252,6	189,5	48,8	5,18	258,3	189,5	54,5	4,74	256,5	198,1	60,4	4,25	246,3	202,9	67,8	3,63	266,3	266,3	79,4	3,35
	30 / 22	263,2	192,7	44,2	5,95	264	185,5	49,5	5,33	259,8	181,2	55,3	4,70	265,2	197	61,3	4,33	257,2	202,1	69,4	3,71	-	-	-	-

Heating performance with 30% of outdoor and exhaust air

Airflow	Ta (°C) DB	Outdoor air temperature °C D.B./W.B.																	
		-7 / -8			-5 / -6			0 / -1			2 / 1			7 / 6			12 / 11		
		kWt	kWe	COP	kWt	kWe	COP	kWt	kWe	COP	kWt	kWe	COP	kWt	kWe	COP	kWt	kWe	COP
29000 m ³ /h	10	175,9	33,5	5,25	184,9	34,7	5,33	204,5	38,3	5,34	212,6	39,8	5,34	234,3	44,1	5,31	255,3	48,9	5,22
	15	176,0	36,1	4,88	184,6	37,4	4,94	207,2	41,1	5,04	216,8	42,9	5,05	236,8	47,6	4,97	257,2	52,7	4,88
	18	175,9	37,6	4,68	184,7	39,1	4,72	207,5	43	4,83	216,4	44,8	4,83	237,7	49,8	4,77	256,7	54,7	4,69
	20	176,4	38,8	4,55	185,2	40,3	4,60	207,8	44,3	4,69	216,2	46,1	4,69	236,5	51	4,64	255,4	55,8	4,58
	22	176,9	40,0	4,42	185,7	41,5	4,47	208	45,5	4,57	215,5	47,4	4,55	234,5	52,1	4,50	254,1	57	4,46
	25	177,7	41,8	4,25	186,3	43,4	4,29	206,8	47,6	4,34	213,9	49,4	4,33	231,4	53,7	4,31	252,1	59	4,27
37000 m ³ /h	10	177,2	31,6	5,61	185,8	32,6	5,70	206,1	35,5	5,81	214,9	36,8	5,84	237,6	40,3	5,90	260,1	44,5	5,84
	15	177,1	33,9	5,22	185,4	34,9	5,31	208,8	38	5,49	219,1	39,5	5,55	240,7	43,4	5,55	263,7	47,8	5,52
	18	176,8	35,2	5,02	185,4	36,4	5,09	209,2	39,7	5,27	218,9	41,2	5,31	242	45,2	5,35	264	49,5	5,33
	20	177,3	36,3	4,88	185,9	37,5	4,96	209,5	40,8	5,13	218,8	42,4	5,16	241,2	46,3	5,21	263,1	50,5	5,21
	22	177,8	37,4	4,75	186,4	38,5	4,84	209,8	42	5,00	218,3	43,5	5,02	239,4	47,2	5,07	262,2	51,4	5,10
	25	178,5	38,9	4,59	187	40,1	4,66	208,6	43,7	4,77	216,7	45,1	4,80	236,8	48,6	4,87	260,7	53,2	4,90
47000 m ³ /h	10	177,5	29,9	5,94	186,1	30,8	6,04	207,4	33,5	6,19	216,2	34,5	6,27	239,8	37,4	6,41	264,1	40,8	6,47
	15	177,4	32,2	5,51	185,4	33,2	5,58	209,2	35,5	5,89	220,6	36,9	5,98	243,7	40,3	6,05	267,5	44	6,08
	18	177,1	33,6	5,27	185,6	34,6	5,36	210,5	37,3	5,64	221,1	38,6	5,73	245,5	42,1	5,83	268	45,7	5,86
	20	177,7	34,6	5,14	186,5	35,7	5,22	211,3	38,4	5,50	221,4	39,8	5,56	244,7	43,1	5,68	267,3	46,7	5,72
	22	178,4	35,6	5,01	187,4	36,7	5,11	212,1	39,6	5,36	221	40,8	5,42	242,7	44	5,52	266,6	47,7	5,59
	25	179,4	37,1	4,84	188,5	38,3	4,92	211,1	41,1	5,14	219,3	42,3	5,18	239,8	45,3	5,29	265,7	49,3	5,39

kWf = Cooling capacity in kW
 kWe = Compressor power input in kW
 kWs = Sensible cooling capacity (kW)
 kWt = Heating capacity (kW)
 EER referred only to compressors

COP referred only to compressors
 Ta = Indoor air temperature D.B./W.B.
 DB = dry bulb
 WB = wet bulb
 The fan motor heating is not considered

Integrated heating capacities

Air temperature external exchanger inlet °C (D.B. / W.B.)	-5 / -5.4	0 / -0.6	5 / 3.9	Others
Heating capacity multiplication coefficient	0,89	0,88	0,94	1

The integrated heating capacity represents the real heating capacity considering the defrost cycles too.
 To obtain the integrated heating capacity multiply the heating performance value in kWt (shown in the heating performance tables) by the coefficients indicated in the table.
 DB = dry bulb
 WB = wet bulb
 In case of below zero external air temperature with a long period of heat pump operating mode it is necessary to help the evacuation of the water produced during the defrost cycle; this to avoid the formation of ice in the unit basement. Pay attention that the evacuation will not create inconveniences to things or persons.

Size 80.4 CCKP configuration

Cooling performance with 30% of outdoor and exhaust air

Air flow	Ta (°C) D.B./W.B.	Outdoor air temperature °C D.B./W.B.																							
		20 / 12				25 / 18				30 / 22				35 / 24				40 / 25				45 / 26			
		kWf	kWs	kWe	EER	kWf	kWs	kWe	EER	kWf	kWs	kWe	EER	kWf	kWs	kWe	EER	kWf	kWs	kWe	EER	kWf	kWs	kWe	EER
29000 m ³ /h	22 / 16	221,2	164,8	44,2	5,00	245	169,9	49,7	4,93	247,6	163,1	55,9	4,43	239,3	163,1	62,3	3,84	225,4	164,1	70,9	3,18	225	172,4	77,3	2,91
	24 / 17	227,7	168,3	44,5	5,12	248,5	174,6	49,9	4,98	252,1	167,8	56,3	4,48	242,6	170,5	62,3	3,89	230,5	167,4	71,3	3,23	227,2	177,4	77,7	2,92
	26 / 18	233,7	172	44,7	5,23	244,6	174,4	50,2	4,87	256,8	172,1	56,7	4,53	248,3	174,2	62,7	3,96	235,7	170,1	71,7	3,29	232,2	180,8	78,4	2,96
	27 / 19	238,5	172	45	5,30	245	171,8	50,5	4,85	257,4	169,2	57	4,52	253,6	173,1	63,1	4,02	239,8	170	72,2	3,32	237,2	179,6	79	3,00
	28 / 20	243,3	172	45,2	5,38	245,6	169,1	50,8	4,83	258,1	166,3	57,3	4,50	258,9	172,1	63,4	4,08	243,8	170,2	72,7	3,35	242,3	178,4	79,6	3,04
	30 / 22	253,2	171,6	45,8	5,53	257,5	166,4	51,5	5,00	259,4	160,6	57,9	4,48	268,9	170,6	64,3	4,18	252,1	170,3	73,7	3,42	-	-	-	-
44000 m ³ /h	22 / 16	248,7	190,7	45,7	5,44	274,7	195,1	51,2	5,37	272,7	189,9	57,4	4,75	263,7	189	64	4,12	245,4	193,6	72,9	3,37	251,5	205,1	80,1	3,14
	24 / 17	254,4	197,3	46	5,53	278,4	202	51,5	5,41	277,8	196,5	57,9	4,80	268,4	197,2	64,3	4,17	250	200,3	73,1	3,42	253,6	213,5	80,3	3,16
	26 / 18	260,2	203,6	46,2	5,63	274,1	203	51,8	5,29	282,4	203,2	58,3	4,84	274,2	203,1	64,7	4,24	254,3	207,1	73,3	3,47	261,1	219,4	81,4	3,21
	27 / 19	266,5	202,2	46,6	5,72	275,1	199,2	52,1	5,28	283,4	199,2	58,6	4,84	279,5	202,4	65,1	4,29	259,2	207,1	73,7	3,52	267,8	219,8	82,3	3,25
	28 / 20	272,9	200,5	47	5,81	276,1	195,4	52,5	5,26	284,3	195,3	59	4,82	284,7	201,6	65,4	4,35	264,3	207	74,1	3,57	274,6	220	83,2	3,30
	30 / 22	286,5	196,4	47,9	5,98	288,2	191,9	53,4	5,40	286	187,6	59,7	4,79	294,3	200,2	66,3	4,44	275	206,5	75	3,67	-	-	-	-
47000 m ³ /h	22 / 16	253,4	194,7	45,8	5,53	279,3	199	51,5	5,42	275,2	196,3	57,5	4,79	266	195,6	64,1	4,15	251,1	196,4	72,9	3,44	255,8	212,6	80,5	3,18
	24 / 17	258,8	201,8	46,1	5,61	283,7	205,1	51,9	5,47	281,6	201,5	58	4,86	271,3	203,7	64,4	4,21	253,9	205,7	73,2	3,47	258	220,1	80,7	3,20
	26 / 18	264,5	208,4	46,5	5,69	279,1	206,3	52,3	5,34	287,4	207,1	58,5	4,91	276,6	210,5	64,7	4,28	255,9	215,6	73,3	3,49	263	226,6	81,4	3,23
	27 / 19	270,8	207	46,8	5,79	279,8	202,5	52,6	5,32	287,8	203,8	58,8	4,89	281,6	210,1	65,1	4,33	261,4	214,8	73,8	3,54	268	227,2	82	3,27
	28 / 20	277,2	205,4	47,2	5,87	280,5	198,8	53	5,29	288,3	200,4	59,1	4,88	286,7	209,6	65,4	4,38	267,3	213,6	74,3	3,60	273,1	227,8	82,5	3,31
	30 / 22	290,3	201,8	48,1	6,04	291,8	196,4	53,8	5,42	289,5	193,4	59,7	4,85	296,5	208	66,3	4,47	279,1	211,3	75,3	3,71	-	-	-	-

Heating performance with 30% of outdoor and exhaust air

Airflow	Ta (°C) DB	Outdoor air temperature °C D.B./W.B.																	
		-7 / -8			-5 / -6			0 / -1			2 / 1			7 / 6			12 / 11		
		kWt	kWe	COP	kWt	kWe	COP	kWt	kWe	COP	kWt	kWe	COP	kWt	kWe	COP	kWt	kWe	COP
29000 m ³ /h	10	203,6	40,3	5,05	213,7	42	5,09	236,2	46,8	5,05	245,1	49	5,00	268	54,7	4,90	288,8	60,7	4,76
	15	203,8	43,5	4,69	213,3	45,2	4,72	239,2	50,2	4,76	249,5	52,7	4,73	269,9	58,7	4,60	289,5	65,1	4,45
	18	203,6	45,4	4,48	213,6	47,3	4,52	239,6	52,5	4,56	249,1	54,9	4,54	270,5	61	4,43	288,7	67,4	4,28
	20	204,4	46,9	4,36	214,4	48,8	4,39	239,8	54,1	4,43	248,8	56,4	4,41	268,8	62,4	4,31	287,3	68,7	4,18
	22	205,3	48,4	4,24	215,2	50,2	4,29	240,1	55,7	4,31	247,8	57,9	4,28	266	63,6	4,18	286	70,1	4,08
	25	206,6	50,6	4,08	216	52,5	4,11	238,3	57,8	4,12	245,2	60	4,09	261,8	65,5	4,00	285,4	70,4	4,05
44000 m ³ /h	10	204,9	35,8	5,72	215,5	37	5,82	239,2	40,6	5,89	249,1	42	5,93	274,5	45,9	5,98	300,7	50,6	5,94
	15	205,2	38,5	5,33	215,1	39,8	5,40	243	43,5	5,59	254,3	45,2	5,63	278,3	49,5	5,62	305,2	54,4	5,61
	18	205,0	40,1	5,11	215,3	41,5	5,19	243,8	45,5	5,36	254,4	47,3	5,38	280,1	51,8	5,41	305,3	56,3	5,42
	20	205,8	41,4	4,97	216,1	42,8	5,05	244,4	46,9	5,21	254,5	48,7	5,23	279,1	53	5,27	303,7	57,4	5,29
	22	206,7	42,6	4,85	217	44,1	4,92	244,9	48,2	5,08	253,9	50	5,08	277	53,9	5,14	302,2	58,4	5,17
	25	207,9	44,5	4,67	218	46,1	4,73	243,5	50,1	4,86	252	51,6	4,88	273,9	55,4	4,94	300,2	60,4	4,97
47000 m ³ /h	10	205,2	35,2	5,83	215,9	36,4	5,93	239,2	39,8	6,01	249,1	41,1	6,06	275,5	44,9	6,14	302,3	49,4	6,12
	15	205,4	37,9	5,42	215,2	39,2	5,49	242,3	42,3	5,73	254,4	44,1	5,77	279,3	48,5	5,76	305,9	53,1	5,76
	18	205,1	39,6	5,18	215,4	40,9	5,27	242,9	44,4	5,47	254,4	46,3	5,49	280,9	50,7	5,54	305,9	55,1	5,55
	20	206,0	40,8	5,05	216,3	42,2	5,13	243,3	45,8	5,31	254,5	47,7	5,34	280	51,9	5,39	304,7	56,1	5,43
	22	206,9	42,0	4,93	217,2	43,5	4,99	243,8	47,2	5,17	254	49	5,18	277,9	52,9	5,25	303,5	57,2	5,31
	25	208,2	43,9	4,74	218,4	45,4	4,81	243,1	49,1	4,95	252,5	50,7	4,98	274,8	54,5	5,04	301,8	59,1	5,11

kWf = Cooling capacity in kW
kWe = Compressor power input in kW
kWs = Sensible cooling capacity (kW)
kWt = Heating capacity (kW)
EER referred only to compressors

COP referred only to compressors
Ta = Indoor air temperature D.B./W.B.
DB = dry bulb
WB = wet bulb
The fan motor heating is not considered.

Integrated heating capacities

Air temperature external exchanger inlet °C (D.B. / W.B.)	-5 / -5.4	0 / -0.6	5 / 3.9	Others
Heating capacity multiplication coefficient	0,89	0,88	0,94	1

The integrated heating capacity represents the real heating capacity considering the defrost cycles too.

To obtain the integrated heating capacity multiply the heating performance value in kWt (shown in the heating performance tables) by the coefficients indicated in the table.

DB = dry bulb

WB = wet bulb

In case of below zero external air temperature with a long period of heat pump operating mode it is necessary to help the evacuation of the water produced during the defrost cycle; this to avoid the formation of ice in the unit basement. Pay attention that the evacuation will not create inconveniences to things or persons.

Size 90.4 CCKP configuration

Cooling performance with 30% of outdoor and exhaust air

Air flow	Ta (°C) D.B./W.B.	Outdoor air temperature °C D.B./W.B.																							
		20 / 12				25 / 18				30 / 22				35 / 24				40 / 25				45 / 26			
		kWf	kWs	kWe	EER	kWf	kWs	kWe	EER	kWf	kWs	kWe	EER	kWf	kWs	kWe	EER	kWf	kWs	kWe	EER	kWf	kWs	kWe	EER
38000 m ³ /h	22 / 16	276,7	202,5	52,6	5,26	303,8	210,6	59,2	5,13	304,6	206,9	65,6	4,64	298,6	204,7	73,1	4,08	286,4	205,5	81,8	3,50	281,1	213,2	91,7	3,07
	24 / 17	281,6	209,9	52,9	5,32	308,7	216,3	59,5	5,19	309,4	213,6	66	4,69	303,5	212,5	73,5	4,13	289,9	212,2	82,4	3,52	284,2	219,9	92,2	3,08
	26 / 18	286,4	217,2	53,2	5,38	303,7	216,5	59,9	5,07	313,7	220,9	66,5	4,72	306,7	220,7	73,8	4,16	292,9	219,2	82,9	3,53	287,2	227,1	92,9	3,09
	27 / 19	293,7	215,8	53,6	5,48	304,6	212,8	60,2	5,06	315,2	216,4	66,9	4,71	311,5	220,9	74,3	4,19	297,8	219,6	83,3	3,58	291,7	227	93,6	3,12
	28 / 20	301,2	214,4	54	5,58	305,6	209,1	60,7	5,03	316,7	212	67,4	4,70	316,4	221	74,7	4,24	303,1	220	83,7	3,62	296,3	226,8	94,3	3,14
	30 / 22	316,3	211,4	54,9	5,76	319,3	206,3	61,6	5,18	320	203	68,3	4,69	330	217,7	75,8	4,35	314	220,4	84,5	3,72	-	-	-	-
51000 m ³ /h	22 / 16	297,7	227,6	53,8	5,53	327,6	233,9	60,5	5,41	328,1	227,4	67,3	4,88	317,8	228,5	74,8	4,25	303,4	232,6	83,1	3,65	299,1	245,6	93,7	3,19
	24 / 17	305,8	233,9	54,2	5,64	333,2	240,7	60,8	5,48	334	235,8	67,7	4,93	324,5	236,4	75,4	4,30	308,8	240	83,6	3,69	300,2	256,2	94,2	3,19
	26 / 18	313,7	240,3	54,5	5,76	328,9	240,7	61,4	5,36	339,8	243,7	68,2	4,98	329,8	245,2	75,8	4,35	313,6	248	84	3,73	308,5	261,1	95,7	3,22
	27 / 19	319,9	240,4	54,9	5,83	330,1	236	61,9	5,33	340,1	240,2	68,6	4,96	335,3	245,1	76,3	4,39	319,1	248,1	84,6	3,77	316	260,1	96,9	3,26
	28 / 20	326,2	240,3	55,3	5,90	331,2	231,3	62,4	5,31	340,5	236,5	69	4,93	340,9	244,8	76,8	4,44	324,8	248,2	85,1	3,82	323,7	259	98,1	3,30
	30 / 22	339,2	239,5	56	6,06	344,7	228,8	63,3	5,45	341,9	228,4	69,8	4,90	352,4	243,5	77,9	4,52	336,4	248,2	86,3	3,90	-	-	-	-
60000 m ³ /h	22 / 16	309,6	240,6	54,5	5,68	338,8	248,2	61,2	5,54	338,8	241,1	68	4,98	327,8	243,3	75,4	4,35	309,9	251,5	84	3,69	310,6	263,5	95,2	3,26
	24 / 17	316,2	250,3	54,7	5,78	344	256,4	61,7	5,58	344,8	251,4	68,4	5,04	332,5	255,6	75,8	4,39	314,4	260,6	84,5	3,72	316,3	269,5	96,4	3,28
	26 / 18	322,8	259,7	55	5,87	338,6	258,4	62,1	5,45	351,5	260,2	68,8	5,11	338,7	264,5	76,4	4,43	319,1	269,4	85	3,75	339,8	284,7	100	3,40
	27 / 19	330,4	257,9	55,5	5,95	339,5	253,9	62,5	5,43	352,2	255,3	69,3	5,08	345	263,1	76,9	4,49	325,1	269,4	85,4	3,81	356,7	290,4	102,5	3,48
	28 / 20	338,1	256,2	55,9	6,05	340,4	249,3	62,9	5,41	353,1	250,3	69,8	5,06	351,4	261,7	77,5	4,53	331,5	269,4	85,9	3,86	374,3	296,2	105,1	3,56
	30 / 22	353,4	252,7	56,8	6,22	356	244,6	63,9	5,57	355	240,1	70,9	5,01	363,6	260	78,6	4,63	344,4	269,1	86,9	3,96	-	-	-	-

Heating performance with 30% of outdoor and exhaust air

Airflow	Ta (°C) DB	Outdoor air temperature °C D.B./W.B.																	
		-7 / -8			-5 / -6			0 / -1			2 / 1			7 / 6			12 / 11		
		kWt	kWe	COP	kWt	kWe	COP	kWt	kWe	COP	kWt	kWe	COP	kWt	kWe	COP	kWt	kWe	COP
38000 m ³ /h	10	238,7	44,8	5,33	250,7	46,5	5,39	278	52,1	5,34	290,1	54,5	5,32	319,7	60,8	5,26	346,9	67,6	5,13
	15	239,9	48,8	4,92	251,4	50,6	4,97	282,2	56,1	5,03	295,7	58,8	5,03	322,6	65,3	4,94	348,5	72,4	4,81
	18	240,3	51,2	4,69	252,1	53,2	4,74	282,8	58,8	4,81	295,5	61,4	4,81	323,6	67,9	4,77	347,8	74,9	4,64
	20	241,3	52,9	4,56	253	54,9	4,61	283,2	60,7	4,67	295,4	63,2	4,67	322	69,5	4,63	346,2	76,4	4,53
	22	242,2	54,6	4,44	253,9	56,6	4,49	283,6	62,5	4,54	294,7	64,9	4,54	319,1	71	4,49	344,7	77,8	4,43
	25	243,6	57,2	4,26	255	59,3	4,30	282,7	65,3	4,33	292,5	67,5	4,33	314,8	73,1	4,31	343	80,8	4,25
51000 m ³ /h	10	239,2	41,0	5,83	251,2	42,6	5,90	282,2	47,2	5,98	294,2	49	6,00	324,9	53,7	6,05	356,5	59,3	6,01
	15	239,9	44,6	5,38	251,3	46,2	5,44	286,5	50,7	5,65	300	52,8	5,68	329,2	58,2	5,66	360,2	64,3	5,60
	18	240,0	46,7	5,14	251,9	48,4	5,20	286,4	53,2	5,38	299,7	55,4	5,41	331	61,1	5,42	360,4	66,6	5,41
	20	241,0	48,3	4,99	252,9	49,9	5,07	286,4	54,9	5,22	299,4	57,2	5,23	329,9	62,5	5,28	359,3	67,7	5,31
	22	242,1	49,8	4,86	253,9	51,5	4,93	286,3	56,6	5,06	298,8	58,7	5,09	327,5	63,6	5,15	358,1	68,8	5,20
	25	243,6	52,1	4,68	255,2	53,8	4,74	285,8	58,9	4,85	297,2	60,7	4,90	323,8	65,2	4,97	356,1	71,1	5,01
60000 m ³ /h	10	240,4	39,4	6,10	253,1	41	6,17	282,5	45	6,28	294,1	46,6	6,31	326	51	6,39	359,9	55,8	6,45
	15	241,0	42,9	5,62	252,8	44,5	5,68	286,6	48,1	5,96	300,4	50,2	5,98	330,5	55,2	5,99	364,2	60,2	6,05
	18	241,1	45,0	5,36	253,1	46,7	5,42	287,5	50,4	5,70	300,6	52,6	5,71	332,4	57,7	5,76	364,8	62,5	5,84
	20	242,0	46,5	5,20	254,1	48,2	5,27	288,1	52	5,54	300,7	54,2	5,55	331,7	59,1	5,61	363,9	63,9	5,69
	22	243,0	48,1	5,05	255	49,8	5,12	288,7	53,5	5,40	300,3	55,6	5,40	329,9	60,3	5,47	363	65,2	5,57
	25	244,4	50,3	4,86	256,1	52,1	4,92	287,4	55,7	5,16	298,8	57,7	5,18	327,3	62,1	5,27	361,5	67,5	5,36

Wf = Cooling capacity in kW
 kWe = Compressor power input in kW
 kWs = Sensible cooling capacity (kW)
 kWt = Heating capacity (kW)
 EER referred only to compressors

COP referred only to compressors
 Ta = Indoor air temperature D.B./W.B.
 DB = dry bulb
 WB = wet bulb
 The fan motor heating is not considered.

Integrated heating capacities

Air temperature external exchanger inlet °C (D.B. / W.B.)	-5 / -5.4	0 / -0.6	5 / 3.9	Others
Heating capacity multiplication coefficient	0,89	0,88	0,94	1

The integrated heating capacity represents the real heating capacity considering the defrost cycles too.

To obtain the integrated heating capacity multiply the heating performance value in kWt (shown in the heating performance tables) by the coefficients indicated in the table.

DB = dry bulb

WB = wet bulb

In case of below zero external air temperature with a long period of heat pump operating mode it is necessary to help the evacuation of the water produced during the defrost cycle; this to avoid the formation of ice in the unit basement. Pay attention that the evacuation will not create inconveniences to things or persons.

Size 100.4 CCKP configuration

Cooling performance with 30% of outdoor and exhaust air

Air flow	Ta (°C) D.B./W.B.	Outdoor air temperature °C.D.B/W.B.																							
		20 / 12				25 / 18				30 / 22				35 / 24				40 / 25				45 / 26			
		kWf	kWs	kWe	EER	kWf	kWs	kWe	EER	kWf	kWs	kWe	EER	kWf	kWs	kWe	EER	kWf	kWs	kWe	EER	kWf	kWs	kWe	EER
38000 m ³ /h	22 / 16	281,9	210,6	57,8	4,88	312,9	217	64,8	4,83	312,3	212,1	72,6	4,30	306,3	209,2	81,2	3,77	295,8	209,3	90,9	3,25	292,5	218,3	102,1	2,86
	24 / 17	289,9	215,3	58,3	4,97	316,9	223,4	65,1	4,87	317,2	218,6	73,1	4,34	311,7	216,5	81,6	3,82	299,7	215,5	91,4	3,28	294,3	226,1	102,6	2,87
	26 / 18	297,5	220	58,7	5,07	312,4	222,4	65,7	4,75	321,3	225,9	73,6	4,37	316,5	223,8	81,9	3,86	302,9	222,1	91,8	3,30	298,5	232,5	103,5	2,88
	27 / 19	304,7	219,1	59,2	5,15	313,9	218,2	66,2	4,74	322,7	221,7	74,1	4,35	322,2	223,7	82,3	3,91	308,5	221,9	92,4	3,34	303,9	231,8	104,4	2,91
	28 / 20	311,9	218,3	59,6	5,23	315,5	214	66,7	4,73	324,2	217,5	74,6	4,35	327,9	223,5	82,7	3,96	314,4	221,7	93,1	3,38	309,5	231	105,3	2,94
	30 / 22	326,4	216,8	60,5	5,40	328,8	212,2	67,6	4,86	327,1	209	75,6	4,33	341	221	84	4,06	326,4	221,2	94,5	3,45	-	-	-	-
56000 m ³ /h	22 / 16	315,8	241,2	59,9	5,27	348,8	246	67,2	5,19	349,1	236,6	75,2	4,64	334,4	242,4	83,3	4,01	316,2	250,9	92,9	3,40	317,2	264,2	105,5	3,01
	24 / 17	322,6	249,7	60,3	5,35	355,4	252,1	67,7	5,25	354,2	246,6	75,8	4,67	341,5	251,3	83,8	4,08	322,2	257,1	93,8	3,43	323,9	272,2	107,1	3,02
	26 / 18	329,3	258,2	60,7	5,43	349,7	253,6	68,2	5,13	359,4	256	76,3	4,71	349,1	258	84,5	4,13	328,1	263,1	94,8	3,46	335,2	280,5	109	3,08
	27 / 19	337	257,2	61,1	5,52	350,1	249,8	68,6	5,10	360,3	251,5	76,8	4,69	356	256,5	85,1	4,18	334,4	263	95,4	3,51	343,9	282	110,4	3,12
	28 / 20	344,9	255,9	61,6	5,60	350,6	245,9	69,1	5,07	361,4	246,8	77,3	4,68	363	254,8	85,8	4,23	340,8	263,2	96	3,55	353	283,4	111,9	3,15
	30 / 22	361,2	252,7	62,6	5,77	364,3	243,7	70,2	5,19	363,9	237	78,3	4,65	375,6	253,4	87	4,32	353,9	263,4	97,1	3,64	-	-	-	-
60000 m ³ /h	22 / 16	320,2	248,6	60,1	5,33	352,5	253,7	67,5	5,22	351	246,7	75,3	4,66	340,8	245,5	83,9	4,06	320,7	255,7	93,8	3,42	322,9	274,6	106,7	3,03
	24 / 17	327,5	257,1	60,5	5,41	357,7	262,6	67,8	5,28	357,5	255,4	75,9	4,71	346,3	256,4	84,5	4,10	327,6	262,8	94,4	3,47	332,4	281	108,6	3,06
	26 / 18	335	265	61	5,49	353,6	262,5	68,4	5,17	363,6	264,2	76,5	4,75	352,1	266,7	84,9	4,15	334,5	269,4	95	3,52	343,2	288,9	110,1	3,12
	27 / 19	343	263,6	61,5	5,58	355,4	256,9	68,9	5,16	364,5	259,4	77	4,73	358,1	266,8	85,4	4,19	340,9	269,2	95,6	3,57	351,7	290,2	111,2	3,16
	28 / 20	351,2	262	62	5,66	357,1	251,5	69,4	5,15	365,4	254,7	77,6	4,71	364,2	266,8	85,8	4,24	347,2	269,3	96,3	3,61	360,3	291,5	112,4	3,21
	30 / 22	367,8	258,4	63	5,84	371,5	248,7	70,5	5,27	367,1	245,4	78,6	4,67	378,7	263	87,2	4,34	360,1	269,3	97,7	3,69	-	-	-	-

Heating performance with 30% of outdoor and exhaust air

Airflow	Ta (°C) DB	Outdoor air temperature °C.D.B/W.B.																	
		-7 / -8			-5 / -6			0 / -1			2 / 1			7 / 6			12 / 11		
		kWt	kWe	COP	kWt	kWe	COP	kWt	kWe	COP	kWt	kWe	COP	kWt	kWe	COP	kWt	kWe	COP
38000 m ³ /h	10	254.8	50.3	5,07	267,7	52,2	5,13	298,4	58,6	5,09	309,7	61	5,08	339,6	67,7	5,02	369,8	75,6	4,89
	15	255.8	54.6	4,68	268,1	56,8	4,72	302,2	62,8	4,81	315,2	65,7	4,80	343,4	73	4,70	371,2	81,2	4,57
	18	256.2	57.3	4,47	268,7	59,6	4,51	303,4	66	4,60	315,7	68,8	4,59	345,2	76,2	4,53	370,4	84,3	4,39
	20	257.1	59.3	4,34	269,5	61,7	4,37	304,2	68,2	4,46	316,1	70,9	4,46	343,4	78	4,40	368,9	86,2	4,28
	22	258.1	61.2	4,22	270,3	63,7	4,24	304,9	70,3	4,34	315,3	72,8	4,33	340,2	79,7	4,27	367,3	88	4,17
	25	259.5	64.2	4,04	271,4	66,8	4,06	303,1	73,2	4,14	312,3	75,6	4,13	335,3	82,2	4,08	366,7	90,2	4,07
56000 m ³ /h	10	256.8	44.8	5,73	269,9	46,4	5,82	301,3	51	5,91	313,7	52,9	5,93	347,4	57,8	6,01	381,3	63,6	6,00
	15	257.4	48.7	5,29	270,1	50,4	5,36	304,3	54,6	5,57	319,7	56,9	5,62	352,1	62,7	5,62	386	69,1	5,59
	18	257.5	51.0	5,05	270,5	52,8	5,12	305,4	57,4	5,32	319,9	59,7	5,36	354,1	65,8	5,38	386,6	71,6	5,40
	20	258.4	52.7	4,90	271,3	54,5	4,98	306,2	59,3	5,16	320	61,6	5,19	353	67,3	5,25	385,7	72,8	5,30
	22	259.2	54.4	4,76	272,1	56,3	4,83	306,9	61,1	5,02	319,6	63,3	5,05	350,5	68,4	5,12	384,7	74,1	5,19
	25	260.5	57.0	4,57	273	58,8	4,64	306,4	63,5	4,83	318	65,4	4,86	346,8	70	4,95	383,1	76,5	5,01
60000 m ³ /h	10	214.5	44.7	4,80	226,3	46,5	4,87	258,7	50,9	5,08	274,3	53	5,18	313,2	58,2	5,38	355,2	64	5,55
	15	213.5	48.3	4,42	225,3	50,1	4,50	257,7	54,5	4,73	272,9	56,7	4,81	310,2	62,4	4,97	351	68,5	5,12
	18	213.0	50.4	4,23	224,7	52,3	4,30	257,2	56,8	4,53	271,9	59,2	4,59	308,3	65	4,74	348,3	71,3	4,88
	20	212.7	51.9	4,10	224,3	53,8	4,17	256,8	58,4	4,40	271,2	60,8	4,46	307,1	66,8	4,60	346,3	73,4	4,72
	22	212.5	53.4	3,98	223,8	55,3	4,05	256,5	59,9	4,28	270,6	62,5	4,33	305,9	68,7	4,45	344,4	75,4	4,57
	25	212.2	55.7	3,81	223,2	57,6	3,88	255,9	62,7	4,08	269,7	65,2	4,14	304,2	71,5	4,25	341,3	78,5	4,35

kWf = Cooling capacity in kW
kWe = Compressor power input in kW
kWs = Sensible cooling capacity (kW)
kWt = Heating capacity (kW)
EER referred only to compressors

COP referred only to compressors
Ta = Indoor air temperature D.B./W.B.
DB = dry bulb
WB = wet bulb
The fan motor heating is not considered.

Integrated heating capacities

Air temperature external exchanger inlet °C (D.B. / W.B.)	-5 / -5.4	0 / -0.6	5 / 3.9	Others
Heating capacity multiplication coefficient	0,89	0,88	0,94	1

The integrated heating capacity represents the real heating capacity considering the defrost cycles too.

To obtain the integrated heating capacity multiply the heating performance value in kWt (shown in the heating performance tables) by the coefficients indicated in the table.

DB = dry bulb

WB = wet bulb

In case of below zero external air temperature with a long period of heat pump operating mode it is necessary to help the evacuation of the water produced during the defrost cycle; this to avoid the formation of ice in the unit basement. Pay attention that the evacuation will not create inconveniences to things or persons.

Size 110.4 CCKP configuration

Cooling performance with 30% of outdoor and exhaust air

Air flow	Ta (°C) D.B./W.B.	Outdoor air temperature °C.D.B./W.B.																							
		20 / 12				25 / 18				30 / 22				35 / 24				40 / 25				45 / 26			
		kWf	kWs	kWe	EER	kWf	kWs	kWe	EER	kWf	kWs	kWe	EER	kWf	kWs	kWe	EER	kWf	kWs	kWe	EER	kWf	kWs	kWe	EER
38000 m ³ /h	22 / 16	296,1	218,4	64,3	4,60	327,5	225,6	72,1	4,54	326,1	221,2	80,8	4,04	321,7	216,2	90,1	3,57	309,4	216	101,1	3,06	308,1	226,8	113,2	2,72
	24 / 17	303,9	223,2	64,8	4,69	331,4	232,3	72,4	4,58	334,8	224,8	81,5	4,11	326,7	224,2	90,6	3,61	310,4	225	101,5	3,06	313,6	231,1	114,3	2,74
	26 / 18	312,3	227,2	65,5	4,77	326,7	231,2	73	4,48	343	228,6	82,2	4,17	332,5	230,2	91,1	3,65	312,1	233,2	102,1	3,06	317,6	239,9	115,7	2,75
	27 / 19	318,8	227,2	65,9	4,84	328	226,9	73,6	4,46	343,1	225,4	82,6	4,15	338,8	229,7	91,7	3,69	318,5	232,6	102,7	3,10	322,9	241,1	116,9	2,76
	28 / 20	325,6	226,9	66,4	4,90	329,5	222,6	74,2	4,44	343,4	222,1	83,1	4,13	345,1	229	92,2	3,74	325,8	231,5	103,3	3,15	328,3	242,3	118,1	2,78
	30 / 22	340,2	225,7	67,4	5,05	343,9	220,3	75,2	4,57	344,4	215,1	84,1	4,10	358,6	226,6	93,5	3,84	340,8	229,1	104,7	3,26	-	-	-	-
60000 m ³ /h	22 / 16	336,8	258,2	67,1	5,02	370,9	264,4	75,1	4,94	369	256,2	83,9	4,40	357,5	254,8	93,3	3,83	338,4	262,5	104,3	3,24	348,1	280,9	112	3,11
	24 / 17	344,4	266,3	67,7	5,09	377,7	270,8	75,8	4,98	376,9	263,7	84,6	4,46	365,1	263,5	94	3,88	342,6	272,7	104,9	3,27	351,4	293,6	106	3,32
	26 / 18	352,1	274	68,3	5,16	372,9	270,5	76,4	4,88	383,2	272,7	85,2	4,50	370,2	273,7	94,7	3,91	346,4	282,9	105,5	3,28	357,4	298,6	107,3	3,33
	27 / 19	360,7	272,3	68,8	5,24	374,2	265,2	77	4,86	383,8	267,7	85,8	4,47	376,2	273,6	95,3	3,95	353,8	281,8	106,3	3,33	363,6	297	107,8	3,37
	28 / 20	369,5	270,5	69,4	5,32	375,7	259,9	77,6	4,84	384,4	262,7	86,5	4,44	382,3	273,2	96	3,98	361,7	280,5	107,2	3,37	370	295	108,3	3,42
	30 / 22	387,7	266,2	70,5	5,50	391,4	256,2	78,9	4,96	385,6	252,8	87,8	4,39	397	270,4	97,3	4,08	377,7	277,8	109	3,47	-	-	-	-

Heating performance with 30% of outdoor and exhaust air

Airflow	Ta (°C) DB	Outdoor air temperature °C.D.B./W.B.																	
		-7 / -8			-5 / -6			0 / -1			2 / 1			7 / 6			12 / 11		
		kWt	kWe	COP	kWt	kWe	COP	kWt	kWe	COP	kWt	kWe	COP	kWt	kWe	COP	kWt	kWe	COP
38000 m ³ /h	10	276,7	57,4	4,82	290,2	59,8	4,85	323	67,5	4,79	335,4	70,7	4,74	366,2	78,5	4,66	394,8	87,4	4,52
	15	278,0	62,6	4,44	290,7	65,2	4,46	329,1	72,9	4,51	342,3	76,2	4,49	369,6	84,6	4,37	397,5	94,1	4,22
	18	278,4	65,7	4,24	291,9	68,6	4,26	328,9	76,6	4,29	341,4	80	4,27	370,8	88,5	4,19	400,3	99,1	4,04
	20	280,1	68,1	4,11	293,8	71,1	4,13	328,9	79,1	4,16	340,9	82,4	4,14	368,9	90,7	4,07	402,9	102,9	3,92
	22	281,9	70,5	4,00	295,8	73,6	4,02	328,8	81,5	4,03	339,7	84,7	4,01	365,5	92,6	3,95	405,5	106,7	3,80
	25	284,5	74,1	3,84	298,2	77,3	3,86	327,4	85	3,85	336,9	87,8	3,84	360,5	95,4	3,78	380,7	109,1	3,49
60000 m ³ /h	10	278,1	49,6	5,61	292,4	51,5	5,68	325,4	56,6	5,75	339,3	58,9	5,76	376,3	64,8	5,81	413,4	71,1	5,81
	15	279,2	54,0	5,17	292,4	55,8	5,24	329,9	60,5	5,45	346,5	63,4	5,47	381,3	70	5,45	417,6	77	5,42
	18	279,5	56,6	4,94	293	58,5	5,01	331,9	63,6	5,22	347,4	66,4	5,23	383,4	73,1	5,24	417,7	79,9	5,23
	20	280,5	58,5	4,79	294	60,5	4,86	333,2	65,7	5,07	347,9	68,4	5,09	382,2	75	5,10	416,2	81,6	5,10
	22	281,5	60,4	4,66	295,1	62,5	4,72	334,5	67,8	4,93	347,5	70,3	4,94	379,5	76,6	4,95	414,8	83,2	4,99
	25	283,1	63,3	4,47	296,5	65,4	4,53	332,8	70,9	4,69	345,2	73,3	4,71	375,6	79,1	4,75	412,8	86,1	4,79

kWf = Cooling capacity in kW

kWe = Compressor power input in kW

kWs = Sensible cooling capacity (kW)

kWt = Heating capacity (kW)

EER referred only to compressors

COP referred only to compressors

Ta = Indoor air temperature D.B./W.B

DB = dry bulb

WB = wet bulb

The fan motor heating is not considered.

Integrated heating capacities

Air temperature external exchanger inlet °C (D.B. / W.B.)	-5 / -5.4	0 / -0.6	5 / 3.9	Others
Heating capacity multiplication coefficient	0,89	0,88	0,94	1

The integrated heating capacity represents the real heating capacity considering the defrost cycles too.

To obtain the integrated heating capacity multiply the heating performance value in kWt (shown in the heating performance tables) by the coefficients indicated in the table.

DB = dry bulb

WB = wet bulb

In case of below zero external air temperature with a long period of heat pump operating mode it is necessary to help the evacuation of the water produced during the defrost cycle; this to avoid the formation of ice in the unit basement. Pay attention that the evacuation will not create inconveniences to things or persons.

Handling electric fan performance - Standard airflow

Available static pressure (Pa) (supply + return)		90	100	120	150	180	210	240	270	300	330	360	390	420	450	510	570	
49.4	Airflow	m ³ /h	26000	26000	26000	26000	26000	26000	26000	26000	26000	26000	26000	26000	26000	26000	26000	26000
	Airflow	l/s	7222	7222	7222	7222	7222	7222	7222	7222	7222	7222	7222	7222	7222	7222	7222	7222
	Fan RPM	rpm	1183	1192	1210	1236	1262	1285	1311	1337	1364	1387	1413	1439	1462	1488	1535	1585
	Sound power	dB(A)	83,2	83,2	83,1	83,4	83,7	84	84,4	84,6	84,6	84,6	84,6	84,7	84,7	84,7	85	85,7
	Total input	kW	2,94	3,03	3,21	3,48	3,77	4,02	4,34	4,65	4,92	5,16	5,44	5,74	6,00	6,31	6,92	7,60
54.4	Airflow	m ³ /h	29000	29000	29000	29000	29000	29000	29000	29000	29000	29000	29000	29000	29000	29000	29000	-
	Airflow	l/s	8056	8056	8056	8056	8056	8056	8056	8056	8056	8056	8056	8056	8056	8056	8056	-
	Fan RPM	rpm	1300	1308	1323	1347	1368	1392	1413	1436	1460	1481	1505	1526	1550	1574	1619	-
	Sound power	dB(A)	85,7	85,6	85,6	85,5	85,6	85,9	86,1	86,4	86,7	87,0	87,0	87,0	87,0	87,0	87,1	-
	Total input	kW	3,77	3,86	4,04	4,34	4,62	4,93	5,21	5,55	5,90	6,23	6,56	6,83	7,15	7,47	8,11	-
60.4	Airflow	m ³ /h	33000	33000	33000	33000	33000	33000	33000	33000	33000	33000	33000	33000	33000	33000	33000	33000
	Airflow	l/s	9167	9167	9167	9167	9167	9167	9167	9167	9167	9167	9167	9167	9167	9167	9167	9167
	Fan RPM	rpm	1141	1150	1166	1194	1221	1246	1274	1299	1327	1355	1379	1407	1435	1457	1507	1559
	Sound power	dB(A)	83,4	83,4	83,5	83,9	84,2	84,6	84,9	84,9	84,9	84,9	84,9	85,0	85,0	85,2	85,9	86,6
	Total input	kW	3,60	3,72	3,91	4,28	4,64	5,00	5,40	5,72	6,04	6,44	6,76	7,16	7,56	7,92	8,72	9,68
70.4	Airflow	m ³ /h	37000	37000	37000	37000	37000	37000	37000	37000	37000	37000	37000	37000	37000	37000	37000	-
	Airflow	l/s	10278	10278	10278	10278	10278	10278	10278	10278	10278	10278	10278	10278	10278	10278	10278	-
	Fan RPM	rpm	1257	1263	1280	1305	1327	1351	1378	1398	1423	1445	1470	1495	1517	1542	1590	-
	Sound power	dB(A)	86	86,0	85,9	85,9	86,2	86,5	86,8	87,1	87,4	87,4	87,4	87,4	87,4	87,4	87,5	-
	Total input	kW	4,60	4,72	4,96	5,36	5,72	6,12	6,52	6,92	7,40	7,76	8,16	8,56	8,92	9,36	10,24	-
80.4	Airflow	m ³ /h	44000	44000	44000	44000	44000	44000	44000	44000	44000	44000	44000	-	-	-	-	-
	Airflow	l/s	12222	12222	12222	12222	12222	12222	12222	12222	12222	12222	12222	-	-	-	-	-
	Fan RPM	rpm	1456	1463	1477	1497	1518	1539	1558	1579	1597	1618	1636	-	-	-	-	-
	Sound power	dB(A)	89,9	89,8	89,8	89,7	89,7	89,6	89,8	90,0	90,2	90,4	90,6	-	-	-	-	-
	Total input	kW	6,84	6,96	7,28	7,68	8,12	8,60	9,00	9,48	9,92	10,44	10,92	-	-	-	-	-
90.4	Airflow	m ³ /h	51000	51000	51000	51000	51000	51000	51000	51000	51000	51000	51000	51000	51000	51000	51000	51000
	Airflow	l/s	14167	14167	14167	14167	14167	14167	14167	14167	14167	14167	14167	14167	14167	14167	14167	14167
	Fan RPM	rpm	1184	1193	1211	1235	1262	1289	1313	1340	1364	1391	1418	1442	1468	1491	1540	1591
	Sound power	dB(A)	85,9	85,8	86,0	86,4	86,7	87,1	87,3	87,3	87,3	87,3	87,4	87,4	87,5	87,5	88,2	88,8
	Total input	kW	6,06	6,24	6,60	7,08	7,62	8,28	8,82	9,36	9,84	10,38	10,98	11,52	12,12	12,72	13,98	15,36
100.4	Airflow	m ³ /h	56000	56000	56000	56000	56000	56000	56000	56000	56000	56000	56000	56000	56000	56000	56000	-
	Airflow	l/s	15556	15556	15556	15556	15556	15556	15556	15556	15556	15556	15556	15556	15556	15556	15556	-
	Fan RPM	rpm	1286	1294	1310	1332	1357	1381	1403	1427	1452	1474	1496	1521	1545	1570	1615	-
	Sound power	dB(A)	87,9	87,9	87,9	88,1	88,4	88,6	88,9	89,2	89,4	89,3	89,3	89,3	89,4	89,4	89,5	-
	Total input	kW	7,56	7,68	8,10	8,64	9,24	9,84	10,44	11,16	11,82	12,30	12,84	13,50	14,16	14,82	16,08	-
110.4	Airflow	m ³ /h	60000	60000	60000	60000	60000	60000	60000	60000	60000	60000	60000	60000	60000	60000	-	-
	Airflow	l/s	16667	16667	16667	16667	16667	16667	16667	16667	16667	16667	16667	16667	16667	16667	-	-
	Fan RPM	rpm	1364	1372	1387	1408	1431	1451	1476	1496	1517	1540	1563	1583	1606	1627	-	-
	Sound power	dB(A)	89,4	89,4	89,4	89,4	89,6	89,9	90,1	90,4	90,6	90,9	90,9	90,8	90,8	90,9	-	-
	Total input	kW	8,76	9,00	9,42	9,96	10,62	11,16	11,94	12,60	13,26	14,04	14,64	15,24	15,90	16,50	-	-

The performance takes into account the pressure drops in the unit (pressure drops in handling coil, standard filters, etc.).
To determine the performance required of the fans, you must add to the usable static pressure desired the pressure drops of any accessories.

Handling electric fan performance - Minimum airflow

Available static pressure (Pa) (supply + return)			90	100	120	150	180	210	240	270	300	330	360	390	420	450	510
49.4	Airflow	m ³ /h	22000	22000	22000	22000	22000	22000	22000	22000	22000	22000	22000	22000	22000	22000	22000
	Airflow	l/s	6111	6111	6111	6111	6111	6111	6111	6111	6111	6111	6111	6111	6111	6111	6111
	Fan RPM	rpm	1032	1043	1060	1091	1120	1152	1180	1212	1239	1270	1297	1327	1354	1384	1439
	Sound power	dB(A)	79,6	79,7	80,0	80,4	80,9	81,0	81,0	81,0	81,1	81,1	81,3	81,8	82,3	82,7	83,6
	Total input	kW	2,09	2,17	2,31	2,56	2,81	3,06	3,27	3,51	3,72	3,99	4,25	4,53	4,80	5,10	5,73
54.4	Airflow	m ³ /h	22000	22000	22000	22000	22000	22000	22000	22000	22000	22000	22000	22000	22000	22000	22000
	Airflow	l/s	6111	6111	6111	6111	6111	6111	6111	6111	6111	6111	6111	6111	6111	6111	6111
	Fan RPM	rpm	1032	1043	1060	1091	1120	1152	1180	1212	1239	1270	1297	1327	1354	1384	1439
	Sound power	dB(A)	79,6	79,7	80,0	80,4	80,9	81,0	81,0	81,0	81,1	81,1	81,3	81,8	82,3	82,7	83,6
	Total input	kW	2,09	2,17	2,31	2,56	2,81	3,06	3,27	3,51	3,72	3,99	4,25	4,53	4,80	5,10	5,73
60.4	Airflow	m ³ /h	29000	29000	29000	29000	29000	29000	29000	29000	29000	29000	29000	29000	29000	29000	29000
	Airflow	l/s	8056	8056	8056	8056	8056	8056	8056	8056	8056	8056	8056	8056	8056	8056	8056
	Fan RPM	rpm	1029	1040	1057	1086	1118	1150	1178	1210	1238	1266	1296	1327	1353	1380	1439
	Sound power	dB(A)	80,7	80,8	81,1	81,6	82,1	82,1	82,1	82,1	82,2	82,2	82,6	83,0	83,5	84,0	84,9
	Total input	kW	2,79	2,89	3,07	3,38	3,75	4,04	4,32	4,68	4,96	5,28	5,64	6,04	6,40	6,76	7,60
70.4	Airflow	m ³ /h	29000	29000	29000	29000	29000	29000	29000	29000	29000	29000	29000	29000	29000	29000	29000
	Airflow	l/s	8056	8056	8056	8056	8056	8056	8056	8056	8056	8056	8056	8056	8056	8056	8056
	Fan RPM	rpm	1029	1040	1057	1086	1118	1150	1178	1210	1238	1266	1296	1327	1353	1380	1439
	Sound power	dB(A)	80,7	80,8	81,1	81,6	82,1	82,1	82,1	82,1	82,2	82,2	82,6	83,0	83,5	84,0	84,9
	Total input	kW	2,79	2,89	3,07	3,38	3,75	4,04	4,32	4,68	4,96	5,28	5,64	6,04	6,40	6,76	7,60
80.4	Airflow	m ³ /h	29000	29000	29000	29000	29000	29000	29000	29000	29000	29000	29000	29000	29000	29000	29000
	Airflow	l/s	8056	8056	8056	8056	8056	8056	8056	8056	8056	8056	8056	8056	8056	8056	8056
	Fan RPM	rpm	1029	1040	1057	1086	1118	1150	1178	1210	1238	1266	1296	1327	1353	1380	1439
	Sound power	dB(A)	80,7	80,8	81,1	81,6	82,1	82,1	82,1	82,1	82,2	82,2	82,6	83,0	83,5	84,0	84,9
	Total input	kW	2,79	2,89	3,07	3,38	3,75	4,04	4,32	4,68	4,96	5,28	5,64	6,04	6,40	6,76	7,60
90.4	Airflow	m ³ /h	38000	38000	38000	38000	38000	38000	38000	38000	38000	38000	38000	38000	38000	38000	38000
	Airflow	l/s	10556	10556	10556	10556	10556	10556	10556	10556	10556	10556	10556	10556	10556	10556	10556
	Fan RPM	rpm	942	954	978	1011	1044	1080	1111	1146	1177	1211	1245	1274	1307	1335	1393
	Sound power	dB(A)	80,3	80,6	81,0	80,9	81,0	81,0	81,1	81,7	82,3	82,9	83,5	84,2	85,0	85,7	87,1
	Total input	kW	3,44	3,60	3,92	4,28	4,66	5,10	5,51	6,00	6,48	7,02	7,56	8,40	8,64	9,12	10,26
100.4	Airflow	m ³ /h	38000	38000	38000	38000	38000	38000	38000	38000	38000	38000	38000	38000	38000	38000	38000
	Airflow	l/s	10556	10556	10556	10556	10556	10556	10556	10556	10556	10556	10556	10556	10556	10556	10556
	Fan RPM	rpm	942	954	978	1011	1044	1080	1111	1146	1177	1211	1245	1274	1307	1335	1393
	Sound power	dB(A)	80,3	80,6	81,0	80,9	81,0	81,0	81,1	81,7	82,3	82,9	83,5	84,2	85,0	85,7	87,1
	Total input	kW	3,44	3,60	3,92	4,28	4,66	5,10	5,51	6,00	6,48	7,02	7,56	8,40	8,64	9,12	10,26
110.4	Airflow	m ³ /h	38000	38000	38000	38000	38000	38000	38000	38000	38000	38000	38000	38000	38000	38000	38000
	Airflow	l/s	10556	10556	10556	10556	10556	10556	10556	10556	10556	10556	10556	10556	10556	10556	10556
	Fan RPM	rpm	942	954	978	1011	1044	1080	1111	1146	1177	1211	1245	1274	1307	1335	1393
	Sound power	dB(A)	80,3	80,6	81,0	80,9	81,0	81,0	81,1	81,7	82,3	82,9	83,5	84,2	85,0	85,7	87,1
	Total input	kW	3,44	3,60	3,92	4,28	4,66	5,10	5,51	6,00	6,48	7,02	7,56	8,40	8,64	9,12	10,26

The performance takes into account the pressure drops in the unit (pressure drops in handling coil, standard filters, etc.).
 To determine the performance required of the fans, you must add to the usable static pressure desired the pressure drops of any accessories.

Handling electric fan performance - High airflow

Available static pressure (Pa) (supply + return)			90	100	120	150	180	210	240	270	300	330	360	390	420	450
49.4	Airflow	m ³ /h	34000	34000	34000	34000	34000	34000	34000	34000	34000	-	-	-	-	-
	Airflow	l/s	9444	9444	9444	9444	9444	9444	9444	9444	9444	-	-	-	-	-
	Fan RPM	rpm	1484	1493	1505	1527	1546	1567	1585	1603	1624	-	-	-	-	-
	Sound power	dB(A)	89,3	89,2	89,2	89,1	89,0	89,0	89,0	89,1	89,3	-	-	-	-	-
	Total input	kW	5,37	5,52	5,70	6,06	6,36	6,72	7,05	7,38	7,77	-	-	-	-	-
54.4	Airflow	m ³ /h	34000	34000	34000	34000	34000	34000	34000	34000	34000	-	-	-	-	-
	Airflow	l/s	9444	9444	9444	9444	9444	9444	9444	9444	9444	-	-	-	-	-
	Fan RPM	rpm	1484	1493	1505	1527	1546	1567	1585	1603	1624	-	-	-	-	-
	Sound power	dB(A)	89,3	89,2	89,2	89,1	89,0	89,0	89,0	89,1	89,3	-	-	-	-	-
	Total input	kW	5,37	5,52	5,70	6,06	6,36	6,72	7,05	7,38	7,77	-	-	-	-	-
60.4	Airflow	m ³ /h	47000	47000	47000	47000	47000	47000	47000	47000	-	-	-	-	-	-
	Airflow	l/s	13056	13056	13056	13056	13056	13056	13056	13056	-	-	-	-	-	-
	Fan RPM	rpm	1545	1552	1566	1586	1605	1625	1641	-	-	-	-	-	-	-
	Sound power	dB(A)	91,4	91,4	91,3	91,2	91,2	91,1	91,1	-	-	-	-	-	-	-
	Total input	kW	8,04	8,20	8,52	9,00	9,44	9,92	10,36	-	-	-	-	-	-	-
70.4	Airflow	m ³ /h	47000	47000	47000	47000	47000	47000	47000	47000	-	-	-	-	-	-
	Airflow	l/s	13056	13056	13056	13056	13056	13056	13056	13056	-	-	-	-	-	-
	Fan RPM	rpm	1545	1552	1566	1586	1605	1625	1641	-	-	-	-	-	-	-
	Sound power	dB(A)	91,4	91,4	91,3	91,2	91,2	91,1	91,1	-	-	-	-	-	-	-
	Total input	kW	8,04	8,20	8,52	9,00	9,44	9,92	10,36	-	-	-	-	-	-	-
80.4	Airflow	m ³ /h	47000	47000	47000	47000	47000	47000	47000	47000	-	-	-	-	-	-
	Airflow	l/s	13056	13056	13056	13056	13056	13056	13056	13056	-	-	-	-	-	-
	Fan RPM	rpm	1545	1552	1566	1586	1605	1625	1641	-	-	-	-	-	-	-
	Sound power	dB(A)	91,4	91,4	91,3	91,2	91,2	91,1	91,1	-	-	-	-	-	-	-
	Total input	kW	8,04	8,20	8,52	9,00	9,44	9,92	10,36	-	-	-	-	-	-	-
90.4	Airflow	m ³ /h	60000	60000	60000	60000	60000	60000	60000	60000	60000	60000	60000	60000	60000	60000
	Airflow	l/s	16667	16667	16667	16667	16667	16667	16667	16667	16667	16667	16667	16667	16667	16667
	Fan RPM	rpm	1366	1371	1387	1410	1431	1454	1474	1497	1518	1541	1562	1585	1606	1627
	Sound power	dB(A)	89,4	89,4	89,4	89,4	89,6	89,9	90,1	90,4	90,6	90,9	90,9	90,8	90,8	90,9
	Total input	kW	8,82	8,94	9,36	10,02	10,62	11,28	11,88	12,60	13,26	14,04	14,64	15,30	15,84	16,50
100.4	Airflow	m ³ /h	60000	60000	60000	60000	60000	60000	60000	60000	60000	60000	60000	60000	60000	60000
	Airflow	l/s	16667	16667	16667	16667	16667	16667	16667	16667	16667	16667	16667	16667	16667	16667
	Fan RPM	rpm	1366	1371	1387	1410	1431	1454	1474	1497	1518	1541	1562	1585	1606	1627
	Sound power	dB(A)	89,4	89,4	89,4	89,4	89,6	89,9	90,1	90,4	90,6	90,9	90,9	90,8	90,8	90,9
	Total input	kW	8,82	8,94	9,36	10,02	10,62	11,28	11,88	12,60	13,26	14,04	14,64	15,30	15,84	16,50
110.4	Airflow	m ³ /h	60000	60000	60000	60000	60000	60000	60000	60000	60000	60000	60000	60000	60000	60000
	Airflow	l/s	16667	16667	16667	16667	16667	16667	16667	16667	16667	16667	16667	16667	16667	16667
	Fan RPM	rpm	1366	1371	1387	1410	1431	1454	1474	1497	1518	1541	1562	1585	1606	1627
	Sound power	dB(A)	89,4	89,4	89,4	89,4	89,6	89,9	90,1	90,4	90,6	90,9	90,9	90,8	90,8	90,9
	Total input	kW	8,82	8,94	9,36	10,02	10,62	11,28	11,88	12,60	13,26	14,04	14,64	15,30	15,84	16,50

The performance takes into account the pressure drops in the unit (pressure drops in handling coil, standard filters, etc.).
To determine the performance required of the fans, you must add to the usable static pressure desired the pressure drops of any accessories.

High static pressure electric fan performance - Standard airflow

Available static pressure (Pa) (supply+return)			300	360	420	480	540	600	660	720	780	840	900	960	1020	1080	1140	
49,4	Airflow	m ³ /h	26000	26000	26000	26000	26000	26000	26000	26000	26000	26000	26000	26000	26000	26000	26000	26000
	Airflow	l/s	7222	7222	7222	7222	7222	7222	7222	7222	7222	7222	7222	7222	7222	7222	7222	7222
	Fan RPM	rpm	1550	1593	1638	1682	1727	1775	1817	1854	1900	1940	1981	2020	2055	2098	2136	
	Sound power	dB(A)	94,4	94,2	94,2	94,4	94,8	95,1	95,4	95,7	96,1	96,4	96,8	97,2	97,5	97,9	98,3	
	Total input	kW	5,37	5,91	6,51	7,08	7,68	8,37	9,00	9,60	10,38	11,07	11,73	12,42	13,05	13,99	14,61	
54,4	Airflow	m ³ /h	29000	29000	29000	29000	29000	29000	29000	29000	29000	29000	29000	29000	29000	29000	29000	-
	Airflow	l/s	8056	8056	8056	8056	8056	8056	8056	8056	8056	8056	8056	8056	8056	8056	8056	-
	Fan RPM	rpm	1673	1713	1753	1798	1833	1877	1917	1956	1995	2032	2070	2111	2147	2181	-	
	Sound power	dB(A)	97,0	96,8	96,7	96,6	96,6	96,8	97,1	97,3	97,6	97,8	98,1	98,4	98,7	98,9	-	
	Total input	kW	6,48	7,08	7,68	8,37	8,97	9,69	10,35	11,04	11,76	12,48	13,23	14,10	14,91	15,60	-	
60,4	Airflow	m ³ /h	33000	33000	33000	33000	33000	33000	33000	33000	33000	33000	33000	33000	33000	33000	33000	33000
	Airflow	l/s	9167	9167	9167	9167	9167	9167	9167	9167	9167	9167	9167	9167	9167	9167	9167	9167
	Fan RPM	rpm	1500	1548	1596	1643	1690	1732	1777	1821	1867	1907	1946	1991	2031	2069	2109	
	Sound power	dB(A)	94,5	94,4	94,6	95,0	95,3	95,7	96,1	96,4	96,8	97,2	97,7	98,1	98,5	98,9	99,3	
	Total input	kW	6,64	7,40	8,12	8,92	9,72	10,48	11,36	12,24	13,20	14,00	14,84	15,84	16,80	17,72	18,72	
70,4	Airflow	m ³ /h	37000	37000	37000	37000	37000	37000	37000	37000	37000	37000	37000	37000	37000	37000	37000	37000
	Airflow	l/s	10278	10278	10278	10278	10278	10278	10278	10278	10278	10278	10278	10278	10278	10278	10278	10278
	Fan RPM	rpm	1626	1668	1711	1750	1793	1835	1877	1918	1955	1995	2034	2067	2109	2147	2184	
	Sound power	dB(A)	97,3	97,1	97,0	96,9	97,2	97,4	97,7	98,0	98,3	98,6	98,9	99,2	99,5	99,8	100,2	
	Total input	kW	8,08	8,84	9,68	10,48	11,32	12,16	13,08	14,00	14,88	15,88	16,88	17,76	18,84	19,84	20,88	
80,4	Airflow	m ³ /h	44000	44000	44000	44000	44000	44000	44000	44000	44000	44000	44000	-	-	-	-	
	Airflow	l/s	12222	12222	12222	12222	12222	12222	12222	12222	12222	12222	12222	-	-	-	-	
	Fan RPM	rpm	1852	1889	1926	1962	1995	2031	2067	2102	2136	2171	2206	-	-	-	-	
	Sound power	dB(A)	101,4	101,2	101,0	100,9	100,8	100,7	100,7	100,7	100,9	101,1	101,3	-	-	-	-	
	Total input	kW	11,32	12,16	13,04	13,96	14,84	15,84	16,88	17,92	18,84	19,88	20,96	-	-	-	-	
90,4	Airflow	m ³ /h	51000	51000	51000	51000	51000	51000	51000	51000	51000	51000	51000	51000	51000	51000	51000	51000
	Airflow	l/s	14167	14167	14167	14167	14167	14167	14167	14167	14167	14167	14167	14167	14167	14167	14167	14167
	Fan RPM	rpm	1546	1592	1639	1685	1730	1771	1815	1858	1900	1942	1980	2018	2058	2100	2139	
	Sound power	dB(A)	97,0	96,9	97,0	97,4	97,7	98,1	98,4	98,7	99,1	99,5	99,9	100,2	100,6	101,0	101,4	
	Total input	kW	10,80	11,94	13,14	14,28	15,54	16,74	18,06	19,38	20,82	22,14	23,46	24,78	26,22	27,78	29,34	
100,4	Airflow	m ³ /h	56000	56000	56000	56000	56000	56000	56000	56000	56000	56000	56000	56000	56000	56000	56000	56000
	Airflow	l/s	15556	15556	15556	15556	15556	15556	15556	15556	15556	15556	15556	15556	15556	15556	15556	15556
	Fan RPM	rpm	1652	1695	1737	1779	1821	1860	1901	1942	1982	2018	2057	2093	2131	2171	2206	
	Sound power	dB(A)	99,2	99,0	98,9	98,9	99,2	99,5	99,7	100,0	100,3	100,6	100,9	101,2	101,5	101,8	102,2	
	Total input	kW	12,78	13,92	15,24	16,50	17,82	19,02	20,40	21,78	23,28	24,66	26,22	27,60	29,10	30,78	32,22	
110,4	Airflow	m ³ /h	60000	60000	60000	60000	60000	60000	60000	60000	60000	60000	60000	60000	60000	-	-	
	Airflow	l/s	16667	16667	16667	16667	16667	16667	16667	16667	16667	16667	16667	16667	16667	-	-	
	Fan RPM	rpm	1740	1780	1816	1856	1895	1935	1974	2010	2048	2086	2126	2160	2193	-	-	
	Sound power	dB(A)	100,7	100,7	100,5	100,5	100,4	100,6	100,8	101,1	101,3	101,6	101,8	102,1	102,3	-	-	
	Total input	kW	14,58	15,78	16,98	18,36	19,80	21,12	22,56	23,88	25,38	26,94	28,62	30,12	31,68	-	-	

The performance takes into account the pressure drops in the unit (pressure drops in handling coil, standard filters, etc.).
 To determine the performance required of the fans, you must add to the usable static pressure desired the pressure drops of any accessories.
 Performances with "VENH - High static pressure electric fans" option.

High static pressure electric fan performance - Minimum airflow

Available static pressure (Pa) (supply+return)			420	480	540	600	660	720	780	840	900	960	1020	1080	1140	1200	1260	1320	
49,4	Airflow	m ³ /h	22000	22000	22000	22000	22000	22000	22000	22000	22000	22000	22000	22000	22000	22000	22000	22000	22000
	Airflow	l/s	6111	6111	6111	6111	6111	6111	6111	6111	6111	6111	6111	6111	6111	6111	6111	6111	6111
	Fan RPM	rpm	1496	1545	1596	1642	1692	1737	1785	1828	1874	1919	1957	2000	2044	2081	2126	2161	2161
	Sound power	dB(A)	91,3	91,9	92,3	92,8	93,3	93,9	94,4	94,9	95,4	96,0	96,5	97,0	97,6	98,2	98,7	99,2	99,2
	Total input	kW	5,19	5,70	6,30	6,87	7,47	8,01	8,64	9,27	9,93	10,65	11,25	11,94	12,63	13,26	14,07	14,70	14,70
54,4	Airflow	m ³ /h	22000	22000	22000	22000	22000	22000	22000	22000	22000	22000	22000	22000	22000	22000	22000	22000	22000
	Airflow	l/s	6111	6111	6111	6111	6111	6111	6111	6111	6111	6111	6111	6111	6111	6111	6111	6111	6111
	Fan RPM	rpm	1496	1545	1596	1642	1692	1737	1785	1828	1874	1919	1957	2000	2044	2081	2126	2161	2161
	Sound power	dB(A)	91,3	91,9	92,3	92,8	93,3	93,9	94,4	94,9	95,4	96,0	96,5	97,0	97,6	98,2	98,7	99,2	99,2
	Total input	kW	5,19	5,70	6,30	6,87	7,47	8,01	8,64	9,27	9,93	10,65	11,25	11,94	12,63	13,26	14,07	14,70	14,70
60,4	Airflow	m ³ /h	29000	29000	29000	29000	29000	29000	29000	29000	29000	29000	29000	29000	29000	29000	29000	29000	29000
	Airflow	l/s	8056	8056	8056	8056	8056	8056	8056	8056	8056	8056	8056	8056	8056	8056	8056	8056	8056
	Fan RPM	rpm	1489	1542	1590	1644	1686	1732	1783	1826	1869	1914	1953	1994	2040	2080	2122	2164	2164
	Sound power	dB(A)	92,6	93,0	93,5	94,0	94,5	95,1	95,6	96,2	96,7	97,2	97,8	98,4	99,0	99,5	100,1	100,6	100,6
	Total input	kW	6,84	7,60	8,32	9,16	9,84	10,60	11,52	12,32	13,16	14,08	14,88	15,72	16,72	17,64	18,60	19,64	19,64
70,4	Airflow	m ³ /h	29000	29000	29000	29000	29000	29000	29000	29000	29000	29000	29000	29000	29000	29000	29000	29000	29000
	Airflow	l/s	8056	8056	8056	8056	8056	8056	8056	8056	8056	8056	8056	8056	8056	8056	8056	8056	8056
	Fan RPM	rpm	1489	1542	1590	1644	1686	1732	1783	1826	1869	1914	1953	1994	2040	2080	2122	2164	2164
	Sound power	dB(A)	92,6	93,0	93,5	94,0	94,5	95,1	95,6	96,2	96,7	97,2	97,8	98,4	99,0	99,5	100,1	100,6	100,6
	Total input	kW	6,84	7,60	8,32	9,16	9,84	10,60	11,52	12,32	13,16	14,08	14,88	15,72	16,72	17,64	18,60	19,64	19,64
80,4	Airflow	m ³ /h	29000	29000	29000	29000	29000	29000	29000	29000	29000	29000	29000	29000	29000	29000	29000	29000	29000
	Airflow	l/s	8056	8056	8056	8056	8056	8056	8056	8056	8056	8056	8056	8056	8056	8056	8056	8056	8056
	Fan RPM	rpm	1489	1542	1590	1644	1686	1732	1783	1826	1869	1914	1953	1994	2040	2080	2122	2164	2164
	Sound power	dB(A)	92,6	93,0	93,5	94,0	94,5	95,1	95,6	96,2	96,7	97,2	97,8	98,4	99,0	99,5	100,1	100,6	100,6
	Total input	kW	6,84	7,60	8,32	9,16	9,84	10,60	11,52	12,32	13,16	14,08	14,88	15,72	16,72	17,64	18,60	19,64	19,64
90,4	Airflow	m ³ /h	38000	38000	38000	38000	38000	38000	38000	38000	38000	38000	38000	38000	38000	38000	38000	38000	38000
	Airflow	l/s	10556	10556	10556	10556	10556	10556	10556	10556	10556	10556	10556	10556	10556	10556	10556	10556	10556
	Fan RPM	rpm	1418	1467	1523	1578	1627	1675	1726	1772	1821	1870	1910	1957	2000	2042	2086	2127	2127
	Sound power	dB(A)	92,7	93,3	94,1	94,8	95,5	96,2	96,9	97,7	98,4	99,1	99,8	100,5	101,2	101,8	102,5	103,1	103,1
	Total input	kW	9,18	10,02	11,10	12,24	13,32	14,40	15,60	16,68	17,94	19,20	20,34	21,72	22,98	24,30	25,80	27,12	27,12
100,4	Airflow	m ³ /h	38000	38000	38000	38000	38000	38000	38000	38000	38000	38000	38000	38000	38000	38000	38000	38000	38000
	Airflow	l/s	10556	10556	10556	10556	10556	10556	10556	10556	10556	10556	10556	10556	10556	10556	10556	10556	10556
	Fan RPM	rpm	1418	1467	1523	1578	1627	1675	1726	1772	1821	1870	1910	1957	2000	2042	2086	2127	2127
	Sound power	dB(A)	92,7	93,3	94,1	94,8	95,5	96,2	96,9	97,7	98,4	99,1	99,8	100,5	101,2	101,8	102,5	103,1	103,1
	Total input	kW	9,18	10,02	11,10	12,24	13,32	14,40	15,60	16,68	17,94	19,20	20,34	21,72	22,98	24,30	25,80	27,12	27,12
110,4	Airflow	m ³ /h	38000	38000	38000	38000	38000	38000	38000	38000	38000	38000	38000	38000	38000	38000	38000	38000	38000
	Airflow	l/s	10556	10556	10556	10556	10556	10556	10556	10556	10556	10556	10556	10556	10556	10556	10556	10556	10556
	Fan RPM	rpm	1418	1467	1523	1578	1627	1675	1726	1772	1821	1870	1910	1957	2000	2042	2086	2127	2127
	Sound power	dB(A)	92,7	93,3	94,1	94,8	95,5	96,2	96,9	97,7	98,4	99,1	99,8	100,5	101,2	101,8	102,5	103,1	103,1
	Total input	kW	9,18	10,02	11,10	12,24	13,32	14,40	15,60	16,68	17,94	19,20	20,34	21,72	22,98	24,30	25,80	27,12	27,12

The performance takes into account the pressure drops in the unit (pressure drops in handling coil, standard filters, etc.).
 To determine the performance required of the fans, you must add to the usable static pressure desired the pressure drops of any accessories.
 Performances with "VENH - High static pressure electric fans" option.

High static pressure electric fan performance - High airflow

Available static pressure (Pa) (supply+return)			240	300	360	420	480	540	600	660	720	780	840	900	960	1020
49,4	Airflow	m ³ /h	34000	34000	34000	34000	34000	34000	34000	34000	34000	34000	34000	-	-	-
	Airflow	l/s	9444	9444	9444	9444	9444	9444	9444	9444	9444	9444	9444	-	-	-
	Fan RPM	rpm	1901	1884	1919	1956	1990	2026	2059	2095	2128	2164	2197	-	-	-
	Sound power	dB(A)	101,2	100,9	100,7	100,5	100,3	100,2	100,1	100,1	100,0	100,1	100,3	-	-	-
	Total input	kW	8,88	8,85	9,48	10,17	10,83	11,55	12,27	13,05	13,83	14,64	15,39	-	-	-
54,4	Airflow	m ³ /h	34000	34000	34000	34000	34000	34000	34000	34000	34000	34000	34000	-	-	-
	Airflow	l/s	9444	9444	9444	9444	9444	9444	9444	9444	9444	9444	9444	-	-	-
	Fan RPM	rpm	1901	1884	1919	1956	1990	2026	2059	2095	2128	2164	2197	-	-	-
	Sound power	dB(A)	101,2	100,9	100,7	100,5	100,3	100,2	100,1	100,1	100,0	100,1	100,3	-	-	-
	Total input	kW	8,88	8,85	9,48	10,17	10,83	11,55	12,27	13,05	13,83	14,64	15,39	-	-	-
60,4	Airflow	m ³ /h	47000	47000	47000	47000	47000	47000	47000	47000	47000	-	-	-	-	-
	Airflow	l/s	13056	13056	13056	13056	13056	13056	13056	13056	13056	-	-	-	-	-
	Fan RPM	rpm	1916	1949	1983	2019	2052	2086	2118	2153	2184	-	-	-	-	-
	Sound power	dB(A)	103,4	103,1	102,8	102,6	102,5	102,4	102,3	102,2	102,1	-	-	-	-	-
	Total input	kW	12,16	12,96	13,80	14,76	15,68	16,68	17,64	18,72	19,76	-	-	-	-	-
70,4	Airflow	m ³ /h	47000	47000	47000	47000	47000	47000	47000	47000	47000	-	-	-	-	-
	Airflow	l/s	13056	13056	13056	13056	13056	13056	13056	13056	13056	-	-	-	-	-
	Fan RPM	rpm	1916	1949	1983	2019	2052	2086	2118	2153	2184	-	-	-	-	-
	Sound power	dB(A)	103,4	103,1	102,8	102,6	102,5	102,4	102,3	102,2	102,1	-	-	-	-	-
	Total input	kW	12,16	12,96	13,80	14,76	15,68	16,68	17,64	18,72	19,76	-	-	-	-	-
80,4	Airflow	m ³ /h	47000	47000	47000	47000	47000	47000	47000	47000	47000	-	-	-	-	-
	Airflow	l/s	13056	13056	13056	13056	13056	13056	13056	13056	13056	-	-	-	-	-
	Fan RPM	rpm	1916	1949	1983	2019	2052	2086	2118	2153	2184	-	-	-	-	-
	Sound power	dB(A)	103,4	103,1	102,8	102,6	102,5	102,4	102,3	102,2	102,1	-	-	-	-	-
	Total input	kW	12,16	12,96	13,80	14,76	15,68	16,68	17,64	18,72	19,76	-	-	-	-	-
90,4	Airflow	m ³ /h	60000	60000	60000	60000	60000	60000	60000	60000	60000	60000	60000	60000	60000	60000
	Airflow	l/s	16667	16667	16667	16667	16667	16667	16667	16667	16667	16667	16667	16667	16667	16667
	Fan RPM	rpm	1700	1739	1779	1817	1857	1895	1935	1972	2009	2049	2084	2123	2160	2195
	Sound power	dB(A)	101,1	100,8	100,7	100,5	100,5	100,4	100,6	100,8	101,1	101,3	101,6	101,8	102,1	102,3
	Total input	kW	13,38	14,52	15,78	17,04	18,42	19,74	21,18	22,50	23,88	25,38	26,88	28,50	30,12	31,74
100,4	Airflow	m ³ /h	60000	60000	60000	60000	60000	60000	60000	60000	60000	60000	60000	60000	60000	60000
	Airflow	l/s	16667	16667	16667	16667	16667	16667	16667	16667	16667	16667	16667	16667	16667	16667
	Fan RPM	rpm	1700	1739	1779	1817	1857	1895	1935	1972	2009	2049	2084	2123	2160	2195
	Sound power	dB(A)	101,1	100,8	100,7	100,5	100,5	100,4	100,6	100,8	101,1	101,3	101,6	101,8	102,1	102,3
	Total input	kW	13,38	14,52	15,78	17,04	18,42	19,74	21,18	22,50	23,88	25,38	26,88	28,50	30,12	31,74
110,4	Airflow	m ³ /h	60000	60000	60000	60000	60000	60000	60000	60000	60000	60000	60000	60000	60000	60000
	Airflow	l/s	16667	16667	16667	16667	16667	16667	16667	16667	16667	16667	16667	16667	16667	16667
	Fan RPM	rpm	1700	1739	1779	1817	1857	1895	1935	1972	2009	2049	2084	2123	2160	2195
	Sound power	dB(A)	101,1	100,8	100,7	100,5	100,5	100,4	100,6	100,8	101,1	101,3	101,6	101,8	102,1	102,3
	Total input	kW	13,38	14,52	15,78	17,04	18,42	19,74	21,18	22,50	23,88	25,38	26,88	28,50	30,12	31,74

The performance takes into account the pressure drops in the unit (pressure drops in handling coil, standard filters, etc.).
 To determine the performance required of the fans, you must add to the usable static pressure desired the pressure drops of any accessories.
 Performances with "VENH - High static pressure electric fans" option.

Exhaust electric fan performance

% of exhaust air			10%	20%	30%	40%	50%
49.4	Airflow	m3/h	2600	5200	7800	10400	13000
	Airflow	l/s	722	1444	2167	2889	3611
	Fan RPM	rpm	663	707	811	955	1115
	Total input	kW	0,16	0,47	0,67	0,96	1,37
54.4	Airflow	m3/h	2900	5800	8700	11600	14500
	Airflow	l/s	806	1611	2417	3222	4028
	Fan RPM	rpm	665	726	858	1029	1212
	Total input	kW	0,33	0,51	0,75	1,13	1,66
60.4	Airflow	m3/h	3300	6600	9900	13200	16500
	Airflow	l/s	917	1833	2750	3667	4583
	Fan RPM	rpm	600	603	649	719	811
	Total input	kW	0,47	0,61	0,79	1,01	1,33
70.4	Airflow	m3/h	3700	7400	11100	14800	18500
	Airflow	l/s	1028	2056	3083	4111	5139
	Fan RPM	rpm	600	611	672	761	871
	Total input	kW	0,49	0,65	0,86	1,16	1,57
80.4	Airflow	m3/h	4400	8800	13200	17600	22000
	Airflow	l/s	1222	2444	3667	4889	6111
	Fan RPM	rpm	600	630	719	843	987
	Total input	kW	0,52	0,72	1,01	1,45	2,10
90.4	Airflow	m3/h	5200	10400	15600	20800	26000
	Airflow	l/s	1444	2889	4333	5778	7222
	Fan RPM	rpm	590	652	780	943	1123
	Total input	kW	0,54	0,80	1,21	1,88	2,88
100.4	Airflow	m3/h	5600	11200	16800	22400	28000
	Airflow	l/s	1556	3111	4667	6222	7778
	Fan RPM	rpm	591	669	815	998	1193
	Total input	kW	0,56	0,85	1,34	2,15	3,38
110.4	Airflow	m3/h	6000	12000	18000	24000	30000
	Airflow	l/s	1667	3333	5000	6667	8333
	Fan RPM	rpm	593	686	853	1052	1265
	Total input	kW	0,57	0,91	1,48	2,44	3,96

The percentage of exhaust air refers to the unit rated flow.

In the return section, the exhaust fans collect the quantity of air that will be exhausted.

The data refer to an available static pressure of 150 Pa which usually occurs in the systems to exhaust the air.

Option compatibility

REF.	DESCRIPTION	CAK	CBK	CCK	CCKP
Versions					
REC	Active energy recovery of the exhaust air (CCK version)	-	-	√	-
THR	THOR thermodynamic energy recovery of the exhaust air (CCKP version)	-	-	-	√
FC	Thermal FREE-COOLING	-	-	√	√
FCE	Enthalpy FREE-COOLING	-	-	0	0
Configurations					
CREFP	Device for consumption reduction of the external section at variable speed (phase-cutting)	√	√	√	√
CREFB	Device for consumption reduction of the external section ECOBREEZE fans	0	0	0	0
CHW2	Two-rows hot water coil	0	0	0	0
3WVM	Modulating 3-way valve	0	0	0	0
2WVM	Modulating 2-way valve	0	0	0	0
EH	Electric heaters.	0	0	0	0
GD	Gas heating module with 2-stage modulation	0	0	0	0
GC	Modulating condensation gas heating module	0	0	0	0
CHWER	Energy recovery from food refrigeration	0	0	0	0
AMRX	Rubber antivibration mounts	◇	◇	◇	◇
RCX	Roof curb	◇	◇	◇	◇
PCMO	Sandwich panels of the handling zone in M0 fire reaction class	0	0	0	0
Refrigeration circuit					
EVE	Electronic expansion valve	√	√	√	√
MHP	High and low pressure gauges	0	0	0	0
CPHG	Hot gas re-heating coil	0	0	0	0
Aeraulic circuit					
M0	Horizontal air supply	√	√	√	√
M3	Downward air supply	0	0	0	0
M5	Upflow air supply	0	0	0	0
RO	Horizontal air return	√	√	√	√
R3	Downward air return	0	0	0	0
PCOSM	Constant supply airflow	0	0	0	0
PVAR	Variable airflow	0	0	0	0
FPG4	Pleated air filter class G4 (EN779 norm)	√	√	√	√
F7	High efficiency F7 air filter	0	0	0	0
FES	Electronic filters	0	0	0	0
PSAF	Clogged filter differential pressure switch air side	0	0	0	0
HSE	Immersed electrodes steam humidifier	0	0	0	0
HWS	Water to waste evaporating wet-deck humidifier	0	0	0	0
LTEMP1	Application for low outdoor temperature	0	0	0	0
VENH	High head fans	0	0	0	0
AXI	High efficiency diffuser for axial fan - AxiTop	√	√	√	√
PAQC	Air quality probe for CO ₂ rate check	-	0	0	0
PAQCV	Air quality sensor for CO ₂ and VOC rate check	-	0	0	0
SER	Outdoor air damper manually set	-	√	-	-
SERM	Outdoor air motorized on/off damper	-	0	-	-
SFCM	Modulating motorized FREE-COOLING damper	-	0	√	√
SFCEM	Modulating motorized FREE-COOLING damper and min. outdoor air motorized on/off damper	-	-	0	0

√ Standard componen

0 Optional component

◇ The accessory can be separately supplied (optional)

- Not available

REF.	DESCRIPTION	CAK	CBK	CCK	CCKP
Electric circuit					
CRC	Remote control with user interface	√	√	√	√
NCRC	Remote control with user interface: not required	0	0	0	0
SIX	Service interface	◊	◊	◊	◊
MOB	Serial port RS485 with Modbus protocol	0	0	0	0
LON	RS485 serial port with LONWORKS protocol	0	0	0	0
BACIP	BACnet-IP communication module	0	0	0	0
CLMX	Clivet Master System	◊	◊	◊	◊
DESM	Smoke detector	0	0	0	0
PM	Phase monitor	√	√	√	√
MF2	Multi-function phase monitor	0	0	0	0
PFCP	Power factor correction capacitors (cosfi > 0.9)	0	0	0	0
SFSTC	Progressive compressor start-up device	0	0	0	0
Various					
PTCO	Set up for shipping via container	0	0	0	0

√ Standard componen

0 Optional component

◊ The accessory can be separately supplied (optional)

- Not available

Dimensional drawings

Size 49.4 - 54.4

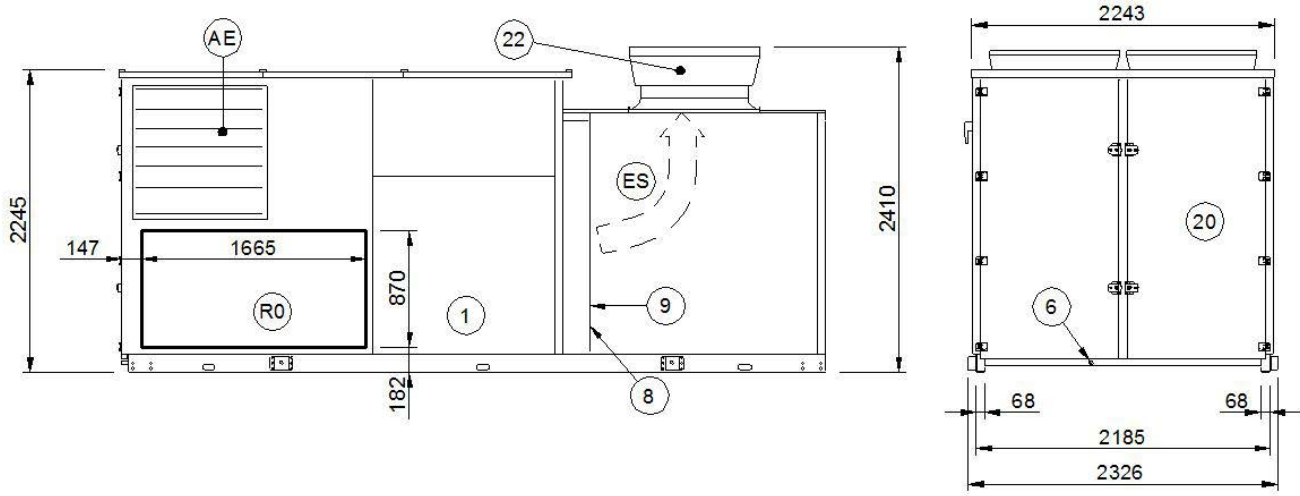

- | | |
|---|---|
| <ul style="list-style-type: none"> 1. Compressor compartment 2. Electrical panel 3. Connector for keyboard or PC connection 4. Power input 5. Humidifier connections 6. Condensate drain 7. Functional spaces 8. Water heating coil inlet Ø 1" 1/2 9. Water heating coil outlet Ø 1" 1/2 10. Reheat coil (optional) 11. Treatment coil 12. water heating coil (optional) 13. F7 / Electronic filters (optional) 14. Standard G4 filters | <ul style="list-style-type: none"> 15. Electric fan (supply - return) 16. Exhaust electric fan (CCK - CCKP version) 17. Lifting brackets (removable) 18. Outdoor air damper 19. Exhaust overpressure damper (CCK - CCKP version) 20. Access for coil - filter - heater inspection 21. Exhaust air recovery coil (only CCKP version) 22. Axitop (removable) <p>(R0) Horizontal air return
 (R3) Downward air return (optional)
 (M0) Horizontal air supply
 (M3) Downward air supply (optional)
 (M5) Upflow air supply
 (AE) Outdoor air intake
 (ES) Exhaust air (CCK - CCKP version)
 (H1) Wall with same height as unit on a maximum of three sides
 (*) Anti-vibration mount position
 (**) Suggested minimum clearance</p> |
|---|---|

WEIGHT DISTRIBUTION

Size	kg	49.4			54.4		
		CAK/CBK	CCK	CCKP	CAK/CBK	CCK	CCKP
W1 Supporting point	kg	427	449	468	490	512	531
W2 Supporting point	kg	383	403	420	440	460	477
W3 Supporting point	kg	317	334	348	364	381	395
W4 Supporting point	kg	317	334	348	364	381	395
W5 Supporting point	kg	350	369	384	402	420	436
W6 Supporting point	kg	394	415	432	452	473	490
Operating weight	kg	2189	2304	2400	2512	2628	2724
Shipping weight	kg	2189	2304	2400	2512	2628	2724

The presence of optional accessories may result in a substantial variation of the weights shown in the table.

Size 49.4 - 54.4

DAA7V49_4_54_4_03
Date: 29/09/2014

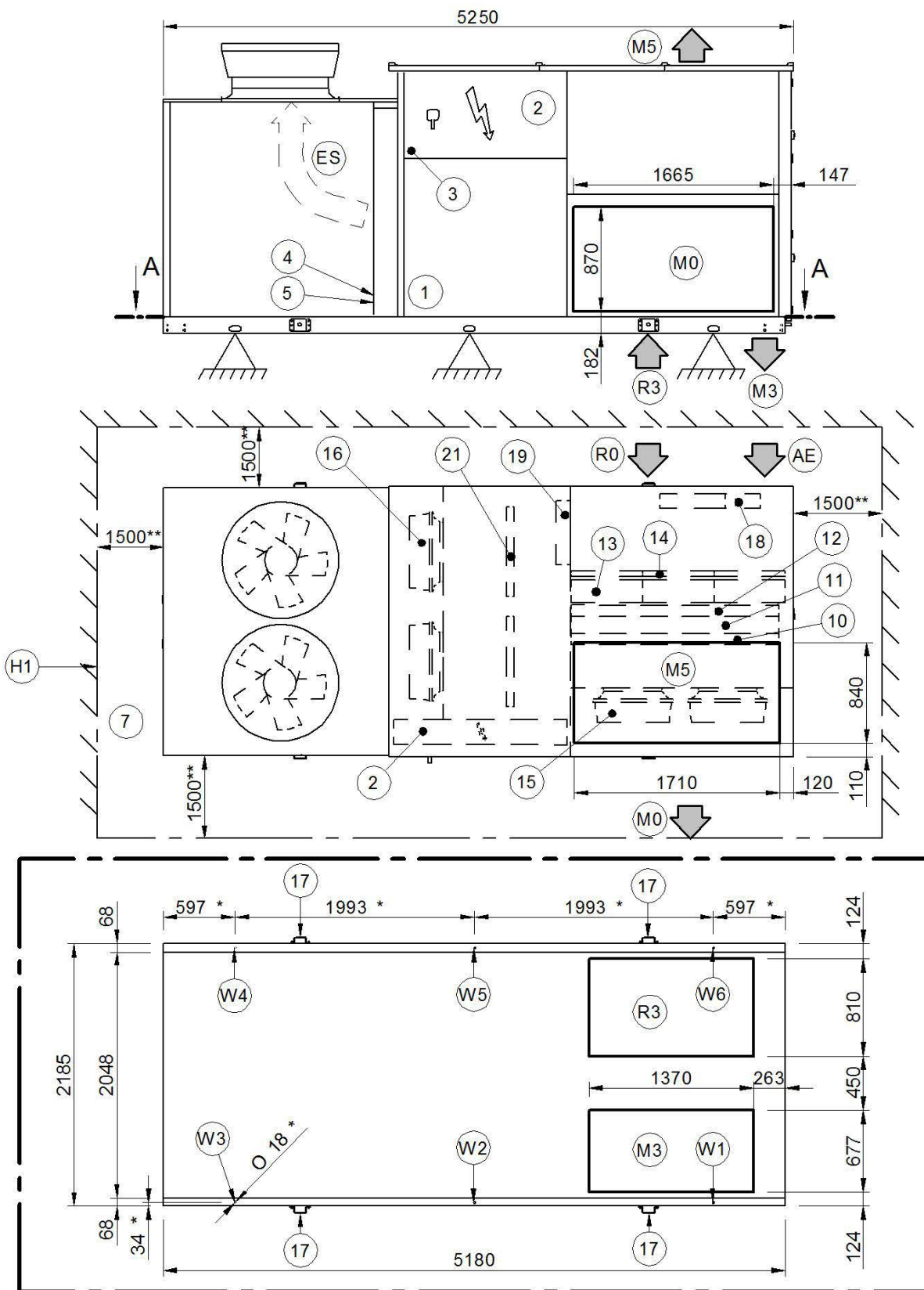

Sez A-A

Size 49.4 - 54.4 Combustion module

Single chamber (GC09X 65 kW - GC10X 82 kW - GC11X 100 kW) (GD14X 74kW - GD15X 100 kW)

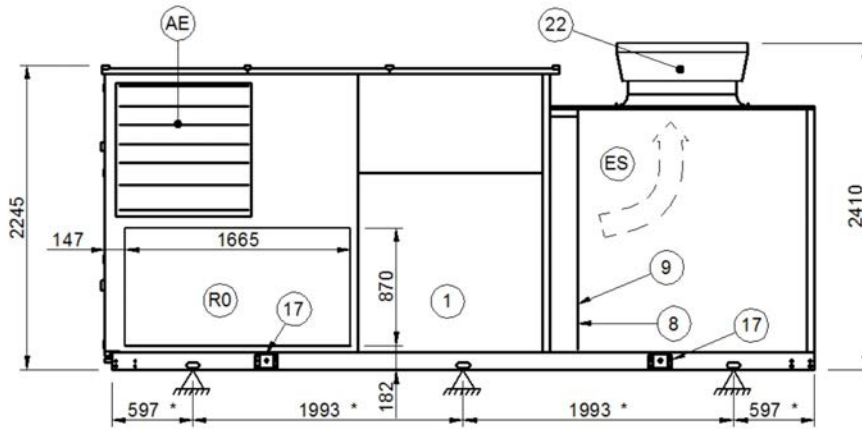

- | | |
|--|--|
| 1. Compressor compartment | 15. Electric fan (supply - return) |
| 2. Electrical panel | 16. Exhaust electric fan (CCK - CCKP version) |
| 3. Connector for keyboard or PC connection | 17. Lifting brackets (removable) |
| 4. Power input | 18. Outdoor air damper |
| 5. Humidifier connections | 19. Exhaust overpressure damper (CCK - CCKP version) |
| 6. Condensate drain | 20. Access for coil - filter - heater inspection |
| 7. Functional spaces | 21. Exhaust air recovery coil (only CCKP version) |
| 8. Water heating coil inlet Ø 1" 1/2 | 22. Axitop (removable) |
| 9. Water heating coil outlet Ø 1" 1/2 | 23. Gas module (to be connected to the unit during installation) |
| 10. Reheat coil (optional) | (R0) Horizontal air return |
| 11. Treatment coil | (R3) Downward air return (optional) |
| 12. Water heating coil (optional) | (M0) Horizontal air supply |
| 13. F7 / Electronic filters (optional) | (AE) Outdoor air intake |
| 14. Standard G4 filters | (ES) Exhaust air (CCK - CCKP version) |
| | (H1) Wall with same height as unit on a maximum of three sides |
| | (*) Anti-vibration mount position |
| | (**) Suggested minimum clearance |

WEIGHT DISTRIBUTION

Size	kg	49.4			54.4		
		CAK/CBK	CCK	CCKP	CAK/CBK	CCK	CCKP
W1 Supporting point	kg	427	449	468	490	512	531
W2 Supporting point	kg	383	403	420	440	460	477
W3 Supporting point	kg	317	334	348	364	381	395
W4 Supporting point	kg	317	334	348	364	381	395
W5 Supporting point	kg	350	369	384	402	420	436
W6 Supporting point	kg	394	415	432	452	473	490
Operating weight	kg	2189	2304	2400	2512	2628	2724
Shipping weight	kg	2189	2304	2400	2512	2628	2724

GAS MODULE WEIGHT DISTRIBUTION

Size		49.4	54.4
W7 Supporting point	kg	75	75
W8 Supporting point	kg	65	65
W9 Supporting point	kg	65	65
W10 Supporting point	kg	75	75
Operating weight	kg	280	280
Shipping weight	kg	280	280

The presence of optional accessories may result in a substantial variation of the weights shown in the table.

Size 49.4 - 54.4 Combustion module

DAA7V49 4_54 4_GC09X_GC11X_00

Date: 28/04/2016

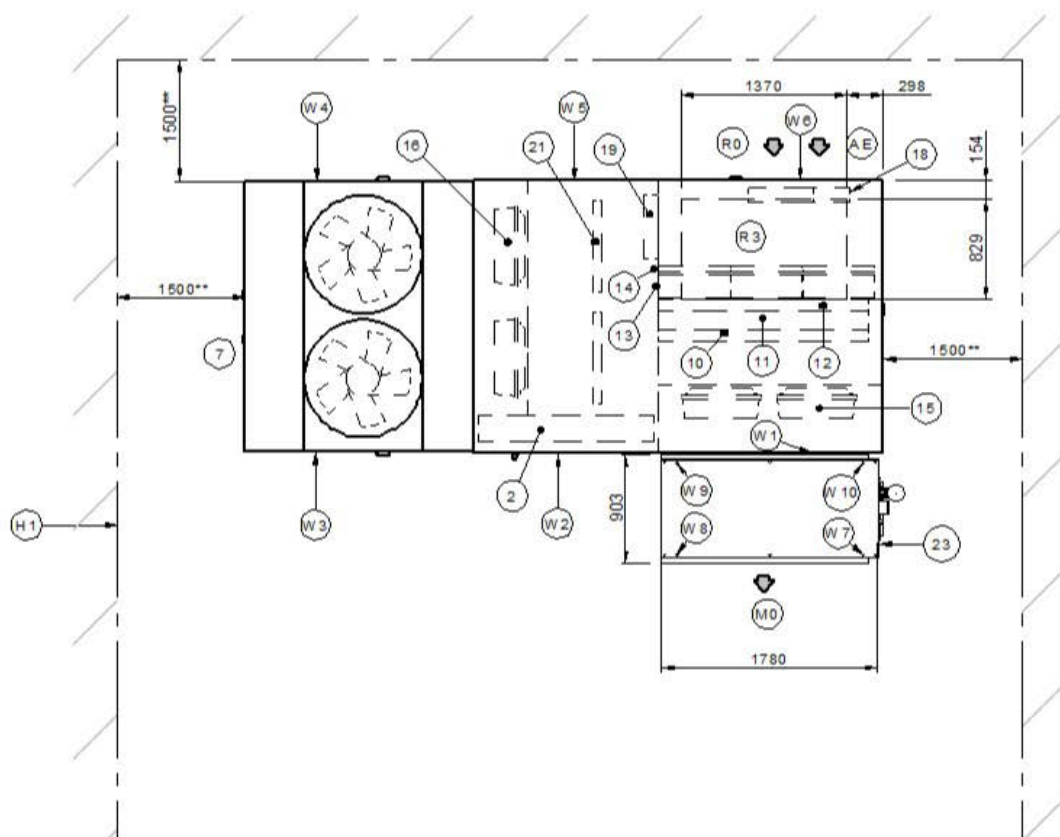
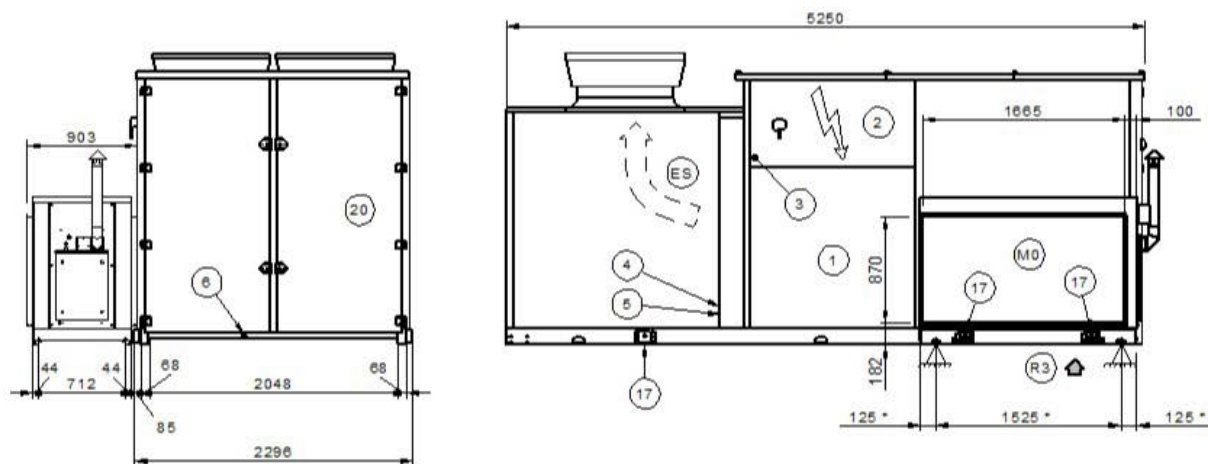

Size 49.4 - 54.4 Combustion module

Double chamber (GC12X 130 kW) (GD16X 147kW)

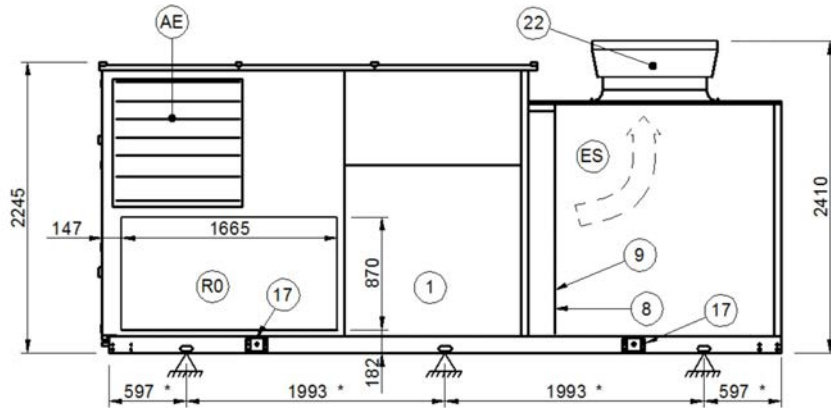

- | | |
|--|--|
| 1. Compressor compartment | 15. Electric fan (supply - return) |
| 2. Electrical panel | 16. Exhaust electric fan (CCK - CCKP version) |
| 3. Connector for keyboard or PC connection | 17. Lifting brackets (removable) |
| 4. Power input | 18. Outdoor air damper |
| 5. Humidifier connections | 19. Exhaust overpressure damper (CCK - CCKP version) |
| 6. Condensate drain | 20. Access for coil - filter - heater inspection |
| 7. Functional spaces | 21. Exhaust air recovery coil (only CCKP version) |
| 8. Water heating coil inlet Ø 1" 1/2 | 22. Axitop (removable) |
| 9. Water heating coil outlet Ø 1" 1/2 | 23. Gas module (to be connected to the unit during installation) |
| 10. Reheat coil (optional) | (R0) Horizontal air return |
| 11. Treatment coil | (R3) Downward air return (optional) |
| 12. Water heating coil (optional) | (M0) Horizontal air supply |
| 13. F7 / Electronic filters (optional) | (AE) Outdoor air intake |
| 14. Standard G4 filters | (ES) Exhaust air (CCK - CCKP version) |
| | (H1) Wall with same height as unit on a maximum of three sides |
| | (*) Anti-vibration mount position |
| | (**) Suggested minimum clearance |

WEIGHT DISTRIBUTION

Size	kg	49.4			54.4		
		CAK/CBK	CCK	CCKP	CAK/CBK	CCK	CCKP
W1 Supporting point	kg	427	449	468	490	512	531
W2 Supporting point	kg	383	403	420	440	460	477
W3 Supporting point	kg	317	334	348	364	381	395
W4 Supporting point	kg	317	334	348	364	381	395
W5 Supporting point	kg	350	369	384	402	420	436
W6 Supporting point	kg	394	415	432	452	473	490
Operating weight	kg	2189	2304	2400	2512	2628	2724
Shipping weight	kg	2189	2304	2400	2512	2628	2724

GAS MODULE WEIGHT DISTRIBUTION

Size		49.4	54.4
W7 Supporting point	kg	100	100
W8 Supporting point	kg	75	75
W9 Supporting point	kg	75	75
W10 Supporting point	kg	100	100
Operating weight	kg	350	350
Shipping weight	kg	350	350

The presence of optional accessories may result in a substantial variation of the weights shown in the table.

Size 49.4 - 54.4 Combustion module

DAA7V49 4_54 4_GC12X_00

Date: 28/04/2016

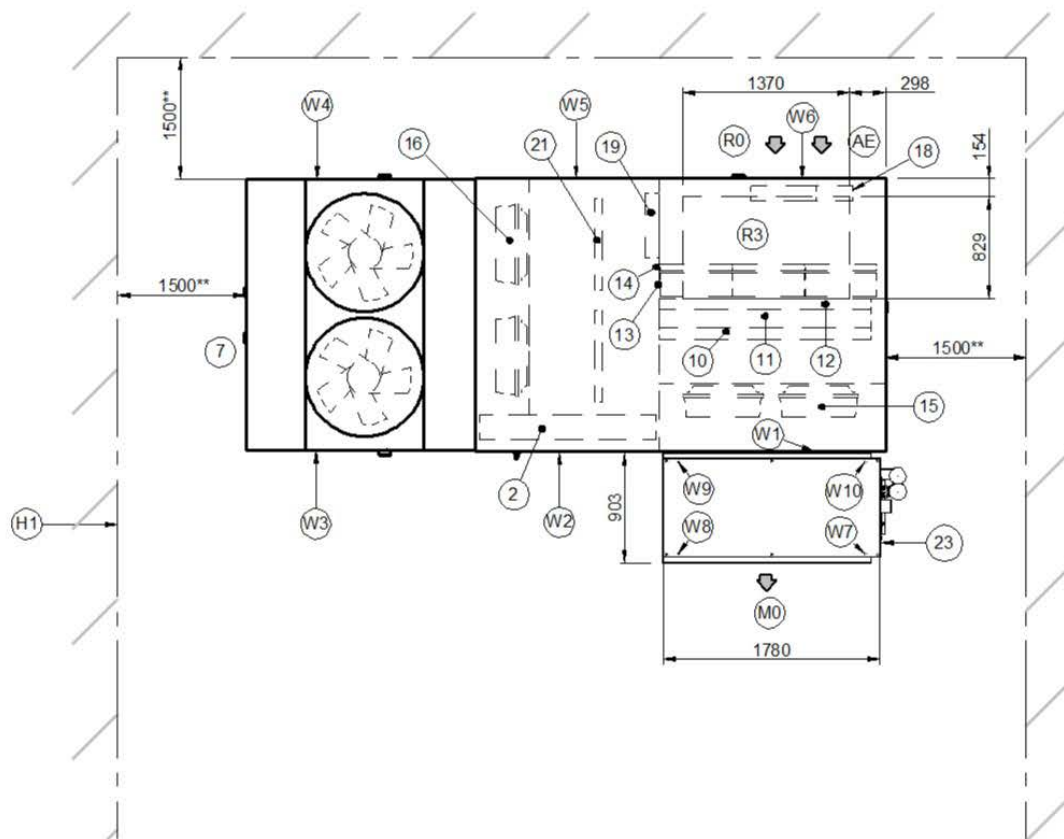
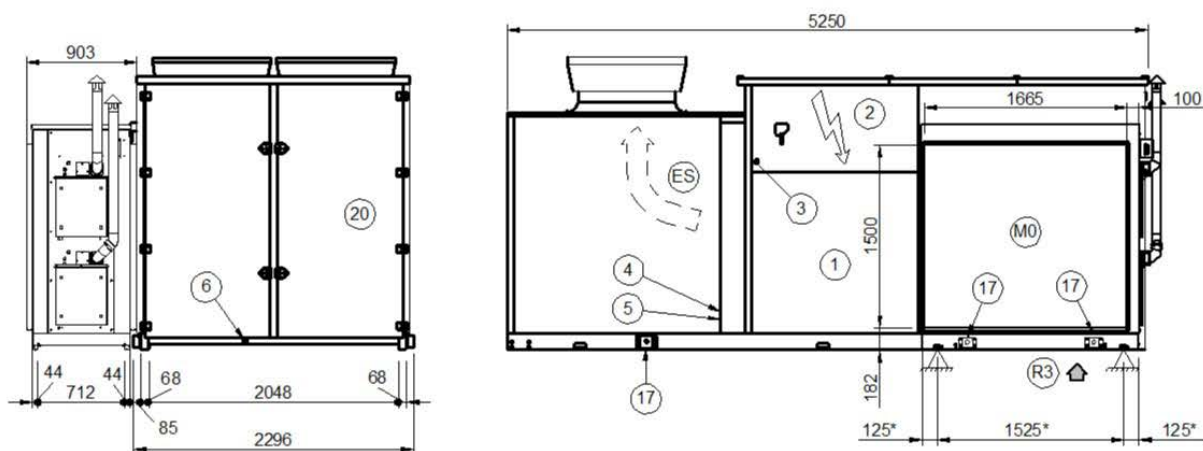

Size 60.4 - 70.4 - 80.4

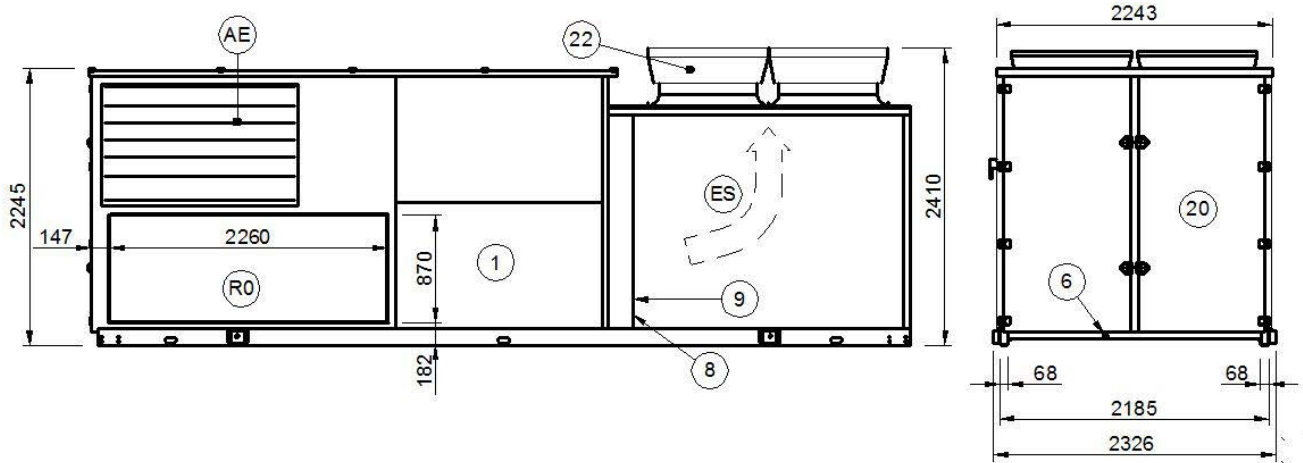

- | | |
|---|---|
| <ul style="list-style-type: none"> 1. Compressor compartment 2. Electrical panel 3. Connector for keyboard or PC connection 4. Power input 5. Humidifier connections 6. Condensate drain 7. Functional spaces 8. Water heating coil inlet Ø 2" 9. Water heating coil outlet Ø 2" 10. Reheat coil (optional) 11. Treatment coil 12. Water heating coil (optional) 13. F7 / Electronic filters (optional) 14. Standard G4 filters 15. Electric fan (supply - return) | <ul style="list-style-type: none"> 16. Exhaust electric fan (CCK - CCKP version) 17. Lifting brackets (removable) 18. Outdoor air damper 19. Exhaust overpressure damper (CCK - CCKP version) 20. Access for coil - filter - heater inspection 21. Exhaust air recovery coil (only CCKP version) 22. Axitop (removable) <p>(R0) Horizontal air return
 (R3) Downward air return (optional)
 (M0) Horizontal air supply
 (M3) Downward air supply (optional)
 (M5) Upflow air supply
 (AE) Outdoor air intake
 (ES) Exhaust air (CCK - CCKP version)
 (H1) Wall with same height as unit on a maximum of three sides
 (*) Anti-vibration mount position
 (**) Suggested minimum clearance</p> |
|---|---|

WEIGHT DISTRIBUTION

Size	kg	60.4			70.4			80.4		
		CAK/CBK	CCK	CCKP	CAK/CBK	CCK	CCKP	CAK/CBK	CCK	CCKP
W1 Supporting point	kg	524	554	578	562	591	616	644	674	699
W2 Supporting point	kg	470	497	519	504	530	553	578	605	627
W3 Supporting point	kg	390	412	430	418	440	458	479	501	520
W4 Supporting point	kg	390	412	430	418	440	458	479	501	520
W5 Supporting point	kg	430	454	475	461	485	505	529	553	573
W6 Supporting point	kg	484	511	534	518	546	568	595	622	645
Operating weight	kg	2688	2839	2966	2880	3031	3158	3305	3457	3583
Shipping weight	kg	2688	2839	2966	2880	3031	3158	3305	3457	3583

The presence of optional accessories may result in a substantial variation of the weights shown in the table.

Size 60.4 - 70.4 - 80.4

DAA7V60 4_80 4_02

Date: 23/09/2014

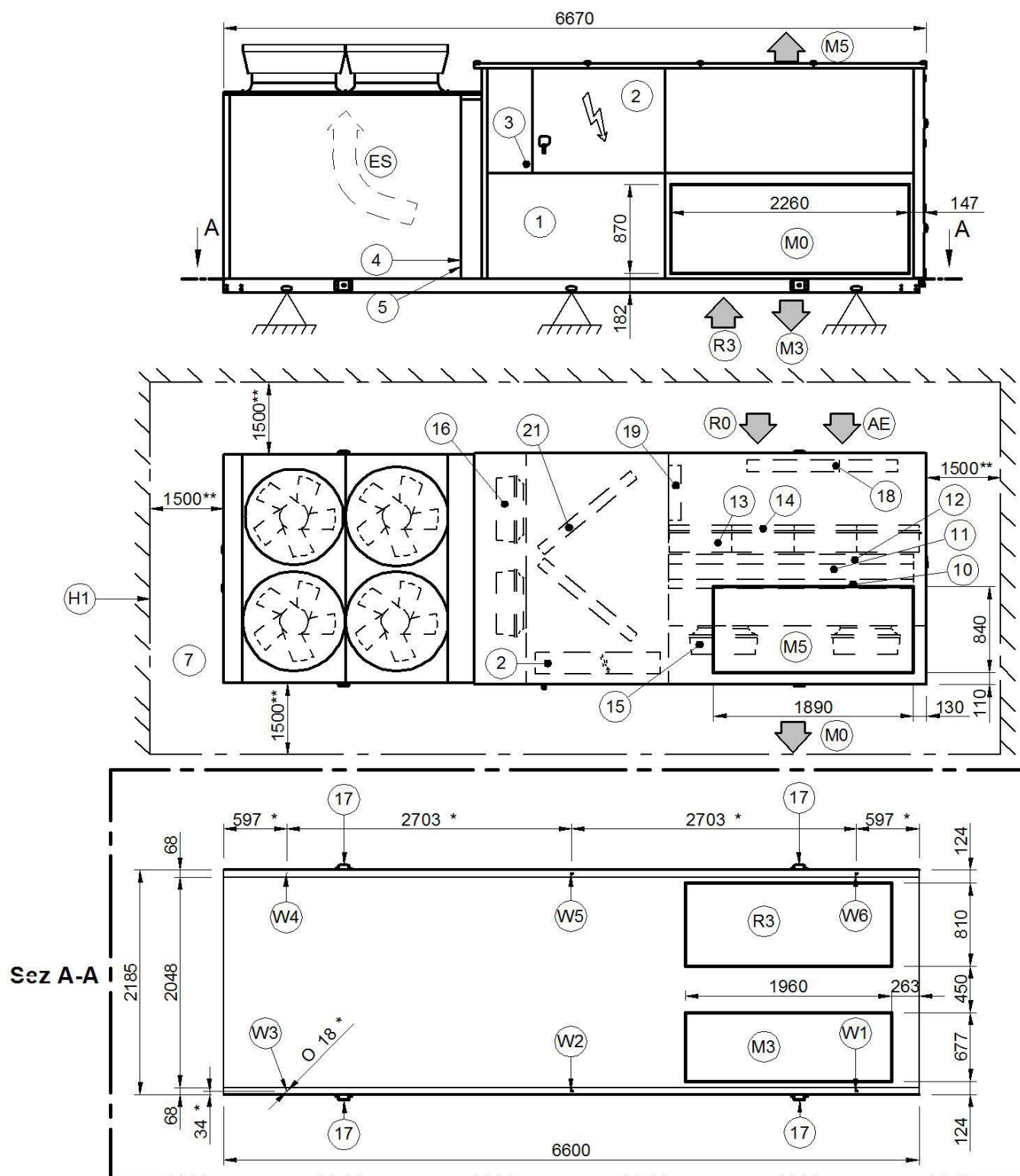

Size 60.4 - 70.4 - 80.4 Combustion module

Single chamber (GC10X 82 kW - GC11X 100 kW) (GD15X 100kW)

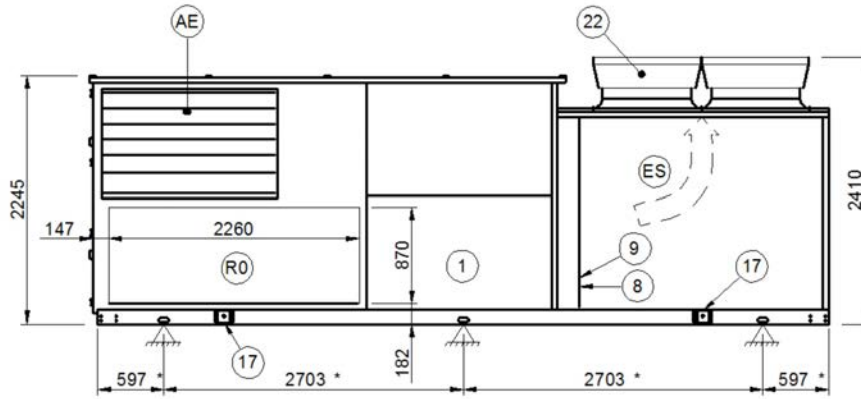

- | | |
|--|--|
| 1. Compressor compartment | 15. Electric fan (supply - return) |
| 2. Electrical panel | 16. Exhaust electric fan (CBK - CCK - CCKP version) |
| 3. Connector for keyboard or PC connection | 17. Lifting brackets (removable) |
| 4. Power input | 18. Outdoor air damper |
| 5. Humidifier connections | 19. Exhaust overpressure damper (CCK - CCKP version) |
| 6. Condensate drain | 20. Access for coil - filter - heater inspection |
| 7. Functional spaces | 21. Exhaust air recovery coil (only CCKP version) |
| 8. Water heating coil inlet Ø 2" | 22. Axitop (removable) |
| 9. Water heating coil outlet Ø 2" | 23. Gas module (to be connected to the unit during installation) |
| 10. Reheat coil (optional) | (R0) Horizontal air return |
| 11. Treatment coil | (R3) Downward air return (optional) |
| 12. Water heating coil (optional) | (M0) Horizontal air supply |
| 13. F7 / Electronic filters (optional) | (AE) Outdoor air intake |
| 14. Standard G4 filters | (ES) Exhaust air (CCK - CCKP version) |
| | (H1) Wall with same height as unit on a maximum of three sides |
| | (*) Anti-vibration mount position |
| | (**) Suggested minimum clearance |

WEIGHT DISTRIBUTION

Size		60.4			70.4			80.4		
Configuration	kg	CAK/CBK	CCK	CCKP	CAK/CBK	CCK	CCKP	CAK/CBK	CCK	CCKP
W1 Supporting point	kg	524	554	578	562	591	616	644	674	699
W2 Supporting point	kg	470	497	519	504	530	553	578	605	627
W3 Supporting point	kg	390	412	430	418	440	458	479	501	520
W4 Supporting point	kg	390	412	430	418	440	458	479	501	520
W5 Supporting point	kg	430	454	475	461	485	505	529	553	573
W6 Supporting point	kg	484	511	534	518	546	568	595	622	645
Operating weight	kg	2688	2839	2966	2880	3031	3158	3305	3457	3583
Shipping weight	kg	2688	2839	2966	2880	3031	3158	3305	3457	3583

GAS MODULE WEIGHT DISTRIBUTION

Size		60.4	70.4	80.4
W7 Supporting point	kg	85	85	85
W8 Supporting point	kg	75	75	75
W9 Supporting point	kg	75	75	75
W10 Supporting point	kg	85	85	85
Operating weight	kg	320	320	320
Shipping weight	kg	320	320	320

The presence of optional accessories may result in a substantial variation of the weights shown in the table.

Size 60.4 - 70.4 - 80.4 Combustion module

DAA7V60 4_80 4_GC10X_GC11X_00

Date: 28/04/2016

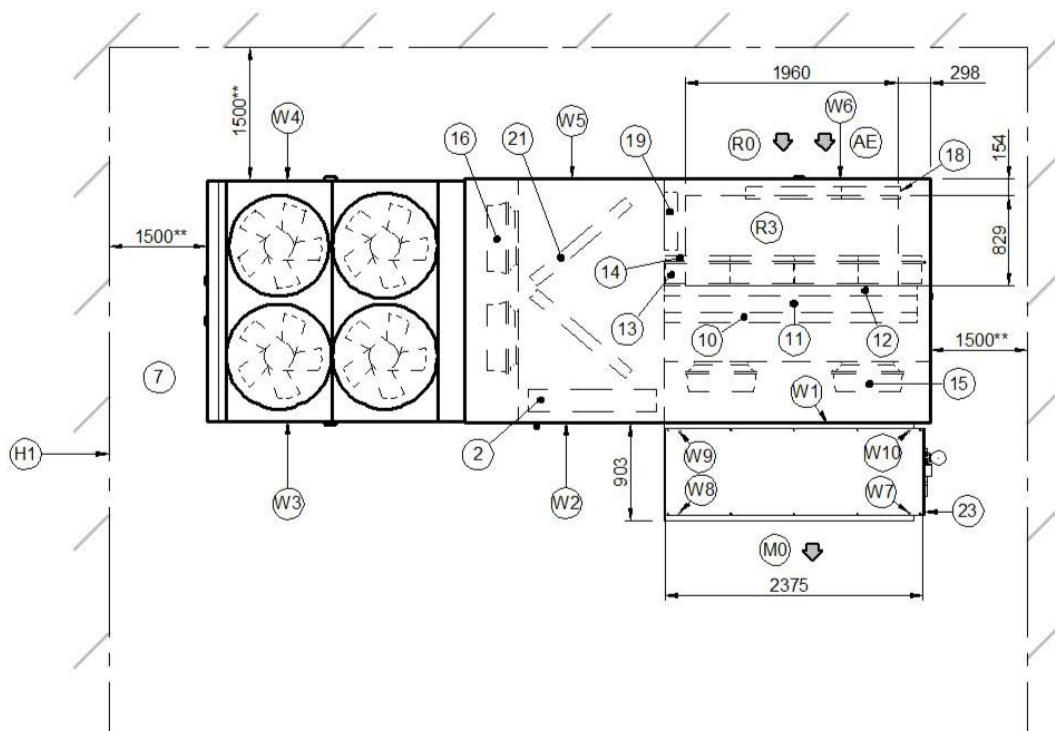
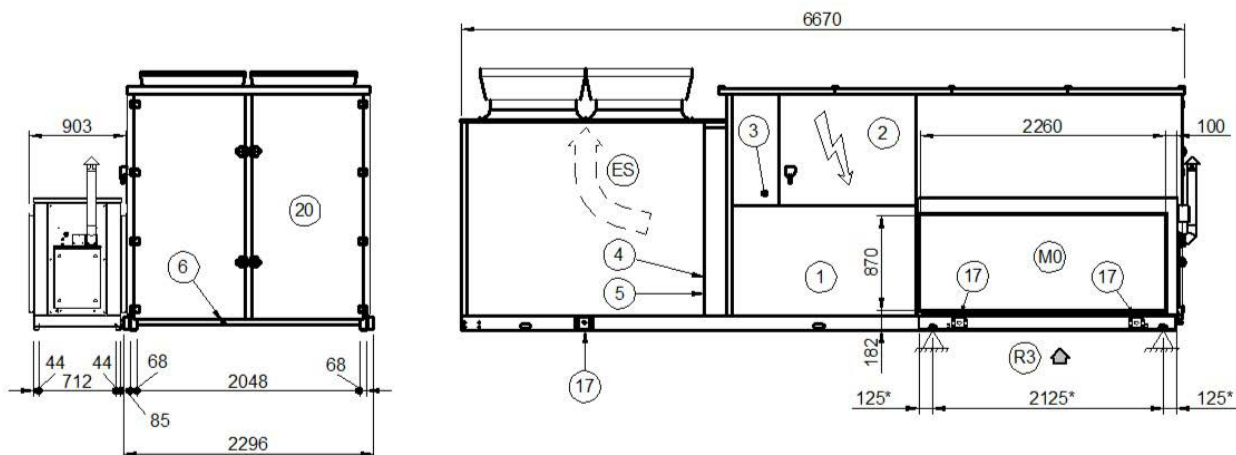

Size 60.4 - 70.4 - 80.4 Combustion module

Double chamber (GC13X 164 kW - GC06X 200 kW) (GD16X 147kW - GD17X 200 kW)

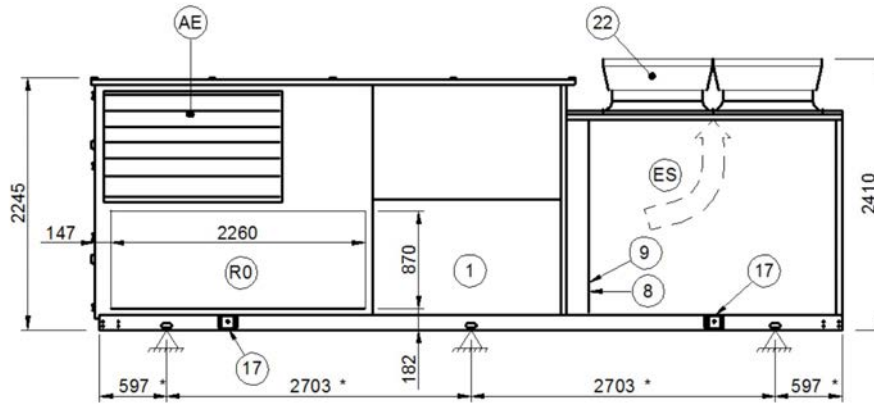

- | | |
|--|--|
| 1. Compressor compartment | 15. Electric fan (supply - return) |
| 2. Electrical panel | 16. Exhaust electric fan (CBK - CCK - CCKP version) |
| 3. Connector for keyboard or PC connection | 17. Lifting brackets (removable) |
| 4. Power input | 18. Outdoor air damper |
| 5. Humidifier connections | 19. Exhaust overpressure damper (CCK - CCKP version) |
| 6. Condensate drain | 20. Access for coil - filter - heater inspection |
| 7. Functional spaces | 21. Exhaust air recovery coil (only CCKP version) |
| 8. Water heating coil inlet Ø 2" | 22. Axitop (removable) |
| 9. Water heating coil outlet Ø 2" | 23. Gas module (to be connected to the unit during installation) |
| 10. Reheat coil (optional) | (R0) Horizontal air return |
| 11. Treatment coil | (R3) Downward air return (optional) |
| 12. Water heating coil (optional) | (M0) Horizontal air supply |
| 13. F7 / Electronic filters (optional) | (AE) Outdoor air intake |
| 14. Standard G4 filters | (ES) Exhaust air (CCK - CCKP version) |
| | (H1) Wall with same height as unit on a maximum of three sides |
| | (*) Anti-vibration mount position |
| | (**) Suggested minimum clearance |

WEIGHT DISTRIBUTION

Size	kg	60.4			70.4			80.4		
		CAK/CBK	CCK	CCKP	CAK/CBK	CCK	CCKP	CAK/CBK	CCK	CCKP
W1 Supporting point	kg	524	554	578	562	591	616	644	674	699
W2 Supporting point	kg	470	497	519	504	530	553	578	605	627
W3 Supporting point	kg	390	412	430	418	440	458	479	501	520
W4 Supporting point	kg	390	412	430	418	440	458	479	501	520
W5 Supporting point	kg	430	454	475	461	485	505	529	553	573
W6 Supporting point	kg	484	511	534	518	546	568	595	622	645
Operating weight	kg	2688	2839	2966	2880	3031	3158	3305	3457	3583
Shipping weight	kg	2688	2839	2966	2880	3031	3158	3305	3457	3583

GAS MODULE WEIGHT DISTRIBUTION

Size	kg	60.4	70.4	80.4
W7 Supporting point	kg	145	145	145
W8 Supporting point	kg	100	100	100
W9 Supporting point	kg	145	145	145
W10 Supporting point	kg	100	100	100
Operating weight	kg	490	490	490
Shipping weight	kg	490	490	490

The presence of optional accessories may result in a substantial variation of the weights shown in the table.

Size 60.4 - 70.4 - 80.4 Combustion module

DAA7V60 4_80 4_GC13X_GC06X_00

Date: 28/04/2016

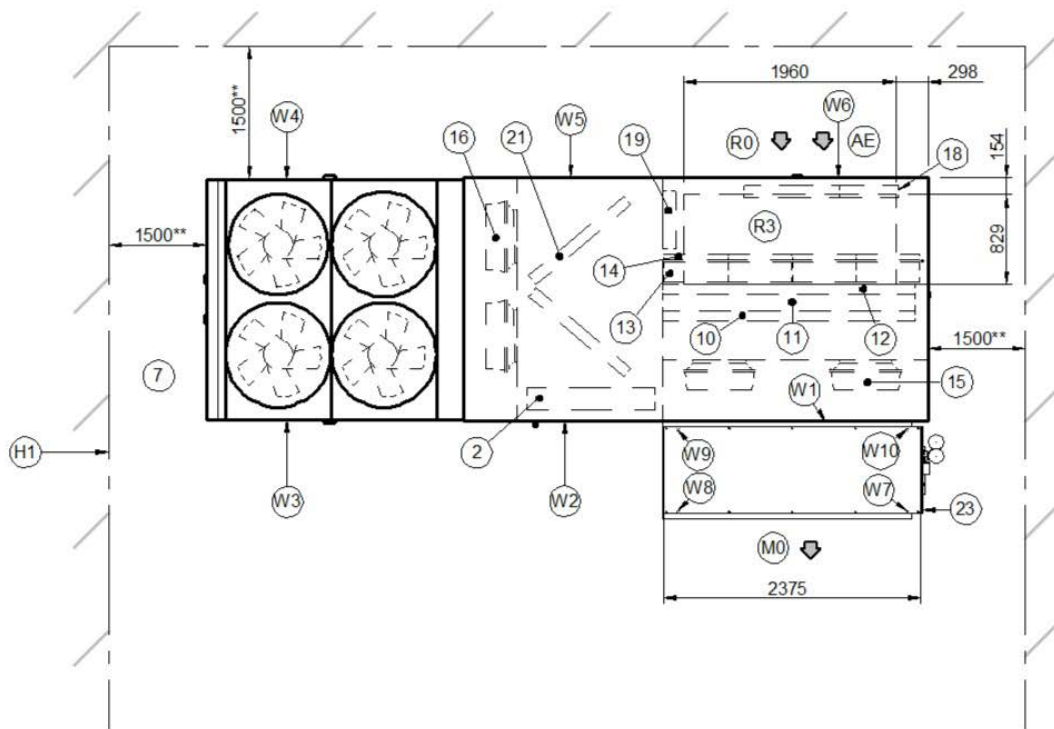
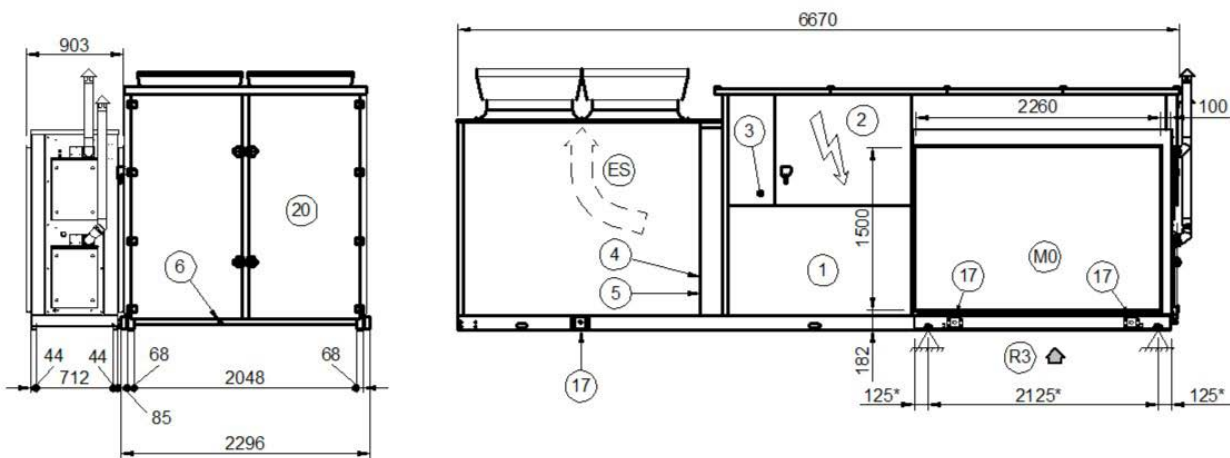

Size 90.4 - 100.4 - 110.4

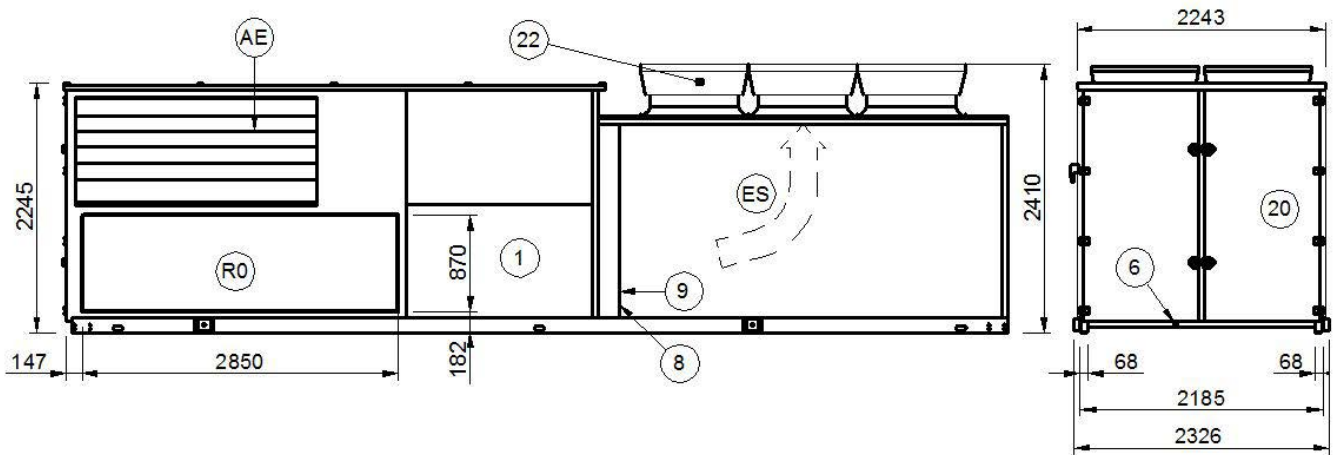

- 1. Compressor compartment
 - 2. Electrical panel
 - 3. Connector for keyboard or PC connection
 - 4. Power input
 - 5. Humidifier connections
 - 6. Condensate drain
 - 7. Functional spaces
 - 8. Water heating coil inlet Ø 2"
 - 9. Water heating coil outlet Ø 2"
 - 10. Reheat coil (optional)
 - 11. Treatment coil
 - 12. Water heating coil (optional)
 - 13. F7 / Electronic filters (optional)
 - 14. Standard G4 filters
 - 15. Electric fan (supply - return)
 - 16. Exhaust electric fan (CCK - CCKP version)
 - 17. Lifting brackets (removable)
 - 18. Outdoor air damper
 - 19. Exhaust overpressure damper (CCK - CCKP version)
 - 20. Access for coil - filter - heater inspection
 - 21. Exhaust air recovery coil (only CCKP version)
 - 22. Axitop (removable)
- (R0) Horizontal air return
 (R3) Downward air return
 (M0) Horizontal air supply
 (M3) Downward air supply (optional)
 (M5) Upflow air supply
 (AE) Outdoor air intake
 (ES) Exhaust air (CCK - CCKP version)
 (H1) Wall with same height as unit on a maximum of three sides
 (*) Anti-vibration mount position
 (**) Suggested minimum clearance

WEIGHT DISTRIBUTION

Size		90.4			100.4			110.4		
Configuration	kg	CAK/CBK	CCK	CCKP	CAK/CBK	CCK	CCKP	CAK/CBK	CCK	CCKP
W1 Supporting point	kg	669	706	738	717	754	786	822	860	891
W2 Supporting point	kg	600	634	662	643	677	705	738	772	800
W3 Supporting point	kg	497	525	549	533	561	584	611	640	663
W4 Supporting point	kg	497	525	549	533	561	584	611	640	663
W5 Supporting point	kg	549	580	605	588	619	645	675	706	731
W6 Supporting point	kg	617	652	681	661	696	725	759	794	823
Operating weight	kg	3430	3622	3784	3674	3867	4029	4217	4411	4571
Shipping weight	kg	3430	3622	3784	3674	3867	4029	4217	4411	4571

The presence of optional accessories may result in a substantial variation of the weights shown in the table.

Size 90.4 - 100.4 - 110.4

DAA7V90 4_110 4_03
Date: 15/04/2016

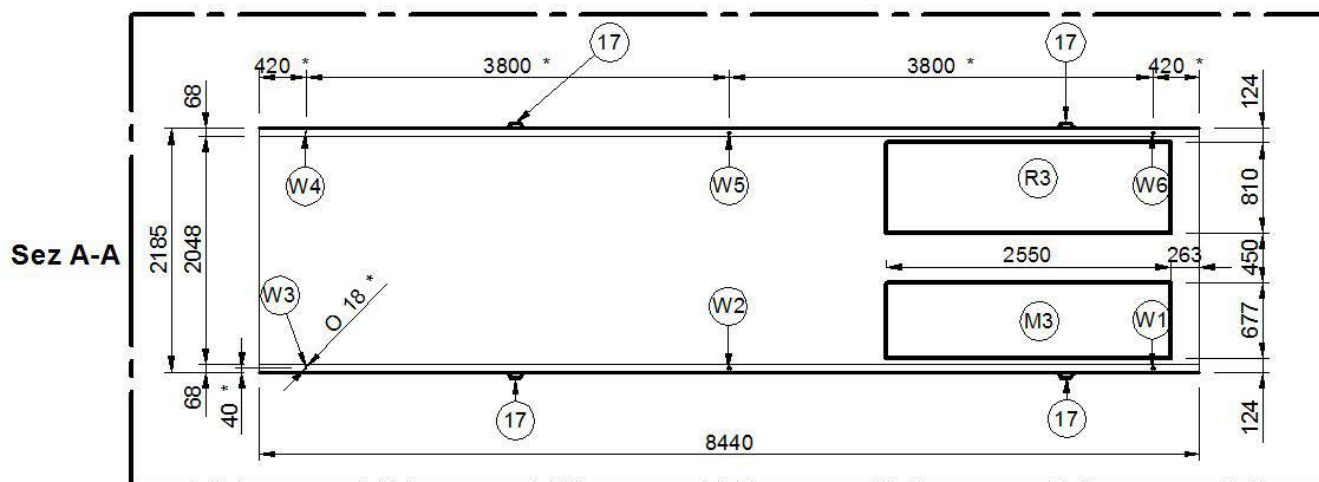
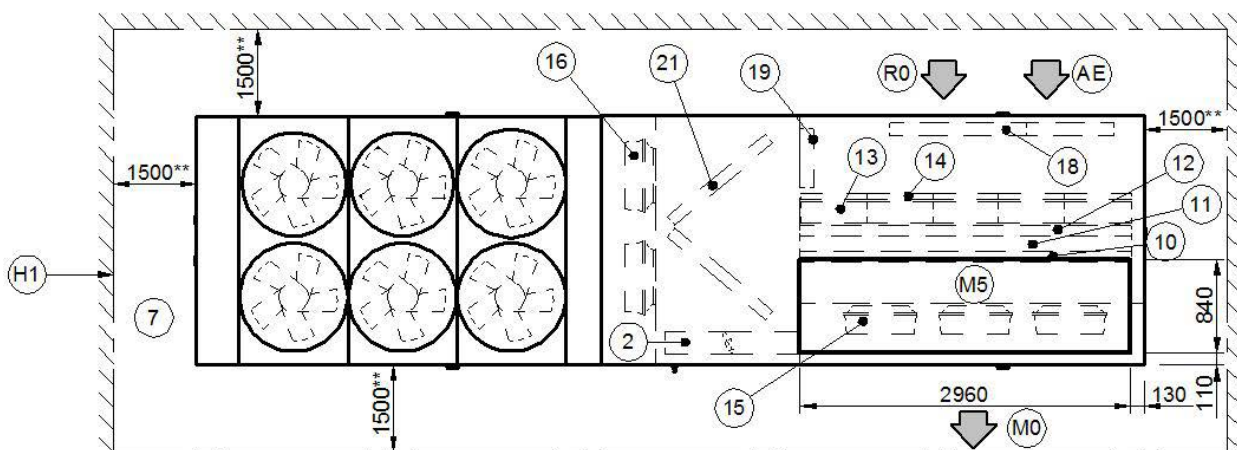
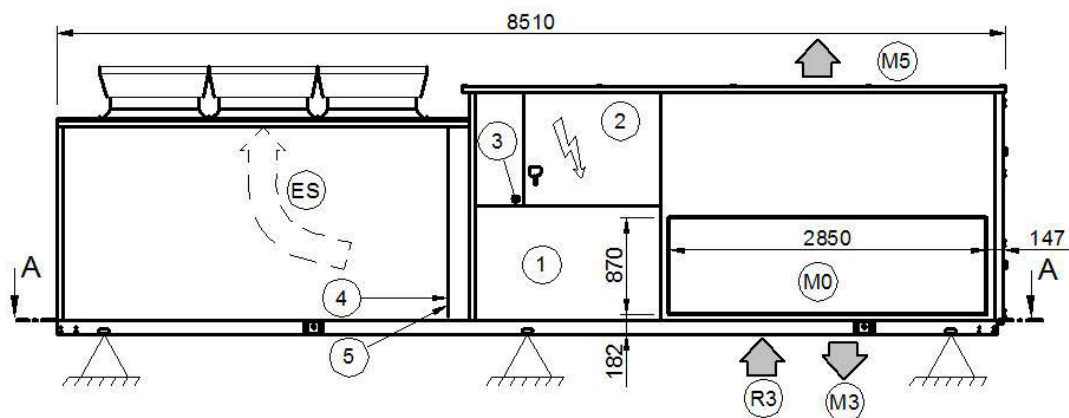

Size 90.4 - 100.4 - 110.4 Combustion module

Double chamber (GC12X 130 kW - GC13X 1640 kW - GC06X 200 kW) (GD16X 147kW - GD17X 200 kW)

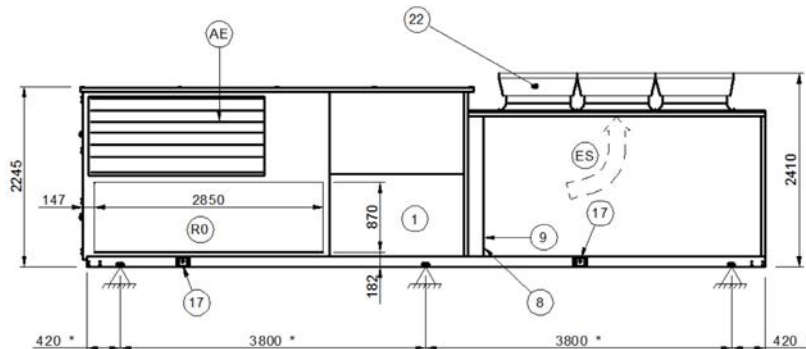

- | | |
|---|--|
| <ol style="list-style-type: none"> 1. Compressor compartment 2. Electrical panel 3. Connector for keyboard or PC connection 4. Power input 5. Humidifier connections 6. Condensate drain 7. Functional spaces 8. Water heating coil inlet Ø 2" 9. Water heating coil outlet Ø 2" 10. Reheat coil (optional) 11. Treatment coil 12. Water heating coil (optional) 13. F7 / Electronic filters (optional) 14. Standard G4 filters | <ol style="list-style-type: none"> 15. Electric fan (supply - return) 16. Exhaust electric fan (CCK - CCKP version) 17. Lifting brackets (removable) 18. Outdoor air damper 19. Exhaust overpressure damper (CCK - CCKP version) 20. Access for coil - filter - heater inspection 21. Exhaust air recovery coil (only CCKP version) 22. Axitop (removable) 23. Gas module (to be connected to the unit during installation) <p>(R0) Horizontal air return
 (R3) Downward air return (optional)
 (M0) Horizontal air supply
 (AE) Outdoor air intake
 (ES) Exhaust air (CCK - CCKP version)
 (H1) Wall with same height as unit on a maximum of three sides
 (*) Anti-vibration mount position
 (**) Suggested minimum clearance</p> |
|---|--|

WEIGHT DISTRIBUTION

Size	90.4			100.4			110.4			
Configuration	kg	CAK/CBK	CCK	CCKP	CAK/CBK	CCK	CCKP	CAK/CBK	CCK	CCKP
W1 supporting point	kg	669	706	738	717	754	786	822	860	891
W2 Supporting point	kg	600	634	662	643	677	705	738	772	800
W3 Supporting point	kg	497	525	549	533	561	584	611	640	663
W4 Supporting point	kg	497	525	549	533	561	584	611	640	663
W5 Supporting point	kg	549	580	605	588	619	645	675	706	731
W6 Supporting point	kg	617	652	681	661	696	725	759	794	823
Operating weight	kg	3430	3622	3784	3674	3867	4029	4217	4411	4571
Shipping weight	kg	3430	3622	3784	3674	3867	4029	4217	4411	4571

GAS MODULE WEIGHT DISTRIBUTION

Size	90.4	100.4	110.4	
W7 Supporting point	kg	155	155	155
W8 Supporting point	kg	110	110	110
W9 Supporting point	kg	110	110	110
W10 Supporting point	kg	155	155	155
Operating weight	kg	530	530	530
Shipping weight	kg	530	530	530

The presence of optional accessories may result in a substantial variation of the weights shown in the table.

Size 90.4 - 100.4 - 110.4 Combustion module

DAA7V90 4_110 4_GC13X_GC06X_01

Date: 28/04/2016

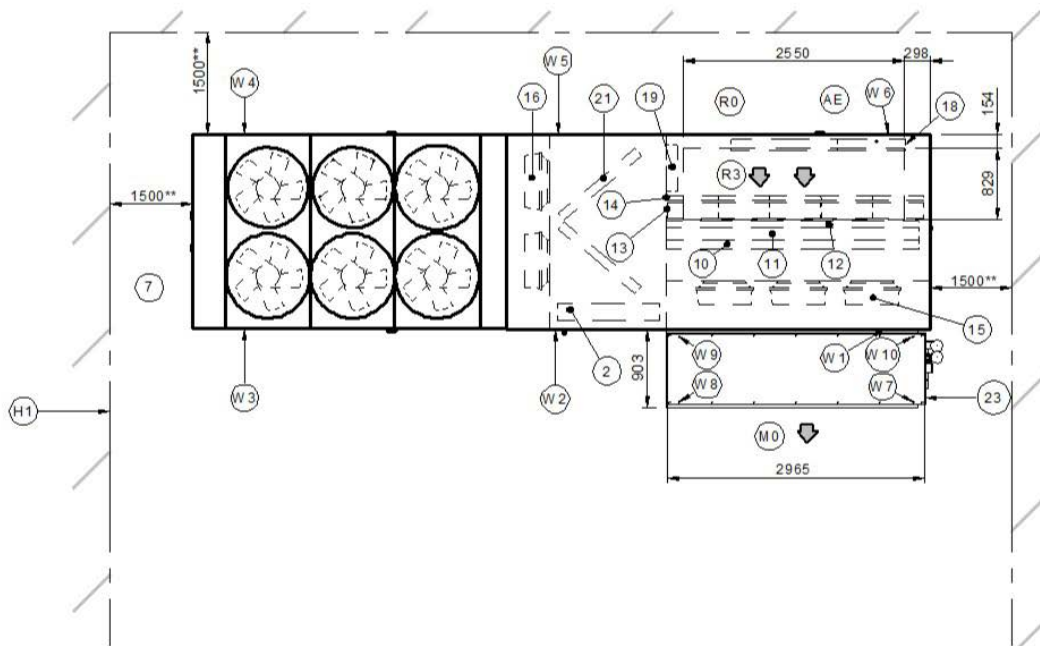
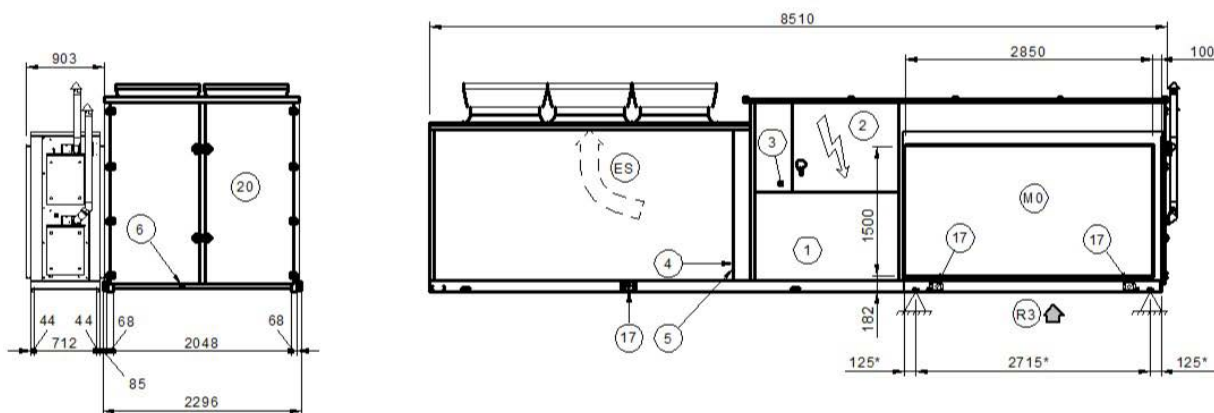

Size 90.4 - 100.4 - 110.4 Combustion module

Triple chamber (GC07X 300 kW) (GD18X 300 kW)

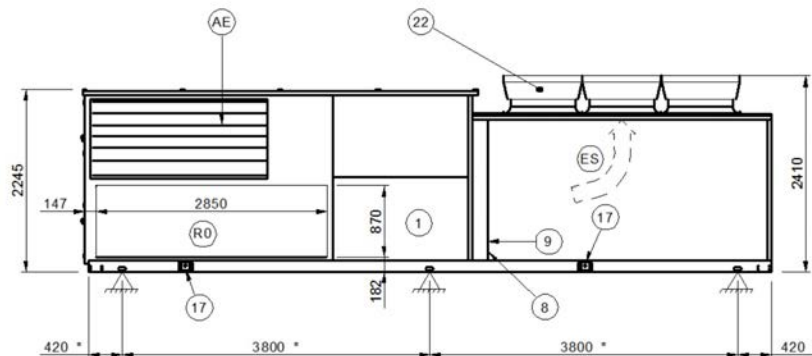

- | | |
|--|--|
| 1. Compressor compartment | 15. Electric fan (supply - return) |
| 2. Electrical panel | 16. Exhaust electric fan (CCK - CCKP version) |
| 3. Connector for keyboard or PC connection | 17. Lifting brackets (removable) |
| 4. Power input | 18. Outdoor air damper |
| 5. Humidifier connections | 19. Exhaust overpressure damper (CCK - CCKP version) |
| 6. Condensate drain | 20. Access for coil - filter - heater inspection |
| 7. Functional spaces | 21. Exhaust air recovery coil (only CCKP version) |
| 8. Water heating coil inlet Ø 2" | 22. Axitop (removable) |
| 9. Water heating coil outlet Ø 2" | 23. Gas module (to be connected to the unit during installation) |
| 10. Reheat coil (optional) | (R0) Horizontal air return |
| 11. Treatment coil | (R3) Downward air return (optional) |
| 12. Water heating coil (optional) | (M0) Horizontal air supply |
| 13. F7 / Electronic filters (optional) | (AE) Outdoor air intake |
| 14. Standard G4 filters | (ES) Exhaust air (CCK - CCKP version) |
| | (H1) Wall with same height as unit on a maximum of three sides |
| | (*) Anti-vibration mount position |
| | (**) Suggested minimum clearance |

WEIGHT DISTRIBUTION

Size	kg	90.4			100.4			110.4		
		CAK/CBK	CCK	CCKP	CAK/CBK	CCK	CCKP	CAK/CBK	CCK	CCKP
W1 supporting point	kg	669	706	738	717	754	786	822	860	891
W2 Supporting point	kg	600	634	662	643	677	705	738	772	800
W3 Supporting point	kg	497	525	549	533	561	584	611	640	663
W4 Supporting point	kg	497	525	549	533	561	584	611	640	663
W5 Supporting point	kg	549	580	605	588	619	645	675	706	731
W6 Supporting point	kg	617	652	681	661	696	725	759	794	823
Operating weight	kg	3430	3622	3784	3674	3867	4029	4217	4411	4571
Shipping weight	kg	3430	3622	3784	3674	3867	4029	4217	4411	4571

GAS MODULE WEIGHT DISTRIBUTION

Size		90.4	100.4	110.4
W7 Supporting point	kg	190	190	190
W8 Supporting point	kg	165	165	165
W9 Supporting point	kg	165	165	165
W10 Supporting point	kg	190	190	190
Operating weight	kg	710	710	710
Shipping weight	kg	710	710	710

The presence of optional accessories may result in a substantial variation of the weights shown in the table.

Size 90.4 - 100.4 - 110.4 Combustion module

DAA7V90 4_110 4_GC07X_01

Date: 28/04/2016

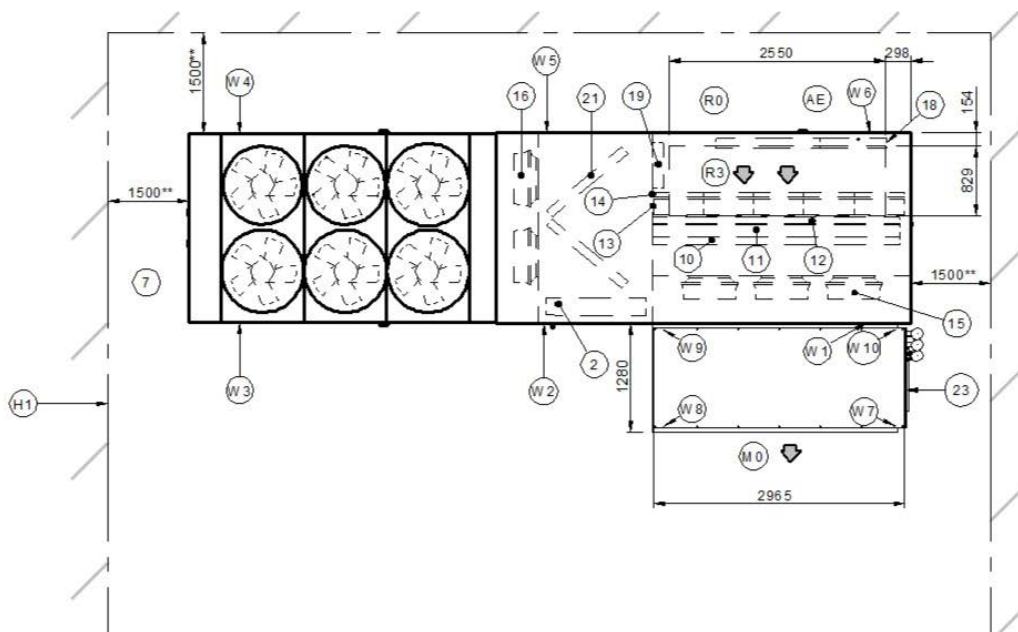
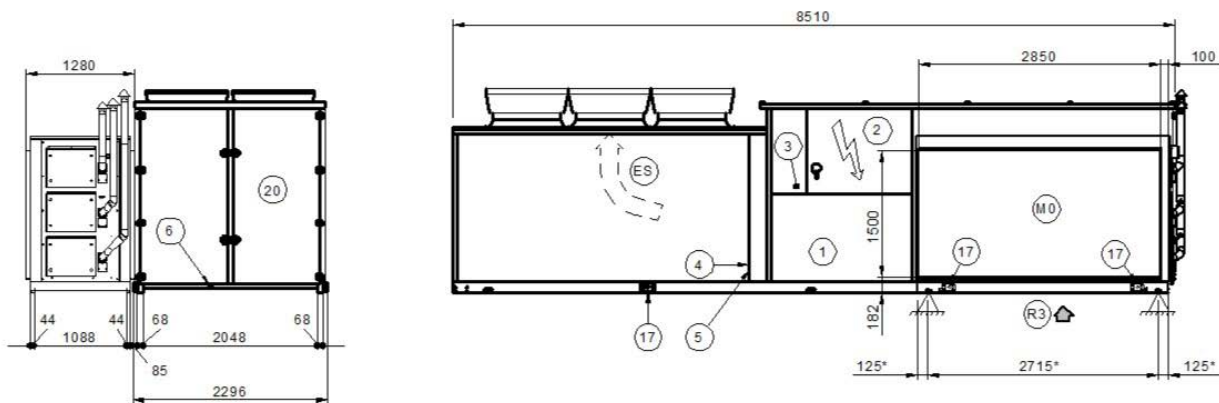

Page intentionally left blank

Page intentionally left blank

**CLIVET SPA**

Via Camp Lonc 25, Z.I. Villapaiera - 32032 Feltre (BL) - Italy
Tel. + 39 0439 3131 - Fax + 39 0439 313300 - info@clivet.it

CLIVET GROUP UK LIMITED

4 Kingdom Close, Segensworth East - Fareham, Hampshire - PO15 5TJ - United Kingdom
Tel. + 44 (0) 1489 572238 - Fax + 44 (0) 1489 573033 - enquiries@clivetgroup.co.uk

CLIVET GROUP UK Limited (Service Department)

Units F5&F6 Railway Triangle Ind Est, Walton Road - Portsmouth, Hampshire - PO6 1TG - United Kingdom
Tel. +44 (0) 2392 381235 - Fax. +44 (0) 2392 381243 - service@clivetgroup.co.uk

CLIVET ESPAÑA S.A.U.

C/ Bac de Roda, 36 - 08019 Barcelona - España
Tel: +34 93 8606248 - Fax +34 93 8855392 - info@clivet.es

Av.Manoteras Nº 38, Oficina C303 - 28050 Madrid - España
Tel. +34 91 6658280 - Fax +34 91 6657806 - info@clivet.es

CLIVET GmbH (Hydronic and Applied Division)

Hummelsbütteler Steindamm 84, 22851 Norderstedt - Germany
Tel. + 49 (0) 40 32 59 57-0 - Fax + 49 (0) 40 32 59 57-194 - info.de@clivet.com

CLIVET GmbH (VRF, Residential and Lightcom Division)

Eisenstrasse 9c, 65428 Rüsselsheim/Frankfurt - Germany
Tel. + 49 (0) 6142 83594-0 - Fax + 49 (0) 6142 83594-20 - vrf.de@clivet.com

CLIVET RUSSIA

Elektrozavodskaya st. 24, office 509 - 107023, Moscow, Russia
Tel. + 74956462009 - Fax + 74956462009 - info.ru@clivet.com

CLIVET MIDEAST FZCO

Dubai Silicon Oasis (DSO), High Bay Complex, Office N. 20, PO BOX 342009, Dubai, UAE
Tel. + 9714 3208499 - Fax + 9714 3208216 - info@clivet.ae

CLIVET AIRCONDITIONING SYSTEMS PRIVATE LIMITED

4BA, Gundecha Onclave, Kherani Road - Sakinaka, Andheri (East) - Mumbai 400 072 - India
Tel. +91 22 6193 7000 - Fax +91 22 6193 7001 - info.in@clivet.com

www.clivet.com
www.clivetlive.com

A Group Company of

