



Air cooled liquid chiller with multiscroll technology for outdoor installation

SPINchiller⁴

WSAT-YSC4 80.3 - 240.6 RANGE



TECHNICAL BULLETIN



SIZE - EXCELLENCE	80.3	100.4	115.4	130.4	155.5	170.5	185.5	210.6	225.6	240.6
COOLING CAPACITY [KW]	222	267	314	364	423	472	520	573	624	675
SIZE - PREMIUM	90.3	110.4	130.4	145.4	170.5	185.5	210.6	225.6	240.6	
COOLING CAPACITY [KW]	232	291	333	384	443	483	537	590	644	

Page

3	Features and benefits
4	Standard unit technical specifications
7	Unit configuration
8	Built-in options
11	Accessories separately supplied
12	General technical data
22	Performances
36	Configurations
43	Accessories - Hydronic assembly
55	Option compatibility
56	Dimensional drawings



Clivet is taking part in the EUROVENT certification programme up to 1.500 kW. The products concerned appear in the certified products list of the EUROVENT www.eurovent-certification.com site.

Features and benefits

SPINchiller⁴: Modular scroll technology for every application

SPINchiller⁴ is the new generation of Clivet liquid chillers and heat pump with modular scroll technology.

Thanks to its high seasonal efficiency and the adoption of the R-32 refrigerant with reduced environmental impact, it represents the ideal solution for different types of installation.

WSAT-YSC4

Air cooled water chiller with multiscroll technology

- EXCELLENCE / PREMIUM version
- Seasonal efficiency (SEER) 4,9 / 4,6
- Operating with 50°C of outdoor air temperature
- Operating with -18°C of outdoor air temperature
- Full aluminium microchannel coils
- Partial recovery of the condensing heat
- Total recovery of the condensing heat
- Plate exchangers / shell and tube



WSAN-YSC4

Air cooled heat pump with multiscroll technology

- EXCELLENCE / PREMIUM version
- Seasonal efficiency (SEER) 4,8 / 4,5
- Operating with 48°C of outdoor air temperature in cooling
- Operating with -15°C of outdoor air temperature in heating
- Copper/aluminum condensing coil
- Partial recovery of the condensing heat
- Plate exchangers / shell and tube



Compressor

High efficiency hermetic orbiting scroll compressor complete with oil charge, motor over-temperature and over-current devices and protection against excessive gas discharge temperature with oil heater, which starts automatically, keeps the oil from being diluted by the refrigerant when the compressor stops.

Compressors, fitted on rubber antivibration mounts to prevent transmission of noise and vibration, are connected in TANDEM or TRIO on a single refrigerating circuit with biphasic oil equalisation, it allows to reach high efficiency at partial load.

Uniform compression process with reduced number of moving parts which ensure very low levels of noise and vibration.

Structure

Structure and base made entirely of sturdy sheet steel, thickness of 30/10 or 40/10, with the surface treatment in Zinc–Magnesium painted, for the parts in view, with polyester powder RAL 9001 that guarantees excellent mechanical characteristics and high corrosion strength over time.

Internal exchanger (evaporator)

Direct expansion heat exchanger, braze-welded AISI 316 stainless steel plates, in pack without seals using copper as the brazing material, with low refrigerant charge and large exchange surface, complete with:

- external thermal insulation no-condensation, thickness 9,5 mm, in extruded elastomer foam with closed cells;
- differential pressure switch, water side;
- antifreeze heater to protect the water side exchanger, preventing the formation of frost if the water temperature falls below a set value.

Maximum operating pressure exchanger: 10 bar on the water side.

External exchanger (condenser)

Full aluminium microchannel coil with V structure open angle geometry. The entire exchanger (tubes, fins and manifolds) is made of aluminum and welded into a single body through a special brazing technology in a controlled-temperature chamber. The fins have a special corrugated surface to ensure maximum heat exchange efficiency. The special flat configuration of the pipes reduces the section that opposes to the air flow, limiting the pressure drops and maximizing the surface. The total refrigerant charge into the microchannel coil is reduced by 30% compared to an equivalent copper coil.

Fan

Axial fans with high performance and low-noise, balanced statically and dynamically, with blades in aluminum sheet coated in PP and sickle profile terminating with "Winglets", Wall ring in sheet steel pre-galvanised, directly coupled to the three-phase electric motor with external rotor and IP54 protection and class F insulation. Fans are located in aerodynamically shaped structures, equipped with accident prevention steel guards. Supplied with variable speed control (ECOBREEZE).

Refrigeration circuit

One or two independent refrigeration circuits made of copper, brazed and factory-assembled, complete with:

- anti-acid dehydrator filter with solid cartridge complete with quick-fit connector for refrigerant;
- high-pressure safety pressure switch;
- low pressure transducer;
- refrigerant temperature probe;
- electronic expansion valve;
- high pressure safety valve (safety valve with sealed tap open for inspection);
- double low pressure safety valves (safety valve with sealed tap open for inspection);
- liquid flow and humidity indicator;
- cut-off valve on compressor supply circuit;
- cut-off valve on liquid line.

Suction pipes thermally insulated with highly flexible EPDM rubber closed-cell elastomer insulation. Each cooling circuit is tested under pressure for leaks and is supplied complete with load of refrigerant gas.

Electrical panel

Entirely manufactured and wired in conformity to the EN 60204 standard.

The power section includes:

- door locking main circuit breaker;
- insulation transformer for powering the auxiliary circuit;
- magneto-thermal cut-out switches to protect compressors;
- magneto-thermal cut-out switches to protect fans;
- electrical panel ventilation.

The control section includes:

- proportional-integral-derivative adjustment of water temperature;
- anti-freeze protection;
- management of unit start-up from local or remote device (serial);
- compressor overload protection and timer;
- potential-free contacts for compressor status;
- self-diagnosis system with instant error code visualisation;
- pre-alarm function for water anti-frost and refrigerant gas high pressure functions;
- visualisation of no. of hours of compressor operation;
- interface terminal with graphic display;
- multifunction phase monitor;
- remote ON/OFF control;
- second set-point enabling by potential-free contact;
- automatic rotation control of compressor start-up to balance wear (breakaway + hours of operation);
- relay for remote cumulative fault signal;
- set values, error codes and parameters can be displayed;
- set-point compensation with outdoor air temperature probe
- electrical socket (max 400W)

Standard unit technical specifications

Accessories

- Finned coil protection grilles and compressor compartment (available only with options: PPBM)
- Energy meter
- Demand limit with signal 4-20mA;
- Demand limit with signal 0-10V
- Set point compensation with 4-20 mA signal
- Set-point compensation with 0-10 V signal
- Serial communication module for Modbus supervisor
- Serial communication module for LonWorks supervisor
- Serial communication module for BACnet-IP supervisor
- Inverter driven variable flow-rate user side control depending on the temperature differential
- Refrigerant leak detector assembled on the casing (available only with SC and EN configuration)
- Remote control via microprocessor control (separately supplied accessories)
- Electrical panel antifreeze protection for min. outdoor temperature down to -25°C
- Spring antivibration mounts (separately supplied accessories)
- Anti-seismic spring antivibration mounts (separately supplied accessories)
- Couple of manually operated shut-off valves (separately supplied accessories)
- Steel mesh strainer on the water side (separately supplied accessories)
- Mains power supply (separately supplied accessories)
- High and low pressure gauges
- Microchannel coils protection panels
- Ecoshare function for the automatic management of a group of units
- Power factor correction capacitors
- Disposal for inrush current reduction
- Storage tank
- Cutoff valve on compressor supply and return

Test

Unit subjected to factory-tested in specific steps and test pressure of the piping of the refrigerant circuit (with nitrogen and hydrogen), before shipping them.

Unit equipment with outdoor air low temperatures

MINIMUM OUTDOOR AIR TEMPERATURE		OPERATING UNIT	UNIT IN STAND-BY ⁽⁵⁾ (fed unit)	UNIT IN STORAGE (unit not fed)
+11°C	1	✓ STANDARD UNIT	✓ STANDARD UNIT	✓ STANDARD UNIT ⁽⁶⁾
+2°C	2			
-5°C	3			
Between -10°C and -15°C		✓ STANDARD UNIT ✓ GLYCOL IN AN APPROPRIATE PERCENTAGE or WATER SIDE DIFFERENTIAL PRESSURE SWITCH WITH ANTI-FREEZE PROTECTION (PSWSA)	✓ STANDARD UNIT ✓ GLYCOL IN AN APPROPRIATE PERCENTAGE or WATER SIDE DIFFERENTIAL PRESSURE SWITCH WITH ANTI-FREEZE PROTECTION (PSWSA)	
Between -15°C and -18°C		✓ STANDARD UNIT ✓ GLYCOL IN AN APPROPRIATE PERCENTAGE ✓ ELECTRICAL PANEL ANTIFREEZE PROTECTION (RE-25)	✓ WATER EMPTY UNIT or GLYCOL IN AN APPROPRIATE PERCENTAGE ✓ ELECTRICAL PANEL ANTIFREEZE PROTECTION (RE-25) ✗ NOT SUITABLE: BUILT-IN PUMPS, TOTAL AND PARTIAL RECOVERY, STORAGE TANK, SHELL AND TUBE EXCHANGER	NOT POSSIBLE
Between -18°C and -25°C		NOT POSSIBLE		
Between -25°C and -39°C		NOT POSSIBLE	✓ WATER EMPTY UNIT or GLYCOL IN AN APPROPRIATE PERCENTAGE ✓ ELECTRICAL PANEL ANTIFREEZE PROTECTION (RE-39) ✓ ACOUSTIC CONFIGURATION SC or EN ✓ WATER SIDE DIFFERENTIAL PRESSURE SWITCH WITH ANTI-FREEZE PROTECTION (PSWSA) ✗ NOT SUITABLE: BUILT-IN PUMPS, TOTAL AND PARTIAL RECOVERY, STORAGE TANK, SHELL AND TUBE EXCHANGER	NOT POSSIBLE

Data referred to the following conditions:
 - internal exchanger water = 12/7°C

1. Part load unit and air speed equal to 1 m/s.
2. Part load unit and air speed equal to 0.5 m/s.
3. Part load unit and outdoor air temperature at rest.
4. Unit at full load and outdoor air temperature at rest.

⁽⁵⁾ The water pumping unit must be fed and connected to the unit according to the manual.

⁽⁶⁾ Unit without water or containing water with an appropriate quantity of glycol.

At the unit start-up the water temperature or water with glycol must be inside the operating range indicated in the "Operating range" graph. To know the water freezing temperature on varying the glycol percentage refer to the specific 'Correction factors for glycol use' table.

⚠ Air conditions which are at rest are defined as the absence of air flowing towards the unit. Weak winds can induce air to flow through the exchanger and air-levels which can cause a reduction in the operating range. In the presence of predominant winds it is necessary to use suitable windbreak barriers.

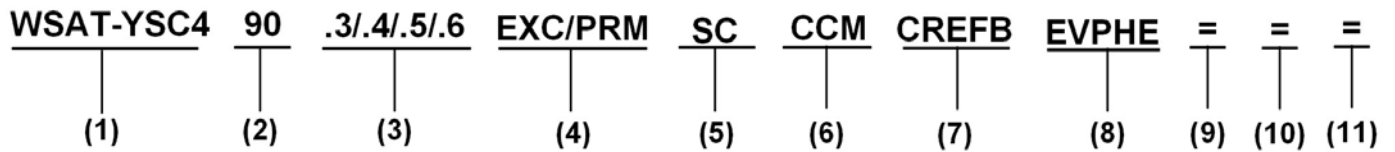

(1) Range

WSAT = Air cooled liquid chiller
YSC4 = SPINchiller range with multiscroll compressors and R-32 refrigerant

(2) Size

90 = Nominal compressor capacity (HP)

(3) Compressori

.3 / .4 / .5 / .6 = Compressor quantity

(4) Energy efficiency

EXC = EXCELLENCE Version (standard)
PRM = PREMIUM Version

(5) Acoustic configuration

ST = Standard acoustic configuration
SC = Acoustic configuration with compressor soundproofing (standard)
EN = Super-silenced acoustic configuration

(6) Condensing coil

CCM = Aluminum microchannel condensing coils (Standard)
CCME = E-coated microchannel coil

(7) Fans

CREFB = Device for fan consumption reduction of the external section ECOBREEZE type (Standard)

(8) Evaporator

EVPHE = Plate exchangers (Standard)
EVFTP = Shell and tube evaporator PED test

(9) Condensation heat recovery

(-) not required (standard)
D = Partial energy recovery
R = Total energy recovery

(10) Low evaporator water temperature configuration

(-) Not required (standard)
B - Low water temperature, down to -8°C (Brine)

(11) Pumping unit

(-) Not required (standard)
1PM = Hydropack with N° 1 pump
1PMH = Hydropack with N° 1 high static pressure pump
1PMV = Hydropack with N° 1 inverter pump
1PMVH = Hydropack with N° 1 high static pressure inverter pump
2PM = Hydropack with N° 2 pumps
2PMH = Hydropack with N° 2 high static pressure pumps
2PMV = Hydropack with N° 2 inverter pumps
2PMVH = Hydropack with N° 2 high static pressure inverter pumps

IVFDT

Inverter driven variable flow-rate user side control depending on the temperature differential

This option allows water flow-rate modulation to the unit during partial load conditions, maintaining stable the temperature difference between inlet and outlet to the heat exchanger. Flow-rate modulation is managed by embedded logic thanks to built-in temperature probes.

Designed for systems with primary circuit variable flow-rate systems decoupled from secondary circuit. With no building load the unit switches off the compressors while concerning pumps is possible to select:

- Active pumps with minimum flow-rate, monitoring secondary circuit temperature variations
- Pump switching off, periodically activating them (settable time) leading secondary circuit temperatures on primary circuit
- Pump switching off and waiting for the user signal for activation (free potential)

⚠ Device suitable for hydronic assemblies installed on board.

IVFEDT

External inverter driven variable flow-rate control depending on the temperature differential

This option allows water flow-rate modulation to the of pumping groups installed by the customer (external to the unit) during partial load conditions, maintaining stable the temperature difference between inlet and outlet to the heat exchanger. Flow-rate modulation is managed by embedded logic thanks to built-in temperature probes.

⚠ Device for hydronic assemblies not installed on board.

ACC

Storage tank

Steel storage tank complete with double layer covering with closed-cell insulation, stainless steel anti-freeze immersion resistance, bleed valve, draw off cock, cast-iron shut-off butterfly valve with quick connections and activation lever with a mechanical calibration lock at the evaporator output, quick connections with insulated casing.

Sizes 80.3 and 100.4 excellence and 90.3, 110.4 and 130.4 premium: the storage tank capacity is 420 liters.

Sizes 115.4, 130.4 excellence and 145.4, 170.5 and 185.5 premium: the storage tank capacity is 500 liters.

Sizes 155.5, 170.5 and 185.5 excellence and 210.6, 225.6 and 240.6 premium: the storage tank capacity is 780 liters.

Sizes 210.6, 225.6 and 240.6 excellence: the storage tank capacity is 1050 liters.

⚠ The device is installed and wired built-in the unit and is placed on the return from the system.

CONTA2

Energy meter

Allows to display and record the unit's main electrical parameters. The data can be displayed with the user interface on the unit or via the supervisor through the specific protocol variables.

It is possible to control: voltage (V), absorbed current (A), frequency (Hz), cosfi, power input (kW), absorbed energy (kWh), harmonic components (%)

The device is installed and wired built-in the unit.

CMSC9

Serial communication module for Modbus supervisor

This enables the serial connection of the supervision system, using Modbus as the communication protocol. It enables access to the complete list of operational variables, commands and alarms. Using this accessory every unit can dialogue with the main supervision systems.

The device is installed and wired built-in the unit.

⚠ The total length of each serial line do not exceed 1000 meters and the line must be connected in bus typology (in/out)

CMSC10

Serial communication module for LonWorks supervisor

This enables the serial connection of the supervision system which uses the LonWorks communication protocol. It enables access to a list of operating variables, commands and alarms which comply with the Echelon® standard.

The device is installed and wired built-in the unit.

⚠ The configuration and management activities for the LonWorks networks are the responsibility of the client.

⚠ LonWorks technology uses the LonTalk® protocol for communicating between the network nodes. Contact the service supplier for further information.

⚠ The total length of each serial line do not exceed 1000 meters and the line must be connected in bus typology (in/out)

CMSC11

Serial communication module for BACnet/IP supervisor

This enables the serial connection of the supervision system, using BACnet/IP as the communication protocol. It enables access to the complete list of operational variables, commands and alarms. Using this accessory every unit can dialogue with the main supervision systems.

The device is installed and wired built-in the unit.

⚠ The configuration and management activities for the BACnet networks are the responsibility of the client.

⚠ The total length of each serial line do not exceed 1000 meters and the line must be connected in bus typology (in/out)

Built-in options

SCP4	Set-point compensation with 0-10 V signal <p>This device enables the set-point to be varied which is pre-set using an external 0÷10 V signal. The device is installed and wired built-in the unit.</p>
SPC1	Set-point compensation with 4-20 mA signal <p>This device enables the set-point to be varied which is pre-set using an external 4-20 mA signal. The device is installed and wired built-in the unit.</p>
ECS	ECOSHARE function for the automatic management of a group of units <p>The device allows automatic management of units that operate on the same hydraulic circuit, by creating a local communication network. There are two control modes that can be set via a parameter during the activation stage. They both distribute the heat load on the available units by following the distribution logic to benefit from efficiency levels at part load.</p> <p>Moreover: Mode 1 - it keeps all the pumps active Mode 2 - it activates only the pumps of the unit required to operate</p> <p>The device allows for rotation based on the criterion of minimum wear and management of units in stand-by. There are various unit sizes. Every unit must be fitted with the ECOSHARE feature. The set of units is controlled by a Master unit. The local network can be extended up to 7 units (1 Master and 6 Slave).</p> <ul style="list-style-type: none">⚠ The unit supplied with this device can also be equipped at the same time with the RCMRX option and one of the CMSC9 / CMSC10 / CMSC11 options.⚠ It is necessary to provide a non-return valve for each unit installed in hydraulic parallel and equipped with an hydronic assembly installed on board (Installation by the Customer)..
PFCP	Power-factor correction capacitors (cosfi > 0.9) <p>The component is necessary to lower the phase difference between current and voltage in the electromagnetic components of the unit (e.g. asynchronous motors). The component allows to put the cosfi power factor to values on average higher than 0.9, reducing the network reactive power. This often leads to an economic benefit which the energy provider grants to the final user.</p> <p>The device is installed and wired built-in the unit.</p>
SFSTR	Disposal for inrush current reduction <p>Electronic device which automatically starts up the compressors gradually, reducing the starting current for the unit by around 40% in comparison with the nominal value. This results in the reduction of the starting torque of the ON/OFF compressor, it is more protected from mechanical stresses leading to an increased life of the component. The noise is also reduced.</p> <p>Device installed and wired built-in the unit.</p>
RE-25	Electrical panel antifreeze protection for min. outdoor temperature down to -25°C <p>This option is necessary for very cold climates, where the external temperature can go down to -25°C. It includes self-regulating temperature maintaining resistances which are able to protect the electrical panel against condensation and frost guaranteeing that it functions correctly. The choice of device should be carried out on the basis of the minimum temperatures reached at the unit installation site.</p> <p>The device is built-in the unit.</p> <ul style="list-style-type: none">⚠ It is necessary to make precautions against build up of snow and ice in front of the exhaust and outdoor air inlet locations⚠ This accessory operates even when the unit is switched off provided that the power supply is maintained active and the unit continues to be connected.⚠ This accessory does not lead to substantial variations in the electrical data for the unit which has been declared in the Electrical Data section.
RE-39	Electrical panel antifreeze protection for min. outdoor temperature down to -39°C <p>This option is necessary for very cold climates, where the external temperature can go down to -39°C. It includes self-regulating temperature maintaining resistances which are able to protect the electrical panel against condensation and frost guaranteeing that it functions correctly, and self-regulating resistances for the protection of the high-pressure safety switches.</p> <p>The choice of device should be carried out on the basis of the minimum temperatures reached at the unit installation site. The device is built-in the unit.</p> <ul style="list-style-type: none">⚠ It is necessary to make precautions against build up of snow and ice in front of the exhaust and outdoor air inlet locations⚠ This accessory operates even when the unit is switched off provided that the power supply is maintained active and the unit continues to be connected.⚠ This accessory does not lead to substantial variations in the electrical data for the unit which has been declared in the Electrical Data section.
MHP	High and low pressure gauges <p>It includes two liquid pressure gauges for the analog measurement of refrigerant pressures on suction and discharge lines of the compressors with pressure sockets installed in the unit in an easily accessible location.</p> <p>The accessory is built-in the unit.</p>

PSWSA	<p>Water side differential pressure switch with antifreeze protection</p> <p>It allows unit operation with -15°C of outdoor air temperature without using glycol. It includes a heating cable able to protect the water side differential pressure switch. Device installed and wired built-in the unit.</p>	
SDV	<p>Cutoff valve on compressor supply and return</p> <p>An option which integrates the supply cutoff valve, which is supplied as standard. The presence of the cock at the intake as well enables the compressors to be isolated and substituted without discharging the refrigerant from within the refrigeration circuit. This means that the extraordinary maintenance activities are facilitated. Device installed built-in the unit.</p>	
CCME	<p>E-coated microchannel coil</p> <p>The full aluminium microchannel coil is completely treated by electrolysis so as to create a protective layer of epoxy polymer on the surface, with the following characteristics:</p> <ul style="list-style-type: none"> • over 3000 hours of protection against salt spray (ASTM G85 A3 - SWAAT); • over 2000 hours of protection against UV rays (ASTM G155-05a) • provide a very high resistance against corrosion. 	
RPRI	<p>Refrigerant leak detector assembled on the casing</p> <p>Leak detector device built-in installed and placed inside the compressor box, it detects leaks of the internal refrigeration circuit.</p> <p>⚠ Option available only for acoustic configuration with compressor soundproofing (SC) and super-silenced (EN).</p>	
PPBM	<p>Microchannel coils protection panels</p> <p>Microchannel coils protection panels supplied on the manifold side. They guarantee greater protection during transport and from accidental contact with things or people.</p>	
PGCC	<p>Finned coil protection grilles and compressor compartment</p> <p>This accessory is used to protect the external coil from the accidental contact with external things or people. Ideal for installation in places where persons can pass from, such as car parks, terraces, etc. The accessory is provided and installed built-in the unit. Grille slot 25mm.</p> <p>⚠ This option is not suitable for application in sulphuric environments. ⚠ Option available only in combination with microchannel coils protection panels (PPBM)</p>	
EVFTP	<p>Shell and tube evaporator PED test</p> <p>Direct expansion exchanger with refrigerant side independent circuit for each compressor. The exchanger is composed of a cover made of carbon steel. The tubes, anchored to the tube plate by mechanical expansion, are made of copper, high efficiency, internally rifled to improve thermal exchange and specially designed for use with modern ecological refrigerants. It also includes a water side protection differential switch, an anti-freeze heating element to protect against icing, and covering in closed-cell thermo-insulating material that prevents the formation of condensation and heat exchange with the exterior. The water connections of the exchanger are quick-release with splined joint (Victaulic).</p>	
DLM0-10	<p>Demand limit with signal 0-10V</p> <p>The device allows to limit the absorption unit through an external signal type 0-10V.</p>	
DLM4-20	<p>Demand limit with signal 4-20mA</p> <p>The device allows to limit the absorption unit through an external signal type 4-20mA.</p>	
PFGP	<p>Soundproofing paneling of the pumping unit</p> <p>Configuration used to increase the hydronic assembly's silent operation. It is made up of steel casings lined internally with high-density material with a soundproofing function. The casings are pre-painted with RAL 9001 color.</p> <p>Option available for all pumping groups installed on the unit, in combination with the standard acoustic configuration (ST) and with compressor soundproofing (SC)</p>	

Accessories separately supplied

RCMRX

Remote control via microprocessor control

This option allows to have full control over all the unit functions from a remote position. It can be easily installed on the wall and has the same aspect and functions of the user interface on the unit.

- ⚠ All device functions can be repeated with a normal portable PC connected to the unit with an Ethernet cable and equipped with an internet navigation browser.
- ⚠ The device must be installed on the wall with suitable plugs and connected to the unit (installation and wiring to be conducted by the Customer). Maximum remote control distance 350 m without auxiliary power supply.
- ⚠ For distances greater than 350 m and in any case less than 700 m it is necessary to install the 'PSX - Mains power unit' accessory.
- ⚠ Data and power supply serial connection cable n.1 twisted and shielded pair. Diameter of the individual conductor 0.8 mm.
- ⚠ Installation is a responsibility of the Customer..

AMMX

Spring antivibration mounts

The spring antivibration mounts are attached in special housing on the support frame and serve to smooth the vibrations produced by the unit thus reducing the noise transmitted to the support structure.

- ⚠ Installation is a responsibility of the Customer.

AMMSX

Anti-seismic spring antivibration mounts

The anti-seismic spring antivibration mounts must be fastened in special housings on the supporting metal struts. The containment structure is designed to ensure high resistance multidirectional forces acting on the surface of the unit in the presence of wind and / or telluric movements. The antivibration mounts have been tested according to ANSI/ASHRAE 171-2008 standard (Method of Testing Seismic Restraint devices for HVAC&R Equipment). The performance levels and the test methodology have been validated and certified by Lloyd's Register.

- ⚠ Installation is a responsibility of the Customer.

IFWX

Steel mesh strainer on the water side

The device stops the exchanger from being clogged by any impurities which are in the hydraulic circuit. The mechanical steel mesh strainer must be placed on the water input line. It can be easily dismantled for periodical maintenance and cleaning. It also includes:

- cast-iron shut-off butterfly valve with quick connections and activation lever with a mechanical calibration lock;
- quick connections with insulated casing.

- ⚠ Pressure drop referred to a clean filter.
- ⚠ Installation is the responsibility of the Client, externally to the unit.
- ⚠ Check for the presence of the required hydraulic shut-off valves in the system, in order to undertake periodical maintenance.

CSVX

Couple of manually operated shut-off valves

The kit allows to isolated the input and output water circuit. It includes:

- no. 2 of cast-iron shut-off butterfly valves with fast fittings and activation lever with a mechanical setting lock
- no. 2 of victaulic connections

- ⚠ Installazione a cura del Cliente, esternamente all'unità.

PSX

Mains power supply

The device allows the unit and the remote control to communicate with the user interface even when the serial line is longer than 350m.

It must be connected to the serial line at a distance of 350m from the unit and allows to extend the length to 700m maximum in total. The device requires an external power supply at 230V AC.

- ⚠ Power supply at 230V AC provided by Customer.
- ⚠ Installation is a responsibility of the Customer.

Performance - Excellence

Standard acoustic configuration (ST) / Compressor soundproofing (SC)

SIZE			80.3	100.4	115.4	130.4	155.5	170.5	185.5	210.6	225.6	240.6
Cooling capacity	1	[kW]	223	267	315	364	424	472	520	574	624	676
Compressor power input	1	[kW]	64,3	80,3	93,2	107	125	139	156	171	186	204
Total power input	2	[kW]	68,9	84,8	98,9	114	133	148	165	182	198	215
Partial recovery heating capacity	3	[kW]	74,6	90,3	106	123	143	159	176	194	211	229
Total recovery heating capacity	3	[kW]	280	338	398	460	536	597	659	726	791	857
EER	1	-	3,23	3,15	3,18	3,20	3,18	3,19	3,15	3,16	3,16	3,14
Water flow-rate (User Side)	1	[l/s]	10,6	12,8	15,0	17,4	20,2	22,6	24,8	27,4	29,8	32,3
Internal exchanger pressure drops	1	[kPa]	20	27	30	37	41	38	39	46	50	41
Cooling capacity (EN14511:2018)	4	[kW]	222	267	314	364	423	472	520	573	624	675
Total power input (EN14511:2018)	4	[kW]	69,4	85,5	100	115	135	149	167	184	200	218
EER (EN14511:2018)	4	-	3,20	3,12	3,15	3,17	3,15	3,16	3,11	3,12	3,12	3,10
SEER	6	-	4,70	4,67	4,78	4,75	4,92	5,00	4,96	4,94	4,96	4,90
SEPR	7	-	6,44	6,40	6,55	6,51	6,54	6,65	6,60	6,57	6,60	6,52
Cooling capacity (AHRI 550/590)	5	[kW]	221	265	312	361	420	468	514	568	622	671
Total power input (AHRI 550/590)	5	[kW]	68,7	84,5	98,5	113	133	147	165	181	197	215
COP _R	5	-	3,22	3,14	3,17	3,19	3,16	3,18	3,12	3,14	3,16	3,12
IPLV	5	-	5,05	4,93	4,85	4,82	4,85	4,93	4,88	4,87	4,84	4,82

The Product is compliant with the Erp (Energy Related Products) European Directive. It includes the Commission delegated Regulation (EU) No 2016/2281, also known as Ecodesign LOT21. Contains fluorinated greenhouse gases (GWP 675)

1. Data referred to the following conditions: internal exchanger water temperature = 12/7 °C. Entering external exchanger air temperature = 35°C. Evaporator fouling factor = 0.44 x 10⁻⁴ m² K/W.
2. The Total Power Input value does not take into account the part related to the pumps and required to overcome the pressure drops for the circulation of the solution inside the exchangers.
3. Recovery exchanger water = 40/45°C
4. Data compliant to Standard EN 14511:2018 referred to the following conditions: internal exchanger water temperature = 12/7 °C. Entering external exchanger air temperature = 35°C
5. Data compliant to Standard AHRI 550/590 referred to the following conditions: internal exchanger water temperature = 6,7 °C. Water flow-rate 0,043 l/s per kW. Entering external exchanger air temperature = 35°C. Evaporator fouling factor = 0.18 x 10⁻⁴ m² K/W
6. Data compliant to Standard EN 14825:2018
7. Data compliant according to EU regulation 2016/2281

Super-silenced acoustic configuration (EN)

SIZE			80.3	100.4	115.4	130.4	155.5	170.5	185.5	210.6	225.6	240.6
Cooling capacity	1	[kW]	217	262	306	355	409	459	504	556	599	646
Compressor power input	1	[kW]	67,5	85,7	98,4	113	130	147	165	183	197	217
Total power input	2	[kW]	70,1	88,2	102	116	134	152	171	189	203	224
Partial recovery heating capacity	3	[kW]	74,0	90,4	105	122	140	158	174	192	207	224
Total recovery heating capacity	3	[kW]	276	336	392	453	522	588	649	717	772	836
EER	1	-	3,10	2,97	3,01	3,04	3,04	3,02	2,96	2,95	2,95	2,89
Water flow-rate (User Side)	1	[l/s]	10,4	12,5	14,6	16,9	19,5	21,9	24,1	26,6	28,6	30,8
Internal exchanger pressure drops	1	[kPa]	19	26	29	34	39	37	37	44	47	38
Cooling capacity (EN14511:2018)	4	[kW]	217	261	306	354	408	459	504	556	599	645
Total power input (EN14511:2018)	4	[kW]	70,5	88,9	102	118	136	153	172	191	205	225
EER (EN14511:2018)	4	-	3,07	2,94	2,98	3,01	3,01	2,99	2,93	2,91	2,92	2,86
SEER	6	-	4,66	4,62	4,73	4,70	4,87	4,94	4,91	4,89	4,91	4,79
SEPR	7	-	6,38	6,33	6,48	6,44	6,48	6,57	6,53	6,50	6,53	6,46
Cooling capacity (AHRI 550/590)	5	[kW]	215	259	303	351	405	455	499	551	597	643
Total power input (AHRI 550/590)	5	[kW]	69,8	87,8	101	116	134	151	170	188	203	223
COP _R	5	-	3,08	2,95	3,00	3,03	3,02	3,01	2,94	2,93	2,94	2,88
IPLV	5	-	5,01	4,86	4,79	4,75	4,80	4,78	4,87	4,85	4,83	4,80

The Product is compliant with the Erp (Energy Related Products) European Directive. It includes the Commission delegated Regulation (EU) No 2016/2281, also known as Ecodesign LOT21. Contains fluorinated greenhouse gases (GWP 675)

1. Data referred to the following conditions: internal exchanger water temperature = 12/7 °C. Entering external exchanger air temperature = 35°C. Evaporator fouling factor = 0.44 x 10⁻⁴ m² K/W.
2. The Total Power Input value does not take into account the part related to the pumps and required to overcome the pressure drops for the circulation of the solution inside the exchangers.
3. Recovery exchanger water = 40/45°C
4. Data compliant to Standard EN 14511:2018 referred to the following conditions: internal exchanger water temperature = 12/7 °C. Entering external exchanger air temperature = 35°C
5. Data compliant to Standard AHRI 550/590 referred to the following conditions: internal exchanger water temperature = 6,7 °C. Water flow-rate 0,043 l/s per kW. Entering external exchanger air temperature = 35°C. Evaporator fouling factor = 0.18 x 10⁻⁴ m² K/W
6. Data compliant to Standard EN 14825:2018
7. Data compliant according to EU regulation 2016/2281

General technical data

Performance - Premium

Standard acoustic configuration (ST) / Compressor soundproofing (SC)

SIZE			90.3	110.4	130.4	145.4	170.5	185.5	210.6	225.6	240.6
Cooling capacity	1	[kW]	232	291	333	385	444	484	538	591	644
Compressor power input	1	[kW]	80,5	96,6	118	131	148	171	189	198	222
Total power input	2	[kW]	83,9	101	123	137	155	177	197	207	231
Partial recovery heating capacity	3	[kW]	81,1	101	117	134	154	170	189	205	225
Total recovery heating capacity	3	[kW]	303	377	438	502	576	636	707	768	842
EER	1	-	2,76	2,88	2,72	2,80	2,87	2,73	2,73	2,85	2,79
Water flow-rate (User Side)	1	[l/s]	11,1	13,9	15,9	18,4	21,2	23,1	25,7	28,2	30,8
Internal exchanger pressure drops	1	[kPa]	21	32	34	42	44	40	48	49	51
Cooling capacity (EN14511:2018)	4	[kW]	232	291	333	384	443	483	537	590	644
Total power input (EN14511:2018)	4	[kW]	84,5	102	124	139	156	179	199	209	233
EER (EN14511:2018)	4	-	2,74	2,85	2,70	2,77	2,84	2,70	2,70	2,82	2,76
SEER	6	-	4,38	4,48	4,46	4,47	4,65	4,64	4,61	4,69	4,62
SEPR	7	-	6,00	6,13	6,11	6,13	6,18	6,17	6,13	6,23	6,15
Cooling capacity (AHRI 550/590)	5	[kW]	230	288	330	381	440	479	532	585	637
Total power input (AHRI 550/590)	5	[kW]	83,6	101	122	137	154	177	196	206	230
COP _r	5	-	2,75	2,85	2,70	2,78	2,86	2,71	2,71	2,84	2,77
IPLV	5	-	4,59	4,79	4,64	4,67	4,65	4,73	4,59	4,57	4,55

The Product is compliant with the Erp (Energy Related Products) European Directive. It includes the Commission delegated Regulation (EU) No 2016/2281, also known as Ecodesign LOT21. Contains fluorinated greenhouse gases (GWP 675)

1. Data referred to the following conditions: internal exchanger water temperature = 12/7 °C. Entering external exchanger air temperature = 35°C. Evaporator fouling factor = 0.44 x 10⁻⁴ m² K/W.
2. The Total Power Input value does not take into account the part related to the pumps and required to overcome the pressure drops for the circulation of the solution inside the exchangers.
3. Recovery exchanger water = 40/45°C
4. Data compliant to Standard EN 14511:2018 referred to the following conditions: internal exchanger water temperature = 12/7 °C. Entering external exchanger air temperature = 35°C
5. Data compliant to Standard AHRI 550/590 referred to the following conditions: internal exchanger water temperature = 6,7 °C. Water flow-rate 0,043 l/s per kW. Entering external exchanger air temperature = 35°C. Evaporator fouling factor = 0.18 x 10⁻⁴ m² K/W
6. Data compliant to Standard EN 14825:2018
7. Data compliant according to EU regulation 2016/2281

Super-silenced acoustic configuration (EN)

SIZE			90.3	110.4	130.4	145.4	170.5	185.5	210.6	225.6	240.6
Cooling capacity	1	[kW]	228	283	329	374	432	474	527	580	623
Compressor power input	1	[kW]	83,3	99,6	124	135	153	178	196	205	230
Total power input	2	[kW]	85,8	103	127	139	158	183	202	211	236
Partial recovery heating capacity	3	[kW]	80,8	99,5	118	132	152	170	188	204	222
Total recovery heating capacity	3	[kW]	301	371	439	493	567	631	701	761	827
EER	1	-	2,65	2,75	2,59	2,69	2,74	2,59	2,62	2,75	2,64
Water flow-rate (User Side)	1	[l/s]	10,9	13,5	15,7	17,8	20,6	22,6	25,2	27,7	29,7
Internal exchanger pressure drops	1	[kPa]	21	30	33	39	42	39	46	47	48
Cooling capacity (EN14511:2018)	4	[kW]	227	283	329	374	432	474	527	580	622
Total power input (EN14511:2018)	4	[kW]	86,3	104	128	140	159	184	203	213	239
EER (EN14511:2018)	4	-	2,63	2,73	2,57	2,67	2,71	2,57	2,59	2,72	2,61
SEER	6	-	4,34	4,44	4,42	4,45	4,62	4,61	4,59	4,63	4,59
SEPR	7	-	5,95	6,08	6,06	6,10	6,14	6,13	6,10	6,16	6,10
Cooling capacity (AHRI 550/590)	5	[kW]	226	281	326	370	429	470	522	574	616
Total power input (AHRI 550/590)	5	[kW]	85,4	103	126	138	157	182	201	210	235
COP _r	5	-	2,65	2,73	2,59	2,68	2,73	2,58	2,60	2,73	2,62
IPLV	5	-	4,54	4,74	4,62	4,67	4,62	4,50	4,57	4,56	4,51

The Product is compliant with the Erp (Energy Related Products) European Directive. It includes the Commission delegated Regulation (EU) No 2016/2281, also known as Ecodesign LOT21. Contains fluorinated greenhouse gases (GWP 675)

1. Data referred to the following conditions: internal exchanger water temperature = 12/7 °C. Entering external exchanger air temperature = 35°C. Evaporator fouling factor = 0.44 x 10⁻⁴ m² K/W.
2. The Total Power Input value does not take into account the part related to the pumps and required to overcome the pressure drops for the circulation of the solution inside the exchangers.
3. Recovery exchanger water = 40/45°C
4. Data compliant to Standard EN 14511:2018 referred to the following conditions: internal exchanger water temperature = 12/7 °C. Entering external exchanger air temperature = 35°C
5. Data compliant to Standard AHRI 550/590 referred to the following conditions: internal exchanger water temperature = 6,7 °C. Water flow-rate 0,043 l/s per kW. Entering external exchanger air temperature = 35°C. Evaporator fouling factor = 0.18 x 10⁻⁴ m² K/W
6. Data compliant to Standard EN 14825:2018
7. Data compliant according to EU regulation 2016/2281

Construction

Excellence

SIZE		80.3	100.4	115.4	130.4	155.5	170.5	185.5	210.6	225.6	240.6
Compressor											
Type of compressors	1	SCROLL									
Refrigerant		R-32									
No. of compressors	Nr	3	4	4	4	5	5	5	6	6	6
Rated power (C1)	HP	40	50	50	50	50	65	80	105	105	120
Rated power (C2)	HP	40	50	65	80	105	105	105	105	120	120
Std Capacity control steps		4	4	6	4	6	7	6	8	8	6
Oil charge (C1)	l	8	9	9	9	9	11	13	17	17	23
Oil charge(C2)	l	6	9	11	13	17	17	17	17	23	23
Refrigerant charge (C1)	kg	14	13	14	15	16	26	27	29	31	30
Refrigerant charge (C2)	kg	14	12	18	22	29	26	29	32	36	35
Refrigeration circuits	Nr	2	2	2	2	2	2	2	2	2	2
Internal exchanger (evaporator)											
Type of internal exchanger	2	PHE									
N. of internal exchanger	Nr	1	1	1	1	1	1	1	1	1	1
Water content	l	20	20	24	28	36	48	57	57	49	60
Minimum system water content	l	1350	2700	2700	2200	3200	2850	3150	3450	3750	4500
External exchanger (condenser)											
Type of external exchanger	3	CCM									
Number of coils	Nr	4	4	5	6	7	8	8	9	10	10
External Section Fans											
Type of fans	4	AX									
Number of fans	Nr	4	4	5	6	7	8	8	9	10	10
Type of motor	5	EC									
Standard airflow (ST/SC)	l/s	21778	21778	27222	32667	38111	43556	43556	49000	54444	54444
Standard airflow (EN)	l/s	16111	16111	20139	24167	28194	32222	32222	36250	40278	40278
Connections											
Water fittings		4"	4"	4"	4"	5"	5"	5"	5"	5"	5"
Power supply											
Standard power supply		400/3"/50									
Electrical data											
F.L.A. - Total	A	158,2	191,0	220,8	250,6	298,3	328,1	356,0	403,7	433,5	461,4
F.L.I. - Total	kW	96,3	115,4	135,1	154,7	183,6	203,2	221,6	250,5	270,1	288,5
M.I.C. - Value	6 A	492,5	432,7	555,1	584,9	632,6	662,4	690,3	738,0	767,8	795,7
M.I.C. - with soft start accessory	6 A	314,5	301,2	377,1	406,9	454,6	484,4	512,3	560,0	589,8	617,7

1. SCROLL = SCROLL compressor
2. PHE = Plate heat exchanger
3. CCM = Full aluminium microchannel coils
4. AX = Axial fan
5. EC = Asynchronous motor with permanent magnet commuted electronically.
6. M.I.C.=Maximum unit starting current. The M.I.C. value is obtained adding the max. compressor starting current of the highest size to the power input at max. admissible conditions (F.L.A.) of the remaining electric components.

Unbalance between phase max 2 %

Voltage variation: max +/- 10%

Electrical data refer to standard units; according to the installed accessories, the data can suffer some variations.

General technical data

Construction

Premium

SIZE		90.3	110.4	130.4	145.4	170.5	185.5	210.6	225.6	240.6
Compressor										
Type of compressors	1	SCROLL								
Refrigerant		R-32								
No. of compressors	Nr	3	4	4	4	5	5	6	6	6
Rated power (C1)	HP	25	50	65	65	50	65	105	105	120
Rated power (C2)	HP	65	60	65	80	120	120	105	120	120
Std Capacity control steps		4	6	6	6	5	7	8	8	6
Oil charge (C1)	l	4	9	11	11	9	11	17	17	23
Oil charge(C2)	l	11	11	11	13	23	23	17	23	23
Refrigerant charge (C1)	kg	10	12	14	17	15	17	31	28	33
Refrigerant charge (C2)	kg	15	13	14	18	25	26	31	28	29
Refrigeration circuits	Nr	2	2	2	2	2	2	2	2	2
Internal exchanger (evaporator)										
Type of internal exchanger	2	PHE								
N. of internal exchanger	Nr	1	1	1	1	1	1	1	1	1
Water content	l	20	20	24	28	36	48	48	57	60
Minimum system water content	l	2350	2050	2550	2350	2800	2950	3250	3550	5450
External exchanger (condenser)										
Type of external exchanger	3	CCM								
Number of coils	Nr	3	4	4	5	6	6	7	8	8
External Section Fans										
Type of fans	4	AX								
Number of fans	Nr	3	4	4	5	6	6	7	8	8
Type of motor	5	EC								
Standard airflow (ST/SC)	l/s	16333	21778	21778	27222	32667	32667	38111	43556	43556
Standard airflow (EN)	l/s	13750	18333	18333	22917	27500	27500	32083	36667	36667
Connections										
Water fittings		4"	4"	4	4"	5"	5"	5"	5"	5"
Power supply										
Standard power supply		400/3~/50								
Electrical data										
F.L.A. - Total	A	171,1	209,7	246,7	276,5	324,2	352,1	399,9	429,7	457,5
F.L.I. - Total	kW	105,0	128,2	152,2	171,9	200,7	219,1	248,0	267,6	286,0
M.I.C. - Value	6 A	505,4	544,0	581,0	610,8	658,6	686,4	734,2	764,0	791,8
M.I.C. - with soft start accessory	6 A	327,4	366,0	403,0	432,8	480,6	508,4	556,2	586,0	613,8

1. SCROLL = SCROLL compressor
2. PHE = Plate heat exchanger
3. CCM = Full aluminium microchannel coils
4. AX = Axial fan
5. EC = Asynchronous motor with permanent magnet commuted electronically.
6. M.I.C.=Maximum unit starting current. The M.I.C. value is obtained adding the max. compressor starting current of the highest size to the power input at max. admissible conditions (F.L.A.) of the remaining electric components.

Unbalance between phase max 2 %

Voltage variation: max +/- 10%

Electrical data refer to standard units; according to the installed accessories, the data can suffer some variations.

Sound levels - Excellence

Standard acoustic configuration (ST)

SIZE	Sound power level (dB) - Octave band (Hz)								Sound power level	Sound pressure level
	63	125	250	500	1000	2000	4000	8000	dB(A)	dB(A)
80.3	73	74	80	85	86	85	77	67	71	90
100.4	75	76	83	86	86	86	79	70	72	91
115.4	75	76	83	87	87	87	79	70	72	92
130.4	76	77	84	88	89	88	80	70	73	93
155.5	74	75	80	88	90	90	82	70	74	94
170.5	75	75	80	88	91	90	82	70	74	95
185.5	75	75	81	89	91	91	82	70	75	95
210.6	76	76	82	90	92	92	83	71	75	96
225.6	76	76	81	90	92	91	83	71	75	96
240.6	76	77	82	90	93	92	84	71	76	97

Sound levels refer to full load units, in test nominal conditions. The sound pressure level refers to 1 m. from the standard unit outer surface operating in open field. Measures according to UNI EN ISO 9614-2 regulations, with respect to the EUROVENT 8/1 certification, which provides for a tolerance of 3 dB(A).

Data referred to the following conditions:
 - internal exchanger water temperature = 12/7 °C
 - ambient temperature = 35 °C

Acoustic configuration with compressor soundproofing (SC)

SIZE	Sound power level (dB) - Octave band (Hz)								Sound power level	Sound pressure level
	63	125	250	500	1000	2000	4000	8000	dB(A)	dB(A)
80.3	71	72	77	83	83	82	74	64	68	87
100.4	72	74	79	84	84	83	76	67	69	88
115.4	73	74	79	85	85	84	76	67	69	89
130.4	74	75	80	85	86	85	77	67	70	90
155.5	72	73	77	85	87	85	78	66	70	90
170.5	73	73	77	86	88	85	79	67	71	91
185.5	73	73	78	86	88	86	79	67	71	91
210.6	73	74	79	87	89	86	79	68	71	92
225.6	74	74	79	87	89	87	80	67	71	92
240.6	74	75	79	88	90	88	80	68	72	93

Sound levels refer to full load units, in test nominal conditions. The sound pressure level refers to 1 m. from the standard unit outer surface operating in open field. Measures according to UNI EN ISO 9614-2 regulations, with respect to the EUROVENT 8/1 certification, which provides for a tolerance of 3 dB(A).

Data referred to the following conditions:
 - internal exchanger water temperature = 12/7 °C
 - ambient temperature = 35 °C

General technical data

Super-silenced acoustic configuration (EN)

SIZE	Sound power level (dB) - Octave band (Hz)								Sound power level	Sound pressure level
	63	125	250	500	1000	2000	4000	8000	dB(A)	dB(A)
80.3	58	71	75	79	79	80	71	64	65	84
100.4	59	72	77	80	78	80	72	66	65	84
115.4	60	73	78	81	81	82	73	66	66	86
130.4	59	72	77	81	81	82	73	65	66	86
155.5	59	71	76	80	82	81	73	65	66	86
170.5	60	71	77	81	83	82	74	66	67	87
185.5	60	72	77	82	84	83	75	66	68	88
210.6	61	72	78	82	84	83	75	66	67	88
225.6	61	72	77	82	84	84	75	66	67	88
240.6	61	72	78	83	85	84	76	66	68	89

Sound levels refer to full load units, in test nominal conditions. The sound pressure level refers to 1 m. from the standard unit outer surface operating in open field. Measures according to UNI EN ISO 9614-2 regulations, with respect to the EUROVENT 8/1 certification, which provides for a tolerance of 3 dB(A).

Data referred to the following conditions:
 - internal exchanger water temperature = 12/7 °C
 - ambient temperature = 35 °C

Sound levels - Premium

Standard acoustic configuration (ST)

SIZE	Sound power level (dB) - Octave band (Hz)								Sound power level	Sound pressure level
	63	125	250	500	1000	2000	4000	8000	dB(A)	dB(A)
90.3	73	74	81	84	86	85	78	68	71	90
110.4	74	76	83	86	87	86	79	69	72	91
130.4	74	75	83	86	87	87	79	69	73	92
145.5	75	76	83	87	89	88	80	70	73	93
170.5	73	74	80	87	90	90	81	70	74	94
185.5	73	74	80	87	90	90	81	69	74	94
210.6	74	75	81	88	91	91	82	71	75	95
225.6	75	76	82	89	92	92	83	71	76	96
240.6	75	75	81	89	92	91	83	71	76	96

Sound levels refer to full load units, in test nominal conditions. The sound pressure level refers to 1 m. from the standard unit outer surface operating in open field. Measures according to UNI EN ISO 9614-2 regulations, with respect to the EUROVENT 8/1 certification, which provides for a tolerance of 3 dB(A).

Data referred to the following conditions:
 - internal exchanger water temperature = 12/7 °C
 - ambient temperature = 35 °C

Acoustic configuration with compressor soundproofing (SC)

SIZE	Sound power level (dB) - Octave band (Hz)								Sound power level	Sound pressure level
	63	125	250	500	1000	2000	4000	8000	dB(A)	dB(A)
90.3	71	72	77	83	83	82	74	65	68	87
110.4	72	74	79	84	84	83	76	66	69	88
130.4	72	73	79	84	85	84	76	66	70	89
145.5	72	73	79	84	85	84	76	66	69	89
170.5	71	72	77	85	87	85	77	66	70	90
185.5	71	72	77	85	87	85	78	66	70	90
210.6	72	73	78	86	88	86	78	67	71	91
225.6	73	74	79	87	89	87	79	68	72	92
240.6	73	74	79	86	89	87	79	67	72	92

Sound levels refer to full load units, in test nominal conditions. The sound pressure level refers to 1 m. from the standard unit outer surface operating in open field. Measures according to UNI EN ISO 9614-2 regulations, with respect to the EUROVENT 8/1 certification, which provides for a tolerance of 3 dB(A).

Data referred to the following conditions:
 - internal exchanger water temperature = 12/7 °C
 - ambient temperature = 35 °C

General technical data

Super-silenced acoustic configuration (EN)

SIZE	Sound power level (dB) - Octave band (Hz)								Sound power level	Sound pressure level
	63	125	250	500	1000	2000	4000	8000	dB(A)	dB(A)
90.3	60	73	76	80	79	80	71	63	65	84
110.4	63	76	79	82	81	82	73	65	67	86
130.4	62	74	78	82	81	82	73	65	67	86
145.5	63	75	79	83	83	83	73	65	67	87
170.5	62	74	77	82	83	82	74	65	67	87
185.5	63	75	78	83	84	83	75	65	68	88
210.6	64	76	79	84	85	84	76	67	69	89
225.6	64	76	79	84	85	84	76	66	69	89
240.6	63	76	78	84	85	84	76	66	69	89

Sound levels refer to full load units, in test nominal conditions. The sound pressure level refers to 1 m. from the standard unit outer surface operating in open field. Measures according to UNI EN ISO 9614-2 regulations, with respect to the EUROVENT 8/1 certification, which provides for a tolerance of 3 dB(A).

Data referred to the following conditions:
- internal exchanger water temperature = 12/7 °C
- ambient temperature = 35 °C

Correction factors for ethylene glycol use

% ETHYLENE GLYCOL BY WEIGHT		5%	10%	15%	20%	25%	30%	35%	40%	45%	50%
Freezing temperature	°C	-2	-3,9	-6,5	-8,9	-11,8	-15,6	-19,0	-23,4	-27,8	-32,7
Safety temperature	°C	3	1	-1	-4	-6	-10	-14	-19	-23,8	-29,4
Cooling Capacity Factor	Nr	0,997	0,994	0,990	0,986	0,981	0,976	0,970	0,964	0,957	0,950
Compressor power input Factor	Nr	0,999	0,999	0,998	0,997	0,996	0,996	0,995	0,994	0,993	0,993
Internal exchanger pressure drop factor	Nr	1,016	1,035	1,056	1,080	1,106	1,135	1,166	1,200	1,236	1,275

Correction factors for propylene glycol use

% PROPYLENE GLYCOL BY WEIGHT		5%	10%	15%	20%	25%	30%	35%	40%	45%	50%
Freezing temperature	°C	-2	-3,9	-6,5	-8,9	-11,8	-15,6	-19,0	-23,4	-27,8	-32,7
Safety temperature	°C	3	1	-1	-4	-6	-10	-14	-19	-23,8	-29,4
Cooling Capacity Factor	Nr	0,995	0,990	0,983	0,976	0,968	0,960	0,950	0,939	0,928	0,916
Compressor power input Factor	Nr	0,999	0,997	0,995	0,993	0,991	0,988	0,986	0,983	0,980	0,977
Internal exchanger pressure drop factor	Nr	1,027	1,058	1,093	1,133	1,176	1,224	1,276	1,332	1,393	1,457

Fouling Correction Factors

INTERNAL EXCHANGER (EVAPORATOR)

M2 °C/W	F1	FK1
0,44 x 10 (-4)	1,0	1,0
0,88 x 10 (-4)	0,97	0,99
1,76 x 10 (-4)	0,94	0,98

F1 = Cooling capacity correction factors

FK1 = Compressor power input correction factor

Exchanger operating range

INTERNAL EXCHANGER (EVAPORATOR)

		DPR	DPW
Scambiatore a piastre	PED (CE)	4700	1000
Scambiatore a fascio tubiero	PED (CE)	3000	1000

DPr = Maximum operating pressure on refrigerant side in kPa

DPw = Maximum operating pressure on water side in kPa

Overload and control device calibrations

		OPEN	CLOSE	VALUE
High pressure switch	kPa	4230		-
Antifreeze protection	°C	4	5,5	-
High pressure safety valve	kPa	-	-	4700
Low pressure safety valve	kPa	-	-	3000
Max no. of compressor starts per hour	n°	-	-	10
Discharge safety thermostat	°C	-	-	150

General technical data

Operating range - Excellence ST/SC

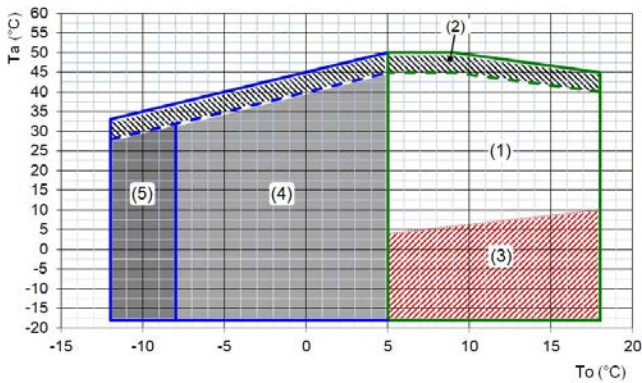

Ta (°C) = external exchanger inlet air temperature (D.B.)
To (°C) = internal exchanger outlet water temperature

1. Standard unit operating range at full load
2. Unit operating range with automatic staging of the compressor capacity
3. Standard unit operating range with air flow automatic modulation
4. Unit operating range in 'B - Low water temperature' configuration
5. Extended of operating range (extremely low water temperature option available on request)

Operating range - Excellence EN

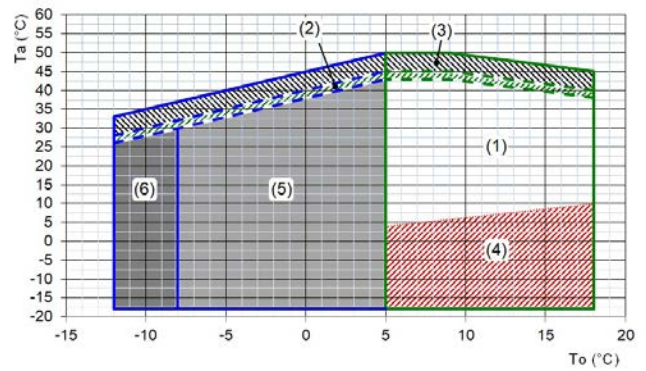

Ta (°C) = external exchanger inlet air temperature (D.B.)
To (°C) = internal exchanger outlet water temperature

1. Standard unit operating range at full load
2. Extended operating range with air flow-rate automatic increasing. Inside this field the sound levels are the same of the 'compressor soundproofing (SC)' acoustic configuration
3. Unit operating range with compressor capacity automatic partialization
4. Standard unit operating range with air flow-rate automatic modulation
5. Unit operating range in 'B - Low water temperature' configuration
6. Extended of operating range (extremely low water temperature option available on request)

Operating range - Premium ST/SC

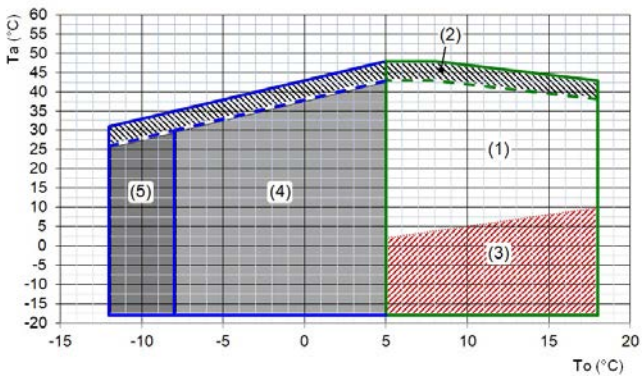

Ta (°C) = external exchanger inlet air temperature (D.B.)
To (°C) = internal exchanger outlet water temperature

1. Standard unit operating range at full load
2. Unit operating range with automatic staging of the compressor capacity
3. Standard unit operating range with air flow automatic modulation
4. Unit operating range in 'B - Low water temperature' configuration
5. Extended of operating range (extremely low water temperature option available on request)

Operating range - Premium EN

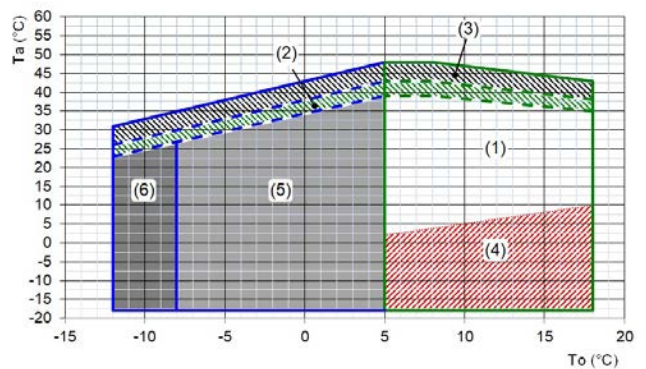

Ta (°C) = external exchanger inlet air temperature (D.B.)
To (°C) = internal exchanger outlet water temperature

1. Standard unit operating range at full load
2. Extended operating range with air flow-rate automatic increasing. Inside this field the sound levels are the same of the 'compressor soundproofing (SC)' acoustic configuration
3. Unit operating range with compressor capacity automatic partialization
4. Standard unit operating range with air flow-rate automatic modulation
5. Unit operating range in 'B - Low water temperature' configuration
6. Extended of operating range (extremely low water temperature option available on request)

Excellence Cooling - ST/SC

SIZE	To (°C)	Entering external exchanger air temperature (°C)											
		25		30		35		40		45		50	
		kWf	kWe	kWf	kWe	kWf	kWe	kWf	kWe	kWf	kWe	kWf	kWe
80.3	5	226	51,6	217	57,0	207	62,9	196	69,5	185	77,0	172	85,5
	6	233	52,1	224	57,5	214	63,5	203	70,2	191	77,8	178	86,3
	7	242	52,8	233	58,3	223	64,3	210	71,0	198	78,6	184	87,1
	10	255	53,7	244	59,2	233	65,3	220	72,1	207	79,7	-	-
	15	291	56,2	279	62,1	267	68,6	253	75,7	238	83,5	-	-
	18	316	58,0	303	64,1	289	70,7	274	78,0	259	86,1	-	-
100.4	5	270	64,5	259	71,0	248	78,2	234	86,2	221	94,9	116	45,5
	6	279	65,2	268	71,8	256	79,1	242	87,1	228	96,0	122	45,9
	7	289	66,2	278	72,9	267	80,3	251	88,4	236	97,4	125	46,2
	10	305	67,6	292	74,4	279	81,9	263	90,1	247	99,1	-	-
	15	345	71,3	331	78,5	316	86,4	299	95,1	281	105	-	-
	18	372	73,9	357	81,4	341	89,5	322	98,4	303	108	-	-
115.4	5	317	74,8	305	82,4	292	90,9	276	100	260	111	196	92,8
	6	328	75,6	315	83,3	301	91,9	285	101	268	112	204	93,6
	7	340	76,7	327	84,5	315	93,2	296	103	278	114	211	94,5
	10	359	78,3	345	86,2	329	95,0	310	105	291	116	-	-
	15	406	82,4	391	90,8	374	100	353	110	332	122	-	-
	18	439	85,4	422	94,0	403	104	381	114	359	126	-	-
130.4	5	368	85,8	353	94,6	337	104	320	115	300	128	233	111
	6	381	86,7	365	95,6	349	106	330	117	311	129	242	112
	7	394	87,8	378	96,8	364	107	342	118	322	131	251	113
	10	418	89,7	400	98,8	381	109	360	120	338	133	-	-
	15	472	94,3	453	104	432	115	410	126	386	140	-	-
	18	510	97,6	489	108	468	118	444	131	417	144	-	-
155.5	5	431	100	414	111	395	122	374	135	352	150	282	136
	6	445	102	427	112	408	124	387	137	364	151	291	137
	7	460	103	441	113	424	125	400	138	377	153	302	138
	10	495	106	474	116	452	128	427	142	401	156	-	-
	15	558	111	535	122	511	135	485	149	456	164	-	-
	18	604	115	580	127	553	139	525	154	494	169	-	-
170.5	5	480	111	461	123	439	135	415	150	390	167	323	151
	6	496	112	475	124	453	137	429	152	403	168	336	153
	7	514	114	494	126	472	139	446	154	419	171	349	154
	10	548	117	524	129	499	142	472	157	442	174	-	-
	15	626	123	600	136	572	150	541	165	509	183	-	-
	18	677	128	650	141	619	155	586	171	496	152	-	-
185.5	5	525	125	504	138	480	152	453	169	424	187	354	174
	6	542	126	520	139	495	154	468	170	439	189	367	176
	7	564	128	541	141	520	156	487	173	456	192	381	178
	10	597	131	571	145	543	159	513	176	481	195	-	-
	15	683	139	655	153	624	169	590	186	553	206	-	-
	18	739	145	708	159	675	175	638	193	544	176	-	-
210.6	5	584	137	560	151	534	167	504	185	472	206	399	195
	6	603	139	578	153	550	169	520	187	487	208	414	197
	7	625	141	600	155	574	171	541	190	507	210	430	199
	10	665	144	636	159	605	175	570	193	535	214	-	-
	15	759	153	727	168	693	185	655	205	615	226	-	-
	18	820	159	787	175	749	192	709	212	611	197	-	-

Performances

Excellence

Cooling - ST/SC

SIZE	To (°C)	Entering external exchanger air temperature (°C)											
		25		30		35		40		45		50	
		kWf	kWe	kWf	kWe	kWf	kWe	kWf	kWe	kWf	kWe	kWf	kWe
225.6	5	651	151	625	166	596	184	564	203	527	226	448	217
	6	669	152	640	168	610	185	576	205	539	228	458	218
	7	680	153	651	169	624	186	586	206	548	229	465	219
	10	701	155	670	171	638	188	602	208	563	231	-	-
	15	799	163	764	180	728	199	687	220	642	243	-	-
	18	867	170	830	188	791	207	746	229	697	254	-	-
240.6	5	697	165	671	182	639	201	600	223	559	248	455	215
	6	718	167	686	184	655	203	613	225	572	250	466	216
	7	732	168	698	185	676	204	624	226	582	251	474	217
	10	752	170	717	187	690	206	641	228	598	254	-	-
	15	855	179	816	197	779	218	730	241	578	203	-	-
	18	923	187	886	206	843	227	792	251	623	209	-	-

kWf = Cooling capacity in kW

kWe = Compressor power input in kW

To (°C) = Internal exchanger outlet water temperature (evaporator)

Performances in function of the inlet/outlet water temperature differential = 5°C

Excellence Cooling - EN

SIZE	To (°C)	Entering external exchanger air temperature (°C)											
		25		30		35		40		45		50	
		kWf	kWe	kWf	kWe	kWf	kWe	kWf	kWe	kWf	kWe	kWf	kWe
80.3	5	222	54,1	212	59,7	202	65,9	191	72,8	185	77,0	172	85,5
	6	228	54,7	219	60,3	209	66,6	197	73,6	191	77,8	178	86,3
	7	237	55,5	227	61,2	217	67,5	205	74,6	198	78,6	184	87,1
	10	249	56,6	238	62,3	226	68,7	214	75,7	207	79,7	-	-
	15	284	59,7	272	65,8	259	72,5	245	80,0	238	83,5	-	-
	18	307	61,8	294	68,2	280	75,1	265	82,8	259	86,1	-	-
100.4	5	266	68,7	255	75,6	243	83,2	229	91,6	223	95,7	118	45,9
	6	274	69,6	263	76,6	251	84,3	237	92,7	230	96,8	123	46,3
	7	284	70,8	273	77,9	262	85,7	245	94,2	239	98,2	126	46,6
	10	299	72,5	286	79,6	272	87,5	256	96,1	249	100	-	-
	15	337	77,0	323	84,6	308	93,0	290	102	284	105	-	-
	18	363	80,2	347	88,1	331	96,7	312	106	306	109	-	-
115.4	5	310	78,8	298	86,8	284	95,7	268	106	260	111	196	92,8
	6	320	79,8	307	87,9	293	96,9	277	107	268	112	204	93,6
	7	332	81,0	319	89,2	306	98,4	287	109	278	114	211	94,5
	10	350	82,9	335	91,2	319	100	300	111	291	116	-	-
	15	395	87,9	379	96,7	361	106	341	117	332	122	-	-
	18	425	91,5	408	101	389	111	367	122	359	126	-	-
130.4	5	360	90,2	345	99,4	329	110	311	121	300	128	233	111
	6	372	91,3	357	101	339	111	321	123	311	129	242	112
	7	385	92,6	369	102	355	113	332	124	322	131	251	113
	10	407	94,8	389	104	370	115	349	127	338	133	-	-
	15	459	100	440	110	419	122	396	134	386	140	-	-
	18	495	104	474	115	452	126	428	139	417	144	-	-
155.5	5	417	104	400	115	381	127	360	140	349	148	279	134
	6	431	105	413	116	393	128	372	142	360	149	289	135
	7	445	107	426	118	409	130	385	144	373	151	299	136
	10	477	110	456	121	434	133	409	147	397	154	-	-
	15	537	116	515	128	490	141	464	156	452	162	-	-
	18	580	121	556	133	529	147	500	161	489	167	-	-
170.5	5	469	117	450	129	427	143	403	158	390	167	323	151
	6	484	119	463	131	441	144	416	160	403	168	336	153
	7	503	120	482	133	459	147	432	163	419	171	349	154
	10	533	124	510	136	484	150	456	166	442	174	-	-
	15	608	132	582	145	553	160	521	176	509	183	-	-
	18	656	137	628	151	597	166	563	183	496	152	-	-
185.5	5	513	132	490	145	466	161	438	178	424	187	354	174
	6	529	133	506	147	480	163	452	180	439	189	367	176
	7	550	136	526	150	504	165	470	183	456	192	381	178
	10	580	139	554	153	526	169	495	187	481	195	-	-
	15	663	149	634	164	601	181	567	199	553	206	-	-
	18	715	155	683	171	649	188	638	193	544	176	-	-
210.6	5	570	146	546	161	518	178	488	197	472	207	399	197
	6	588	148	562	163	534	180	502	200	487	209	414	199
	7	610	150	584	166	556	183	523	203	507	212	430	201
	10	647	154	617	170	585	187	550	207	535	216	-	-
	15	736	165	703	181	668	200	629	220	615	228	-	-
	18	793	172	759	189	721	208	655	224	611	199	-	-

Performances

Excellence

Cooling - EN

SIZE	To (°C)	Entering external exchanger air temperature (°C)											
		25		30		35		40		45		50	
		kWf	kWe	kWf	kWe	kWf	kWe	kWf	kWe	kWf	kWe	kWf	kWe
225.6	5	629	159	603	175	573	194	540	215	522	226	444	217
	6	646	161	617	177	586	196	552	217	534	228	454	218
	7	657	162	627	178	599	197	561	218	542	229	461	219
	10	676	164	645	181	612	199	576	220	558	231	-	-
	15	770	173	735	191	698	210	656	233	636	243	-	-
	18	836	180	799	199	758	219	713	242	691	254	-	-
240.6	5	672	175	646	193	617	214	578	237	556	248	449	215
	6	689	177	661	195	630	216	590	239	569	250	460	216
	7	704	178	673	197	646	217	599	241	579	251	469	217
	10	723	181	691	199	656	220	615	244	595	254	-	-
	15	819	191	785	210	748	232	701	257	675	263	-	-
	18	887	199	852	219	813	242	761	268	720	269	-	-

kWf = Cooling capacity in kW

kWe = Compressor power input in kW

To (°C) = Internal exchanger outlet water temperature (evaporator)

Performances in function of the inlet/outlet water temperature differential = 5°C

Premium Cooling - ST/SC

SIZE	To (°C)	Entering external exchanger air temperature (°C)											
		25		30		35		40		45		48	
		kWf	kWe	kWf	kWe	kWf	kWe	kWf	kWe	kWf	kWe	kWf	kWe
90.3	5	238	64,3	228	70,9	217	78,3	204	86,6	196	92,1	144	67,1
	6	246	65,2	235	71,9	223	79,3	210	87,7	202	93,3	150	67,9
	7	254	66,2	243	72,9	232	80,5	217	89,0	208	94,6	154	68,5
	10	269	68,1	256	74,9	243	82,5	228	91,1	219	96,7	-	-
	15	302	72,3	288	79,6	274	87,6	258	96,6	199	66,3	-	-
	18	325	75,5	310	83,0	295	91,3	263	97,5	216	68,5	-	-
110.4	5	297	77,3	284	85,2	271	94,0	255	104	246	110	198	94,3
	6	306	78,2	293	86,2	279	95,1	263	105	253	112	205	95,3
	7	317	79,4	304	87,5	291	96,6	273	107	263	113	212	96,4
	10	335	81,5	320	89,7	304	98,7	286	109	275	115	-	-
	15	377	86,2	361	94,8	343	104	324	115	271	93,3	-	-
	18	406	89,7	389	98,7	370	109	349	119	293	96,4	-	-
130.4	5	343	94,0	327	104	311	115	291	127	279	135	182	81,1
	6	353	95,3	337	105	320	116	300	128	288	137	190	81,9
	7	366	97,0	349	107	333	118	311	131	298	139	195	82,5
	10	385	100	367	110	347	121	325	133	311	142	-	-
	15	432	106	412	117	391	129	367	142	254	79,2	-	-
	18	465	111	443	122	421	134	367	142	275	81,8	-	-
145.4	5	394	105	377	116	358	128	336	142	322	151	260	133
	6	406	106	388	117	369	129	347	143	333	153	269	134
	7	421	108	402	119	385	131	360	146	345	155	203	81,2
	10	444	111	424	122	402	134	377	149	361	158	-	-
	15	499	118	477	130	454	143	427	158	360	130	-	-
	18	538	123	514	135	489	149	446	161	389	135	-	-
170.5	5	456	118	436	130	415	144	390	160	374	170	287	132
	6	470	120	450	132	428	146	403	162	386	172	297	134
	7	486	121	464	134	444	148	415	164	399	175	309	135
	10	522	126	498	138	472	152	443	169	425	179	-	-
	15	585	133	559	146	531	161	500	178	399	131	-	-
	18	630	139	603	152	573	168	539	185	432	135	-	-
185.5	5	497	136	474	150	451	166	422	184	404	196	273	124
	6	513	138	490	152	465	168	436	186	417	199	284	126
	7	530	140	506	154	484	171	452	189	433	202	294	127
	10	565	144	538	159	510	175	478	194	457	206	-	-
	15	639	155	609	170	578	187	543	207	386	122	-	-
	18	687	162	656	178	623	195	569	212	418	126	-	-
210.6	5	551	150	526	166	500	183	469	204	449	217	382	203
	6	568	152	543	168	515	186	483	206	463	219	395	205
	7	588	155	562	171	538	189	503	209	482	223	386	184
	10	626	160	597	176	565	194	529	214	468	191	-	-
	15	708	171	676	188	641	207	558	190	536	202	-	-
	18	762	179	727	196	691	216	602	198	578	210	-	-

Performances

Premium Cooling - ST/SC

SIZE	To (°C)	Entering external exchanger air temperature (°C)											
		25		30		35		40		45		48	
		kWf	kWe	kWf	kWe	kWf	kWe	kWf	kWe	kWf	kWe	kWf	kWe
225.6	5	603	158	577	174	549	192	505	221	494	228	396	196
	6	622	160	595	176	565	195	521	223	510	230	411	198
	7	645	162	617	179	591	198	541	227	530	234	426	201
	10	686	167	654	184	620	203	569	232	558	239	-	-
	15	778	178	744	196	707	216	649	248	556	194	-	-
	18	839	186	802	205	763	225	717	248	601	201	-	-
240.6	5	648	176	619	194	594	215	550	239	527	255	364	167
	6	670	178	641	197	614	218	569	242	545	258	380	168
	7	698	181	666	200	644	222	593	246	568	262	393	170
	10	741	187	705	206	673	227	624	252	598	268	-	-
	15	837	200	800	220	766	243	712	268	514	164	-	-
	18	898	209	858	230	823	253	764	279	555	169	-	-

kWf = Cooling capacity in kW

kWe = Compressor power input in kW

To (°C) = Internal exchanger outlet water temperature (evaporator)

Performances in function of the inlet/outlet water temperature differential = 5°C

Premium Cooling - EN

SIZE		Entering external exchanger air temperature (°C)												
		To (°C)	25		30		35		40		45		48	
			kWf	kWe	kWf	kWe	kWf	kWe	kWf	kWe	kWf	kWe	kWf	kWe
90.3	5	235	66,4	224	73,2	213	80,9	199	89,5	196	92,1	144	67,1	
	6	242	67,4	231	74,3	219	82,0	206	90,7	202	93,3	150	67,9	
	7	250	68,5	238	75,4	228	83,3	212	92,1	208	94,6	154	68,5	
	10	264	70,5	251	77,6	238	85,5	223	94,1	219	96,7	-	-	
	15	296	75,2	282	82,7	268	91,0	203	64,5	199	66,3	-	-	
	18	318	78,7	303	86,4	288	95,0	220	66,6	216	68,5	-	-	
110.4	5	290	79,6	277	87,7	264	96,8	248	107	243	110	196	94,3	
	6	299	80,6	286	88,8	272	98,0	256	108	251	112	203	95,3	
	7	310	81,9	296	90,3	283	100	265	110	260	113	210	96,4	
	10	327	84,1	312	92,6	296	102	278	112	272	115	-	-	
	15	367	89,3	351	98,3	333	108	274	90,6	269	93,3	-	-	
	18	395	93,2	377	102	359	113	296	93,6	290	96,4	-	-	
130.4	5	340	98,2	324	108	307	120	287	133	282	136	184	81,9	
	6	351	100	334	110	316	121	296	134	290	138	191	82,7	
	7	363	102	346	112	329	124	306	137	301	140	197	83,3	
	10	382	104	363	115	342	127	320	140	314	143	-	-	
	15	428	112	407	123	385	135	261	78,0	257	80,0	-	-	
	18	459	117	437	129	413	142	283	80,5	278	82,6	-	-	
145.4	5	385	107	367	118	348	131	326	145	319	150	257	131	
	6	397	109	378	120	359	132	337	147	330	151	266	133	
	7	410	110	392	122	374	135	349	149	342	154	201	80,4	
	10	433	113	412	125	390	138	365	152	357	156	-	-	
	15	486	121	464	133	440	147	364	126	357	129	-	-	
	18	523	127	498	139	473	153	394	130	386	134	-	-	
170.5	5	445	122	425	134	404	149	379	165	371	170	284	132	
	6	459	123	439	136	417	151	391	167	383	172	294	134	
	7	474	125	453	138	432	153	404	169	396	175	306	135	
	10	509	130	485	143	459	158	430	174	421	179	-	-	
	15	570	138	544	152	516	167	404	127	396	131	-	-	
	18	613	144	585	158	556	174	437	131	428	135	-	-	
185.5	5	489	141	466	156	442	172	413	191	404	197	273	125	
	6	504	143	481	158	455	175	426	194	417	200	284	126	
	7	521	146	497	161	474	178	441	197	433	203	294	128	
	10	555	151	528	166	499	183	466	202	457	207	-	-	
	15	626	162	596	178	564	196	393	119	386	123	-	-	
	18	673	170	640	186	606	205	426	123	418	127	-	-	
210.6	5	543	155	517	171	490	190	459	211	449	217	382	203	
	6	559	158	533	174	505	192	473	213	463	219	395	205	
	7	578	160	552	177	527	196	491	217	482	223	386	184	
	10	615	166	585	182	552	201	477	186	468	191	-	-	
	15	694	178	661	196	626	215	546	197	536	202	-	-	
	18	746	186	711	205	652	220	590	204	578	210	-	-	

Performances

Premium Cooling - EN

SIZE	To (°C)	Entering external exchanger air temperature (°C)											
		25		30		35		40		45		48	
		kWf	kWe	kWf	kWe	kWf	kWe	kWf	kWe	kWf	kWe	kWf	kWe
225.6	5	595	163	568	179	539	199	505	221	494	228	396	196
	6	613	165	586	182	555	201	521	223	510	230	411	198
	7	636	168	608	185	580	205	541	227	530	234	426	201
	10	674	173	642	190	608	210	570	232	558	239	-	-
	15	764	185	730	204	692	224	568	188	556	194	-	-
	18	823	194	785	213	745	234	614	195	601	201	-	-
240.6	5	633	182	605	201	575	223	535	248	523	255	360	167
	6	655	184	626	204	594	225	553	251	540	258	375	168
	7	678	188	649	207	623	230	575	255	561	262	388	170
	10	719	194	685	213	649	236	605	260	591	268	-	-
	15	814	208	778	229	739	253	521	159	509	164	-	-
	18	873	218	834	240	792	264	563	164	551	169	-	-

kWf = Cooling capacity in kW

kWe = Compressor power input in kW

To (°C) = Internal exchanger outlet water temperature (evaporator)

Performances in function of the inlet/outlet water temperature differential = 5°C

Excellence

Plate exchangers pressure drop (EVPHE) - Size 80.3 ÷ 130.4

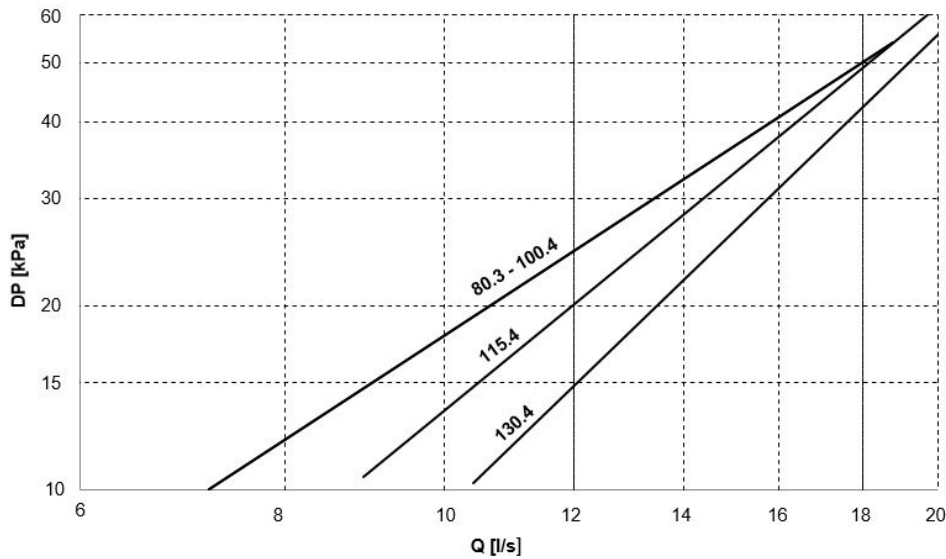

The pressure drops are calculated considering a water temperature of 7°C

Q = Water flow-rate [l/s]
DP = Water side pressure drops [kPa]

The water flow-rate must be calculated with the following formula

$$Q [l/s] = kWf / (4,186 \times DT)$$

kWf = Cooling capacity in kW
DT = Temperature difference between inlet / outlet water

Admissible water flow-rates

Minimum (Qmin) and maximum (Qmax) admissible water flow for the unit to operate correctly

SIZE		80.3	100.4	115.4	130.4
Qmin	[l/s]	7,2	7,2	8,9	10,4
Qmax	[l/s]	18,8	18,8	20,0	20,0

Plate exchangers pressure drop (EVPHE) - Size 155.5 ÷ 240.6

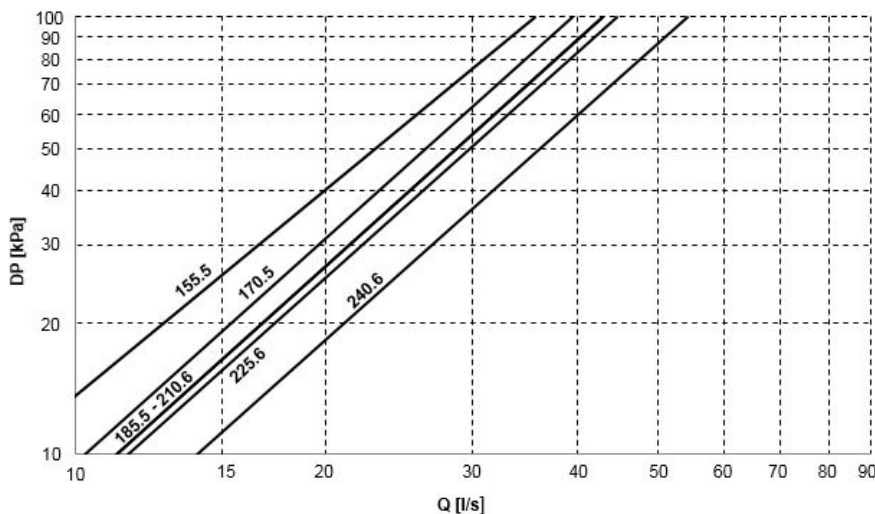

The pressure drops are calculated considering a water temperature of 7°C

Q = Water flow-rate [l/s]
DP = Water side pressure drops [kPa]

The water flow-rate must be calculated with the following formula

$$Q [l/s] = kWf / (4,186 \times DT)$$

kWf = Cooling capacity in kW
DT = Temperature difference between inlet / outlet water

Admissible water flow-rates

Minimum (Qmin) and maximum (Qmax) admissible water flow for the unit to operate correctly

SIZE		155.5	170.5	185.5	210.6	225.6	240.6
Qmin	[l/s]	8,2	10,3	11,2	11,2	11,6	14,0
Qmax	[l/s]	35,5	39,5	42,8	42,8	44,6	54,2

Performances

Premium

Plate exchangers pressure drop (EVPHE) - Size 90.3 ÷ 145.4

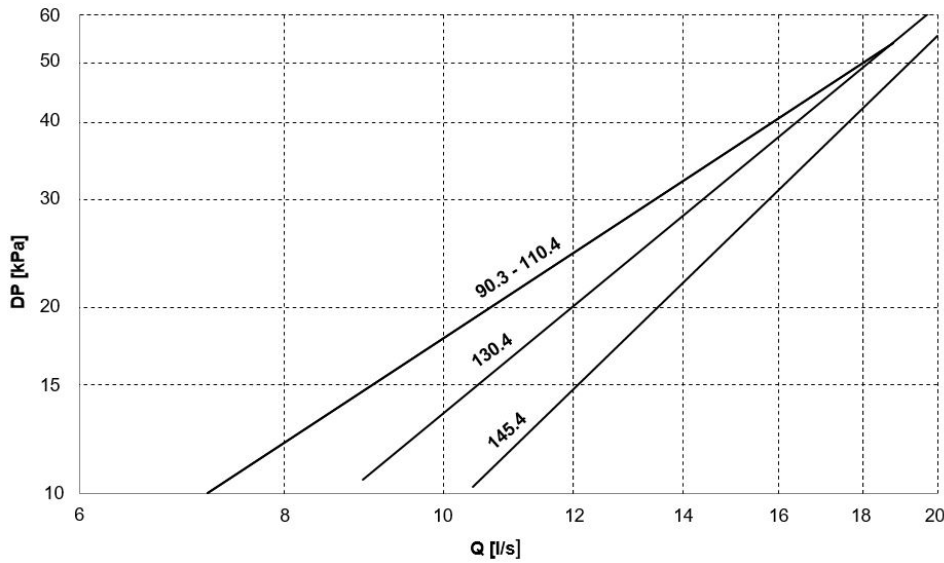

The pressure drops are calculated considering a water temperature of 7°C

Q = Water flow-rate[l/s]
DP = Water side pressure drops [kPa]

The water flow-rate must be calculated with the following formula

$$Q [l/s] = kWf / (4,186 \times DT)$$

kWf = Cooling capacity in kW
DT = Temperature difference between inlet / outlet water

Admissible water flow-rates

Minimum (Qmin) and maximum (Qmax) admissible water flow for the unit to operate correctly

SIZE		90.3	110.4	130.4	145.4
Qmin	[l/s]	7,2	7,2	8,9	10,4
Qmax	[l/s]	18,8	18,8	20,0	20,0

Plate exchangers pressure drop (EVPHE) - Size 170.5 ÷ 240.6

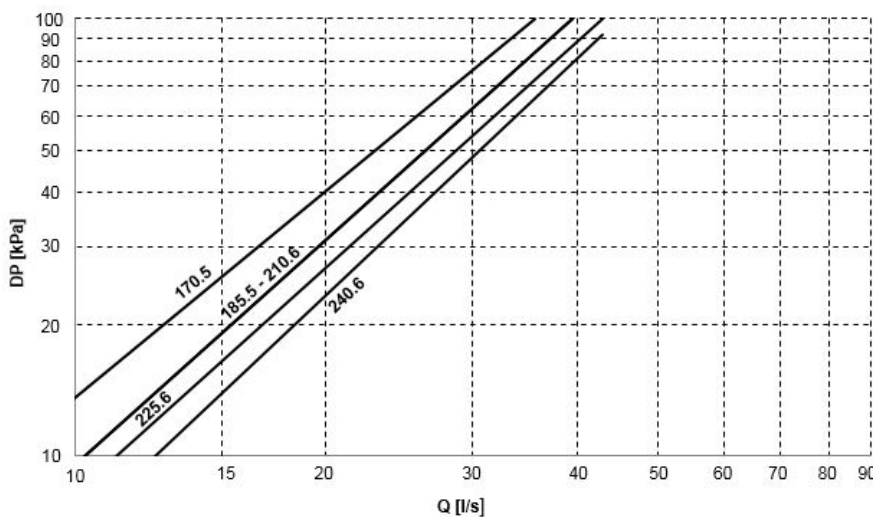

The pressure drops are calculated considering a water temperature of 7°C

Q = Water flow-rate[l/s]
DP = Water side pressure drops [kPa]

The water flow-rate must be calculated with the following formula

$$Q [l/s] = kWf / (4,186 \times DT)$$

kWf = Cooling capacity in kW
DT = Temperature difference between inlet / outlet water

Admissible water flow-rates

Minimum (Qmin) and maximum (Qmax) admissible water flow for the unit to operate correctly

SIZE		170.5	185.5	210.6	225.6	240.6
Qmin	[l/s]	8,2	10,3	10,3	11,2	12,5
Qmax	[l/s]	35,5	39,5	39,5	42,8	42,8

Excellence

Cooling at part load - ST/SC

SIZE	Load	Entering external exchanger air temperature (°C)											
		35°C			30°C			25°C			20°C		
		kWf	kWe_tot	EER	kWf	kWe_tot	EER	kWf	kWe_tot	EER	kWf	kWe_tot	EER
80.3	100	223	68,9	3,23	233	62,9	3,70	242	57,4	4,22	253	52,3	4,84
	75	167	49,9	3,34	174	45,5	3,83	182	41,5	4,38	190	37,7	5,04
	50	111	31,9	3,49	116	29,1	4,00	121	26,5	4,57	127	24,1	5,25
	25	55,6	15,1	3,69	58,1	13,7	4,25	60,5	12,3	4,91	63,3	11,0	5,76
	Minimum	45,4	12,0	3,79	47,3	10,8	4,38	49,3	9,70	5,08	51,6	8,60	6,02
100.4	100	267	84,8	3,15	278	77,4	3,59	289	70,7	4,09	305	64,6	4,73
	75	200	60,2	3,33	209	55,0	3,79	217	50,3	4,31	229	46,1	4,97
	50	134	35,2	3,80	139	32,2	4,31	145	29,5	4,89	153	27,1	5,63
	25	72,2	19,0	3,80	74,9	17,4	4,31	77,7	15,9	4,89	81,8	14,5	5,63
	Minimum	72,2	19,0	3,80	74,9	17,4	4,31	77,7	15,9	4,89	81,8	14,5	5,63
115.4	100	315	98,9	3,18	327	90,2	3,63	340	82,4	4,13	359	75,2	4,76
	75	236	71,3	3,31	245	65,1	3,77	255	59,5	4,28	269	54,3	4,95
	50	157	41,2	3,82	164	37,7	4,34	170	34,5	4,92	179	31,6	5,67
	25	78,7	19,8	3,98	81,6	18,0	4,52	84,5	16,5	5,13	88,9	15,0	5,92
	Minimum	73,8	18,5	4,00	76,5	16,8	4,54	79,2	15,4	5,16	83,3	14,0	5,95
130.4	100	364	114	3,20	378	104	3,64	394	94,8	4,15	414	86,6	4,79
	75	273	82,0	3,33	284	74,9	3,79	295	68,4	4,32	311	62,3	4,99
	50	182	50,7	3,60	189	46,3	4,09	197	42,2	4,66	207	38,4	5,39
	25	91,1	25,1	3,62	94,6	22,9	4,13	98,5	20,9	4,72	104	19,0	5,45
	Minimum	72,0	19,8	3,64	74,8	18,0	4,15	77,9	16,4	4,74	82,0	15,0	5,48
155.5	100	424	133	3,18	441	121	3,63	460	111	4,15	483	101	4,77
	75	318	92,1	3,45	331	84,5	3,92	345	77,6	4,45	362	71,1	5,10
	50	212	54,9	3,86	221	50,3	4,38	230	46,0	5,00	242	42,0	5,76
	25	106	25,8	4,11	110	23,5	4,67	114	21,5	5,32	120	19,6	6,12
	Minimum	76,4	17,7	4,32	79,2	16,1	4,92	82,2	14,6	5,61	85,8	13,3	6,44
170.5	100	472	148	3,19	494	135	3,66	514	123	4,18	537	112	4,78
	75	354	104	3,42	370	94,6	3,92	386	86,4	4,46	403	78,8	5,12
	50	236	60,6	3,90	247	55,4	4,46	257	50,5	5,09	269	45,8	5,87
	25	118	29,2	4,04	123	26,6	4,63	128	24,3	5,29	134	22,0	6,07
	Minimum	75,3	17,8	4,22	78,5	16,2	4,84	81,5	14,7	5,53	84,9	13,4	6,33
185.5	100	520	165	3,15	541	151	3,59	564	137	4,10	594	125	4,73
	75	390	120	3,26	406	109	3,71	423	100	4,24	445	90,9	4,90
	50	260	67,6	3,85	270	62,0	4,36	282	56,7	4,98	297	51,5	5,76
	25	130	32,5	4,00	135	29,8	4,54	141	27,1	5,18	148	24,7	5,99
	Minimum	76,1	18,0	4,23	78,8	16,4	4,81	81,9	14,9	5,49	85,8	13,6	6,33
210.6	100	574	182	3,16	600	165	3,63	625	151	4,15	653	138	4,75
	75	430	124	3,48	450	113	3,98	469	103	4,53	490	94,5	5,19
	50	287	75,3	3,81	300	68,9	4,36	313	62,9	4,97	327	57,1	5,72
	25	143	35,9	4,00	150	32,8	4,57	156	29,9	5,21	163	27,2	5,98
	Minimum	75,7	17,3	4,38	78,8	15,7	5,01	81,7	14,3	5,71	85,0	13,0	6,53
225.6	100	624	198	3,16	651	180	3,61	680	165	4,13	716	150	4,76
	75	468	137	3,42	488	126	3,88	510	115	4,42	537	106	5,09
	50	312	85,0	3,67	326	78,1	4,17	340	71,5	4,76	358	65,2	5,49
	25	156	40,8	3,82	162	37,4	4,35	169	34,2	4,96	178	31,1	5,72
	Minimum	75,0	17,8	4,21	77,8	16,2	4,79	80,8	14,7	5,48	84,5	13,4	6,30
240.6	100	676	215	3,14	698	196	3,56	732	179	4,09	779	164	4,76
	75	507	144	3,51	523	132	3,96	549	121	4,52	584	111	5,27
	50	338	86,3	3,91	349	79,3	4,40	366	72,7	5,03	390	66,3	5,87
	25	169	41,1	4,11	174	37,6	4,62	181	34,3	5,29	193	31,1	6,19
	Minimum	127	29,9	4,25	130	27,2	4,78	136	24,8	5,47	144	22,4	6,43

Load = % of cooling capacity compared to the value at full load

kWf = cooling capacity in kW

kWe_tot = unit total power input in kW

Internal exchanger water temperature = leaving 7°C / entering 12°C / variable flow-rate with external exchanger air temperature

Performances

Excellence

Cooling at part load- EN

		Entering external exchanger air temperature (°C)											
SIZE	Load	35°C			30°C			25°C			20°C		
		kWf	kWe_tot	EER	kWf	kWe_tot	EER	kWf	kWe_tot	EER	kWf	kWe_tot	EER
80.3	100	217	70,1	3,10	227	63,8	3,57	237	58,1	4,09	248	52,8	4,70
	75	163	50,2	3,24	171	45,6	3,74	178	41,5	4,29	186	37,7	4,94
	50	108	31,5	3,45	114	28,7	3,96	119	26,2	4,53	124	23,9	5,21
	25	54,2	14,7	3,69	56,7	13,3	4,25	59,1	12,0	4,91	61,8	10,7	5,76
	Minimum	45,4	12,0	3,79	47,3	10,8	4,38	49,3	9,70	5,08	51,6	8,60	6,02
100.4	100	262	88,2	2,97	273	80,4	3,40	284	73,3	3,88	301	66,8	4,50
	75	196	60,8	3,23	205	55,7	3,68	213	50,9	4,19	226	46,6	4,84
	50	131	34,5	3,79	136	31,6	4,31	142	29,0	4,91	150	26,6	5,66
	25	72,5	19,1	3,79	75,2	17,4	4,31	78,0	15,9	4,90	82,2	14,5	5,66
	Minimum	72,5	19,1	3,79	75,2	17,4	4,31	78,0	15,9	4,90	82,2	14,5	5,66
115.4	100	306	102	3,01	319	92,4	3,45	332	84,2	3,94	351	76,8	4,57
	75	229	71,9	3,19	239	65,6	3,64	249	59,9	4,16	263	54,6	4,82
	50	153	39,9	3,83	159	36,6	4,35	166	33,5	4,95	175	30,7	5,70
	25	76,5	19,2	3,99	79,3	17,5	4,53	82,1	16,0	5,15	86,4	14,6	5,93
	Minimum	73,8	18,5	4,00	76,5	16,8	4,54	79,2	15,4	5,16	83,3	14,0	5,95
130.4	100	355	116	3,04	369	106	3,48	385	96,5	3,99	406	87,9	4,61
	75	266	82,4	3,23	277	75,1	3,68	289	68,5	4,21	304	62,4	4,87
	50	177	50,5	3,51	184	46,1	4,01	193	42,0	4,58	203	38,2	5,31
	25	88,6	24,6	3,60	92,1	22,4	4,10	96,0	20,5	4,69	101	18,6	5,43
	Minimum	72,0	19,8	3,64	74,8	18,0	4,15	77,9	16,4	4,74	82,0	15,0	5,48
155.5	100	409	134	3,04	426	122	3,49	445	111	4,00	468	101	4,62
	75	306	89,6	3,42	320	82,1	3,89	334	75,3	4,44	351	68,9	5,10
	50	204	52,5	3,89	213	48,2	4,42	223	44,1	5,04	234	40,3	5,82
	25	102	24,6	4,15	106	22,5	4,72	110	20,5	5,37	116	18,7	6,18
	Minimum	75,7	17,4	4,35	78,4	15,8	4,95	81,4	14,4	5,64	85,0	13,1	6,47
170.5	100	459	152	3,02	482	138	3,49	503	126	4,01	526	114	4,60
	75	345	103	3,34	361	94,2	3,83	377	86,1	4,38	394	78,4	5,03
	50	230	58,7	3,92	241	53,8	4,48	251	49,2	5,11	263	44,7	5,88
	25	115	28,3	4,06	120	25,8	4,65	125	23,6	5,30	131	21,4	6,09
	Minimum	75,3	17,8	4,22	78,5	16,2	4,84	81,5	14,7	5,53	84,9	13,4	6,33
185.5	100	504	171	2,96	526	155	3,40	550	141	3,90	580	128	4,52
	75	378	121	3,13	395	110	3,58	412	101	4,10	435	91,7	4,75
	50	252	65,1	3,88	263	59,9	4,39	275	55,0	5,00	290	50,1	5,80
	25	126	31,4	4,02	131	28,7	4,56	137	26,3	5,20	144	23,9	6,01
	Minimum	76,1	18,0	4,23	78,8	16,4	4,81	81,9	14,9	5,49	85,8	13,6	6,33
210.6	100	556	189	2,95	584	171	3,41	610	156	3,91	639	142	4,49
	75	417	123	3,39	438	113	3,89	458	103	4,44	479	94,1	5,09
	50	278	73,3	3,80	292	67,4	4,34	305	61,7	4,95	319	56,1	5,69
	25	139	34,9	3,98	146	32,0	4,55	152	29,2	5,19	158	26,6	5,96
	Minimum	75,7	17,4	4,34	78,8	15,9	4,97	81,7	14,4	5,66	85,0	13,1	6,47
225.6	100	599	203	2,95	627	185	3,39	657	168	3,90	693	153	4,51
	75	450	135	3,32	470	124	3,79	492	114	4,33	519	104	4,99
	50	300	82,3	3,64	314	75,8	4,14	328	69,6	4,72	346	63,6	5,45
	25	150	39,4	3,80	156	36,2	4,32	163	33,1	4,93	172	30,2	5,68
	Minimum	74,3	17,8	4,17	77,0	16,2	4,75	80,0	14,7	5,42	83,7	13,4	6,24
240.6	100	646	224	2,89	673	203	3,32	704	185	3,81	751	168	4,46
	75	484	143	3,39	505	131	3,85	528	120	4,39	563	110	5,12
	50	323	82,8	3,90	336	76,5	4,40	352	70,3	5,00	376	64,3	5,85
	25	161	39,4	4,09	167	36,1	4,62	174	33,0	5,26	185	29,9	6,17
	Minimum	126	29,9	4,21	130	27,2	4,76	134	24,8	5,42	142	22,4	6,37

Load = % of cooling capacity compared to the value at full load

kWf = cooling capacity in kW

kWe_tot = unit total power input in kW

Internal exchanger water temperature = leaving 7°C / entering 12°C / variable flow-rate with external exchanger air temperature

Premium Cooling at part load - ST/SC

SIZE	Load	Entering external exchanger air temperature (°C)											
		35°C			30°C			25°C			20°C		
		kWf	kWe_tot	EER	kWf	kWe_tot	EER	kWf	kWe_tot	EER	kWf	kWe_tot	EER
90.3	100	232	83,9	2,76	243	76,4	3,18	254	69,6	3,65	267	63,5	4,21
	75	174	54,2	3,21	182	49,7	3,66	190	45,6	4,18	200	41,7	4,81
	50	116	33,4	3,48	121	30,6	3,96	127	28,1	4,52	134	25,7	5,20
	30	71,3	19,3	3,70	74,1	17,6	4,21	77,2	16,1	4,80	80,9	14,7	5,52
	Minimum	71,3	19,3	3,70	74,1	17,6	4,21	77,2	16,1	4,80	80,9	14,7	5,52
110.4	100	291	101	2,88	304	92,2	3,29	317	84,1	3,77	333	76,7	4,35
	75	218	69,3	3,15	228	63,4	3,59	238	58,0	4,10	250	53,0	4,72
	50	146	39,9	3,65	152	36,6	4,15	159	33,5	4,73	167	30,7	5,43
	25	72,8	19,4	3,76	75,6	17,6	4,29	78,7	16,1	4,89	82,6	14,7	5,63
	Minimum	58,6	15,4	3,82	60,8	14,0	4,35	63,2	12,7	4,98	66,2	11,5	5,74
130.4	100	333	123	2,72	349	111	3,14	366	101	3,60	386	92,6	4,17
	75	250	85,3	2,93	262	77,9	3,36	274	71,1	3,86	289	65,0	4,45
	50	167	45,0	3,71	175	41,9	4,17	183	38,6	4,74	193	35,5	5,43
	25	83,3	22,0	3,79	86,7	20,2	4,30	90,4	18,5	4,89	94,9	16,9	5,61
	Minimum	72,6	19,0	3,82	75,4	17,4	4,34	78,4	15,9	4,94	82,2	14,5	5,67
145.4	100	385	137	2,80	402	125	3,23	421	114	3,70	443	104	4,27
	75	289	87,6	3,29	302	80,2	3,77	316	73,3	4,30	332	67,0	4,96
	50	192	51,5	3,73	201	47,3	4,25	210	43,3	4,86	222	39,6	5,59
	25	96,2	25,5	3,78	100	23,3	4,30	104	21,3	4,90	110	19,5	5,63
	Minimum	74,6	19,6	3,81	77,5	17,9	4,33	80,6	16,4	4,93	84,5	15,0	5,65
170.5	100	444	155	2,87	464	141	3,30	486	128	3,79	511	117	4,38
	75	333	103	3,23	348	94,4	3,69	364	86,5	4,21	384	79,2	4,84
	50	222	60,4	3,68	232	55,6	4,18	243	51,0	4,76	256	46,6	5,49
	25	111	29,6	3,74	116	27,2	4,26	121	24,9	4,85	127	22,8	5,58
	Minimum	73,4	19,2	3,82	76,3	17,6	4,34	79,4	16,1	4,94	83,3	14,7	5,67
185.5	100	484	177	2,73	506	161	3,14	530	147	3,61	559	134	4,17
	75	363	107	3,38	380	99,0	3,84	397	91,0	4,36	419	83,6	5,01
	50	242	62,3	3,89	253	57,3	4,42	265	52,6	5,04	279	47,9	5,83
	25	121	30,0	4,03	126	27,5	4,59	131	25,1	5,23	138	22,9	6,04
	Minimum	75,6	17,9	4,22	78,4	16,3	4,81	81,5	14,8	5,50	85,3	13,5	6,33
210.6	100	538	197	2,73	562	179	3,14	588	163	3,61	619	148	4,17
	75	403	126	3,19	422	116	3,64	441	106	4,14	464	97,4	4,76
	50	269	73,1	3,68	281	67,3	4,17	294	61,9	4,75	309	56,5	5,47
	25	134	35,1	3,83	140	32,2	4,35	146	29,5	4,96	154	26,9	5,71
	Minimum	72,7	17,6	4,12	75,4	16,0	4,70	78,3	14,6	5,37	81,9	13,3	6,18
225.6	100	591	207	2,85	617	188	3,28	645	171	3,76	679	156	4,34
	75	443	135	3,28	463	124	3,74	484	114	4,26	509	104	4,90
	50	296	84,9	3,48	309	78,0	3,96	322	71,6	4,50	339	65,6	5,17
	25	148	40,3	3,67	154	36,9	4,17	161	33,8	4,75	169	30,9	5,46
	Minimum	72,8	17,7	4,12	75,5	16,1	4,70	78,4	14,6	5,37	82,1	13,3	6,18
240.6	100	644	231	2,79	666	210	3,18	698	191	3,66	742	174	4,27
	75	483	150	3,23	499	137	3,64	523	126	4,15	557	115	4,82
	50	322	88,7	3,63	333	81,6	4,08	349	74,8	4,66	371	68,3	5,44
	25	161	42,7	3,78	166	39,0	4,25	173	35,6	4,86	184	32,4	5,68
	Minimum	122	31,5	3,87	125	28,7	4,36	130	26,1	5,00	138	23,6	5,86

Load = % of cooling capacity compared to the value at full load

kWf = cooling capacity in kW

kWe_tot = unit total power input in kW

Internal exchanger water temperature = leaving 7°C / entering 12°C / variable flow-rate with external exchanger air temperature

Performances

Premium

Cooling at part load - EN

SIZE	Load	Entering external exchanger air temperature (°C)											
		35°C			30°C			25°C			20°C		
		kWf	kWe_tot	EER	kWf	kWe_tot	EER	kWf	kWe_tot	EER	kWf	kWe_tot	EER
90.3	100	228	85,8	2,65	238	77,9	3,06	250	71,0	3,52	263	64,7	4,07
	75	171	54,1	3,15	179	49,6	3,60	187	45,5	4,12	198	41,6	4,75
	50	114	32,9	3,46	119	30,3	3,94	125	27,8	4,50	132	25,5	5,17
	30	71,3	19,3	3,70	74,1	17,6	4,21	77,2	16,1	4,80	80,9	14,7	5,52
	Minimum	71,3	19,3	3,70	74,1	17,6	4,21	77,2	16,1	4,80	80,9	14,7	5,52
110.4	100	283	103	2,75	296	93,7	3,16	310	85,3	3,63	326	77,8	4,19
	75	213	69,5	3,06	222	63,5	3,50	232	58,1	4,00	245	53,0	4,61
	50	142	39,1	3,62	148	36,0	4,12	155	33,0	4,69	163	30,3	5,39
	25	70,9	19,0	3,73	73,7	17,3	4,25	76,7	15,8	4,85	80,5	14,4	5,59
	Minimum	58,0	15,4	3,78	60,2	14,0	4,31	62,6	12,7	4,93	65,6	11,5	5,68
130.4	100	329	127	2,59	346	115	3,00	363	105	3,46	383	95,6	4,01
	75	247	87,3	2,83	260	79,6	3,26	272	72,7	3,74	287	66,4	4,33
	50	165	44,4	3,71	173	41,1	4,21	181	37,9	4,79	192	34,9	5,49
	25	82,3	21,7	3,79	85,7	19,9	4,31	89,3	18,2	4,91	93,8	16,7	5,63
	Minimum	73,3	19,2	3,82	76,1	17,5	4,34	79,2	16,0	4,94	83,0	14,7	5,67
145.4	100	374	139	2,69	392	126	3,11	410	115	3,58	433	105	4,14
	75	280	86,2	3,25	294	79,0	3,72	308	72,3	4,26	325	66,2	4,91
	50	187	50,1	3,73	196	46,1	4,25	205	42,3	4,85	216	38,7	5,59
	25	93,5	24,7	3,78	97,4	22,6	4,30	102	20,7	4,90	107	18,9	5,63
	Minimum	73,9	19,4	3,81	76,8	17,7	4,33	79,9	16,2	4,93	83,7	14,8	5,65
170.5	100	432	158	2,74	453	143	3,16	474	130	3,64	500	119	4,22
	75	324	101	3,20	340	93,0	3,65	356	85,5	4,16	375	78,4	4,79
	50	216	59,3	3,65	226	54,7	4,14	237	50,3	4,72	250	46,0	5,44
	25	108	29,1	3,71	113	26,7	4,22	118	24,5	4,81	124	22,4	5,53
	Minimum	72,8	19,2	3,78	75,6	17,6	4,30	78,7	16,1	4,90	82,6	14,7	5,62
185.5	100	474	183	2,59	497	166	3,00	521	151	3,46	550	137	4,01
	75	355	116	3,08	373	106	3,51	391	97,4	4,01	413	89,3	4,62
	50	237	66,9	3,54	249	61,7	4,03	261	56,7	4,59	275	51,9	5,30
	25	118	32,7	3,63	123	30,0	4,10	129	27,5	4,68	136	25,1	5,40
	Minimum	73,1	19,6	3,74	75,1	17,9	4,20	78,3	16,3	4,80	82,3	14,9	5,54
210.6	100	527	202	2,62	552	183	3,02	578	166	3,48	610	151	4,03
	75	395	126	3,14	414	116	3,59	434	106	4,09	457	97,0	4,71
	50	264	71,4	3,69	276	65,9	4,19	289	60,7	4,77	305	55,5	5,50
	25	132	34,3	3,84	138	31,5	4,37	144	28,8	4,98	151	26,3	5,74
	Minimum	72,7	17,6	4,12	75,4	16,0	4,70	78,3	14,6	5,37	81,9	13,3	6,18
225.6	100	580	211	2,75	608	192	3,17	636	174	3,65	670	159	4,22
	75	435	134	3,24	456	123	3,70	477	113	4,22	502	103	4,86
	50	290	83,8	3,46	304	77,2	3,94	318	70,9	4,49	335	64,9	5,16
	25	145	39,6	3,66	151	36,4	4,16	158	33,3	4,74	166	30,5	5,45
	Minimum	72,8	17,7	4,12	75,5	16,1	4,70	78,4	14,6	5,37	82,1	13,3	6,18
240.6	100	623	236	2,64	649	214	3,03	678	195	3,48	722	177	4,07
	75	467	149	3,14	487	137	3,56	508	126	4,05	542	113	4,80
	50	312	87,1	3,58	325	80,3	4,04	339	73,7	4,60	361	67,0	5,39
	25	156	41,8	3,73	161	38,2	4,22	168	34,9	4,80	178	31,7	5,63
	Minimum	120	31,5	3,82	124	28,7	4,33	129	26,1	4,94	137	23,6	5,78

Load = % of cooling capacity compared to the value at full load

kWf = cooling capacity in kW

kWe_tot = unit total power input in kW

Internal exchanger water temperature = leaving 7°C / entering 12°C / variable flow-rate with external exchanger air temperature

ST - Standard acoustic configuration

The units is supplied with SCROLL compressors without soundproofing casing.

- ⚠ With the standard acoustic configuration if the hydronic units installed on the unit are selected, they are supplied without casing.

To find out the standard unit sound level, refer to the 'Sound levels' tables.



SC - Acoustic configuration with compressor soundproofing (standard)

Configuration used to increase the unit's silent operation by acting on the source of the noise. It consists of suitable steel casings lined with high-density material designed to provide sound insulation. The casings are secured to an aluminium frame and painted on the outside with polyester powder (RAL 9001).

- ⚠ With the acoustic configuration with compressor soundproofing if the hydronic units installed on the unit are selected, they are supplied without casing.

To assess the quality of the soundproofing benefit, refer to the 'Sound levels' tables.



EN - Super-silenced acoustic configuration

Configuration that further increases the unit's silent operation by acting on the source of the noise. It consists of suitable steel casings lined with high-density material designed to provide sound insulation. The casings are secured to an aluminium frame and painted on the outside with polyester powder (RAL 9001). The unit also reduces the air flow.

- ⚠ With the super-silenced acoustic configuration, if the hydronic units installed on the unit are selected, they are supplied with casing.

To assess the benefit of the super silenced configuration, refer to the "Sound levels" tables.



PPBM - Microchannel coils protection panels

Microchannel coils protection panels supplied on the manifold side.

They guarantee greater protection during transport and from accidental contact with things or people.



Standard unit



Unit with PPBM option

Configurations

PFGP - Soundproofing paneling of the pumping unit

Configuration used to increase the hydronic assembly's silent operation.

It is made up of steel casings lined internally with high-density material with a soundproofing function. The casings are pre-painted with RAL 9001 color.

Option available for all pumping groups installed on the unit, in combination with the standard acoustic configuration (ST) and with compressor soundproofing (SC)

B - Low water temperature (Brine)

Configuration also known as "Brine". Enables an "unfreezable" solution to be cooled (for example, water and ethylene glycol in suitable quantities) up to a temperature of between +4°C and -8°C. It includes:

- suitable exchangers with extra-thick closed-cell insulation
- electronic expansion valve, functional calibration and safety devices suitable for particular uses.

⚠ The unit in this configuration has a different operation range, indicated in the operating range section.

⚠ In low temperature operation, some staging steps could not be available.

⚠ The glycol concentration must be chosen based on the minimum temperature the water can reach. The presence of glycol influences pressure drops on the water side and the unit's output as indicated in the table reporting the "correction factors for use with glycol".

⚠ The "Extremely low water temperature" option for the chilled water production down to -12°C is available on request.

CCME - E-coated microchannel coil

The full aluminium microchannel coil is completely treated by electrolysis so as to create a protective layer of epoxy polymer on the surface, with the following characteristics:

- over 3000 hours of protection against salt spray (ASTM G85 A3 - SWAAT);
- over 2000 hours of protection against UV rays (ASTM G155-05a)
- provide a very high resistance against corrosion

Categories of atmospheric corrosion

Atmospheric corrosion is divided into six categories of corrosivity level, as shown in table.

Corrosivity	ISO 9223 Category	Corrosion rate for aluminium g/m ²
Very low	C1	negligible
Low	C2	$r_{corr} \leq 0.6$
Medium	C3	$0.6 < r_{corr} \leq 2$
High	C4	$2 < r_{corr} \leq 5$
Very high	C5	$5 < r_{corr} \leq 10$
Extreme	CX	$r_{corr} > 10$

Atmospheric Corrosivity category (ISO 9223)	C1, C2	C3 (inland)	C3 (coastal)	C4	C5	CX
Corrosivity	Very low, low	Medium	Medium	High	Very high	Extreme
Typical environments -examples	Indoor, Rural areas	Urban areas	Urban areas	Polluted Urban, industrial, coastal areas	Very high pollution & salt deposition areas	Extreme industrial, coastal areas
CCM - coils (standard)	OK	OK	NR	NR	NR	NR
CCME - E-coated microchannel coil	OK	OK	OK	OK	AP	AP

OK: Recommended;

AP: Acceptable, life may be shorter;

NR: Not recommended

D - Partial energy recovery

A configuration which enables the production of hot water free-of-charge while operating in the cooling mode, thanks to the partial recovery of condensation heat that would otherwise be disposed of into the external heat source.

This option is also known as “desuperheater”. It is made up of a Inox 316 stainless steel brazed plate heat exchangers, suitable for recovering a part of the capacity dispersed by the unit (the dispersed heating capacity is equal to the sum of the cooling capacity and the electrical input capacity of the compressors). The partial recovery device is considered to be operating when it is powered by the water flow which is to be heated. This condition improves the unit performance, since it reduces the condensation temperature: in nominal conditions the cooling capacity increases indicatively by 3.2% and the power input of the compressors is reduced by 3.6%.

When the temperature of the water to be heated is particularly low, it is opportune to insert a flow regulation valve in the hydraulic circuit, to maintain the recovery output temperature at higher than 35°C and thus avoid refrigerant condensation in the partial energy recovery device.

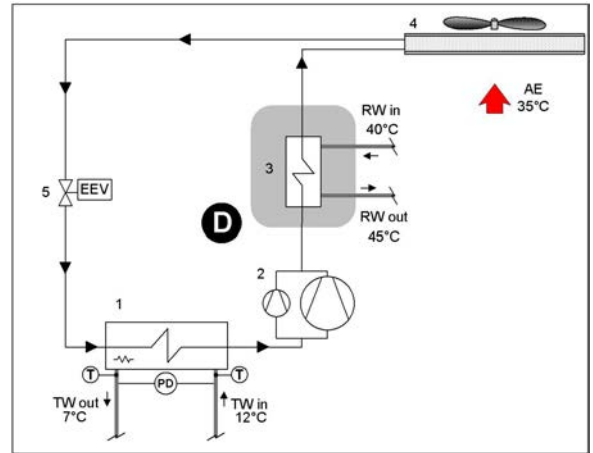

D - Partial recovery device

- 1 - Internal exchanger
- 2 - Compressors
- 3 - Recovery exchanger
- 4 - External exchanger
- 5 - Expansion electronic valve

- TW in chilled water inlet
- TW out chilled water outlet
- RW in - Recovery water input
- RW out - Recovery water output
- T - Temperature probe
- PD - Differential pressure switch
- AE Outdoor air

Partial recovery heating capacity

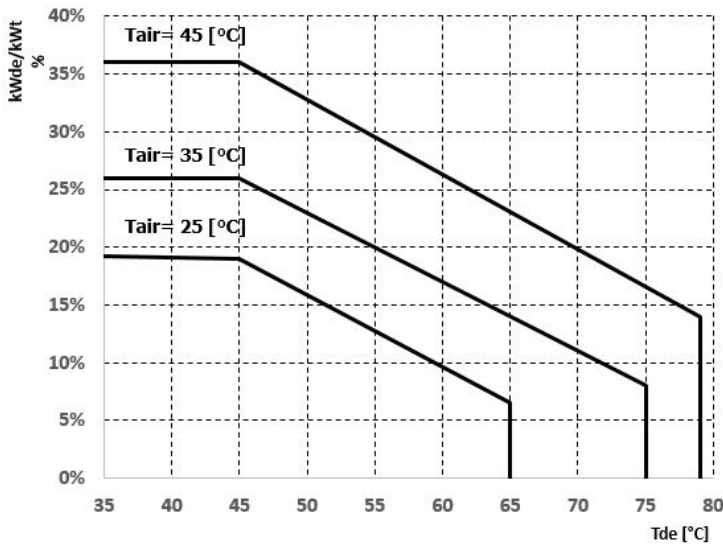

$kWde/kWt$ = Heat recovered / Condenser heating capacity (cooling capacity + compressor power input) [%]

Tde = Heat recovering device outlet water temperature [°C]

⚠ Values with a tolerance of ± 2%

Configurations

Pressure drops of partial energy recovery exchanger

Excellence

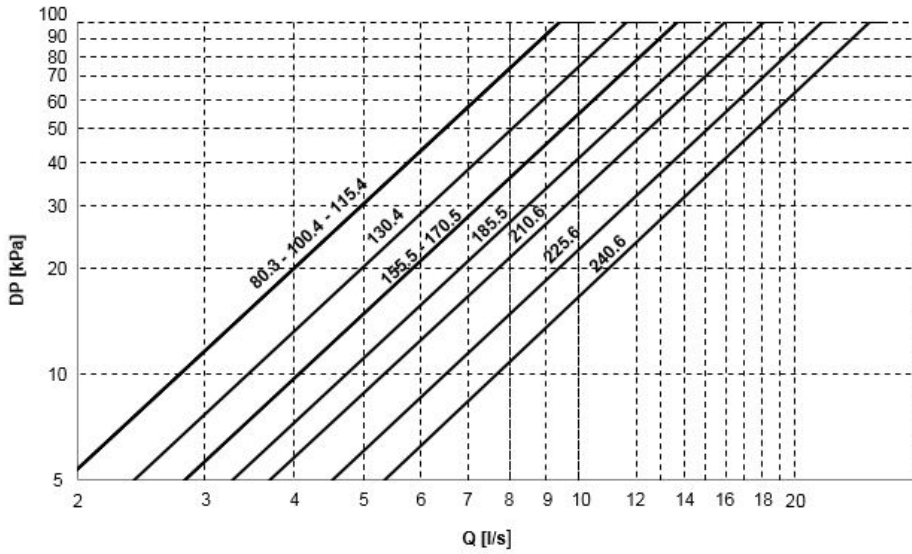

Admissible water flow-rates

Minimum (Qmin) and maximum (Qmax) admissible water flow for the unit to operate correctly

SIZE		80.3	100.4	115.4	130.4	155.5	170.5	185.5	210.6	225.6	240.6
Qmin	[l/s]	1,9	1,9	1,9	2,4	2,8	2,8	3,3	3,7	4,5	5,3
Qmax	[l/s]	9,4	9,4	9,4	11,6	13,8	13,8	16,0	18,1	21,8	25,4

Premium

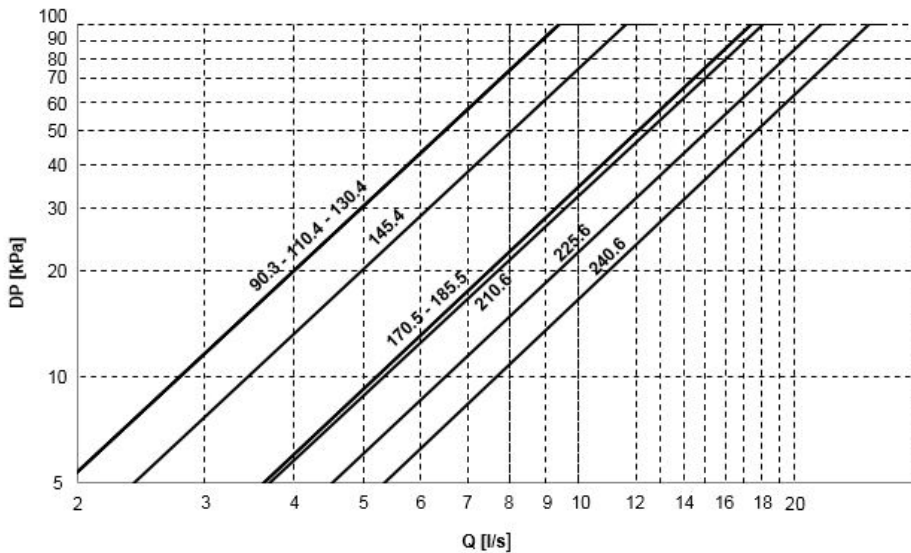

Admissible water flow-rates

Minimum (Qmin) and maximum (Qmax) admissible water flow for the unit to operate correctly

SIZE		90.3	110.4	130.4	145.4	170.5	185.5	210.6	225.6	240.6
Qmin	[l/s]	1,9	1,9	1,9	2,4	3,6	3,6	3,7	4,5	5,3
Qmax	[l/s]	9,4	9,4	9,4	11,6	17,4	17,4	18,1	21,8	25,4

R - Total energy recovery

A configuration which enables the production of hot water free-of-charge while operating in the cooling mode, thanks to the total recovery of condensation heat that would otherwise be disposed of into the external heat source. This solution increases the overall efficiency of the system in all cases where a high-level of hot water production is required. It is made up of a brazed plate heat exchanger made of 316 stainless steel, suitable for recovering all the unit heat capacity (equal to the sum of the cooling capacity and the electrical input capacity of the compressors), from the on-off type solenoid valve, from the supply and return temperature sensors in the hot water circuit and the related two-step integrated control logic.

Hot water availability is always subordinate to the production of chilled water.

See the following example:

- cooling capacity request = 100% / Heating capacity request = 0% > Production only of cooling capacity;
- cooling capacity request = 100% / Heating capacity request = 0% > Production of cooling and heating capacity by recovery;
- cooling capacity request = 50% / Heating capacity request = 100% > Production of cooling and heating capacity by recovery, equal to the 50% of the requested heating capacity.

⚠ To prevent constant switching in the unit's refrigeration circuit, it is necessary to install a storage tank with an adequate capacity in the system's hot water circuit.

⚠ In the absence of hot water circulation in the recovery exchanger, the maximum inlet air temperature is reduced by approximately 2°C compared with the unit without "Total Energy Recovery" mode.

TOTAL OPERATING ENERGY RECOVERY

When hot water is requested, the condensing coil is deactivated. Condensation takes place wholly within the recovery circuit.

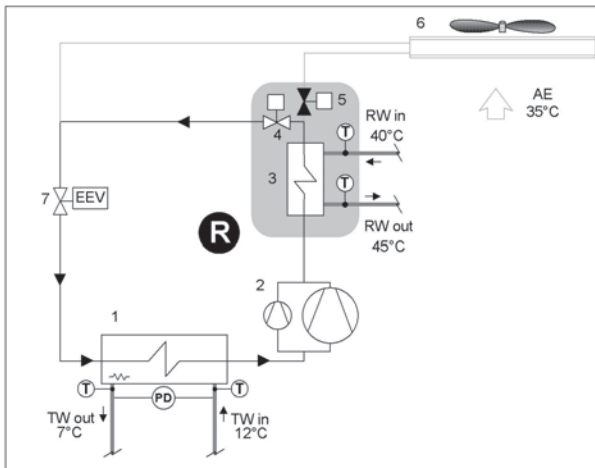

TOTAL NON-OPERATING ENERGY RECOVERY

When the recovery set-point has been satisfied, the condensing coil is reactivated. In this condition, the total recovery circuit operates as a Partial recovery circuit (Desuperheater).

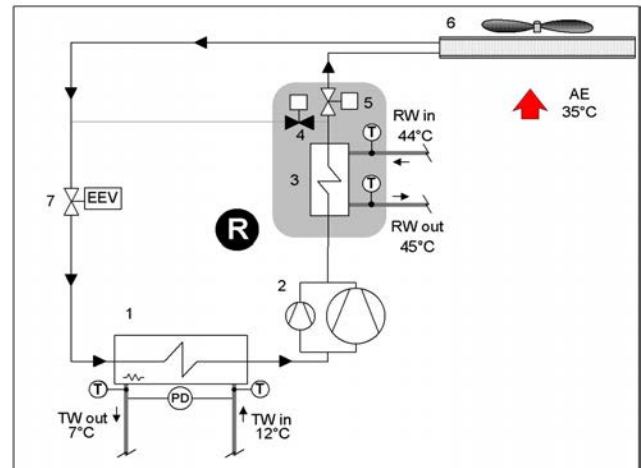

- R - Total recovery device
- 1 - Internal exchanger
- 2 - Compressors
- 3 - Recovery exchanger
- 4 - Total recovery enabling valve

- 5 - External exchanger enabling valve
- 6 - External exchanger
- 7 - Expansion electronic valve
- T - Temperature probe
- PD - Differential pressure switch

- TW in - Chilled water inlet
- TW out - Chilled water outlet
- RW in - Recovery water input
- RW out - Recovery water output
- AE Outdoor air

Total energy recovery operating range

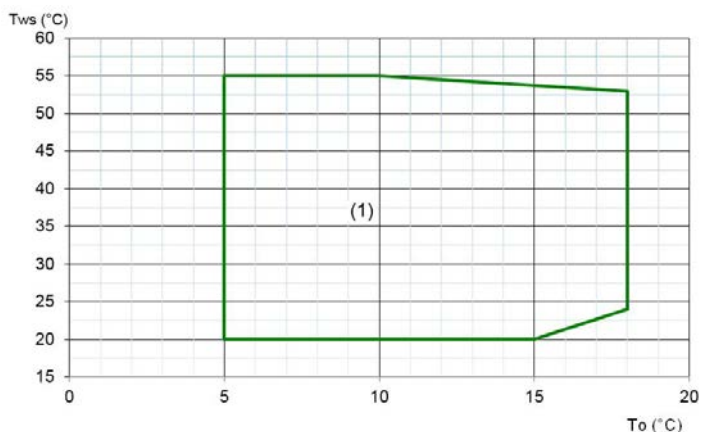

1. Standard unit operating range at full load

Configurations

Pressure drops of the total energy recovery exchanger

Excellence

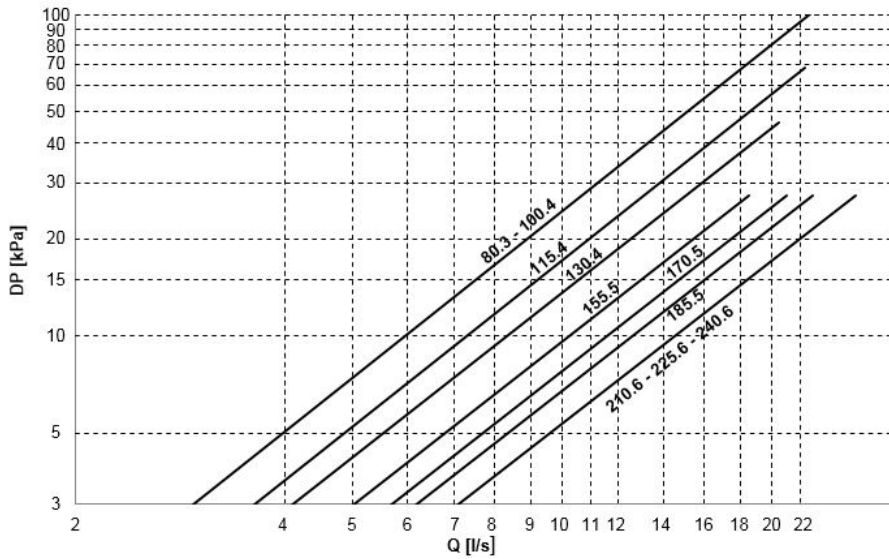

Q = Water flow-rate[l/s]
DP = Water side pressure drops [kPa]

Admissible water flow-rates

Minimum (Qmin) and maximum (Qmax) admissible water flow for the unit to operate correctly

SIZE		80.3	100.4	115.4	130.4	155.5	170.5	185.5	210.6	225.6	240.6
Qmin	[l/s]	2,7	2,7	3,3	3,7	4,5	5,1	5,6	6,4	6,4	6,4
Qmax	[l/s]	26,4	26,4	22,3	20,4	18,5	21,0	22,9	26,4	26,4	26,4

Premium

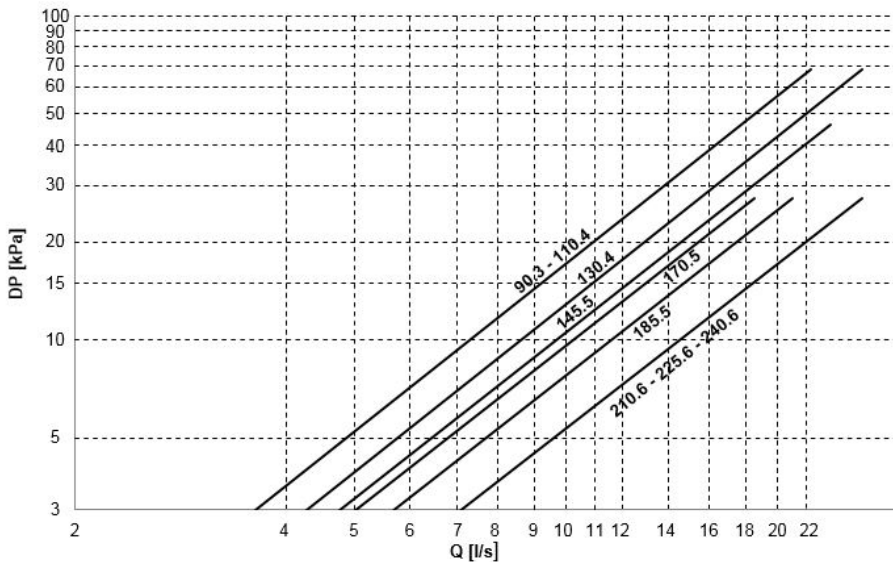

Q = Water flow-rate[l/s]
DP = Water side pressure drops [kPa]

Admissible water flow-rates

Minimum (Qmin) and maximum (Qmax) admissible water flow for the unit to operate correctly

SIZE		90.3	110.4	130.4	145.4	170.5	185.5	210.6	225.6	240.6
Qmin	[l/s]	3,3	3,3	3,9	4,3	4,5	5,1	6,4	6,4	6,4
Qmax	[l/s]	22,3	22,3	26,4	23,7	18,5	21,0	26,4	26,4	26,4

EVFTP - Shell and tube exchanger PED test

Direct expansion exchanger with two independent circuit refrigerant side. The exchanger is composed of a cover made of carbon steel. The tubes, anchored to the tube plate by mechanical expansion, are made of copper, high efficiency, internally rifled to improve thermal exchange and specially designed for use with modern ecological refrigerants. It also includes a water side protection differential switch, an anti-freeze heating element to protect against icing, and covering in closed-cell thermo-insulating material that prevents the formation of condensation and heat exchange with the exterior. The water connections of the exchanger are quick-release with splined joint (Victaulic).

Shell and tube exchanger pressure drops (EVFTP) - Excellence

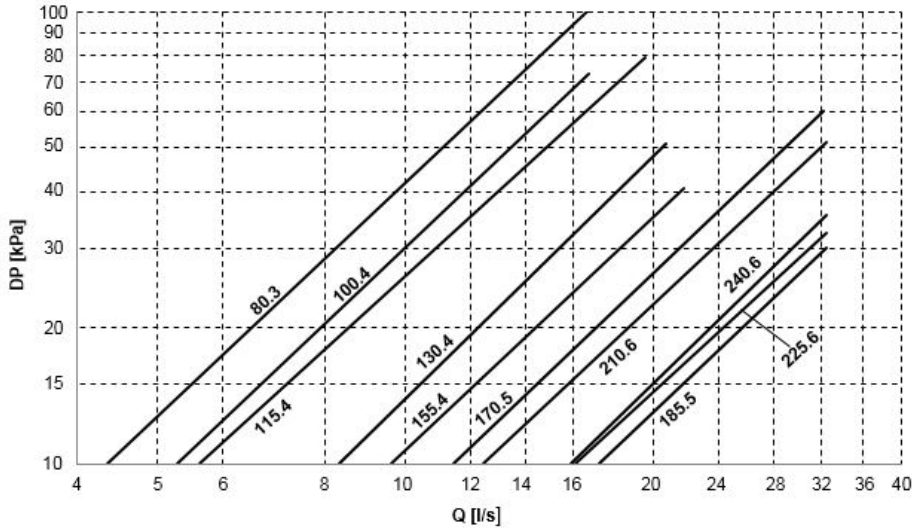

The pressure drops are calculated considering a water temperature of 7°C

Q = Water flow-rate[l/s]
DP = Water side pressure drops [kPa]

The water flow-rate must be calculated with the following formula

$$Q [l/s] = kWf / (4,186 \times DT)$$

kWf = Cooling capacity in kW
DT = Temperature difference between inlet / outlet water

Admissible water flow-rates

Minimum (Qmin) and maximum (Qmax) admissible water flow for the unit to operate correctly

SIZE		80.3	100.4	115.4	130.4	155.5	170.5	185.5	210.6	225.6	240.6
Qmin	[l/s]	4,4	5,3	5,6	8,3	9,6	11,5	17,2	12,5	16,1	15,9
Qmax	[l/s]	16,6	16,7	19,6	20,7	21,8	32,3	32,4	32,4	32,4	32,4

Shell and tube exchanger pressure drops (EVFTP) - Premium

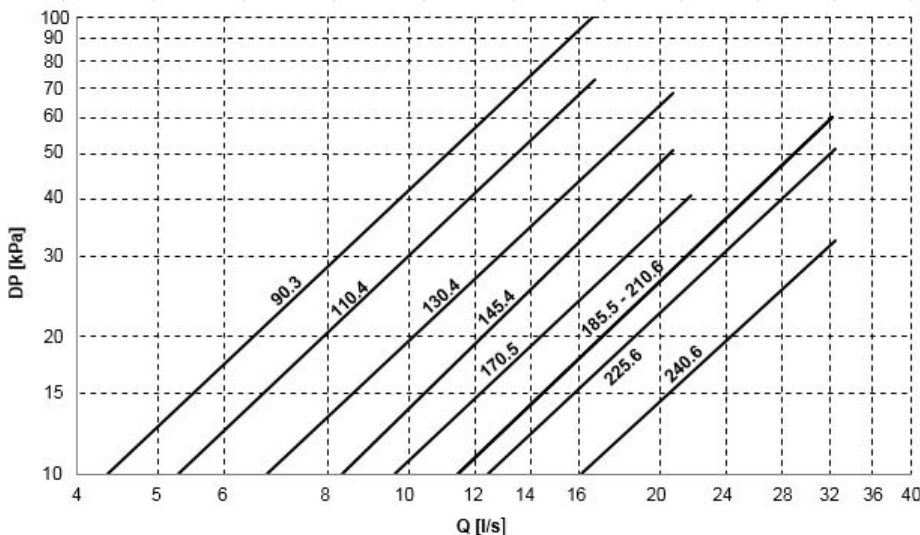

The pressure drops are calculated considering a water temperature of 7°C

Q = Water flow-rate[l/s]
DP = Water side pressure drops [kPa]

The water flow-rate must be calculated with the following formula

$$Q [l/s] = kWf / (4,186 \times DT)$$

kWf = Cooling capacity in kW
DT = Temperature difference between inlet / outlet water

Admissible water flow-rates

Minimum (Qmin) and maximum (Qmax) admissible water flow for the unit to operate correctly

SIZE		90.3	110.4	130.4	145.4	170.5	185.5	210.6	225.6	240.6
Qmin	[l/s]	4,4	5,3	6,8	8,3	9,6	11,5	11,5	12,5	16,1
Qmax	[l/s]	16,6	16,7	20,7	20,7	21,8	32,3	32,3	32,4	32,4

Accessories - Hydronic assembly

1PM/1PMH - User side HydroPack with N° 1 pump

Option supplied built-in the unit. Pumping unit made up of N°1 centrifugal electric pump, with the pump body made of cast iron and the impeller made of INOX or cast iron (depending on the models).

Mechanical seal using ceramic, carbon and EPDM elastomer components.

Three-phase electric motor with IP55 degree of protection. Complete with a thermoformed insulating casing, quick connections with insulated casing, safety valve, pressure gauges, system safety pressure switch, stainless steel antifreeze, intake, immersion-type heaters.

All water fittings are Victaulic.

1PM = Hydropack with N° 1 pump

1PMH = Hydropack with N° 1 high static pressure pump

CONNECTION DIAGRAM - GROUP WITH N° 1 PUMP

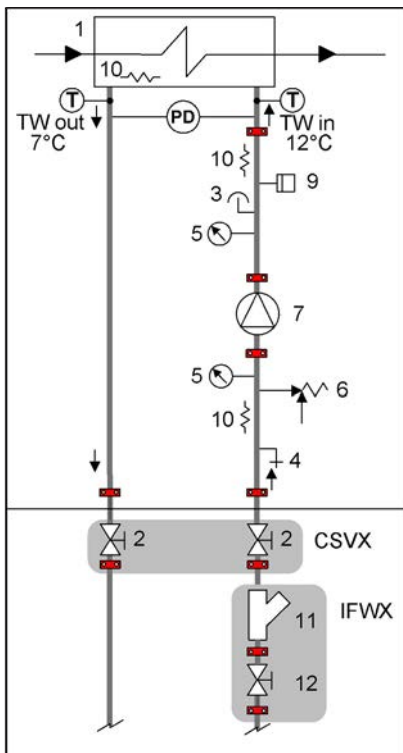

- 1 - Internal exchanger
- 2 - Cutoff valve - (CSVX Couple of manually operated shut-off valves)
- 3 - Purge valve
- 4 - Discharge stop valve
- 5 - Pressure gauge
- 6 - Safety valve (6 Bar)
- 7 - Packaged electric pump with high efficiency impeller
- 9 - System load safety pressure switch (it avoids the pump operation if water is not present)
- 10 - Antifreeze heater
- 11 - Steel mesh strainer water side (IFWX)
- 12 - Cutoff valve with quick joints

T - Temperature probe
PD - Differential pressure switch

TW in chilled water inlet
TW out chilled water outlet

The grey area indicates further optional components.

- ⚠ Provide hydraulic interceptions outside the unit ('CSVX - Couple of manually operated shut-off valves' option) to facilitate any possible extraordinary maintenance interventions.
- ⚠ It is necessary to provide a non-return valve for each unit installed in hydraulic parallel and equipped with an hydronic assembly installed on board (Installation by the Customer).

Electrical data Hydropack

PUMP	Rated power [kW]	Nominal Current [A]
1PM 80.3 - 100.4 EXC / 90.3 PRM	3	6,35
1PM 115.4 EXC / 110.4 - 130.4 PRM	4	7,8
1PM 130.4 ÷ 185.5 EXC / 145.4 ÷ 185.5 PRM	5,5	10,6
1PM 210.6 ÷ 240.6 EXC / PRM	7,5	14,4

PUMP	Rated power [kW]	Nominal Current [A]
1PMH 80.3 ÷ 115.4 EXC / 90.3 ÷ 130.4 PRM	7,5	14,4
1PMH 130.4 ÷ 185.5 EXC / 145.4 ÷ 185.5 PRM	11	20,6
1PMH 210.6 ÷ 240.6 EXC / PRM	15	27,5

1PM - HYDROPACK WITH N° 1 PUMP

Head

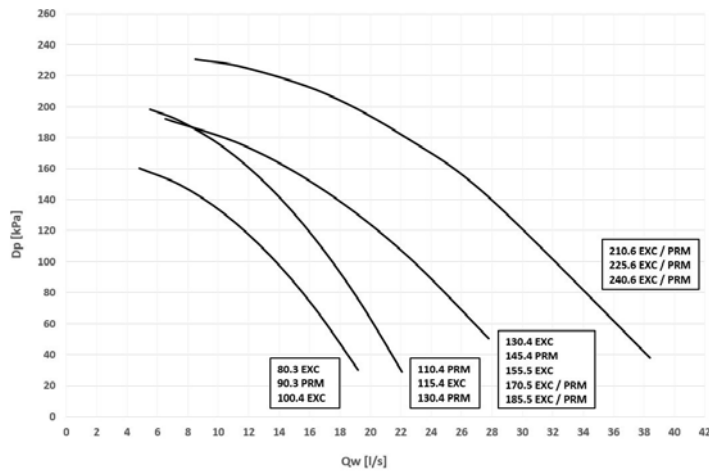

Dp = Pump head [kPa]
QW = Water flow-rate [l/s]

Power input

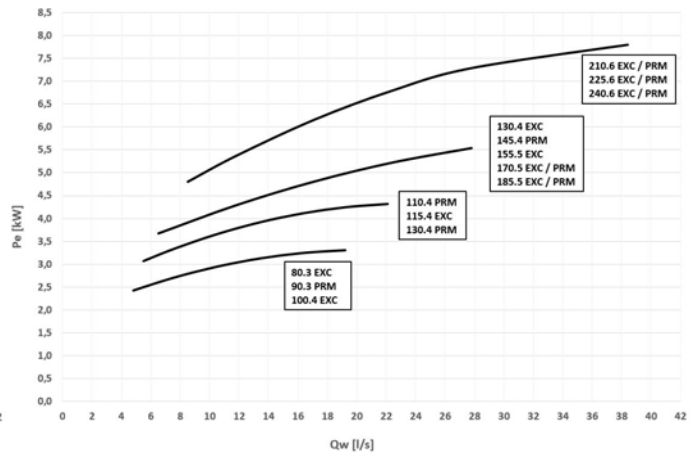

Pe = Power input [kW]
QW = Water flow-rate [l/s]

1PMH - HYDROPACK WITH NR.1 HIGH STATIC PRESSURE PUMP

Head

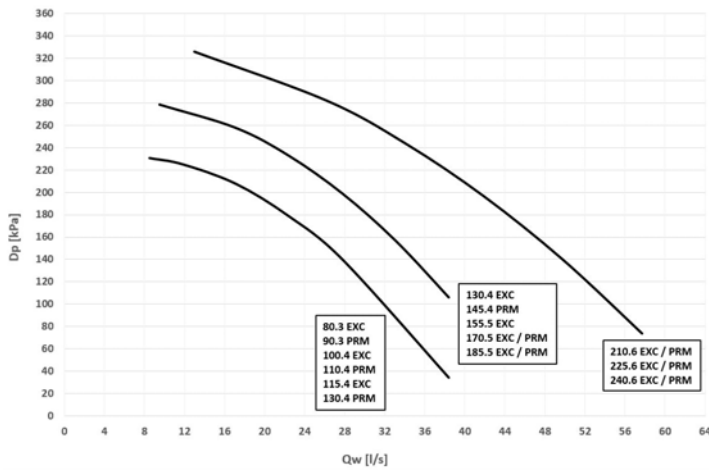

Dp = Pump head [kPa]
QW = Water flow-rate [l/s]

Power input

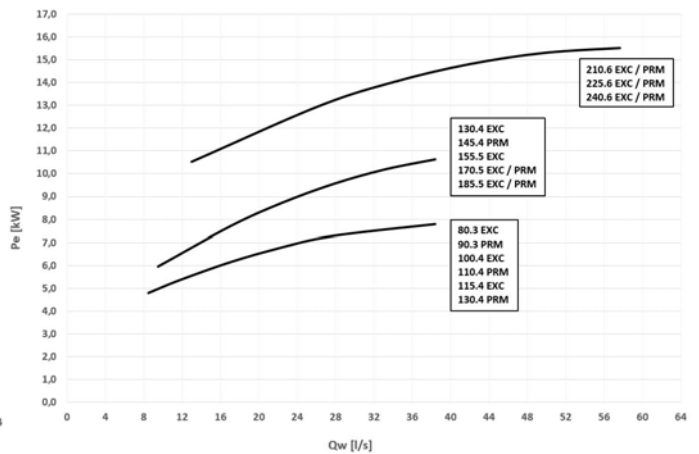

Pe = Power input [kW]
QW = Water flow-rate [l/s]

⚠ Caution: to obtain the available pressure values, you need to subtract the following from the head values represented in these diagrams:
Internal exchanger pressure drop
IFVX accessory –Steel mesh filter on the water side (where applicable)

Accessories - Hydronic assembly

1PMV/1PMVH - Hydropack user side with N° 1 inverter pump

Option supplied on the unit. Pumping unit made up of one electropump controlled by inverter to adapt to the different application conditions. It enables the automatic reduction of the liquid flow rate in critical conditions, avoiding blocks due to overloading and consequential intervention work by specialised technical personnel.

Through the inverter calibration, standard supplied, it is possible to adapt the pump flow-rate/head to the installation feature.

Centrifugal electric pump with the pump body made of cast iron and the impeller made of AISI 316 stainless steel (depending on the models).

Mechanical seal using ceramic, carbon and EPDM elastomer components

Three-phase electric motor with IP55-protection. Complete with thermoformed insulated casing, fast fittings with insulated casing, safety valve, pressure gauges, system load safety pressure switch, stainless steel anti-freeze immersion resistances located at the intake and at the supply point.

In combination with the "IVFDT" - Variable flow-rate control option, it allows the water flow rate variation to the installation in part load operation to obtain the maximum unit efficiency and lower pumping unit consumption.

All water fittings are Victaulic.

1PMV = Hydropack with N° 1 inverter pump

1PMVH = Hydropack with N° 1 high static pressure inverter pump

CONNECTION DIAGRAM - GROUP WITH N° 1 INVERTER PUMP

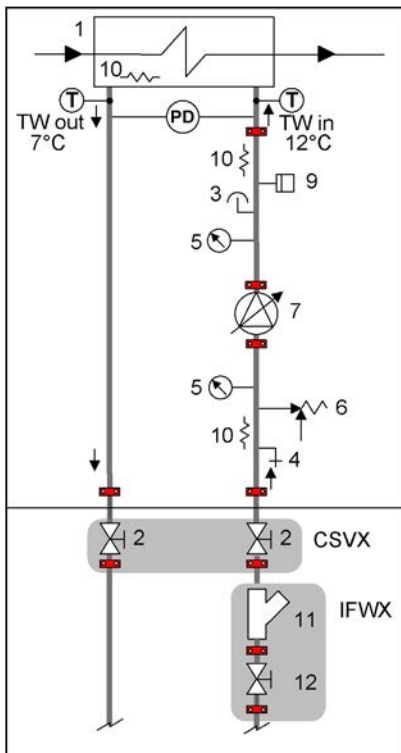

- 1 - Internal exchanger
- 2 - Cutoff valve - (CSVX Couple of manually operated shut-off valves)
- 3 - Purge valve
- 4 - Discharge stop valve
- 5 - Pressure gauge
- 6 - Safety valve (6 Bar)
- 7 - Packaged electric pump with high efficiency impeller
- 9 - System load safety pressure switch (it avoids the pump operation if water is not present)
- 10 - Antifreeze heater
- 11 - Steel mesh strainer water side (IFWX)
- 12 - Cutoff valve with quick joints

T - Temperature probe
PD - Differential pressure switch

TW in chilled water inlet
TW out chilled water outlet

The grey area indicates further optional components.

- ⚠ Provide hydraulic interceptions outside the unit ('CSVX - Couple of manually operated shut-off valves' option) to facilitate any possible extraordinary maintenance interventions.
- ⚠ It is necessary to provide a non-return valve for each unit installed in hydraulic parallel and equipped with an hydronic assembly installed on board (Installation by the Customer).

Electrical data Hydropack

PUMP	Rated power [kW]	Nominal Current [A]
1PMV 80.3 - 100.4 EXC / 90.3 PRM	3	6,35
1PMV 115.4 EXC / 110.4 - 130.4 PRM	4	7,8
1PMV 130.4 ÷ 185.5 EXC / 145.4 ÷ 185.5 PRM	5,5	10,6
1PMV 210.6 ÷ 240.6 EXC / PRM	7,5	14,4

PUMP	Rated power [kW]	Nominal Current [A]
1PMVH 80.3 ÷ 115.4 EXC / 90.3 ÷ 130.4 PRM	7,5	14,4
1PMVH 130.4 ÷ 185.5 EXC / 145.4 ÷ 185.5 PRM	11	20,6
1PMVH 210.6 ÷ 240.6 EXC / PRM	15	27,5

1PMV - HYDROPACK WITH N° 1 INVERTER PUMP

Head - Size 80.3 - 100.4 EXC / 90.3 PRM

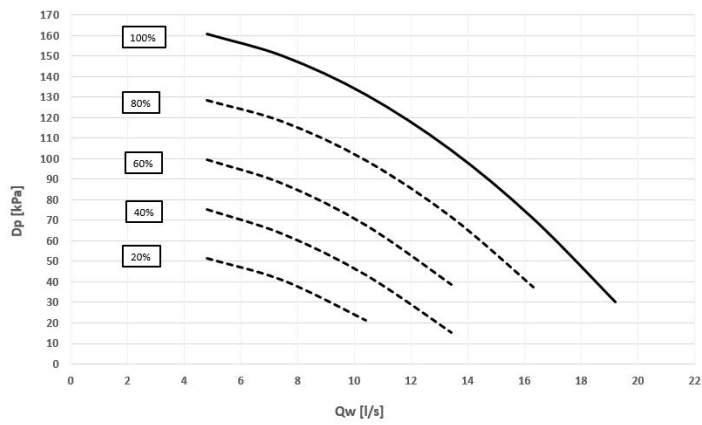

Dp = Pump head [kPa]
QW = Water flow-rate [l/s]

Power input - Size 80.3 - 100.4 EXC / 90.3 PRM

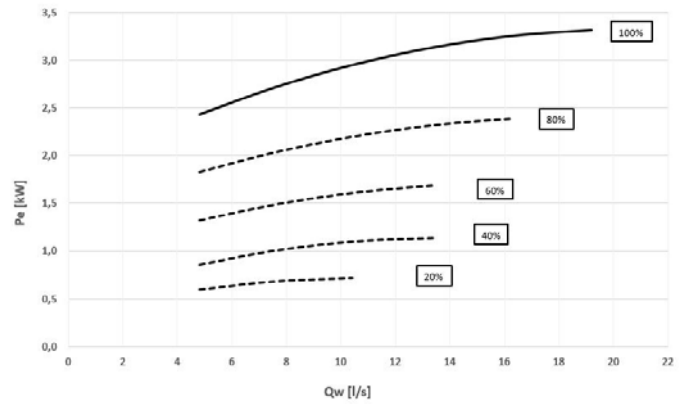

Pe = Power input [kW]
QW = Water flow-rate [l/s]

Head - Size 115.4 EXC / 110.4 - 130.4 PRM

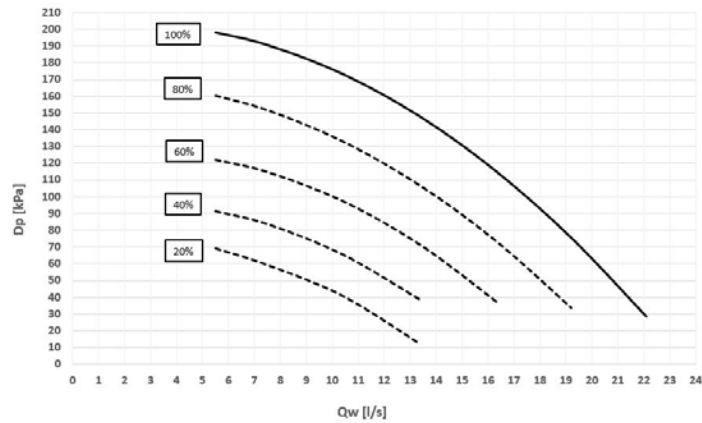

Dp = Pump head [kPa]
QW = Water flow-rate [l/s]

Power input - Size 115.4 EXC / 110.4 - 130.4 PRM

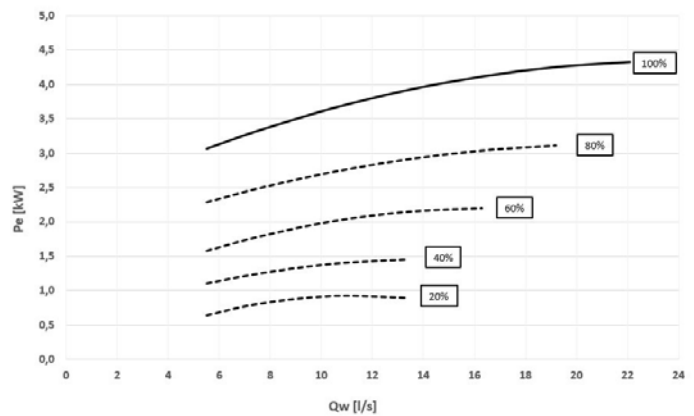

Pe = Power input [kW]
QW = Water flow-rate [l/s]

Head - Size 130.4 ÷ 185.5 EXC / 145.4 ÷ 185.5 PRM

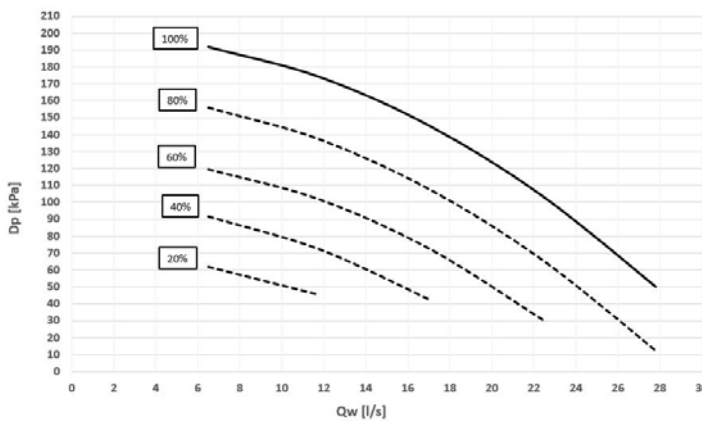

Dp = Pump head [kPa]
QW = Water flow-rate [l/s]

Power input - Size 130.4 ÷ 185.5 EXC / 145.4 ÷ 185.5 PRM

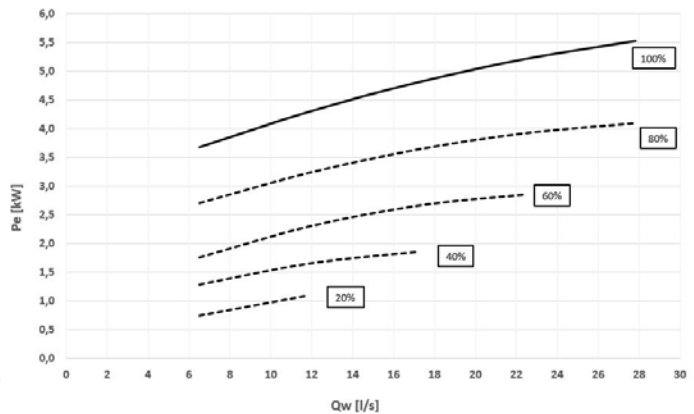

Pe = Power input [kW]
QW = Water flow-rate [l/s]

Accessories - Hydronic assembly

1PMV - HYDROPACK CON N° 1 POMPA AD INVERTER

Head - Size 210.6 ÷ 240.6 EXC / PRM

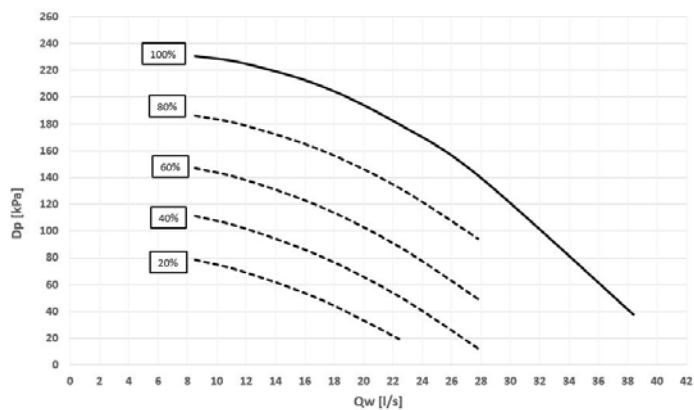

Power input - Size 210.6 ÷ 240.6 EXC / PRM

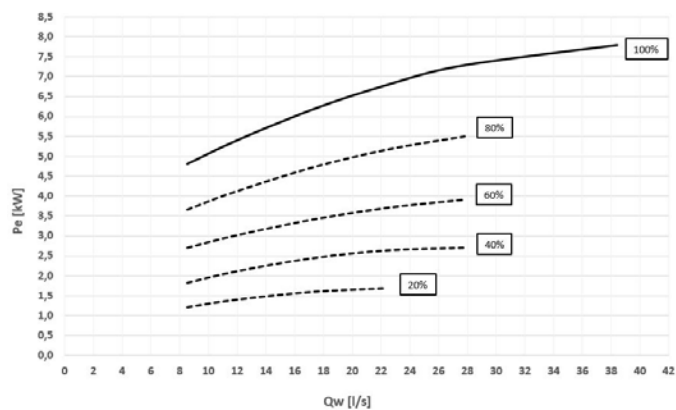

Dp = Pump head [kPa]
Qw = Water flow-rate [l/s]

Pe = Power input [kW]
Qw = Water flow-rate [l/s]

⚠ Caution: to obtain the available pressure values, you need to subtract the following from the head values represented in these diagrams:
Internal exchanger pressure drop
IFVX accessory –Steel mesh filter on the water side (where applicable)

1PMVH - HYDROPACK CON N° 1 POMPA AD INVERTER ALTA PREVALENZA

Head - Size 80.3 ÷ 115.4 EXC / 90.3 ÷ 130.4 PRM

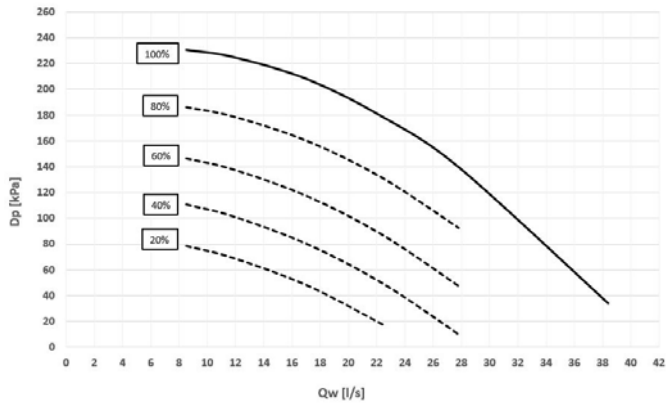

Dp = Pump head [kPa]
QW = Water flow-rate [l/s]

Power input - Size Gr. 80.3 ÷ 115.4 EXC / 90.3 ÷ 130.4 PRM

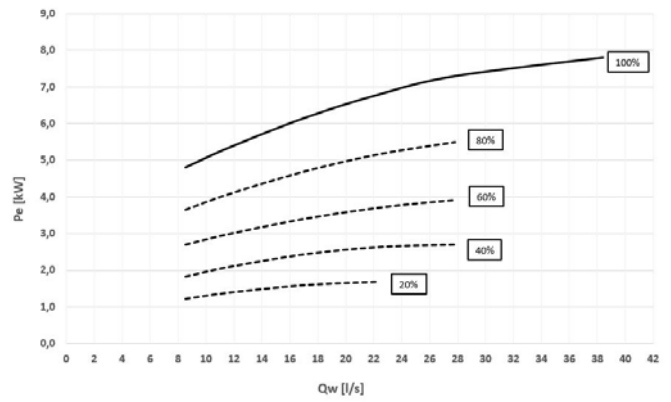

Pe = Power input [kW]
QW = Water flow-rate [l/s]

Head - Size 130.4 ÷ 185.5 EXC / 145.4 ÷ 185.5 PRM

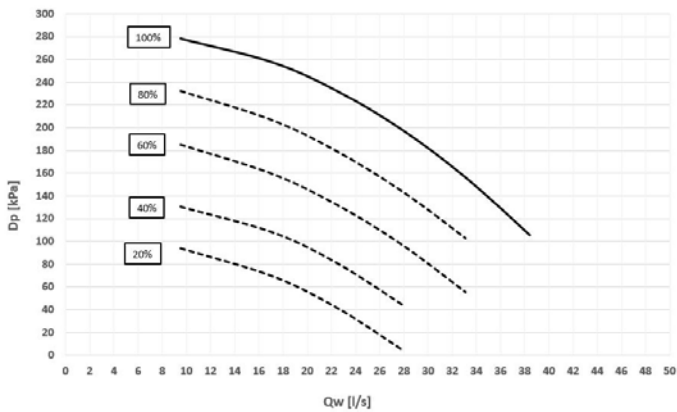

Dp = Pump head [kPa]
QW = Water flow-rate [l/s]

Power input - Size Gr. 130.4 ÷ 185.5 EXC / 145.4 ÷ 185.5 PRM

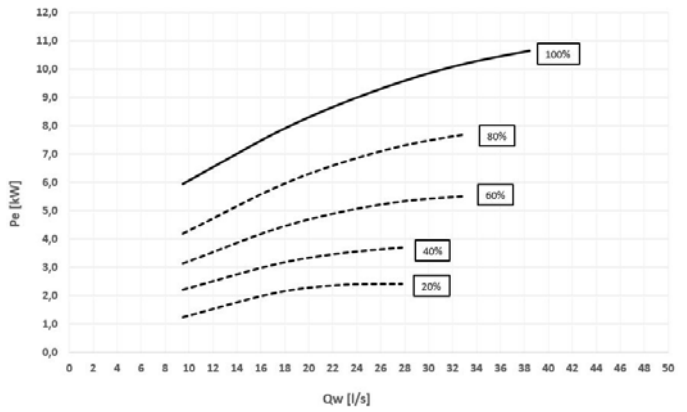

Pe = Power input [kW]
QW = Water flow-rate [l/s]

Head - Size 210.6 ÷ 240.6 EXC / PRM

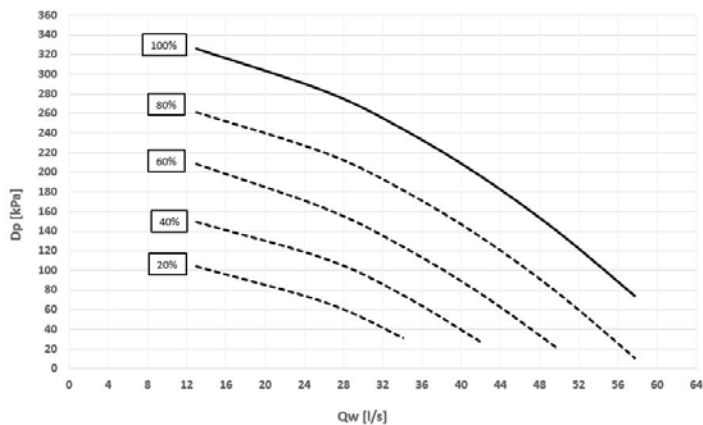

Dp = Pump head [kPa]
QW = Water flow-rate [l/s]

Power input - Size 210.6 ÷ 240.6 EXC / PRM

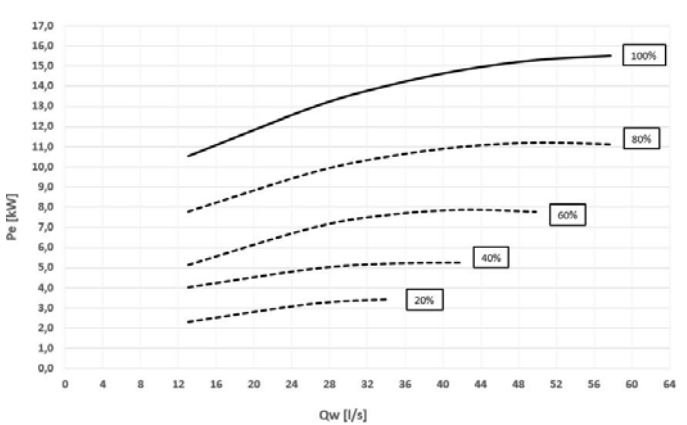

Pe = Power input [kW]
QW = Water flow-rate [l/s]

⚠ Caution: to obtain the available pressure values, you need to subtract the following from the head values represented in these diagrams:
Internal exchanger pressure drop
IFVX accessory –Steel mesh filter on the water side (where applicable)

Accessories - Hydronic assembly

2PM/2PMH - HydroPack with N° 2 pumps

Option supplied built-in the unit. Pumping unit made up of two electric pumps laid out in parallel, with auto-adaptive modular logic activation. It enables the automatic reduction of the liquid flow-rate in critical conditions, avoiding blocks due to overloading and consequential intervention work by specialised technical personnel.

Centrifugal electric pump, with the pump body made of cast iron and the impeller made of AISI 316 stainless steel.

Mechanical seal using ceramic, carbon and EPDM elastomer components.

Three-phase electric motor with IP55 degree of protection. Complete with a thermoformed insulating casing, quick connections with insulated casing, safety valve, pressure gauges, system safety pressure switch, stainless steel antifreeze, intake, immersion-type heaters.

All water fittings are Victaulic.

2PM = HydroPack with N° 2 pump

2PMH = HydroPack with N° 2 high static pressure pump

CONNECTION DIAGRAM - GROUP WITH N° 2 PUMPS

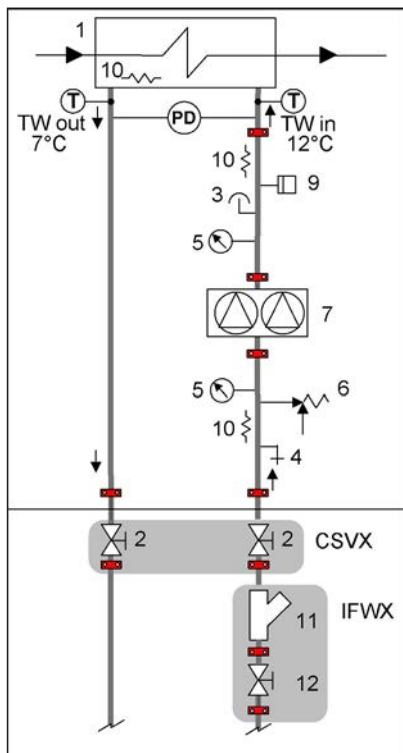

- 1 - Internal exchanger
- 2 - Cutoff valve - (CSVX Couple of manually operated shut-off valves)
- 3 - Purge valve
- 4 - Discharge stop valve
- 5 - Pressure gauge
- 6 - Safety valve (6 Bar)
- 7 - Packaged electric pump with high efficiency impeller
- 9 - System load safety pressure switch (it avoids the pump operation if water is not present)
- 10 - Antifreeze heater
- 11 - Steel mesh strainer water side (IFWX)
- 12 - Cutoff valve with quick joints

T - Temperature probe
PD - Differential pressure switch

TW in chilled water inlet
TW out chilled water outlet

The grey area indicates further optional components.

- ⚠ Provide hydraulic interceptions outside the unit ('CSVX - Couple of manually operated shut-off valves' option) to facilitate any possible extraordinary maintenance interventions.
- ⚠ It is necessary to provide a non-return valve for each unit installed in hydraulic parallel and equipped with an hydronic assembly installed on board (Installation by the Customer).

Electrical data HydroPack

PUMP	Rated power [kW]	Nominal Current [A]
2PM 80.3 - 100.4 EXC / 90.3 - 110.4 PRM	2 x 2,2	2 x 4,56
2PM 115.4 ÷ 185.5 EXC / 130.4 ÷ 210.6 PRM	2 x 4	2 x 7,62
2PM 210.6 ÷ 240.6 EXC / 225.6 - 240.6 PRM	2 x 5,5	2 x 10,5

PUMP	Rated power [kW]	Nominal Current [A]
2PMH 80.3 - 100.4 EXC / 90.3 - 110.4 PRM	2 x 4	2 x 7,62
2PMH 115.4 - 130.4 EXC / 130.4 - 145.4 PRM	2 x 5,5	2 x 10,5
2PMH 155.5 ÷ 210.6 EXC / 170.5 - 185.5 PRM	2 x 7,5	2 x 14,1
2PMH 225.6 - 240.6 EXC / 210.6 ÷ 240.6 PRM	2 x 11	2 x 20,2

2PM- HYDROPACK WITH N° 2 PUMPS

Head

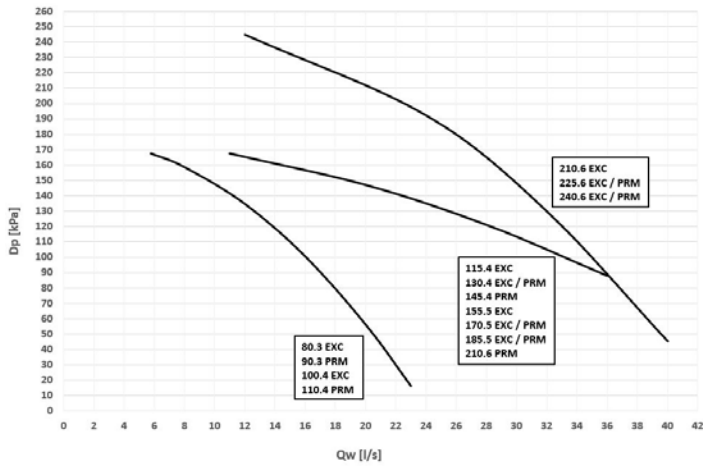

Dp = Pump head [kPa]
QW = Water flow-rate [l/s]

Power input

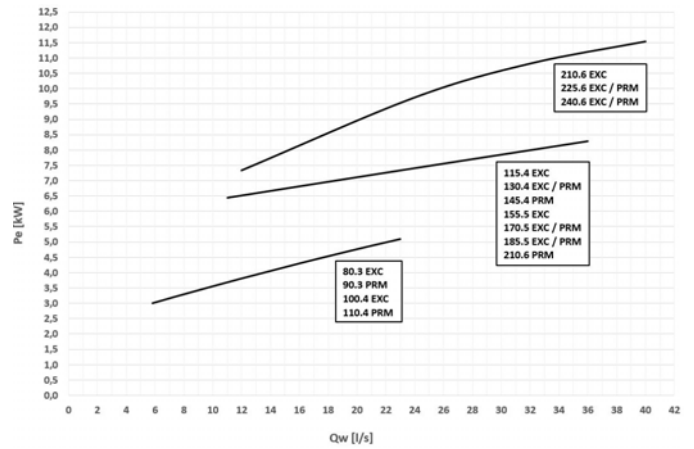

Pe = Power input [kW]
QW = Water flow-rate [l/s]

2PMH - HYDROPACK CON N° 2 POMPE ALTA PREVALENZA

Head

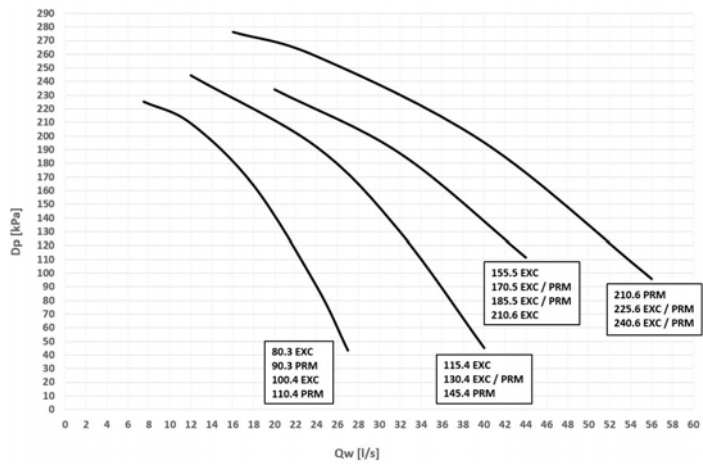

Dp = Pump head [kPa]
QW = Water flow-rate [l/s]

Power input

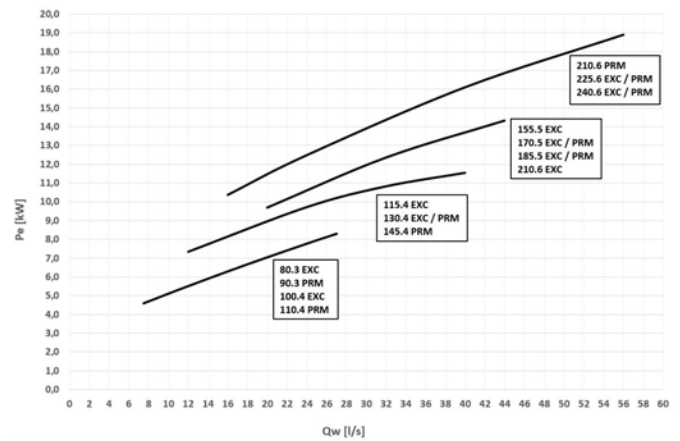

Pe = Power input [kW]
QW = Water flow-rate [l/s]

⚠ Caution: to obtain the available pressure values, you need to subtract the following from the head values represented in these diagrams:
Internal exchanger pressure drop
IFVX accessory –Steel mesh filter on the water side (where applicable)

Accessories - Hydronic assembly

2PMV/2PMVH - Hydropack user side with no. 2 of inverter pumps

Option supplied on the unit. Pumping unit consisting of parallel electric pumps and controlled by inverter to adapt to the different application conditions.

It enables the automatic reduction of the liquid flow-rate in critical conditions, avoiding blocks due to overloading and consequential intervention work by specialised technical personnel.

Through the inverter calibration, standard supplied, it is possible to adapt the pump flow-rate/head to the installation feature.

Centrifugal electric pump with impeller made with AISI 304 steel and AISI 304 stainless steel body or grey cast iron (depending on models).

Mechanical seal using ceramic, carbon and EPDM elastomer components.

Three-phase electric motor with IP44-protection. Complete with thermoformed insulated casing, quick connections with insulated casing, safety valve, pressure gauges, system load safety pressure switch, stainless steel antifreeze immersion heaters located at the return and supply point. In combination with the "IVFDT" - Variable flow-rate control option, it allows the water flow-rate variation to the installation in part load operation to obtain the maximum unit efficiency and lower pumping unit consumption.

All water fittings are Victaulic.

2PMV = Hydropack with N° 2 inverter pump

2PMVH = Hydropack with N° 2 high static pressure inverter pump

CONNECTION DIAGRAM - GROUP WITH 2 INVERTER PUMPS

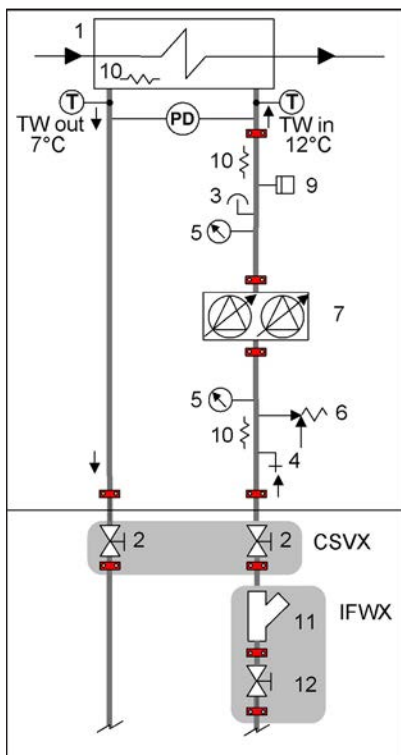

- 1 - Internal exchanger
- 2 - Cutoff valve - (CSVX Couple of manually operated shut-off valves)
- 3 - Purge valve
- 4 - Discharge stop valve
- 5 - Pressure gauge
- 6 - Safety valve (6 Bar)
- 7 - Packaged electric pump with high efficiency impeller
- 9 - System load safety pressure switch (it avoids the pump operation if water is not present)
- 10 - Antifreeze heater
- 11 - Steel mesh strainer water side (IFWX)
- 12 - Cutoff valve with quick joints

T - Temperature probe
PD - Differential pressure switch

TW in chilled water inlet
TW out chilled water outlet

The grey area indicates further optional components.

- ⚠ Provided with hydraulic interceptions to the outside of the unit (option 'CSVX - A pair of manually operated shut-off valves') to facilitate any major maintenance operations
- ⚠ It is necessary to provide a non-return valve for each unit installed in hydraulic parallel and equipped with an hydronic assembly installed on board (Installation by the Customer).

Electrical data Hydropack

PUMP	Rated power [kW]	Nominal Current [A]
2PMV 80.3 - 100.4 EXC / 90.3 - 110.4 PRM	2 x 2,2	2 x 4,56
2PMV 115.4 ÷ 185.5 EXC / 130.4 ÷ 210.6 PRM	2 x 4	2 x 7,62
2PMV 210.6 ÷ 240.6 EXC / 225.6 - 240.6 PRM	2 x 5,5	2 x 10,5

PUMP	Rated power [kW]	Nominal Current [A]
2PMVH 80.3 - 100.4 EXC / 90.3 - 110.4 PRM	2 x 4	2 x 7,62
2PMVH 115.4 - 130.4 EXC / 130.4 - 145.4 PRM	2 x 5,5	2 x 10,5
2PMVH 155.5 ÷ 210.6 EXC / 170.5 - 185.5 PRM	2 x 7,5	2 x 14,1
2PMVH 225.6 - 240.6 EXC / 210.6 ÷ 240.6 PRM	2 x 11	2 x 20,2

2PMV - HYDROPACK WITH N° 2 INVERTER PUMPS

Head - Size 80.3 - 100.4 EXC / 90.3 - 110.4 PRM

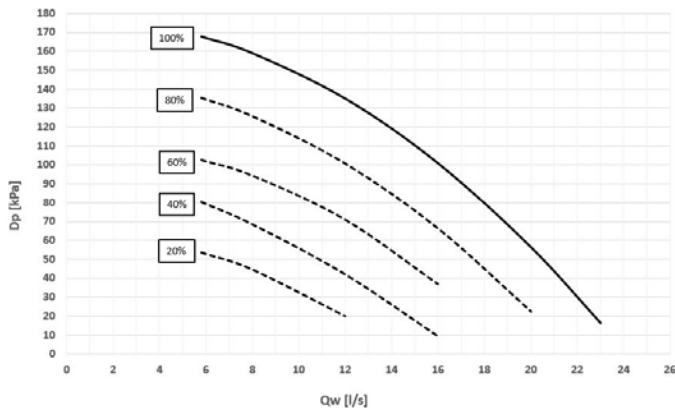

Dp = Pump head [kPa]
QW = Water flow-rate [l/s]

Power input - Size 80.3 - 100.4 EXC / 90.3 - 110.4 PRM

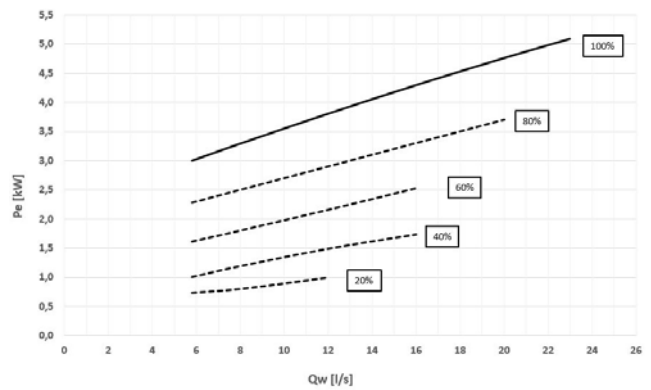

Pe = Power input [kW]
QW = Water flow-rate [l/s]

Head - Size 115.4 ÷ 185.5 EXC / 130.4 ÷ 210.6 PRM

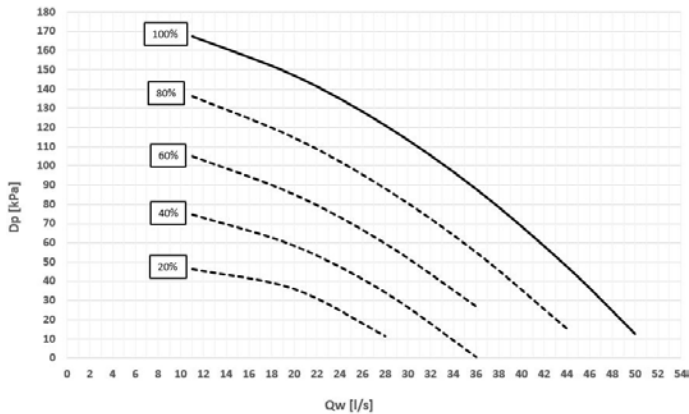

Dp = Pump head [kPa]
QW = Water flow-rate [l/s]

Power input - Size 115.4 ÷ 185.5 EXC / 130.4 ÷ 210.6 PRM

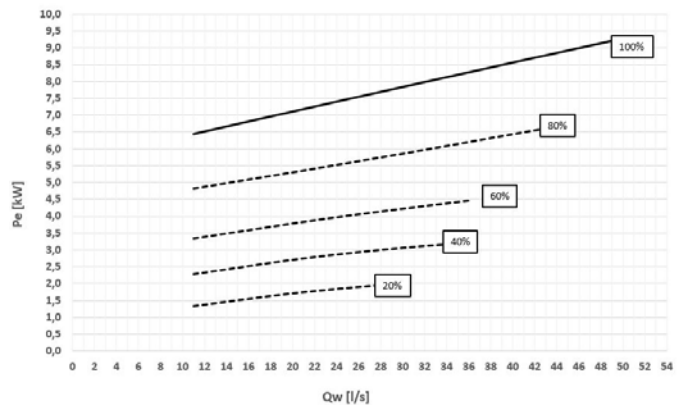

Pe = Power input [kW]
QW = Water flow-rate [l/s]

Head - Size 210.6 ÷ 240.6 EXC / 225.6 - 240.6 PRM

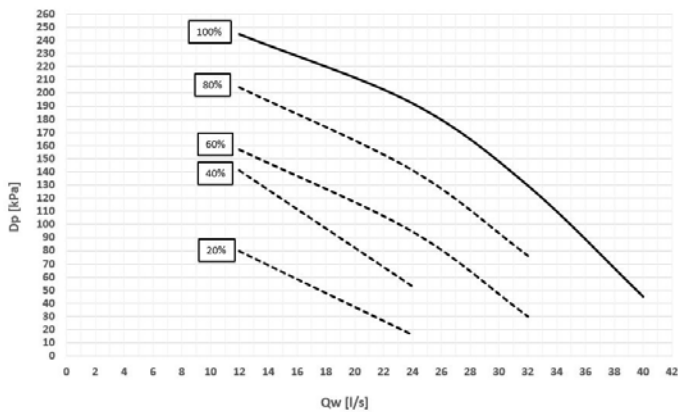

Dp = Pump head [kPa]
QW = Water flow-rate [l/s]

Power input - Size 210.6 ÷ 240.6 EXC / 225.6 - 240.6 PRM

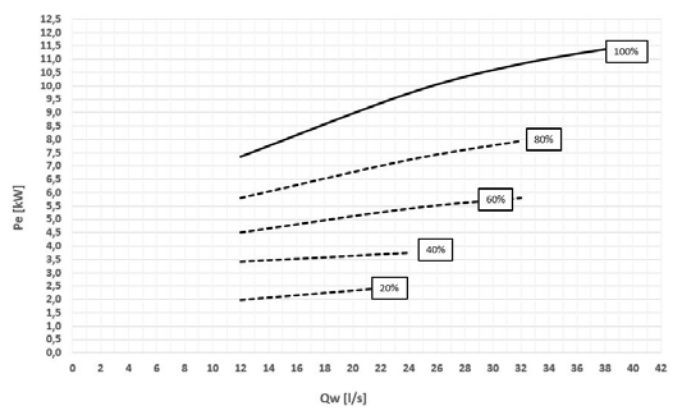

Pe = Power input [kW]
QW = Water flow-rate [l/s]

⚠ Caution: to obtain the available pressure values, you need to subtract the following from the head values represented in these diagrams:
Internal exchanger pressure drop
IFVX accessory –Steel mesh filter on the water side (where applicable)

Accessories - Hydronic assembly

2PMVH - HYDROPACK WITH N° 2 HIGH STATIC PRESSURE INVERTER PUMPS

Head - Size 80.3 - 100.4 EXC / 90.3 - 110.4 PRM

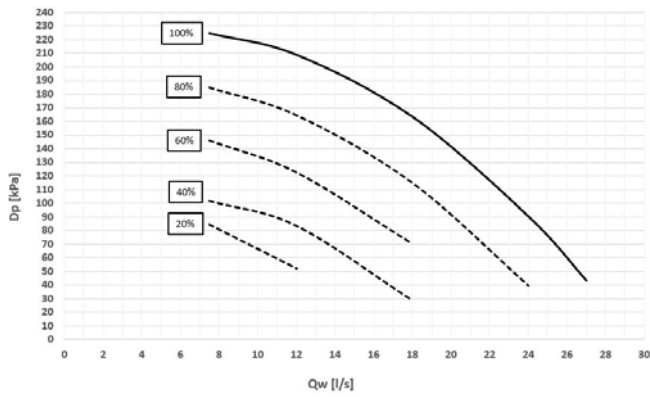

Dp = Pump head [kPa]
QW = Water flow-rate [l/s]

Power input - Size 80.3 - 100.4 EXC / 90.3 - 110.4 PRM

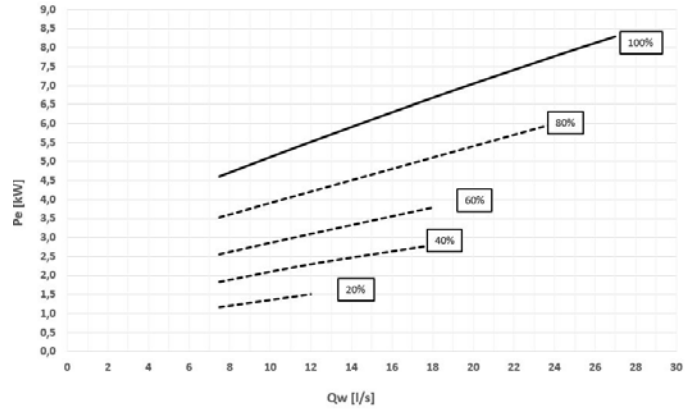

Pe = Power input [kW]
QW = Water flow-rate [l/s]

Head - Size 115.4 - 130.4 EXC / 130.4 - 145.4 PRM

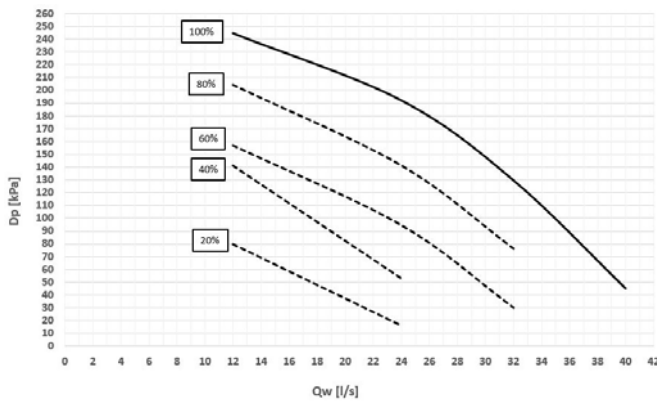

Dp = Pump head [kPa]
QW = Water flow-rate [l/s]

Power input - Size 115.4 - 130.4 EXC / 130.4 - 145.4 PRM

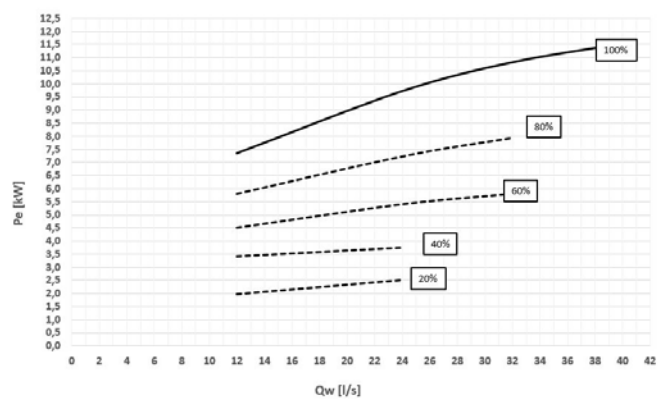

Pe = Power input [kW]
QW = Water flow-rate [l/s]

Head - Size 155.5 ÷ 210.6 EXC / 170.5 - 185.5 PRM

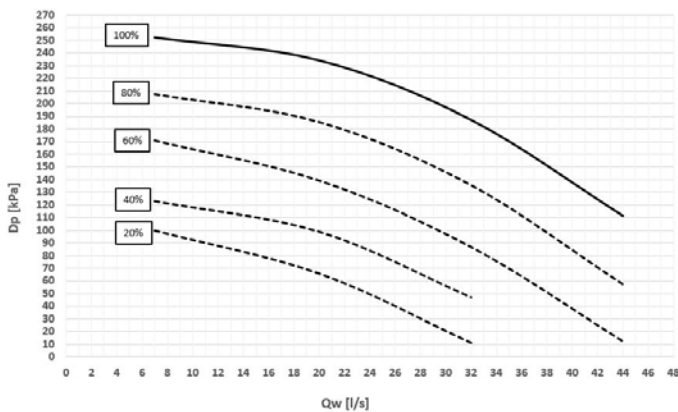

Dp = Pump head [kPa]
QW = Water flow-rate [l/s]

Power input - Size 155.5 ÷ 210.6 EXC / 170.5 - 185.5 PRM

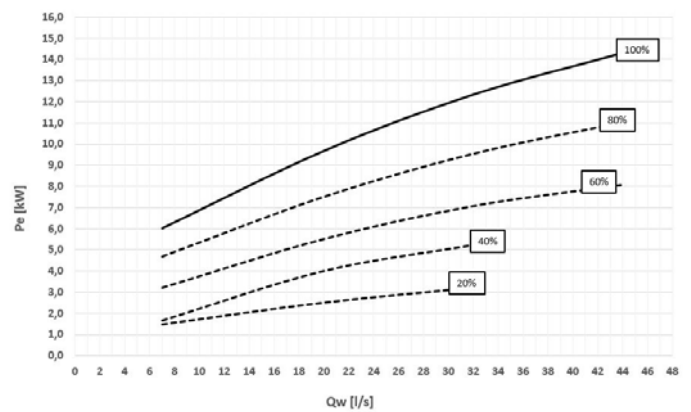

Pe = Power input [kW]
QW = Water flow-rate [l/s]

2PMVH - HYDROPACK WITH N° 2 HIGH STATIC PRESSURE INVERTER PUMPS

Head - Size 225.6 - 240.6 EXC / 210.6 ÷ 240.6 PRM

Power input - Size 225.6 - 240.6 EXC / 210.6 ÷ 240.6 PRM

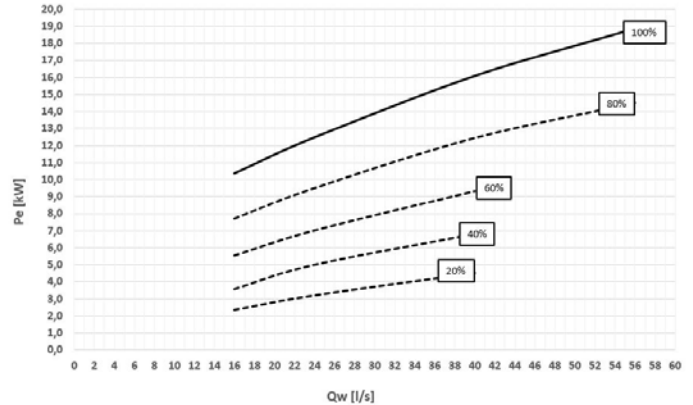
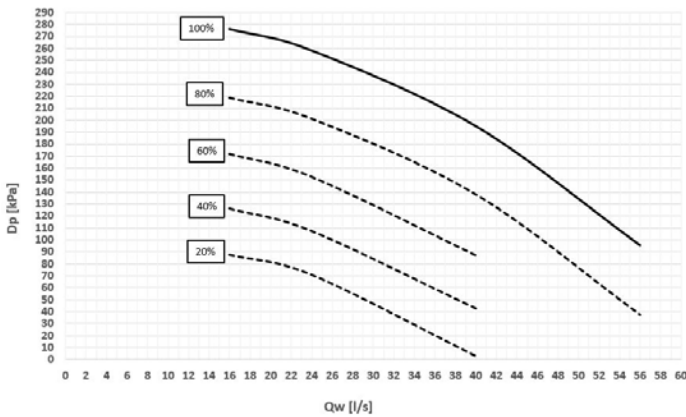

Dp = Pump head [kPa]
QW = Water flow-rate [l/s]

Pe = Power input [kW]
QW = Water flow-rate [l/s]

⚠ Caution: to obtain the available pressure values, you need to subtract the following from the head values represented in these diagrams:
Internal exchanger pressure drop
IFVX accessory –Steel mesh filter on the water side (where applicable)

ACC - Storage tank

Steel storage tank complete with double layer covering with closed-cell insulation, stainless steel anti-freeze immersion resistance, bleed valve, draw off cock, cast-iron shut-off butterfly valve with quick connections and activation lever with a mechanical calibration lock at the evaporator output, quick connections with insulated casing.

Sizes 80.3 and 100.4 excellence and 90.3, 110.4 and 130.4 premium: the storage tank capacity is 420 liters.

Sizes 115.4, 130.4 excellence and 145.4, 170.5 and 185.5 premium: the storage tank capacity is 500 liters.

Sizes 155.5, 170.5 and 185.5 excellence and 210.6, 225.6 and 240.6 premium: the storage tank capacity is 780 liters.

Sizes 210.6, 225.6 and 240.6 excellence: the storage tank capacity is 1050 liters.

The device is installed and wired built-in the unit, and is placed on the return from the system.

CONNECTION DIAGRAM

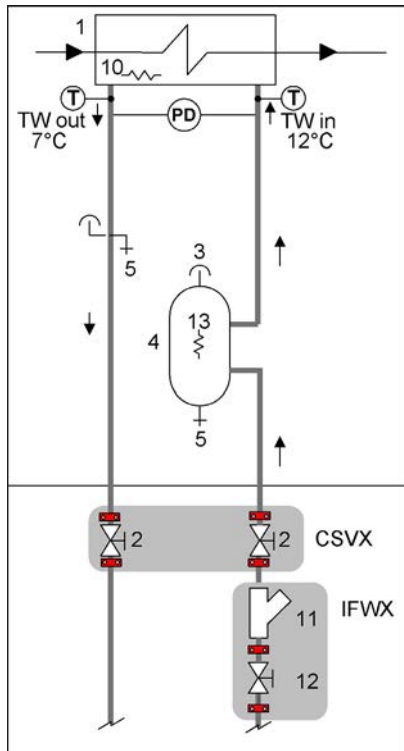

- 1 - Internal exchanger
- 2 - Cutoff valve - (CSVX - Couple of manually operated shut-off valve)
- 3 - Purge valve
- 4 - Storage tank
- 5 - Discharge stop valve
- 10 - Exchanger antifreeze heater
- 11 - Steel mesh strainer water side - (IFWX)
- 12 - Cutoff valve with quick joints
- 13 - Immersion antifreeze heater

T - Temperature probe
PD - Differential pressure switch

TW in chilled water inlet
TW out chilled water outlet

The grey area indicates further optional components.

⚠ Provided with hydraulic interceptions to the outside of the unit (option 'CSVX - A pair of manually operated shut-off valves') to facilitate any major maintenance operations

Arrangement of hydronic groups

Unit with shell and tube exchanger and built in hydronic assembly:

The hydronic assemblies are supplied as an built-in options.

Compared to the standard unit, the length of the unit complete with hydronic assembly in combination with the shell and tube exchanger (EVFTP) varies according to the following indications:

Size 80.3÷ 100.4 Excellence and 90.3 ÷ 130.4 Premium: Increases by 1 meter

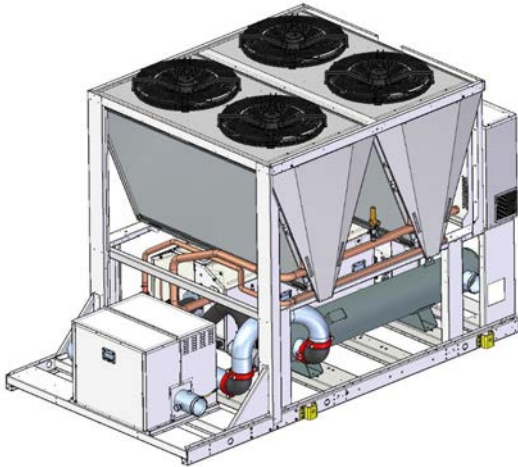

SIZE - EXCELLENCE

		80.3	100.4
Unit length with plate heat exchanger and any built in hydronic assembly	[mm]	2925	2925
Unit length with shell & tube exchanger and any built in hydronic assembly	[mm]	3925	3925

SIZE - PREMIUM

		90.3	110.4	130.4
Unit length with plate heat exchanger and any built in hydronic assembly	[mm]	2925	2925	2925
Unit length with shell & tube exchanger and any built in hydronic assembly	[mm]	3925	3925	3925

For all other sizes, the Length remains unchanged

- ⚠ With the standard acoustic configuration, if the hydronic assemblies are installed on board, they are supplied without casing.
- ⚠ With the acoustic configuration with compressor soundproofing if the hydronic assemblies are installed on board, they are supplied without casing.
- ⚠ With the super-silenced acoustic configuration, if the hydronic assemblies are installed on board, they are supplied with casing.

Option compatibility

REF	DESCRIPTION	80.3	90.3	100.4	110.4	115.4	130.4	145.4	155.5	170.5	185.5	210.6	225.6	240.6
Configurations and main accessories														
B	Low water temperature	0	0	0	0	0	0	0	0	0	0	0	0	0
D	Partial energy recovery	0	0	0	0	0	0	0	0	0	0	0	0	0
R	Total energy recovery	0	0	0	0	0	0	0	0	0	0	0	0	0
B + D	Low water temperature + Partial energy recovery	0	0	0	0	0	0	0	0	0	0	0	0	0
B + R	Low water temperature + Total energy recovery	-	-	-	-	-	-	-	-	-	-	-	-	-
ACC	Storage tank	0	0	0	0	0	0	0	0	0	0	0	0	0
EVFTP	Shell and tube evaporator PED test	0	0	0	0	0	0	0	0	0	0	0	0	0
1PM	Hydropack with n° 1 pump	0	0	0	0	0	0	0	0	0	0	0	0	0
2PM	Hydropack with n° 2 pumps	0	0	0	0	0	0	0	0	0	0	0	0	0
1PMV	Hydropack with n° 1 inverter pump	0	0	0	0	0	0	0	0	0	0	0	0	0
2PMV	Hydropack with n° 2 inverter pumps	0	0	0	0	0	0	0	0	0	0	0	0	0
1PMH	Hydropack with n° 1 high static pressure pump	0	0	0	0	0	0	0	0	0	0	0	0	0
2PMH	Hydropack with n° 2 high static pressure pumps	0	0	0	0	0	0	0	0	0	0	0	0	0
1PMVH	Hydropack with n° 1 high static pressure inverter pump	0	0	0	0	0	0	0	0	0	0	0	0	0
2PMVH	Hydropack with n° 2 high static pressure inverter pumps	0	0	0	0	0	0	0	0	0	0	0	0	0
EVFTP - Shell and tube evaporator PED test														
+R	+ Total energy recovery	-	-	-	-	-	-	-	-	-	-	-	-	-
+ ACC	+ Storage tank	-	-	-	-	-	-	-	-	-	-	-	-	-
1PM / 1PMH / 1PMV / 1PMVH														
+ ACC + D	+ Storage tank + Partial energy recovery	-	-	-	-	-	-	-	-	-	-	-	-	-
+ ACC + R	+ Storage tank + Total energy recover	-	-	-	-	-	-	-	-	-	-	-	-	-
2PM / 2PMH / 2PMV / 2PMVH														
+ ACC + D	+ Storage tank + Partial energy recovery	-	-	-	-	-	-	-	-	-	-	-	-	-
+ ACC + R	+ Storage tank + Total energy recover	-	-	-	-	-	-	-	-	-	-	-	-	-
IVFDT - Inverter driven variable flow-rate user side control depending on the temperature differential														
(1PM) (2PM)	Hydropack with n°1 pump / Hydropack user side with n°2 pumps	-	-	-	-	-	-	-	-	-	-	-	-	-
(1PMH) (2PMH)	Hydropack with n°1 high static pressure pump / Hydropack user side with n°2 high static pressure pumps	-	-	-	-	-	-	-	-	-	-	-	-	-
(1PMV) (2PMV)	Hydropack user side with n°1 inverter pump / Hydropack user with n°2 inverter pumps	0	0	0	0	0	0	0	0	0	0	0	0	0
(1PMVH) (2PMVH)	Hydropack userside with n°1 high static pressure inverter pump/ Hydropack user side with n°2 high static pressure inverter pumps	0	0	0	0	0	0	0	0	0	0	0	0	0
Other accessories														
CREFB	Device for fan consumption reduction of the external section, ecobreeze type	●	●	●	●	●	●	●	●	●	●	●	●	●
SFSTR	Disposal for inrush current reduction	0	0	0	0	0	0	0	0	0	0	0	0	0

0 Option
 - Not available
 ● Standard

Dimensional drawings

SIZE 80.3 - 100.4 EXC / 90.3 ÷ 130.4 PRM

DAAT40001_00
DATA/DATE 10/03/2020

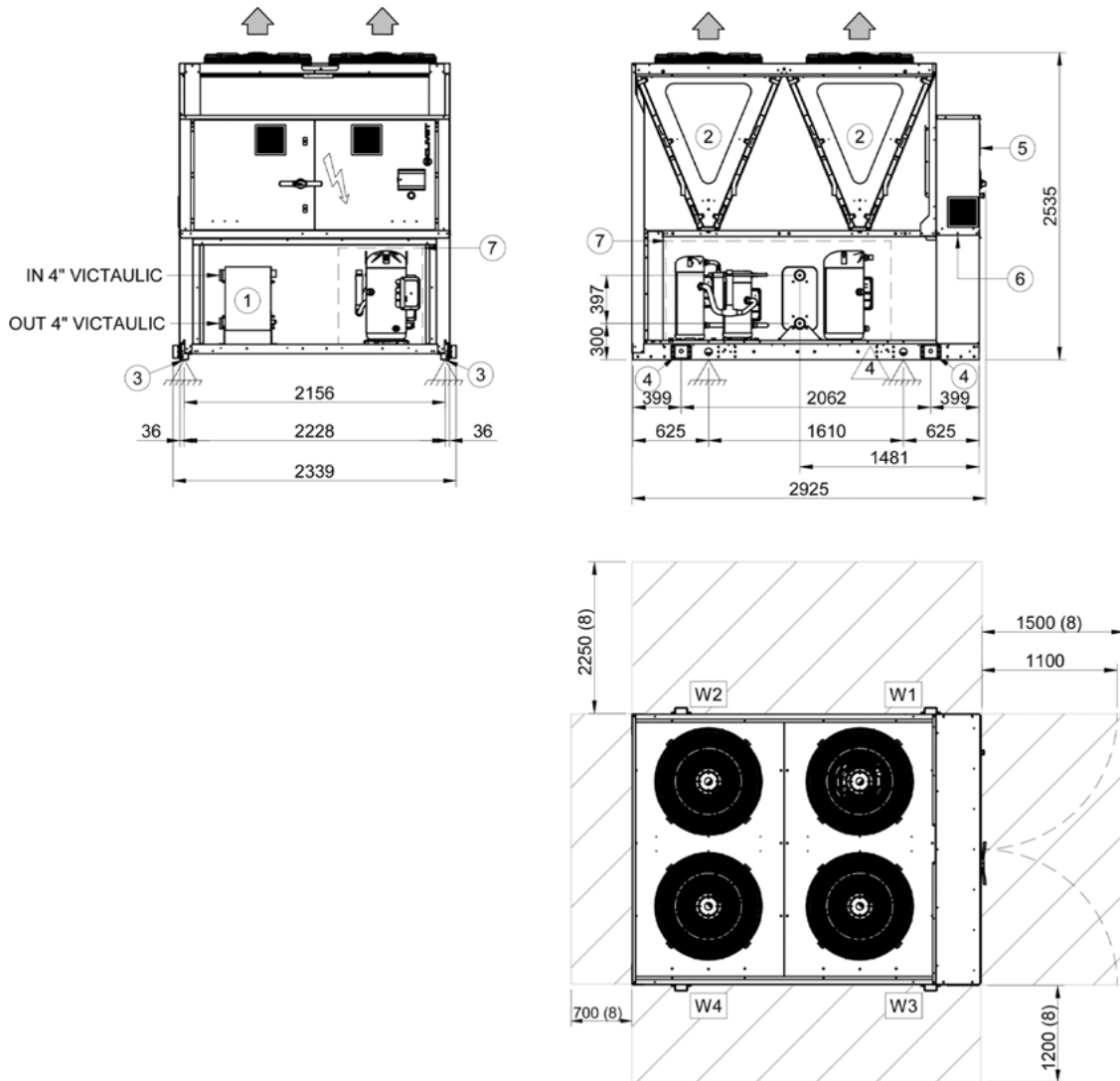

1. Internal exchanger (evaporator)
2. External exchanger (condenser)
3. Unit fixing holes
4. Lifting brackets (removable)
5. Electrical panel
6. Power input
7. Sound proof enclosure (optional)
8. Clearance access recommended

SIZE		80.3 EXC		100.4 EXC		90.3 PRM		110.4 PRM		130.4 PRM	
		ST	SC/EN	ST	SC/EN	ST	SC/EN	ST	SC/EN	ST	SC/EN
Length	mm	2925	2925	2925	2925	2925	2925	2925	2925	2925	2925
Depth	mm	2228	2228	2228	2228	2228	2228	2228	2228	2228	2228
Height	mm	2535	2535	2535	2535	2535	2535	2535	2535	2535	2535
W1 Supporting point	kg	450	509	463	522	485	544	504	563	526	585
W2 Supporting point	kg	432	494	431	493	406	468	455	517	505	567
W3 Supporting point	kg	413	446	423	456	446	479	450	483	458	491
W4 Supporting point	kg	395	431	391	427	367	403	401	437	437	473
Operating weight	kg	1689	1879	1708	1898	1703	1893	1810	2000	1926	2116
Shipping weight	kg	1628	1818	1647	1837	1642	1832	1749	1939	1868	2058

The presence of optional accessories may result in a substantial variation of the weights shown in the table.

Dimensional drawings

SIZE 115.4 - 130.4 EXC / 145.4 PRM

DAAT40002_00
DATA/DATE 29/11/2020

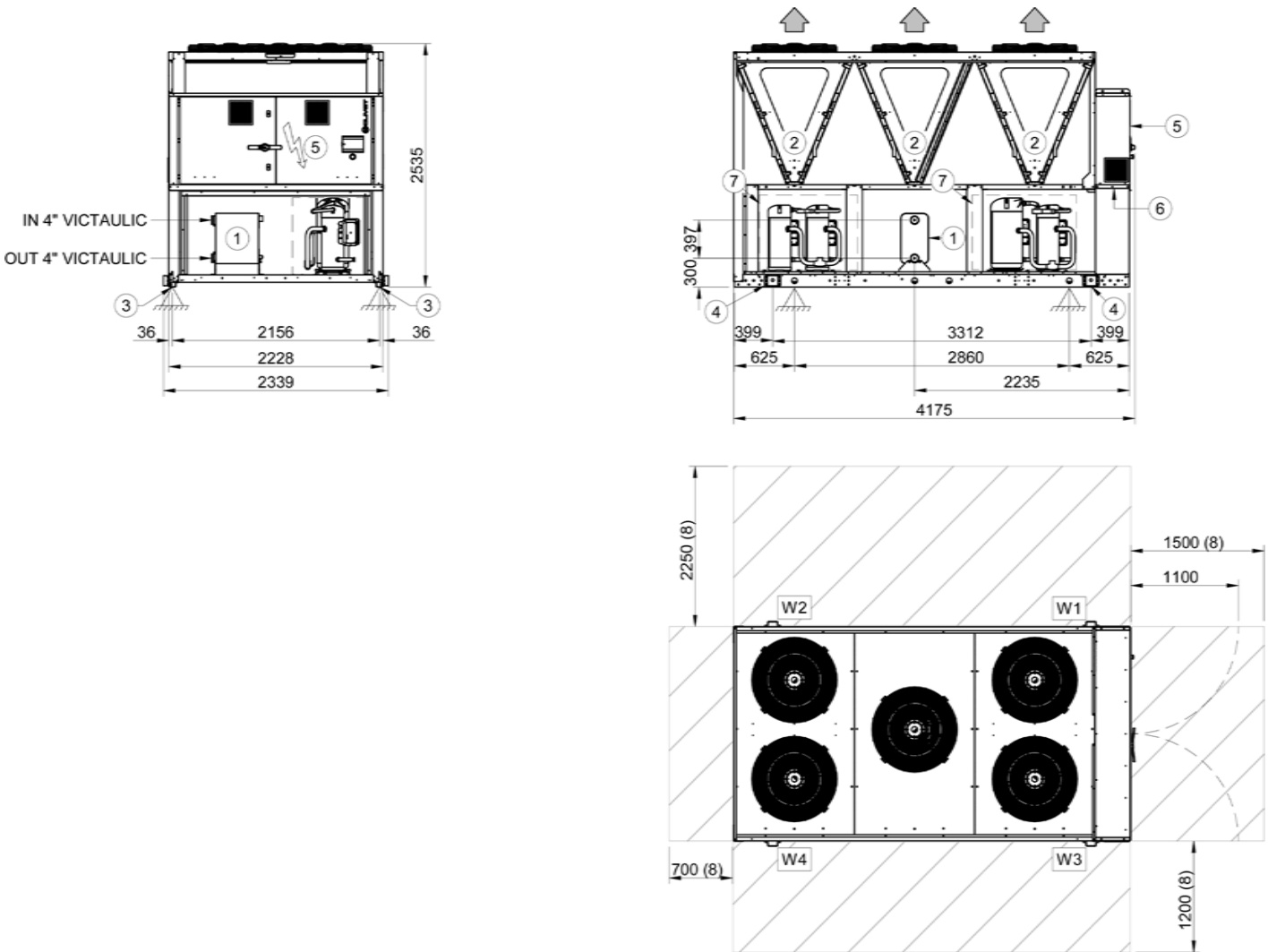

1. Internal exchanger (evaporator)
2. External exchanger (condenser)
3. Unit fixing holes
4. Lifting brackets (removable)
5. Electrical panel
6. Power input
7. Sound proof enclosure (optional)
8. Clearance access recommended

SIZE		115.4 EXC		130.4 EXC		145.4 PRM	
		ST	SC/EN	ST	SC/EN	ST	SC/EN
Length	mm	4175	4175	4175	4175	4175	4175
Depth	mm	2228	2228	2228	2228	2228	2228
Height	mm	2535	2535	2535	2535	2535	2535
W1 Supporting point	kg	588	647	640	700	654	713
W2 Supporting point	kg	542	607	577	642	619	684
W3 Supporting point	kg	531	566	570	605	569	604
W4 Supporting point	kg	485	525	507	547	534	575
Operating weight	kg	2145	2345	2294	2494	2376	2576
Shipping weight	kg	2115	2315	2254	2454	2336	2536

The presence of optional accessories may result in a substantial variation of the weights shown in the table.

Dimensional drawings

SIZE 170.5 - 180.5 PRM

DAAT40003_00
DATA/DATE 19/03/2020

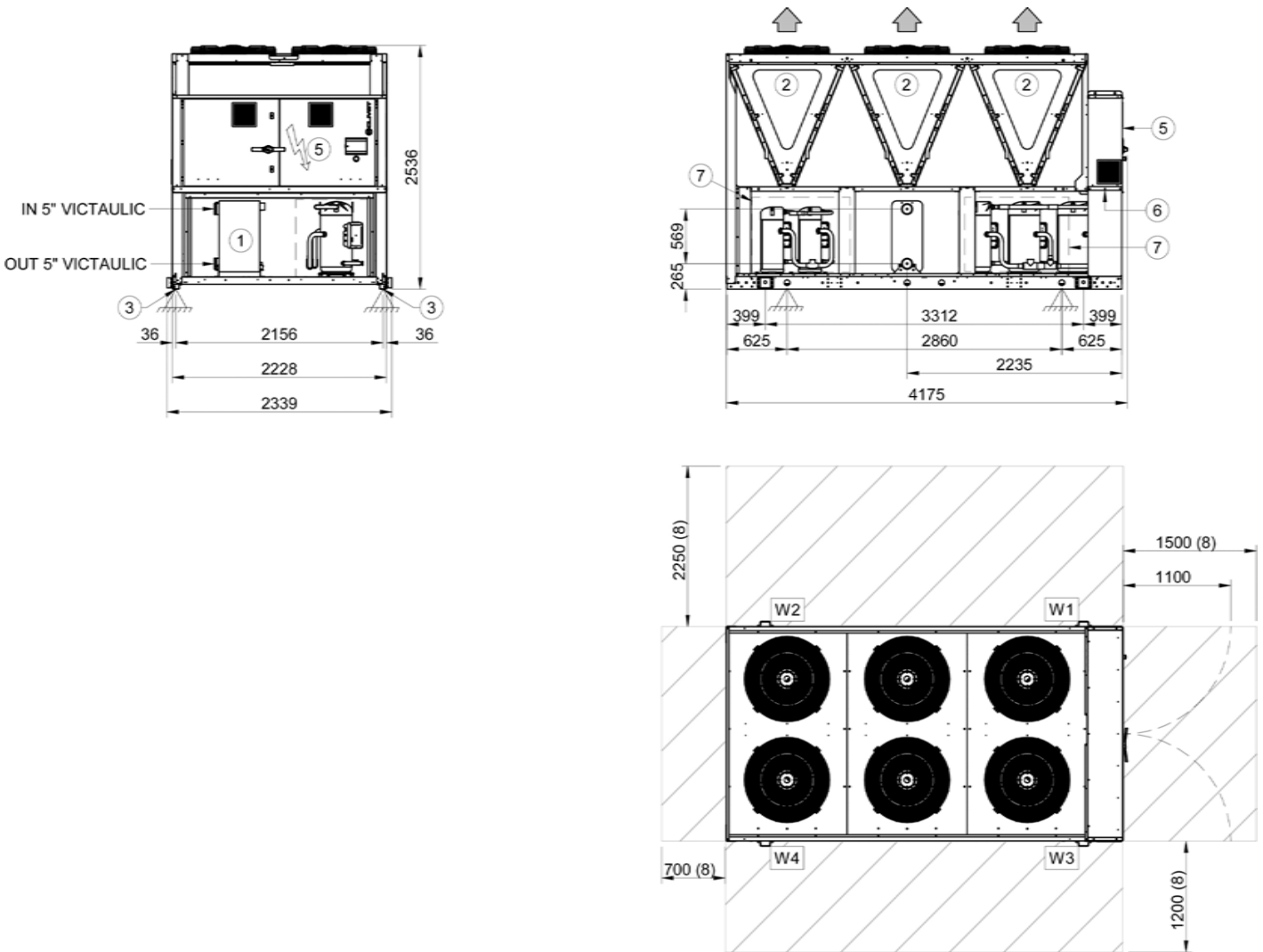

1. Internal exchanger (evaporator)
2. External exchanger (condenser)
3. Unit fixing holes
4. Lifting brackets (removable)
5. Electrical panel
6. Power input
7. Sound proof enclosure (optional)
8. Clearance access recommended

SIZE		170.5 PRM		185.5 PRM	
		ST	SC/EN	ST	SC/EN
Length	mm	4175	4175	4175	4175
Depth	mm	2228	2228	2228	2228
Height	mm	2535	2535	2535	2535
W1 Supporting point	kg	741	806	777	841
W2 Supporting point	kg	632	693	697	757
W3 Supporting point	kg	649	689	672	712
W4 Supporting point	kg	540	576	592	628
Operating weight	kg	2563	2763	2738	2938
Shipping weight	kg	2513	2713	2678	2878

The presence of optional accessories may result in a substantial variation of the weights shown in the table.

Dimensional drawings

SIZE 155.5 ÷ 185.5 EXC / 210.6 ÷ 240.6 PRM

DAAT40006_00
DATA/DATE 08/07/2020

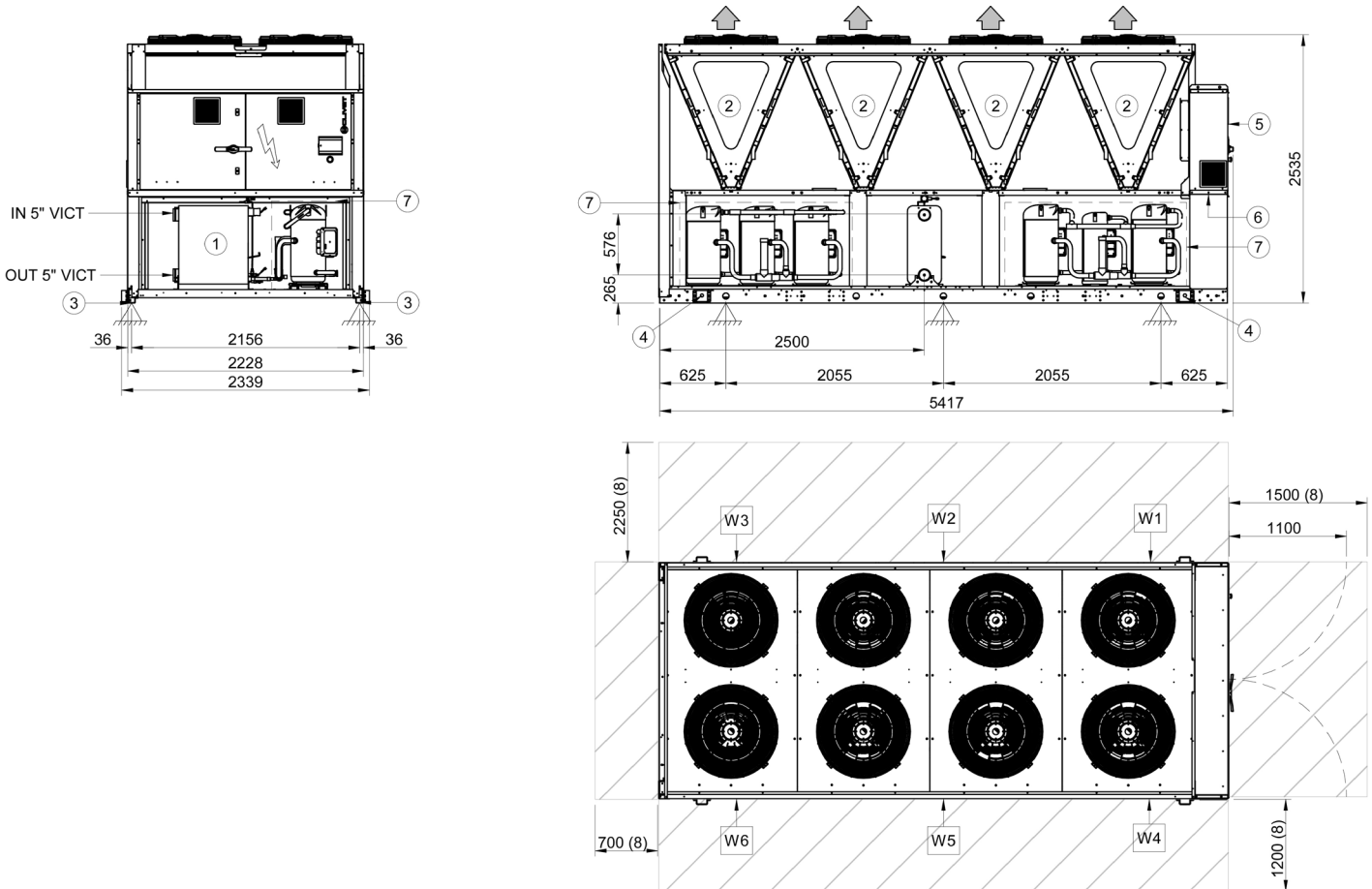

1. Internal exchanger (evaporator)
2. External exchanger (condenser)
3. Unit fixing holes
4. Lifting brackets (removable)
5. Electrical panel
6. Power input
7. Sound proof enclosure (optional)
8. Clearance access recommended

SIZE		155.5 EXC		170.5 EXC		185.5 EXC		210.6 PRM		225.6 PRM		240.6 PRM	
		ST	SC/EN	ST	SC/EN	ST	SC/EN	ST	SC/EN	ST	SC/EN	ST	SC/EN
Length	mm	5417	5417	5417	5417	5417	5417	5417	5417	5417	5417	5417	5417
Depth	mm	2228	2228	2228	2228	2228	2228	2228	2228	2228	2228	2228	2228
Height	mm	2535	2535	2535	2535	2535	2535	2535	2535	2535	2535	2535	2535
W1 Supporting point	kg	601	651	599	649	603	653	606	611	660	710	659	708
W2 Supporting point	kg	606	658	645	697	677	729	663	670	725	780	748	803
W3 Supporting point	kg	345	395	415	465	481	531	541	546	545	608	608	672
W4 Supporting point	kg	428	443	427	442	432	448	437	442	458	474	459	474
W5 Supporting point	kg	519	535	561	577	593	609	553	561	606	623	621	638
W6 Supporting point	kg	281	297	305	321	328	344	341	346	348	368	370	389
Operating weight	kg	2779	2979	2952	3152	3114	3314	3141	3176	3343	3563	3464	3684
Shipping weight	kg	2729	2929	2892	3092	3044	3244	3085	3120	3277	3497	3394	3614

The presence of optional accessories may result in a substantial variation of the weights shown in the table.

Dimensional drawings

SIZE 210.6 ÷ 240.6 EXC

DAAT40004_00
DATA/DATE 19/05/2020

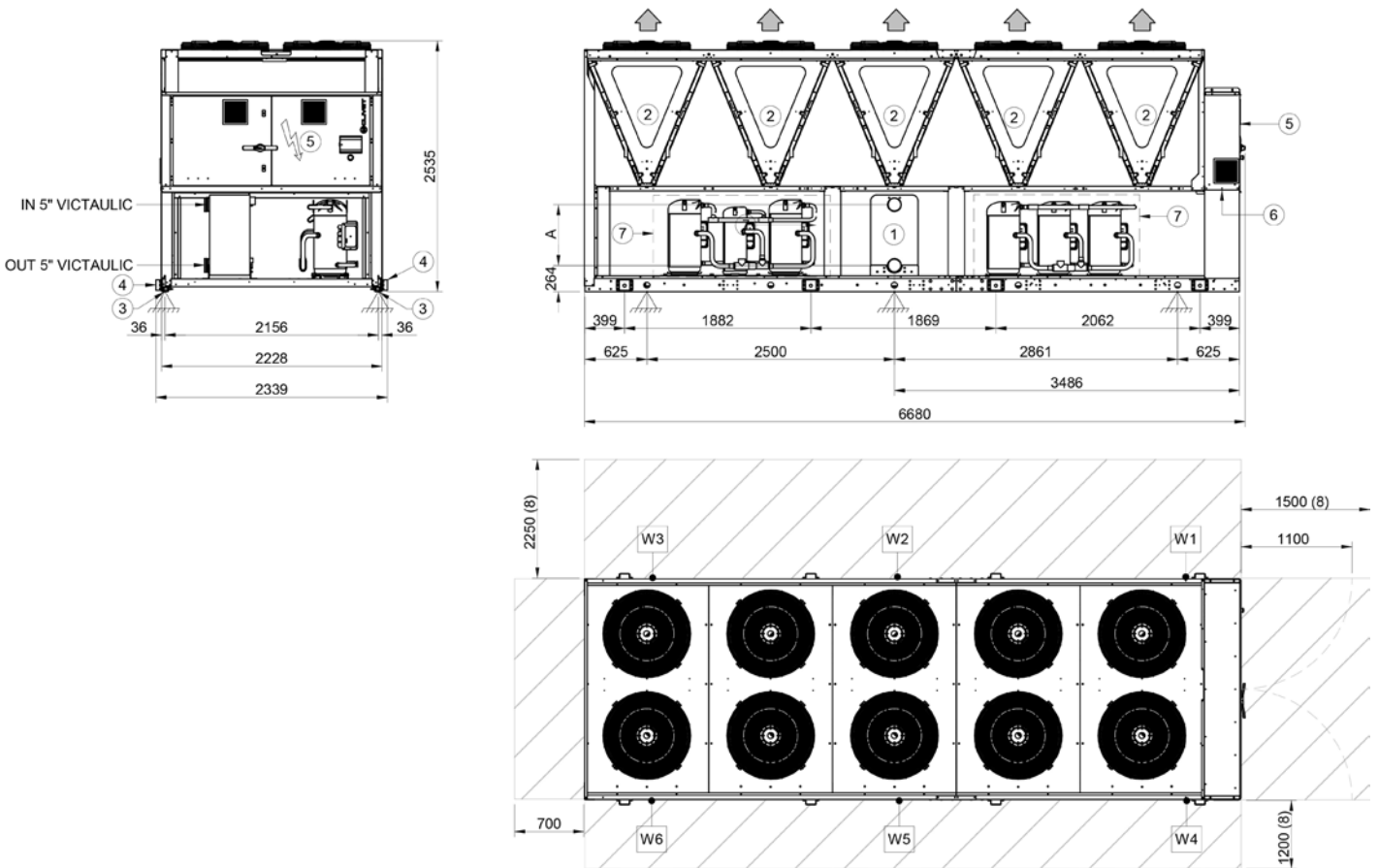

1. Internal exchanger (evaporator)
2. External exchanger (condenser)
3. Unit fixing holes
4. Lifting brackets (removable)
5. Electrical panel
6. Power input
7. Sound proof enclosure (optional)
8. Clearance access recommended

SIZE		210.6 EXC		225.6 EXC		240.6 EXC	
		ST	SC/EN	ST	SC/EN	ST	SC/EN
Length	mm	6680	6680	6680	6680	6680	6680
Depth	mm	2228	2228	2228	2228	2228	2228
Height	mm	2535	2535	2535	2535	2535	2535
W1 Supporting point	kg	562	598	598	634	594	630
W2 Supporting point	kg	1019	1119	1060	1161	1115	1216
W3 Supporting point	kg	438	479	430	471	474	515
W4 Supporting point	kg	451	463	462	475	461	474
W5 Supporting point	kg	791	826	844	880	894	930
W6 Supporting point	kg	310	325	308	323	322	336
Operating weight	kg	3570	3810	3703	3943	3860	4100
Shipping weight	kg	3500	3740	3633	3873	3780	4020

The presence of optional accessories may result in a substantial variation of the weights shown in the table.

Page intentionally left blank

Page intentionally left blank

FOR OVER 30 YEARS WE HAVE BEEN
OFFERING SOLUTIONS TO ENSURE
SUSTAINABLE COMFORT AND THE WELL-
BEING OF PEOPLE AND THE ENVIRONMENT

www.clivet.com

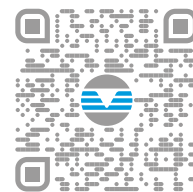

sale and assistance

SPINchiller 4 - WSAT-YSC4 - BT20H009GB-04



CLIVET SPA
Via Camp Lonc 25, Z.I. Villapaiera
32032 Feltre (BL) - Italy
Tel. +39 0439 3131 - Fax +39 0439 313300
info@clivet.it

MideaGroup
humanizing technology