

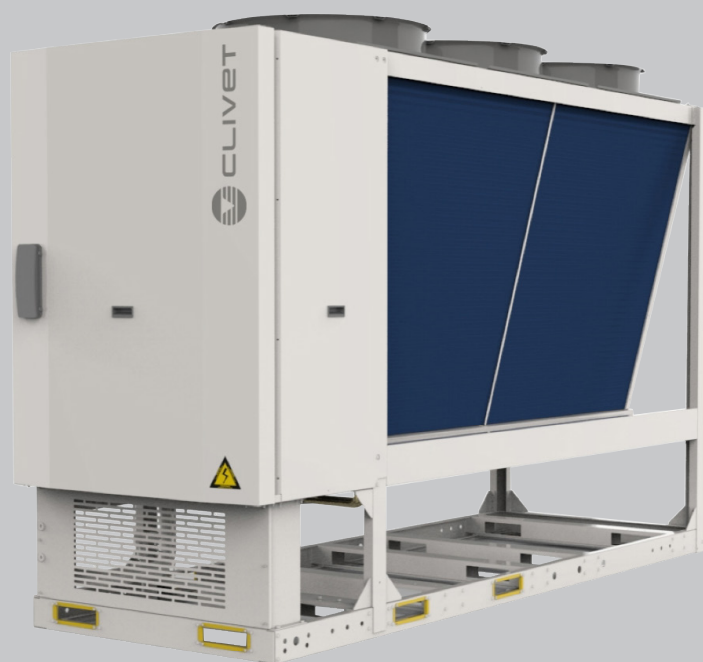

*Air source inverter
FREE-COOLING, liquid chiller
for outdoor installation*

ELFOEnergy STORM EVO FC WSAT-YES FC 18.2 - 35.2 RANGE



TECHNICAL BULLETIN



SIZE	18.2	20.1	25.2	30.2	35.2
COOLING CAPACITY KW	50,4	56,2	68,6	73,6	80,8

Page

3	Features and benefits
4	Standard unit technical specifications
5	Unit configuration
6	Built-in options
7	Options separately supplied
8	General technical data
13	Configurations
18	Performances
23	Modularity
24	Dimensionals drawings



Clivet is taking part in the EUROVENT certification programme up to 1.500 kW.
The products concerned appear in the certified products list of the EUROVENT
www.eurovent-certification.com site.

Features and benefits

ELFOEnergy Storm EVO series is the new air liquid chiller FREE-COOLING equipped with Full DC Inverter technology and R32 refrigerant, for outdoor installation. It is available from 50 kW up to 81 kW and is the most effective and valuable solution both in terms of capital investment and running costs.

Energy efficiency

Class C Eurovent at full load in heating and in cooling.

SEPR up to 5,84.

Capacity modulation from 30% to 100%.

Wide operating range

Outdoor air temperature	max	min
cooling	48°C	-25°C
Outlet water temperature	max	min
cooling	20°C	5°C

Functionality

Climate compensation with outdoor temperature.

ECO mode

- temperature set for maximum comfort (for example during the day)
- temperature set for maximum energy saving (for example at night)
- time bands and customizable temperatures

SILENT mode

- speed reduction of compressors and fans
- three levels of silence: standard mode, silenced, super silenced

Modular design

ELFOEnergy Storm EVO was designed for modularity.

It is possible to connect up to 16 units in a local network, reaching a maximum capacity of 1360 kW and up to 4 units connected hydraulically.

The combinations can also take place with different capacity units.

The modular system, obtained by combining several modules, preserves the strengths of the single module, but multiplies the advantages:

- Increased system efficiency
- Higher reliability
- Simplified handling and installation
- Quick and easy maintenance
- Scalability

Application Versatility

All the main system components are integrated in the unit, assuring the best reliability and an easy installation:

- Hydronic assembly with 1 inverter pump
- System storage tank: 170 (size 18.2-20.2) or 275 liters (size 25.2-30.2-35.2)

Technology

The technical solutions adopted place ELFOEnergy Storm EVO on top of its category:

- DC inverter technology on compressors and fans
- Electronic expansion valve
- Flow switch
- Microchannel coil

Perfect for LEED

All models satisfy prerequisites 2 (Minimum Energy Performance) and 3 (Fundamental Refrigerant Management) of Energy and Environment thematic area of LEED certification.

Direct free-cooling

For systems with glycol as antifreeze.

An optimized Free-cooling section drives to nominal capacity with compressors OFF up to 1,6°C outdoor air temperature.

Compressor

Size 18.2 - 20.2

Inverter controlled rotary-type hermetic compressor equipped with a motor protection device for overheating, overcurrents and excessive temperatures of the supply gas. It is installed on anti-vibration mounts and it is equipped with oil charge. The compressor is wrapped in a sound-absorbing hood, that reduces its sound emissions and it thermally insulates it. A crankcase heater, which starts automatically, keeps the oil from being diluted by the refrigerant when the compressor stops.

Compressors are connected in tandem on a single refrigerating circuit with a dedicated system for the oil recovery.

Size 25.2 - 30.2 - 35.2

Scroll hermetic compressor with steam injection controlled by inverter, complete with motor over-temperature and over-current devices and protection against excessive gas discharge temperature. It is installed on anti-vibration mounts and it is equipped with oil charge. The compressor is wrapped in a sound-absorbing hood, that reduces its sound emissions and it thermally insulates it. A crankcase heater, which starts automatically, keeps the oil from being diluted by the refrigerant when the compressor stops.

Compressors are connected in tandem on a single refrigerating circuit with a dedicated system for the oil recovery.

Structure

Supporting structure realised with steel with zinc-magnesium superficial treatment painted with polyester powder RAL 9001, that ensures excellent mechanical features and high long-term resilience against corrosion.

Panelling

External RAL 9001 painted zinc-magnesium sheet metal panelling that ensures superior resistance to corrosion for outdoor installation and eliminates the need for periodic painting. Each panel can be easily removed to allow full access to internal components.

Internal exchanger

Direct expansion heat exchanger, brazed AISI 316 stainless steel plates, in pack without seals using copper as the brazing material, with low refrigerant charge and large exchange surface.

The exchanger comes complete with:

- external thermal insulation no-condensation, thickness 17 mm, in expanded polypropylene (EPP)
- antifreeze heater to protect the water side exchanger, preventing the formation of frost if the water temperature falls below a set value.
- flow switch
- anti-ice probe

External exchanger

Full aluminium microchannel coil with V structure open angle geometry. The entire exchanger (tubes, fins and manifolds) is made of aluminum and welded into a single body through a special brazing technology in a controlled-temperature chamber. The fins have a special corrugated surface to ensure maximum heat exchange efficiency. The special flat configuration of the pipes reduces the section that opposes to the air flow, limiting the pressure drops and maximizing the surface. The total refrigerant charge into the microchannel coil is reduced by 30% compared to an equivalent copper coil.

Direct FREE-COOLING

Finned coil water-air free-cooling heat exchanger, made with copper pipes arranged on staggered rows and mechanically expanded for improved adherence to the fin collar.

Exclusive components of the direct free-cooling system: - three-way valve with on/off control. The configuration allows for saving considerably on the system's management costs for applications requiring chilled water even during the cold season, for example

industrial processes, data centres, telecommunications facilities, technological applications and shopping centres.

The liquid in the free-cooling coil must be protected against frost, which can normally be done by adding an appropriate anti-freeze substance such as ethylene glycol.

The percentage of glycol in the solution depends on the minimum expected temperature value in the zone of installation, and thus pertains to the system's essential design parameters.

Fan

Helical fans with 4 profiled blades made of reinforced plastic, directly coupled to the DC brushless motor with electronic control, IP 54 execution.

Fans are located in aerodynamically shaped structures to increase efficiency and minimize noise level, equipped with accident prevention steel guards.

Refrigeration circuit

Refrigeration circuit with:

- filter dryer
- pressure transducer (high/low)
- refrigerant temperature probe
- electronic expansion valves
- non return valve
- high pressure safety pressure switch
- low pressure safety pressure switch
- low pressure safety valve
- inlet liquid separator
- oil separator
- high compressor discharge temperature safety thermostat
- cooling system of the of the electrical control panel using undercooled liquid

Only for size 25.2 - 30.2 - 35.2:

- economiser exchanger

Electrical panel

- phase monitor
- auxiliary components protection fuse
- compressor protection fuse
- fan motor thermal protections
- interface terminal with graphic display
- intuitive graphical interface retro lighted
- display of operating status
- Unit On/Off and overload reset
- manual changing of the operating mode (hot or cold)
- management of the operating parameters
- daily, weekly programmer of temperature set-point and unit on/off
- self-diagnosis system with immediate display of the fault code
- compressor overload protection and timer
- relay for remote cumulative fault signal
- potential-free contact for remote on-off control
- potential-free contact for summer / winter change
- potential-free contacts for compressor status
- serial port with modbus port (RS485) for remote communication

Test

Unit subjected to factory-tested in specific steps and test pressure of the piping of the refrigerant circuit (with nitrogen and hydrogen), before shipping them.

Unit configuration

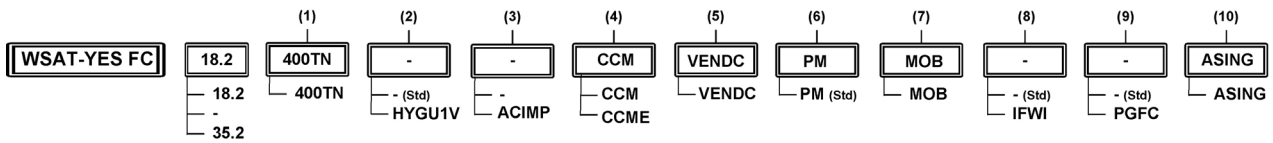

(1) Voltage

400TN - Supply voltage 400/3/50 + N (standard)

(2) User side hydronic unit

(-) not required (standard)

HYGU1V - User side hydronic assembly with 1 inverter pump

(3) Storage tank

(-) not required (standard)

ACIMP - Steel inertial storage tank

(4) Condensing coil

CCM - Microchannel condensing coil in aluminium (Standard)

CCME - E-coated microchannel coil

(5) Fans

VENDC - DC high efficiency fan (standard)

(6) Phase monitor

PM - Phase monitor (standard)

(7) Serial communication module Modbus

MOB - Serial port RS485 with modbus protocol (standard)

(8) Water side filter

(-) not required (standard)

IFWI - Steel mesh strainer on the water side

(9) Protection grill

(-) not required (standard)

PGFC - Finned coil protection grill

(10) Water fittings

ASING - Water fittings for single unit (standard)

HYGU1V	User side hydronic assembly with 1 inverter pump Hydronic unit made of a centrifugal electric pump, adjusted by way of inverter, body and propeller made in AISI 304 steel. The electric pump is equipped with three-phase electric motor with IP55 protection and complete with heat formed insulating casing. The water connection are 2" Victaulic. Hydronic unit performance is available on page 14 and 15
ACIMP	Steel inertial storage tank Option supplied built-in the unit. Steel storage tank complete with double layer covering with closed-cell insulation, stainless steel anti-freeze immersion resistance, bleed valve, draw off cock, cast-iron shut-off butterfly valve with quick connections and activation lever with a mechanical calibration lock at the evaporator output, quick connections with insulated casing. The storage tank capacity is 170 liters for size 18.2 and 20.2. The storage tank capacity is 275liters for size 25.2, 30.2 and 35.2
PGFC	Finned coil protection grill The grilles protect the external coil from accidental contact with objects or persons. Ideal for installation in places where persons can pass from, such as car parks, terraces, etc
CCME	E-coated microchannel coil The full aluminium microchannel coil is completely treated by electrolysis so as to create a protective layer of epoxy polymer on the surface, with the following characteristics: <ul style="list-style-type: none">• over 3000 hours of protection against salt spray (ASTM G85 A3 - SWAAT);• over 2000 hours of protection against UV rays (ASTM G155-05a)• provide a very high resistance against corrosion.
IFWI	Steel mesh strainer on the water side include in the packaging The device prevents the exchanger from getting dirty by any impurities present in the hydraulic circuit. The mechanical stainless steel mesh filter must be positioned on the water inlet line. It can be easily dismantled for periodic maintenance and cleaning. The water connections of the filter are Victaulic 2 ".
SNB	Main switch on board Main switch I=67A/AC23 for the unit ON/OFF and M40 fairleads, mounted on board

Options separately supplied

IFWX

Steel mesh strainer on the water side

The device stops the exchanger from being clogged by any impurities which are in the hydraulic circuit. The mechanical steel mesh strainer must be placed on the water input line. It can be easily dismantled for periodical maintenance and cleaning.

Filter fittings are Victaulic type by 2" for singular configuration and 4" for modular configuration.

Steel mesh strainer pressure drops

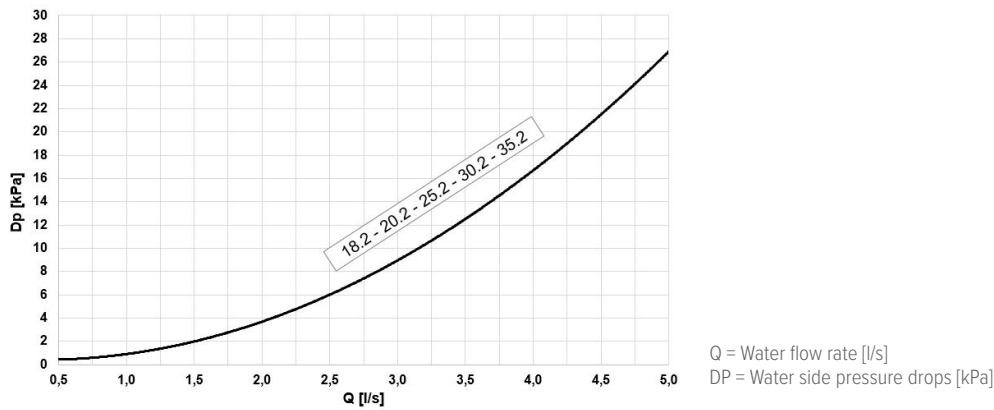

⚠ This accessory is not available for modular system.

AVIBX

Anti-vibration mount support

The rubber antivibration mounts are attached in special housing on the support frame and serve to smooth the vibrations produced by the unit thus reducing the noise transmitted to the support structure.

PGFCX

Finned coil protection grill

The grilles protect the external coil from accidental contact with objects or persons. Ideal for installation in places where persons can pass from, such as car parks, terraces, etc

AMODX

Water fitting for modular unit

In order to configure a modular system, each unit must be selected with the water connections for modular unit. The kit is made of 2 4" collectors placed horizontally and 2 butterfly valves that make it possible to exclude the unit from the modular system in case of malfunction. The water outputs remain in the same position of the individual unit, only the diameters of the pipes, which are 4", are changed.

CCKMUX

Closing caps kit for modular units

This accessory is needed to close the pipe sides not used for plant connection in the modular system. The kit is made of: 2 Victaulic caps, 2 Victaulic collars, 2 covers.

1 kit satisfies the need of a modular system with up to 4 units connected together.

SNATEX

Main switch for remote external installation

Watertight box IP54 containing n°1 main switch I=67A/AC23 for the unit ON/OFF and M40 fairleads.

REUMAX

Advanced remote control module

Multifunction board in watertight box IP56 for the advanced use of digital inputs and Modbus gateway with configurable baud rate.

The available digital inputs allow the following functions from remote:

- remote on/off
- heat/cool (summer/winter commutation)
- DHW activation (for heat pump version only)
- double set-point management
- silent mode or super silent mode activation (selectable on user interface)

The board does not allow the contemporary use of digital inputs and Modbus signal.

Performance

SIZE			18.2	20.2	25.2	30.2	35.2
Radiant panels							
Cooling							
Cooling capacity (EN 14511:2018)	kW	1/4	58,6	68,5	83,7	89,8	103
EER (EN 14511:2018)		2	4,00	3,69	4,14	3,99	3,74
Water flow-rate	l/s	1	2,8	3,3	4,0	4,3	4,9
User side exchanger pressure drops	kPa	1	30,4	40,6	41,4	47,4	61,2
Terminal unit							
Cooling							
Cooling capacity (EN 14511:2018)	kW	3	50,4	56,2	68,6	73,6	80,8
EER (EN 14511:2018)		2	2,83	2,66	2,85	2,84	2,75
SEER (EN 14511:2018)		5	4,48	4,51	4,56	4,48	4,41
$\eta_{s,c}$	%	8	190,8	190,6	192,6	189,5	186,4
SEPR		7	5,84	5,61	5,52	5,45	5,38
Water flow-rate	l/s	5	2,4	2,7	3,3	3,5	3,9
User side exchanger pressure drops	kPa	3	22,9	28,1	28,3	32,4	38,8
Dati AHRI							
Cooling capacity (AHRI 550/590)	kW	6	58,2	65,6	76,7	83,7	90,7
Total power input (AHRI 550/590)	kW	6	12,9	14,6	16,5	18,7	20,8
COP_R		6	4,51	4,50	4,64	4,48	4,36
IPLV		6	4,85	4,88	4,85	4,77	4,70

The Product is compliant with the ErP (Energy Related Products) European Directive. It includes the Commission delegated Regulation (EU) No 811/2013 (rated heat output ≤ 70 kW at specified reference conditions) and the Commission delegated Regulation (EU) No 813/2013 (rated heat output ≤ 400 kW at specified reference conditions) Contains fluorinated greenhouse gases (GWP 675)

1. Entering/leaving water temperature user side 23/18 °C, Entering external exchanger air temperature 35 °C
2. EER (EN 14511:2018) cooling performance coefficient. Ratio between delivered cooling capacity and power input in compliance with EN 14511:2018.
3. User side entering/leaving water temperature 12/7 °C, external exchanger entering air 35 °C
4. Data referred to unit operation with inverter frequency optimized for this application.
5. Data calculated according to the EN 14825:2016 Regulation
6. Data compliant to Standard AHRI 550/590 referred to the following conditions: internal exchanger water temperature = 6,7 °C. Water flow-rate 0,043 l/s per kW. Entering external exchanger air temperature 35°C. Evaporator fouling factor = $0.18 \times 10^{(-4)}$ m² K/W
7. Data compliant to EU regulation 2016/2281
8. Seasonal energy efficiency in cooling EN 14825:2018

General technical data

Construction

SIZE		18.2	20.2	25.2	30.2	35.2
Compressor						
Compressor type		ROTARY INVERTER			SCROLL INVERTER	
Refrigerant		R32				
N° compressor	Nr	2	2	2	2	2
Oil charge	l	5	5	6	6	6
Refrigerant charge	Kg	6,3	6,3	9,0	9,0	9,0
N° circuits	Nr	1	1	1	1	1
User side exchanger						
Type of internal exchanger	1	BPHE				
Water content	l	5,7	5,7	7,8	7,8	7,8
External Section Fans						
Fans type		BRUSHLESS DC MOTOR				
N° fans	Nr	2	2	3	3	3
Standard air-flow	l/s	6889	6889	10333	10333	10333
Installed unit power	kW	0,9	0,9	0,9	0,9	0,9
Water circuit						
Maximum water side pressure	MPa	1	1	1	1	1
Minimum circuit water volume in cooling	2 l	150	150	200	200	200
Total internal water volume	l	5,9	5,9	8,0	8,0	8,0
Power supply						
Standard power supply		400/3N~/50	400/3N~/50	400/3N~/50	400/3N~/50	400/3N~/50

1. BPHE = plate exchanger
2. Entering/leaving water temperature user side 15/10 °C, external exchanger entering air 25°C (U.R. = 85%) - Minimum water volume that does not consider the volume of water inside the unit.

Electrical data

Supply voltage 400/3/50+N

SIZE		18.2	20.2	25.2	30.2	35.2
F.L.A. Full load current at max admissible conditions						
F.L.A. - Total	[A]	46,0	46,0	60,2	60,2	60,2
F.L.I. Full load power input at max admissible conditions						
F.L.I. - Total	[kW]	31,8	31,8	42,0	42,0	42,0
M.I.C. Maximum inrush current						
M.I.C. - Total	[A]	46,0	46,0	60,2	60,2	60,2

Power supply 400/3/50 (+ NEUTRAL) +/- 10%.
 Maximum Phase Unbalance: 2%.
 For non standard voltage please contact Clivet technical office

Sound levels Standard mode

Size	Sound power level								Sound pressure level dB(A)	Sound power level dB(A)
	Octave band (Hz)									
	63	125	250	500	1000	2000	4000	8000		
18.2	89	81	79	79	79	72	64	57	64	82
20.2	89	83	78	78	80	72	65	58	65	82
25.2	88	81	77	80	76	70	62	56	62	81
30.2	94	86	79	82	80	73	66	60	65	84
35.2	87	77	76	76	79	68	60	53	67	85

Sound levels refer to units with nominal test conditions.
The sound pressure level refers to a distance of 1 meter from the outer surface of the unit operating in open field.
Noise levels are determined using the tensiometric method (UNI EN ISO 9614-2)

Data referred to the following conditions in cooling:
- internal exchanger water = 12/7°C
- ambient temperature 35°C

Silenced mode

Size	Sound power level								Sound pressure level dB(A)	Sound power level dB(A)
	Octave band (Hz)									
	63	125	250	500	1000	2000	4000	8000		
18.2	80	73	70	71	72	64	56	49	56	74
20.2	80	75	70	70	71	65	57	50	56	74
25.2	82	76	73	75	72	65	58	52	58	76
30.2	87	79	71	75	72	65	58	54	58	76
35.2	82	80	72	73	74	66	59	53	58	76

Livelli sonori si riferiscono ad unità alle condizioni nominali di prova.
Il livello di pressione sonora è riferito ad 1m di distanza dalla superficie esterna dell'unità funzionante in campo aperto.
Livelli di potenza sonora determinati mediante il metodo intensimetrico (UNI EN ISO 9614-2).

Dati riferiti alle seguenti condizioni in raffreddamento:
- acqua scambiatore interno 12/7° C
- temperatura aria esterna 35°C

Silenced mode can be set from the user interface terminal

Super silenced mode

Size	Sound power level								Sound pressure level dB(A)	Sound power level dB(A)
	Octave band (Hz)									
	63	125	250	500	1000	2000	4000	8000		
18.2	77	69	67	67	68	60	52	45	52	70
20.2	77	72	67	67	69	61	54	47	53	71
25.2	78	71	68	70	66	61	52	47	53	71
30.2	81	73	66	69	68	60	54	49	53	71
35.2	78	77	69	70	71	63	56	50	55	73

Sound levels refer to units with nominal test conditions.
The sound pressure level refers to a distance of 1 meter from the outer surface of the unit operating in open field.
Noise levels are determined using the tensiometric method (UNI EN ISO 9614-2)

Data referred to the following conditions in cooling:
- internal exchanger water = 12/7°C
- ambient temperature 35°C

Super Silenced mode can be set from the user interface terminal

At maximum conditions data

Size	Sound power level								Sound pressure level dB(A)	Sound power level dB(A)
	Octave band (Hz)									
	63	125	250	500	1000	2000	4000	8000		
18.2	55	65	67	72	77	70	61	50	67	83
20.2	55	65	67	72	77	70	61	50	67	83
25.2	57	67	69	73	79	72	64	51	69	85
30.2	57	67	69	73	79	72	64	51	69	85
35.2	57	67	69	73	79	72	64	51	69	85

Sound levels refer to units with nominal test conditions.
The sound pressure level refers to a distance of 1 meter from the outer surface of the unit operating in open field.
Noise levels are determined using the tensiometric method (UNI EN ISO 9614-2)

General technical data

Performance correction factors- Silenced Mode

SIZE		18.2	20.2	25.2	30.2	35.2
Cooling capacity factor	Nr	0,930	0,930	0,930	0,930	0,930
Total power input factor	Nr	1,000	1,000	1,000	1,000	1,000
EER factor	Nr	0,930	0,930	0,930	0,930	0,930

Performance correction factors - Super Silenced Mode

SIZE		18.2	20.2	25.2	30.2	35.2
Cooling capacity factor	Nr	0,880	0,880	0,880	0,880	0,880
Total power input factor	Nr	1,020	1,020	1,020	1,020	1,020
EER factor	Nr	0,860	0,860	0,860	0,860	0,860

Correction factors for glycol use

% ethylene glycol by weight		0%	10%	20%	30%	40%	50%
Freezing point	°C	0	-4	-9	-16	-23	-37
Correction factor for unit cooling capacity	Nr	1	0,984	0,973	0,965	0,96	0,95
Correction factor for flow rate	Nr	1	1,019	1,051	1,092	1,145	1,2
Correction factor for system pressure drop	Nr	1	1,118	1,268	1,482	1,791	2,1

The correction factors shown refer to water and glycol ethylene mixes used to prevent the formation of frost on the exchangers in the water circuit during inactivity in winter.

Fouling Correction Factors

m ² K/W	Internal exchanger	
	F1	FK1
0,44x10 ⁽⁻⁴⁾	-	-
0,88x10 ⁽⁻⁴⁾	0,96	0,99
1,76x10 ⁽⁻⁴⁾	0,93	0,98

The cooling performance values provided in the tables are based on the external exchanger having clean plates (fouling factor 1). For different fouling factor values, multiply the performance by the coefficients shown in the table.

F1 = Cooling capacity correction factors

FK1 = Compressor power input correction factor

Overload and control device calibrations

		Open	Close	Value
Refrigerant side				
High pressure safety switch	kPa	4200	3200	-
Low pressure safety switch	kPa	50	130	-
Low pressure safety valve	kPa	-	-	3000
Compressor discharge high temperature safety thermostat	°C	115	75	-
Water side				
Antifreeze protection	°C	4	20	-
High pressure safety valve	kPa	-	-	600*

* The value entered refers to units supplied with a hydronic group installed on board

Operating range - Cooling

Size 18.2 - 20.2 - 25.2 - 30.2 - 35.2

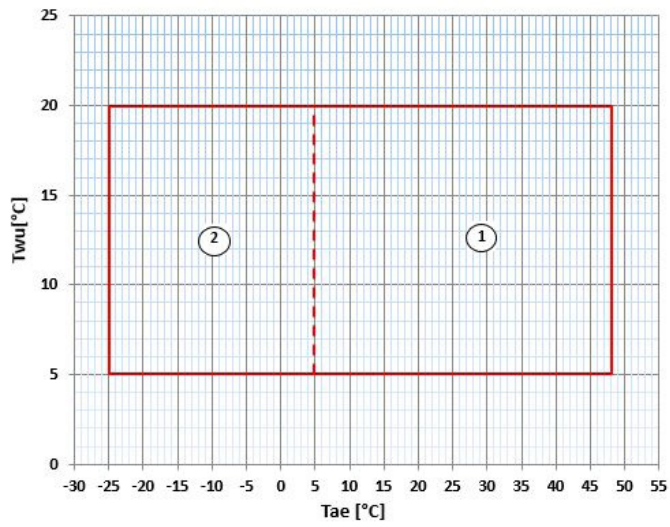

T_{wu} [°C] = Leaving exchanger water temperature
 T_{ae} [°C] = External exchanger inlet air temperature

1. Normal operating range
2. Operating range where the use of ethylene glycol is mandatory in relation to the temperature of the water at the outlet of the user side exchanger

Configuration

Standard unit

Entire hydraulic circuit of the unit pressure drop

Standard unit without hydronic assembly on the user side, but equipped with components as listed on the key of the enclosed plumbing circuit diagram.

It is possible to control an external pump by an on/off or 0-10V signal.
Water fittings are Victaulic type by 2".

Entire hydraulic circuit of the unit pressure drop curves

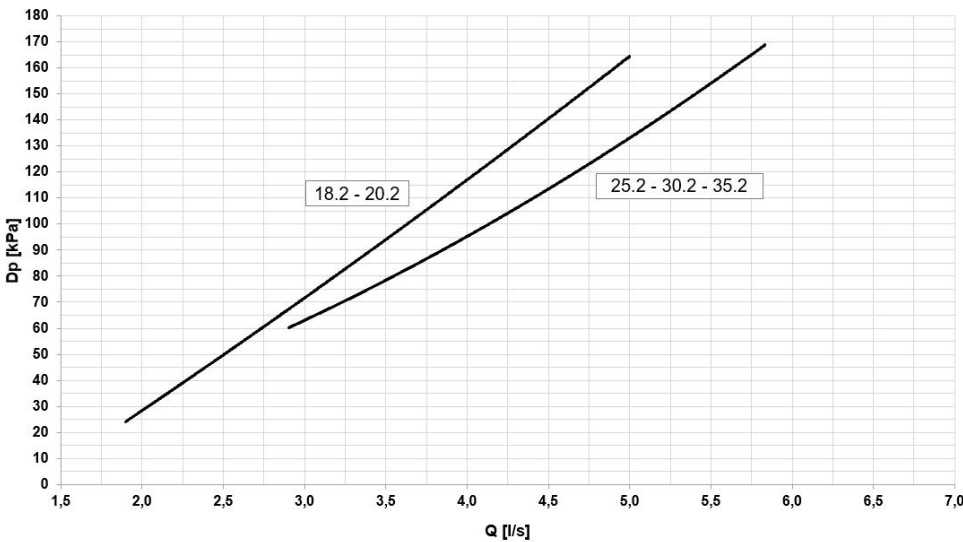

The pressure drops on the water side are calculated considering an average temperature of a mixture of water and ethylene glycol at 20% at 7 °C:

Q = Water flow rate [l/s]
DP = Pressure drops [kPa]

The water flow rate must be calculated with the following formula

$$Q \text{ [l/s]} = \frac{kWf}{4,186 \times DT}$$

kWf = Cooling capacity in kW
DT = Temperature difference between entering / leaving water

⚠ To the pressure drops (internal exchanger, pipes, 3-way valve, free-cooling coils) must be added the pressure drops of the steel mesh mechanical filter that must be placed on the water input line. It is a device compulsory for the correct unit operation, and it is provided by Clivet as accessory.

Admissible water flow rates

Min. (Qmin) and max. (Qmax) water flow-rates admissibles for the correct unit operation.

SIZE		18.2	20.2	25.2	30.2	35.2
Minimum flow-rate	[l/s]	1,9	1,9	2,9	2,9	2,9
Maximum flow-rate	[l/s]	6,4	6,4	6,4	6,4	6,4

Hydraulic diagram

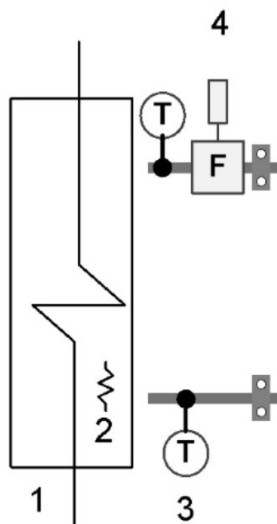

1. Exchanger
2. Anti-freeze resistance
3. Water temperature probe
4. Flow Switch

Hydronic assembly - Unit with 1 inverter pump (HYGU1V)

This configuration provides for one inverter-controlled electric centrifugal pump with body and impeller in AISI 304 steel and components listed in the key of the included water diagram. The electric pump is equipped with three-phase electric motor with IP55-protection and complete with thermoformed insulated casing.

During the installation phase it is possible to choose the most suitable head curve for system requirements by setting the inverter frequency.

The pump will always work at fixed flow.

Water fittings are Victaulic type by 2".

Pump available pressure curves size 18.2 - 20.2

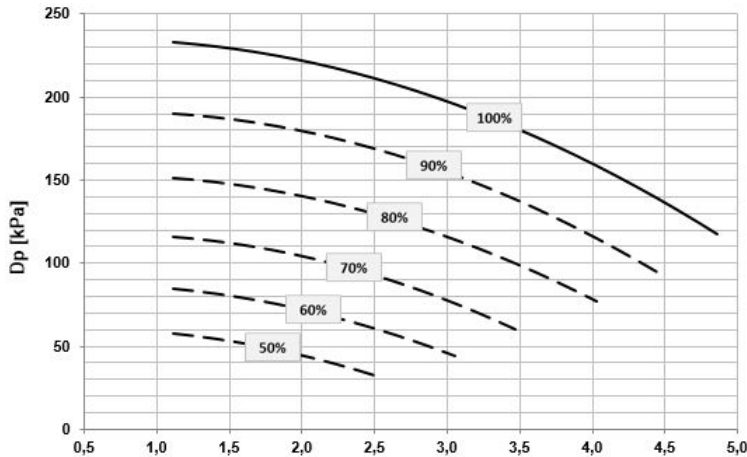

DP = Available pressure [kPa]
Q = Water flow-rate [l/s]

⚠ Caution: in order to obtain useful head values, the head represented in these diagrams must be lowered by:

- User side exchanger pressure drops
- IFWX - Steel mesh strainer on the water side" accessory (where present).

Pump absorption curves size 18.2 - 20.2

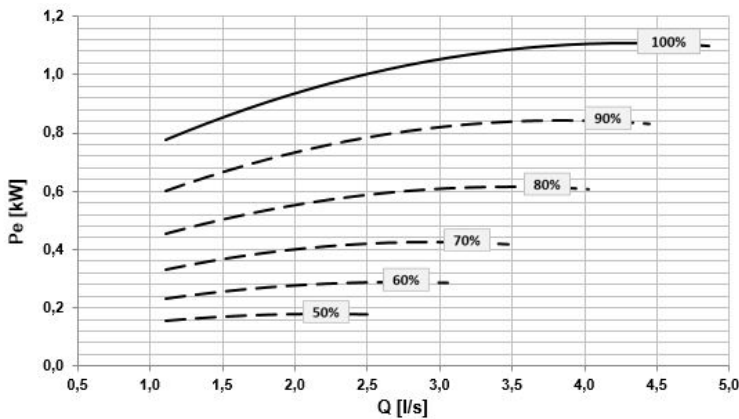

Pe = Power input [kW]
Q = Water flow-rate [l/s]

Hydraulic diagram

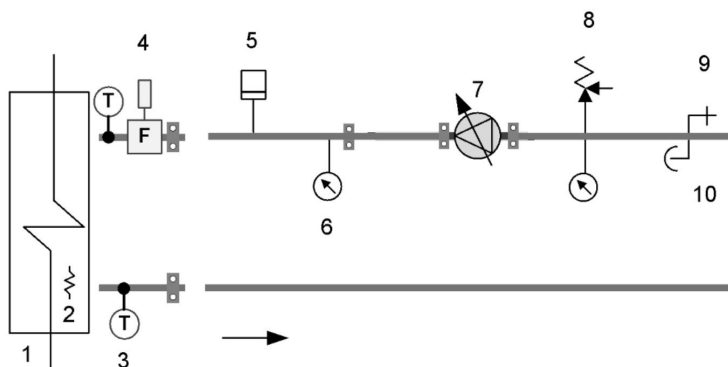

1. Exchanger
2. Antifreeze heater
3. Water temperature probe
4. Flow Switch
5. System load safety pressure switch
6. Pressure gauge
7. Inverter pump
8. Safety valve
9. Discharge
10. Vent

Configuration

Hydronic assembly - Unit with 1 inverter pump (HYGU1V)

Pump available pressure curves size 25.2 - 30.2 - 35.2

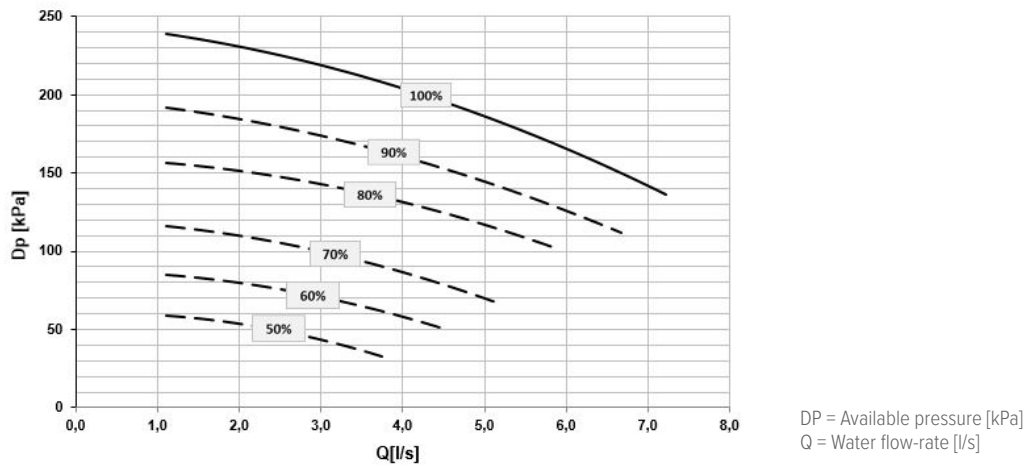

⚠ Caution: in order to obtain useful head values, the head represented in these diagrams must be lowered by:

- User side exchanger pressure drops
- IFWX - Steel mesh strainer on the water side” accessory (where present).

Pump available pressure curves size 25.2 - 30.2 - 35.2

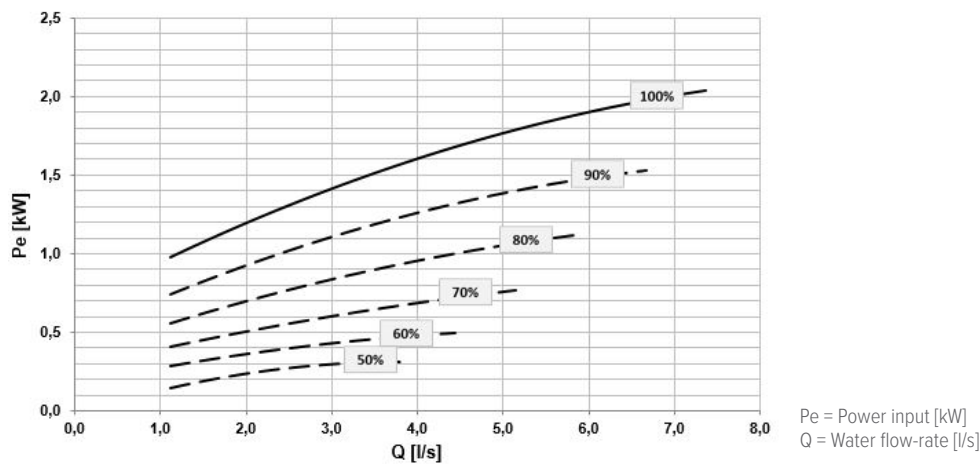

Electrical data

SIZE		18.2	20.2	25.2	30.2	35.2
F.L.A.	A	1,90	1,90	2,50	2,50	2,50
F.L.I.	kW	0,75	0,75	1,1	1,1	1,1

FCD - Direct FREE-COOLING

Configuration that allows for considerable savings on the system's running costs in applications that require chilled water also during the cold season, such as industrial processes, data centres, telecommunications, technological applications and shopping centres. When the outdoor air temperature is lower than the temperature of the system's return water, the FREE-COOLING system recovers cold from the external environment and reduces the operation of the compressors until they stop completely. The higher the temperature of the chilled water in the system (e.g. 10-15°C instead of 7-12°C), the greater the operating range of the FREE-COOLING system and, therefore, the higher the energy savings.

Use of anti-freeze solutions

The FREE-COOLING configuration is particularly indicated in buildings where, at least in certain periods of the year, the temperature of the outdoor air also reaches very low values. For this reason the liquid must be protected from the risk of freezing, typically using the addition of a suitable anti-freeze substance such as ethylene glycol. The percentage of glycol in the solution depends on the minimum temperature value foreseen in the installation zone, and is in any case within the fundamental parameters of the plan for the system.

Management logic

There are three main operating modes, which basically differ in terms of position of the three-way switching valve and the number of active compressors.

(A) Summer

In the summer season, with outdoor air temperatures which are greater than the return temperature of the liquid in the system, the three-way valve is switched in such a way as to exclude the FREE-COOLING coils. The cooling of the liquid is referred to the direct expansion circuit, with the intervention of the compressors as in a traditional chiller.

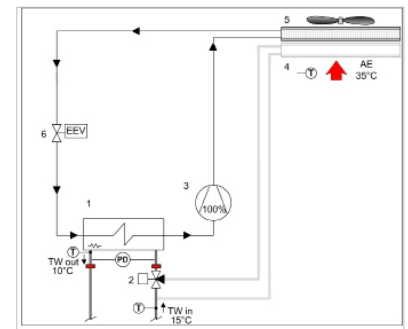

(B) Intermediate season

In the winter season, or rather with the outdoor air temperature at a little below the return water temperature of the system, when the unit identifies that the temperature conditions are favourable:

- switches the position of the three-way valve, forcing the solution to transit through the FREE-COOLING coils before reaching the evaporator;
- brings the fans to maximum speed to make the most of the cooling of the solution carried out by the outdoor air
- conducts a first cooling of the solution in a 'natural way and free of charge';
- provides any missing capacity via the cooling circuit using compressors with partial operation (power input proportional to the partialisation level).

If the outdoor air temperature should increase, the microprocessor automatically converts the operating mode to the summer mode, guaranteeing the conditions requested by the user at all times.

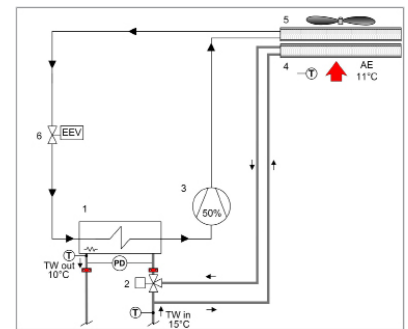

(C) Winter

In the winter season, with the outdoor air temperature below the return water temperature of the system, the unit identifies that the temperature conditions are favourable for operating in FREE-COOLING mode:

- the 3-way valve is switched like in the previous case, forcing the solution to transit through the FREE-COOLING coils before reaching the evaporator;
- the outdoor air temperature brings the solution at the outlet of the FREE-COOLING coils already at the temperature required by the utility;
- the microprocessor control completely deactivates all the compressors which supply all the requested cooling capacity at no cost, in contrast to traditional chillers.

The difference between the outdoor air temperature and that requested for use could also be such as to lower the temperature of the solution at the output of the FREE-COOLING coils to below the set-point requested for use. This is a condition which does not prejudice the safety of the unit thanks to the presence of anti-freeze in the solution. The microprocessor modulates fan speed up to the point where they are switched off. If, with all the fans switched, off the temperature continues to decrease, the three-way valve positions itself automatically in the summer operational mode, thus enabling the requested set-point to be maintained.

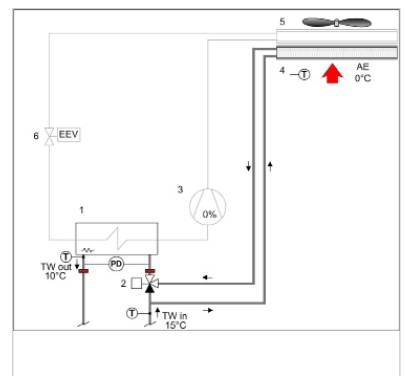

- 1 - Internal exchanger
- 2 - Three-way valve for FREE-COOLING
- 3 - Compressors
- 4 - External exchanger
- 5 - External fan
- 6 - Expansion electronic valve
- T - Temperature probe
- TW in chilled water inlet
- TW out chilled water outlet
- AE - Outdoor air
- PD - Differential pressure switch

Configuration

Determination of the direct FREE-COOLING percentage

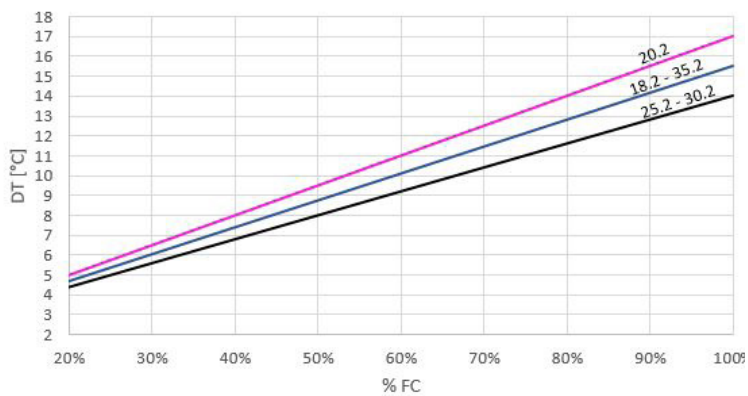

DT [°C] = Temperature difference between the system return water and the outdoor air

% FC = FREE-COOLING percentage (in relation to the rated FREE-COOLING capacity)

SIZE		18.2	20.2	25.2	30.2	35.2
FREE-COOLING (1) nominal capacity	kW	64,5	71,8	86,5	92,3	103
Air temperature with FREE-COOLING at 100% (1)	°C	-0,1	1,0	1,6	-1,9	-0,8

(1) Data refer to the following conditions:
 - water temperature: 15°C inlet / 10°C outlet
 - glycol percentage 30%

Cooling - Size 18.2

To	Tae	Cooling capacity EN14511								EER EN14511							
		Percentage of compressor load								Percentage of compressor load							
		°C	100%	90%	80%	70%	60%	50%	40%	min%	100%	90%	80%	70%	60%	50%	40%
5	10	60,4	53,7	50,6	42,7	36,8	31,6	25,2	21,3	5,87	5,91	6,15	6,27	6,36	6,70	7,07	7,24
	15	57,8	51,4	48,4	40,9	35,1	30,1	23,9	20,2	4,99	5,06	5,26	5,37	5,46	5,75	6,00	6,06
	25	52,5	46,7	44,0	37,0	31,7	27,1	21,3	17,7	3,66	3,75	3,87	3,96	4,01	4,18	4,24	4,16
	35	47,1	41,9	39,4	33,1	28,2	23,9	18,5	15,2	2,71	2,81	2,87	2,92	2,93	3,01	2,95	2,80
	45	41,5	36,9	34,7	29,0	24,6	20,6	15,6	12,6	2,02	2,06	2,11	2,14	2,12	2,13	2,00	1,83
7	10	64,4	57,3	54,0	45,6	39,2	33,6	26,8	22,6	6,27	6,31	6,56	6,66	6,77	7,15	7,53	7,73
	15	61,7	54,9	51,7	43,6	37,5	32,1	25,4	21,4	5,32	5,38	5,59	5,69	5,79	6,11	6,38	6,45
	25	56,2	50,0	47,1	39,6	33,9	28,9	22,6	18,8	3,88	3,97	4,10	4,17	4,24	4,42	4,49	4,41
	35	50,4	44,9	42,2	35,4	30,1	25,5	19,7	16,2	2,83	2,96	3,02	3,07	3,09	3,17	3,11	2,95
	45	44,5	39,6	37,2	31,0	26,2	22,0	16,6	13,3	2,13	2,17	2,23	2,25	2,23	2,24	2,11	1,92
10	10	70,8	62,9	59,3	50,0	42,9	36,8	29,1	24,5	6,91	6,93	7,20	7,27	7,42	7,88	8,34	8,57
	15	67,9	60,4	56,9	47,9	41,1	35,1	27,7	23,3	5,82	5,88	6,11	6,19	6,31	6,69	7,01	7,11
	25	61,9	55,1	51,8	43,5	37,2	31,6	24,7	20,5	4,22	4,31	4,45	4,51	4,59	4,80	4,89	4,80
	35	55,7	49,5	46,5	38,9	33,1	28,0	21,5	17,6	3,11	3,20	3,27	3,31	3,33	3,42	3,36	3,18
	45	49,2	43,8	41,0	34,1	28,8	24,1	18,1	14,4	2,30	2,34	2,40	2,41	2,39	2,41	2,26	2,05
15	10	82,0	73,0	68,6	57,6	49,4	42,2	33,2	27,8	8,04	8,07	8,37	8,38	8,60	9,25	9,95	10,34
	15	78,8	70,1	65,8	55,2	47,3	40,3	31,6	26,4	6,73	6,78	7,04	7,08	7,26	7,76	8,24	8,44
	25	72,0	64,0	60,1	50,2	42,8	36,4	28,2	23,3	4,82	4,91	5,06	5,10	5,20	5,48	5,62	5,56
	35	64,9	57,6	54,0	44,9	38,1	32,1	24,6	20,0	3,53	3,62	3,69	3,71	3,74	3,86	3,81	3,62
	45	57,3	50,9	47,5	39,3	33,0	27,5	20,6	16,3	2,60	2,63	2,70	2,69	2,67	2,70	2,53	2,30
18	10	89,2	79,3	74,4	62,4	53,4	45,5	35,8	29,9	8,77	8,81	9,12	9,10	9,38	10,18	11,12	11,70
	15	85,7	76,1	71,4	59,8	51,1	43,5	34,1	28,3	7,29	7,37	7,63	7,64	7,87	8,48	9,13	9,44
	25	78,4	69,6	65,2	54,4	46,3	39,2	30,4	25,0	5,20	5,29	5,45	5,47	5,59	5,93	6,14	6,09
	35	70,6	62,7	58,6	48,6	41,1	34,6	26,4	21,4	3,79	3,88	4,00	4,02	4,09	4,15	4,11	3,91
	45	62,4	55,3	51,5	42,4	35,6	29,7	22,1	17,5	2,78	2,82	2,88	2,86	2,85	2,88	2,71	2,46
20	10	94,1	83,5	78,4	65,6	56,0	47,8	37,5	31,2	9,28	9,31	9,64	9,59	9,94	10,89	12,06	12,81
	15	90,4	80,2	75,2	62,9	53,7	45,7	35,7	29,7	7,70	7,76	8,03	8,03	8,29	9,01	9,80	10,22
	25	82,6	73,4	68,7	57,2	48,6	41,2	31,8	26,2	5,46	5,55	5,71	5,72	5,87	6,24	6,50	6,50
	35	74,5	66,1	61,6	51,1	43,2	36,3	27,6	22,4	3,97	4,05	4,14	4,13	4,18	4,35	4,32	4,13
	45	65,8	58,3	54,2	44,5	37,3	31,1	23,1	18,2	2,91	2,94	3,01	2,98	2,96	3,01	2,84	2,58

To = Leaving internal exchanger water temperature (°C)

Tae [°C]= External exchanger inlet air temperature

Performances in function of the inlet/outlet water temperature differential = 5°C

Cooling capacity and EER calculated according to EN 14511:2018

Performances

Cooling - Size - Grandezza 20.2

To	Tae	Cooling capacity EN14511								EER EN14511							
		Percentage of compressor load								Percentage of compressor load							
°C	°C	100%	90%	80%	70%	60%	50%	40%	min%	100%	90%	80%	70%	60%	50%	40%	min%
5	10	67,6	58,5	53,7	47,4	40,8	35,1	28,0	21,3	5,79	5,82	5,88	6,02	6,19	6,48	6,93	7,24
	15	64,6	56,0	51,4	45,3	39,0	33,5	26,6	20,2	4,89	4,93	5,01	5,15	5,32	5,56	5,90	6,06
	25	58,6	50,9	46,7	41,2	35,3	30,2	23,8	17,7	3,56	3,59	3,69	3,79	3,92	4,07	4,24	4,16
	35	52,4	45,6	41,9	36,9	31,5	26,8	20,9	15,2	2,63	2,67	2,74	2,80	2,89	2,97	3,00	2,80
	45	46,1	40,2	36,9	32,4	27,5	23,3	17,8	12,6	1,95	2,00	2,03	2,07	2,11	2,14	2,09	1,83
7	10	72,1	62,4	57,3	50,5	43,5	37,4	29,8	22,6	6,17	6,22	6,27	6,42	6,57	6,90	7,39	7,73
	15	69,0	59,8	54,9	48,4	41,6	35,7	28,3	21,4	5,20	5,22	5,34	5,47	5,63	5,91	6,28	6,45
	25	62,7	54,4	49,9	44,0	37,7	32,3	25,4	18,8	3,77	3,80	3,91	4,01	4,14	4,31	4,49	4,41
	35	56,2	48,9	44,9	39,5	33,6	28,6	22,3	16,2	2,66	2,82	2,89	2,96	3,04	3,12	3,16	2,95
	45	49,4	43,1	39,6	34,7	29,4	24,9	19,0	13,3	2,06	2,10	2,14	2,18	2,22	2,24	2,19	1,92
10	10	79,1	68,6	62,9	55,5	47,7	40,9	32,5	24,5	6,78	6,83	6,90	7,04	7,17	7,57	8,15	8,57
	15	75,8	65,8	60,3	53,2	45,6	39,1	31,0	23,3	5,68	5,69	5,84	5,97	6,11	6,45	6,90	7,11
	25	69,0	60,0	55,0	48,5	41,4	35,4	27,8	20,5	4,09	4,14	4,25	4,35	4,46	4,66	4,88	4,80
	35	62,0	54,0	49,5	43,5	36,9	31,4	24,3	17,6	3,00	3,05	3,13	3,20	3,27	3,37	3,42	3,18
	45	54,7	47,7	43,7	38,3	32,3	27,2	20,7	14,4	2,22	2,23	2,31	2,34	2,38	2,41	2,35	2,05
15	10	91,7	79,5	72,9	64,2	54,9	47,0	37,2	27,8	7,84	7,78	8,04	8,17	8,23	8,81	9,67	10,34
	15	88,0	76,4	70,0	61,6	52,6	45,0	35,4	26,4	6,52	6,51	6,75	6,87	6,96	7,43	8,05	8,44
	25	80,3	69,8	64,0	56,2	47,7	40,7	31,8	23,3	4,65	4,67	4,85	4,94	5,03	5,30	5,60	5,56
	35	72,2	62,9	57,6	50,4	42,6	36,2	27,9	20,0	3,40	3,41	3,55	3,60	3,65	3,79	3,87	3,62
	45	63,8	55,6	50,8	44,3	37,1	31,3	23,6	16,3	2,50	2,51	2,61	2,63	2,65	2,69	2,64	2,30
18	10	99,8	86,5	79,2	69,6	59,3	50,8	40,0	29,9	8,52	8,54	8,78	8,89	8,90	9,65	10,72	11,70
	15	95,7	83,0	76,1	66,8	56,9	48,6	38,2	28,3	7,06	7,11	7,32	7,45	7,50	8,09	8,88	9,44
	25	87,4	76,0	69,5	60,9	51,6	44,0	34,3	25,0	5,01	5,04	5,23	5,32	5,38	5,72	6,08	6,09
	35	78,7	68,5	62,6	54,7	46,0	39,0	30,0	21,4	3,65	3,69	3,81	3,86	3,90	4,06	4,17	3,91
	45	69,4	60,5	55,2	48,0	40,0	33,7	25,4	17,5	2,68	2,69	2,79	2,81	2,81	2,87	2,82	2,46
20	10	105,3	91,2	83,4	73,3	62,4	53,3	42,0	31,2	8,99	9,03	9,27	9,40	9,38	10,24	11,55	12,81
	15	101,0	87,6	80,2	70,3	59,7	51,0	40,1	29,7	7,42	7,45	7,72	7,84	7,87	8,54	9,48	10,22
	25	92,2	80,1	73,3	64,1	54,2	46,2	35,9	26,2	5,25	5,28	5,50	5,58	5,62	6,01	6,44	6,50
	35	82,9	72,2	66,0	57,5	48,3	41,0	31,5	22,4	3,81	3,84	3,99	4,04	4,06	4,25	4,38	4,13
	45	73,3	63,8	58,2	50,5	42,0	35,3	26,6	18,2	2,80	2,82	2,92	2,93	2,92	2,99	2,95	2,58

To = Leaving internal exchanger water temperature (°C)

Tae [°C]= External exchanger inlet air temperature

Performances in function of the inlet/outlet water temperature differential = 5°C

Cooling capacity and EER calculated according to EN 14511:2018

Cooling - Size 25.2

To	Tae	Cooling capacity EN14511								EER EN14511							
		Percentage of compressor load								Percentage of compressor load							
		°C	100%	90%	80%	70%	60%	50%	40%	min%	100%	90%	80%	70%	60%	50%	40%
5	10	77,7	69,2	62,3	55,5	48,1	42,1	35,0	32,1	5,25	5,34	5,64	5,70	5,77	5,89	5,94	5,81
	15	75,2	66,8	60,1	53,5	46,2	40,3	33,3	30,4	4,72	4,83	5,16	5,27	5,40	5,56	5,63	5,54
	25	69,8	62,0	55,7	49,4	42,4	36,6	29,7	26,8	3,69	3,81	4,12	4,24	4,37	4,49	4,47	4,38
	35	64,4	57,2	51,2	45,2	38,5	32,9	26,1	23,2	2,80	2,89	3,13	3,21	3,27	3,28	3,11	2,98
	45	58,9	52,2	46,6	41,0	34,6	29,1	22,5	19,6	2,10	2,15	2,31	2,34	2,34	2,26	2,01	1,86
7	10	82,4	73,3	66,0	58,8	50,9	44,4	36,8	33,7	5,53	5,62	5,95	6,02	6,10	6,22	6,26	6,12
	15	79,6	70,9	63,7	56,6	48,9	42,5	34,9	31,8	4,96	5,08	5,44	5,56	5,70	5,86	5,91	5,82
	25	74,1	65,8	59,0	52,3	44,9	38,6	31,2	28,1	3,88	4,00	4,34	4,46	4,61	4,72	4,68	4,59
	35	68,6	60,7	54,3	48,0	40,8	34,8	27,5	24,5	2,85	3,05	3,30	3,39	3,45	3,46	3,27	3,13
	45	62,7	55,6	49,6	43,6	36,8	31,0	23,8	20,8	2,21	2,28	2,45	2,48	2,47	2,39	2,12	1,96
10	10	89,8	79,8	71,8	63,9	55,2	48,0	39,6	36,1	5,94	6,05	6,44	6,53	6,62	6,76	6,79	6,63
	15	86,8	77,1	69,3	61,5	53,0	46,0	37,6	34,1	5,32	5,47	5,87	6,01	6,16	6,34	6,39	6,28
	25	80,7	71,8	64,3	56,9	48,8	41,9	33,7	30,2	4,16	4,31	4,68	4,82	4,98	5,10	5,04	4,93
	35	74,8	66,4	59,4	52,4	44,5	37,9	29,8	26,4	3,18	3,29	3,57	3,67	3,74	3,74	3,52	3,37
	45	68,7	61,0	54,5	47,9	40,4	34,0	26,1	22,7	2,40	2,47	2,66	2,70	2,70	2,61	2,31	2,13
15	10	103,1	91,6	82,2	73,0	63,0	54,6	44,7	40,6	6,65	6,82	7,30	7,45	7,61	7,81	7,85	7,68
	15	99,7	88,5	79,4	70,5	60,6	52,3	42,5	38,4	5,97	6,16	6,66	6,86	7,07	7,30	7,36	7,24
	25	93,0	82,6	73,9	65,4	55,9	47,9	38,2	34,2	4,69	4,87	5,31	5,51	5,70	5,85	5,77	5,65
	35	86,4	76,7	68,7	60,5	51,4	43,6	34,2	30,2	3,61	3,75	4,08	4,20	4,30	4,31	4,04	3,87
	45	79,9	71,1	63,5	55,8	47,1	39,5	30,3	26,3	2,75	2,84	3,07	3,13	3,13	3,03	2,68	2,48
18	10	111,8	99,3	89,1	79,1	68,1	58,9	48,0	43,5	7,11	7,33	7,89	8,09	8,33	8,58	8,67	8,49
	15	108,2	96,1	86,1	76,3	65,6	56,5	45,7	41,3	6,39	6,63	7,20	7,44	7,73	8,01	8,11	7,99
	25	101,1	89,8	80,4	71,1	60,7	51,9	41,3	36,9	5,05	5,26	5,76	5,99	6,23	6,41	6,34	6,21
	35	94,2	83,7	74,8	66,0	56,0	47,5	37,1	32,7	3,91	4,14	4,44	4,59	4,71	4,73	4,44	4,25
	45	87,5	77,7	69,6	61,2	51,6	43,4	33,2	28,9	3,00	3,10	3,36	3,43	3,44	3,34	2,95	2,74
20	10	117,8	104,7	93,9	83,3	71,7	62,0	50,4	45,6	7,43	7,69	8,32	8,57	8,86	9,17	9,34	9,16
	15	114,1	101,3	90,9	80,5	69,1	59,5	48,0	43,3	6,70	6,97	7,61	7,89	8,22	8,56	8,71	8,59
	25	106,8	94,9	84,9	75,0	64,1	54,7	43,5	38,8	5,31	5,55	6,10	6,35	6,63	6,85	6,79	6,66
	35	99,8	88,6	79,2	69,9	59,3	50,3	39,3	34,6	4,13	4,31	4,71	4,89	5,03	5,06	4,75	4,55
	45	92,9	82,6	73,8	65,0	54,8	46,1	35,3	30,7	3,19	3,30	3,58	3,67	3,69	3,58	3,16	2,94

To = Leaving internal exchanger water temperature (°C)

Tae [°C]= External exchanger inlet air temperature

Performances in function of the inlet/outlet water temperature differential = 5°C

Cooling capacity and EER calculated according to EN 14511:2018

Performances

Cooling - Size 30.2

To	Tae	Cooling capacity EN14511								EER EN14511							
		Percentage of compressor load								Percentage of compressor load							
		°C	100%	90%	80%	70%	60%	50%	40%	min%	100%	90%	80%	70%	60%	50%	40%
5	10	83,4	74,1	68,0	58,9	51,3	44,1	37,1	32,1	5,33	5,36	5,57	5,68	5,74	5,84	5,98	5,81
	15	80,6	71,7	65,6	56,8	49,3	42,2	35,3	30,4	4,75	4,84	5,06	5,22	5,34	5,49	5,68	5,54
	25	75,1	66,7	60,9	52,5	45,4	38,5	31,7	26,8	3,69	3,71	4,00	4,18	4,32	4,45	4,55	4,38
	35	69,2	61,5	56,1	48,2	41,4	34,7	28,1	23,2	2,80	2,82	3,04	3,18	3,26	3,29	3,22	2,98
	45	63,3	56,2	51,2	43,8	37,3	31,0	24,5	19,6	2,10	2,11	2,26	2,33	2,35	2,30	2,13	1,86
7	10	88,5	78,7	72,1	62,4	54,2	46,5	39,0	33,7	5,60	5,64	5,88	5,99	6,06	6,17	6,30	6,12
	15	85,6	76,0	69,6	60,2	52,2	44,6	37,2	31,8	4,99	5,03	5,33	5,51	5,64	5,80	5,97	5,82
	25	79,6	70,7	64,6	55,7	48,0	40,7	33,4	28,1	3,87	3,90	4,21	4,41	4,55	4,69	4,78	4,59
	35	73,6	65,3	59,6	51,2	43,9	36,8	29,7	24,5	2,84	3,06	3,21	3,35	3,43	3,47	3,39	3,13
	45	67,3	59,8	54,5	46,7	39,8	32,9	26,0	20,8	2,22	2,22	2,39	2,47	2,49	2,44	2,25	1,96
10	10	96,5	85,7	78,4	67,9	58,9	50,4	42,1	36,1	6,00	6,05	6,33	6,49	6,58	6,70	6,84	6,63
	15	93,3	82,8	75,7	65,5	56,7	48,3	40,1	34,1	5,35	5,40	5,73	5,95	6,10	6,28	6,46	6,28
	25	86,8	77,0	70,5	60,7	52,3	44,2	36,1	30,2	4,15	4,19	4,54	4,76	4,92	5,07	5,14	4,93
	35	80,3	71,4	65,1	55,9	47,9	40,1	32,2	26,4	3,17	3,20	3,46	3,63	3,72	3,76	3,66	3,37
	45	73,8	65,6	59,8	51,2	43,6	36,1	28,4	22,7	2,40	2,41	2,59	2,69	2,71	2,66	2,45	2,13
15	10	110,9	98,4	89,9	77,7	67,3	57,4	47,6	40,6	6,69	6,73	7,15	7,39	7,55	7,73	7,92	7,68
	15	107,2	95,1	86,9	75,0	64,8	55,0	45,4	38,4	5,97	6,00	6,48	6,76	6,98	7,22	7,45	7,24
	25	100,0	88,7	81,0	69,8	60,0	50,5	41,1	34,2	4,66	4,72	5,13	5,42	5,63	5,81	5,91	5,65
	35	92,8	82,5	75,3	64,7	55,3	46,2	37,0	30,2	3,59	3,63	3,94	4,15	4,27	4,33	4,21	3,87
	45	85,7	76,3	69,7	59,7	50,9	42,1	33,1	26,3	2,74	2,76	2,99	3,11	3,14	3,09	2,85	2,48
18	10	120,2	106,7	97,5	84,1	72,8	62,0	51,3	43,5	7,12	7,15	7,70	8,00	8,21	8,48	8,74	8,49
	15	116,3	103,2	94,3	81,3	70,2	59,5	48,9	41,3	6,36	6,43	6,97	7,33	7,61	7,91	8,20	7,99
	25	108,7	96,5	88,1	75,8	65,2	54,8	44,4	36,9	5,01	5,09	5,55	5,88	6,14	6,37	6,49	6,21
	35	101,2	89,8	82,1	70,5	60,3	50,3	40,2	32,7	3,88	3,99	4,29	4,53	4,67	4,75	4,63	4,25
	45	93,8	83,5	76,3	65,4	55,7	46,1	36,2	28,9	2,99	3,02	3,26	3,41	3,46	3,40	3,14	2,74
20	10	126,7	112,4	102,8	88,7	76,7	65,2	53,8	45,6	7,41	7,48	8,08	8,46	8,73	9,06	9,39	9,16
	15	122,7	108,9	99,5	85,7	73,9	62,7	51,4	43,3	6,65	6,74	7,34	7,75	8,07	8,45	8,81	8,59
	25	114,8	102,0	93,1	80,0	68,8	57,8	46,8	38,8	5,26	5,35	5,86	6,23	6,53	6,80	6,94	6,66
	35	107,2	95,2	86,9	74,6	63,9	53,3	42,5	34,6	4,10	4,16	4,55	4,81	4,98	5,07	4,96	4,55
	45	99,6	88,7	81,0	69,5	59,2	49,0	38,5	30,7	3,17	3,21	3,48	3,64	3,70	3,65	3,37	2,94

To = Leaving internal exchanger water temperature (°C)

Tae [°C]= External exchanger inlet air temperature

Performances in function of the inlet/outlet water temperature differential = 5°C

Cooling capacity and EER calculated according to EN 14511:2018

Cooling - Size 35.2

To	Tae	Cooling capacity EN14511								EER EN14511							
		Percentage of compressor load								Percentage of compressor load							
		°C	100%	90%	80%	70%	60%	50%	40%	min%	100%	90%	80%	70%	60%	50%	40%
5	10	91,8	85,0	74,0	64,5	55,6	48,1	40,1	32,1	5,27	5,32	5,49	5,62	5,70	5,78	5,95	5,81
	15	88,7	82,2	71,5	62,3	53,5	46,2	38,3	30,4	4,67	4,78	4,95	5,13	5,28	5,40	5,62	5,54
	25	82,4	76,5	66,4	57,7	49,4	42,4	34,7	26,8	3,60	3,77	3,89	4,07	4,24	4,37	4,53	4,38
	35	76,1	70,6	61,2	53,1	45,2	38,5	31,0	23,2	2,74	2,87	2,95	3,10	3,21	3,27	3,27	2,98
	45	69,5	64,5	55,9	48,4	41,0	34,6	27,3	19,6	2,06	2,10	2,20	2,29	2,35	2,33	2,22	1,86
7	10	97,5	90,2	78,3	68,4	58,8	50,9	42,3	33,7	5,54	5,58	5,77	5,92	6,02	6,11	6,28	6,12
	15	94,2	87,2	75,7	66,0	56,7	48,9	40,4	31,8	4,90	5,00	5,20	5,40	5,56	5,70	5,92	5,82
	25	87,5	81,1	70,4	61,3	52,4	44,8	36,6	28,1	3,78	3,89	4,09	4,29	4,47	4,60	4,76	4,59
	35	80,8	75,0	65,0	56,4	48,0	40,8	32,8	24,5	2,75	2,92	3,11	3,26	3,39	3,45	3,45	3,13
	45	74,0	68,7	59,5	51,6	43,7	36,8	29,0	20,8	2,17	2,21	2,33	2,42	2,48	2,47	2,35	1,96
10	10	106,3	98,4	85,4	74,4	63,9	55,2	45,7	36,1	5,92	5,96	6,21	6,39	6,53	6,63	6,81	6,63
	15	102,7	95,0	82,5	71,9	61,6	53,0	43,6	34,1	5,24	5,30	5,59	5,82	6,01	6,17	6,41	6,28
	25	95,5	88,4	76,7	66,8	57,0	48,7	39,6	30,2	4,05	4,17	4,39	4,62	4,83	4,98	5,14	4,93
	35	88,3	81,8	71,1	61,7	52,4	44,5	35,6	26,4	3,09	3,13	3,35	3,53	3,67	3,74	3,73	3,37
	45	80,9	75,3	65,3	56,6	47,9	40,4	31,8	22,7	2,34	2,39	2,52	2,63	2,70	2,69	2,56	2,13
15	10	122,1	112,9	98,0	85,3	73,1	63,0	51,8	40,6	6,56	6,87	6,99	7,24	7,45	7,62	7,88	7,68
	15	118,0	109,2	94,7	82,4	70,6	60,6	49,6	38,4	5,83	6,00	6,29	6,59	6,87	7,08	7,38	7,24
	25	110,0	101,9	88,4	76,8	65,5	55,9	45,2	34,2	4,54	4,66	4,95	5,24	5,51	5,70	5,89	5,65
	35	102,0	94,6	82,1	71,3	60,6	51,4	41,0	30,2	3,50	3,54	3,81	4,03	4,21	4,30	4,29	3,87
	45	94,1	87,5	76,0	66,0	55,9	47,1	37,0	26,3	2,68	2,72	2,89	3,04	3,13	3,12	2,97	2,48
18	10	132,4	122,4	106,2	92,4	79,2	68,1	55,9	43,5	6,96	7,00	7,48	7,82	8,10	8,33	8,67	8,49
	15	128,1	118,5	102,8	89,4	76,4	65,6	53,5	41,3	6,20	6,29	6,75	7,11	7,45	7,74	8,11	7,99
	25	119,6	110,8	96,1	83,4	71,2	60,7	48,9	36,9	4,86	4,99	5,34	5,68	6,00	6,23	6,47	6,21
	35	111,2	102,6	89,5	77,7	66,1	56,0	44,6	32,7	3,68	3,74	4,13	4,38	4,60	4,71	4,71	4,25
	45	102,9	95,7	83,2	72,3	61,2	51,6	40,5	28,9	2,92	2,96	3,16	3,33	3,44	3,44	3,28	2,74
20	10	139,6	129,1	112,0	97,4	83,4	71,7	58,8	45,6	7,23	7,29	7,83	8,23	8,58	8,86	9,29	9,16
	15	135,1	125,0	108,4	94,3	80,6	69,1	56,3	43,3	6,46	6,57	7,08	7,50	7,90	8,23	8,68	8,59
	25	126,3	117,0	101,5	88,2	75,1	64,0	51,6	38,8	5,10	5,14	5,63	6,00	6,36	6,64	6,92	6,66
	35	117,7	109,3	94,8	82,3	70,0	59,3	47,2	34,6	3,98	4,03	4,37	4,65	4,89	5,02	5,04	4,55
	45	109,2	101,6	88,4	76,7	65,1	54,8	43,1	30,7	3,09	3,14	3,36	3,54	3,67	3,68	3,52	2,94

To = Leaving internal exchanger water temperature (°C)

Tae [°C]= External exchanger inlet air temperature

Performances in function of the inlet/outlet water temperature differential = 5°C

Cooling capacity and EER calculated according to EN 14511:2018

Modularity

Modular system configuration

- Management of the entire system takes place through a unit defined as master. The master unit controller can be set up remotely at a maximum distance of up to 300 m.
- All units must be connected to each other using a shielded cable with three wires (3 x 0.75 mm²).
- Each module must be configured with the water connections for modular unit (AMODX).
- Each module can be equipped with inertial system storage tank (ACIMP).
- It's possible to select a built-in hydronic group. In this case, all units have to be of the same module (module 1: sizes 18.2-20.2, module 2: sizes 25.2-30.2-35.2) and with the same options. The presence of system tank or 3-way valve generates pressure drops which lead to imbalances in the hydraulic circuit. Special precautions to be taken:
 - The units has to be hydraulically connected at the same distance from each other using AMODX and CCKMUX accessories. The AMODX accessory selected with pump on board will be equipped with a non-return valve that avoids recirculation in the single unit.
 - Being a primary circuit with variable flow, if in the presence of a secondary one, the system requires a hydraulic circuit breaker. Alternatively, it can be equipped with inlet and outlet manifolds with bypass to compensate possible flow unbalances.
 - Check that each pump works within the allowed flow rate limits even when only one unit is ON and the others are OFF.

For different configurations, please contact Clivet Technical Office.

- It is possible to foresee an external pumping unit, sized for the entire capacity of the modular system (responsibility of the Customer). Pumping unit management will take place from the Master unit through a potential free contact and 0-10V signal.
- It is necessary to install a Y filter on the water input of the entire modular system (customer responsibility) with the following characteristics: MESH equal to 30 (0.5 mm)
- it's possible to connect in parallel chiller units (WSAT-YES) and free-cooling units (WSAT-YES FC). These series cannot be connected in parallel with heat pump units (WSAN-YES).

Every module is identified by a specific address.

Complete system management is carried out by the master unit, identified by the address 0.

Thermoregulation takes place on the supply temperature of the entire defined system (Tw)

If $T_w \geq \text{set point} + 10^\circ\text{C}$:

the regulation activates 50% of the resources in sequence based on the defined address. Once a time interval has passed (default: 240 seconds), if the load increases, further resources are activated, if the load decreases, the units are shutoff with the sequence (first start, first stop).

If $T_w < \text{set point} + 10^\circ\text{C}$:

The adjustment on activates the master unit. Once a time interval has passed (default: 240 seconds), if the load increases, in sequence further resources will activate based on the defined address, if the load decreases the master unit will shut-off.

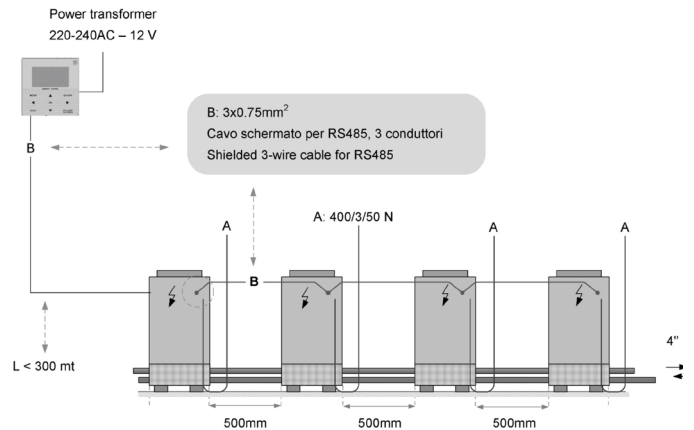

Modular system connection diagram

- Clearance values
- Power supply
- Connection

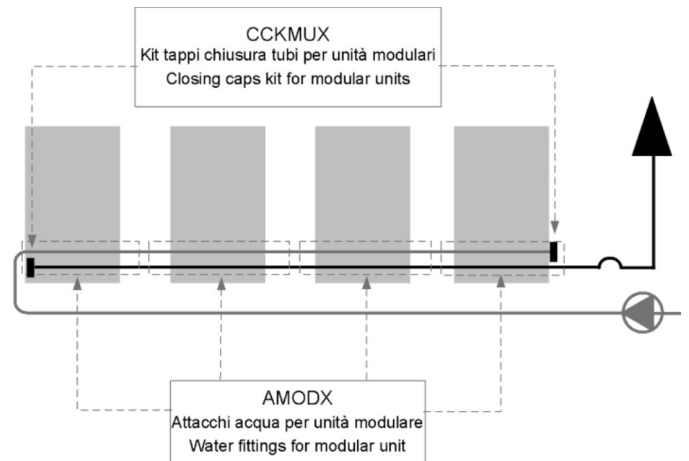

Options for modular system connection:

- AMODX - Water fitting for modular unit
- CCKMUX - Closing caps kit

Size 18.2 - 20.2

DAASC0001_REV01
Data/Date 02/04/20201

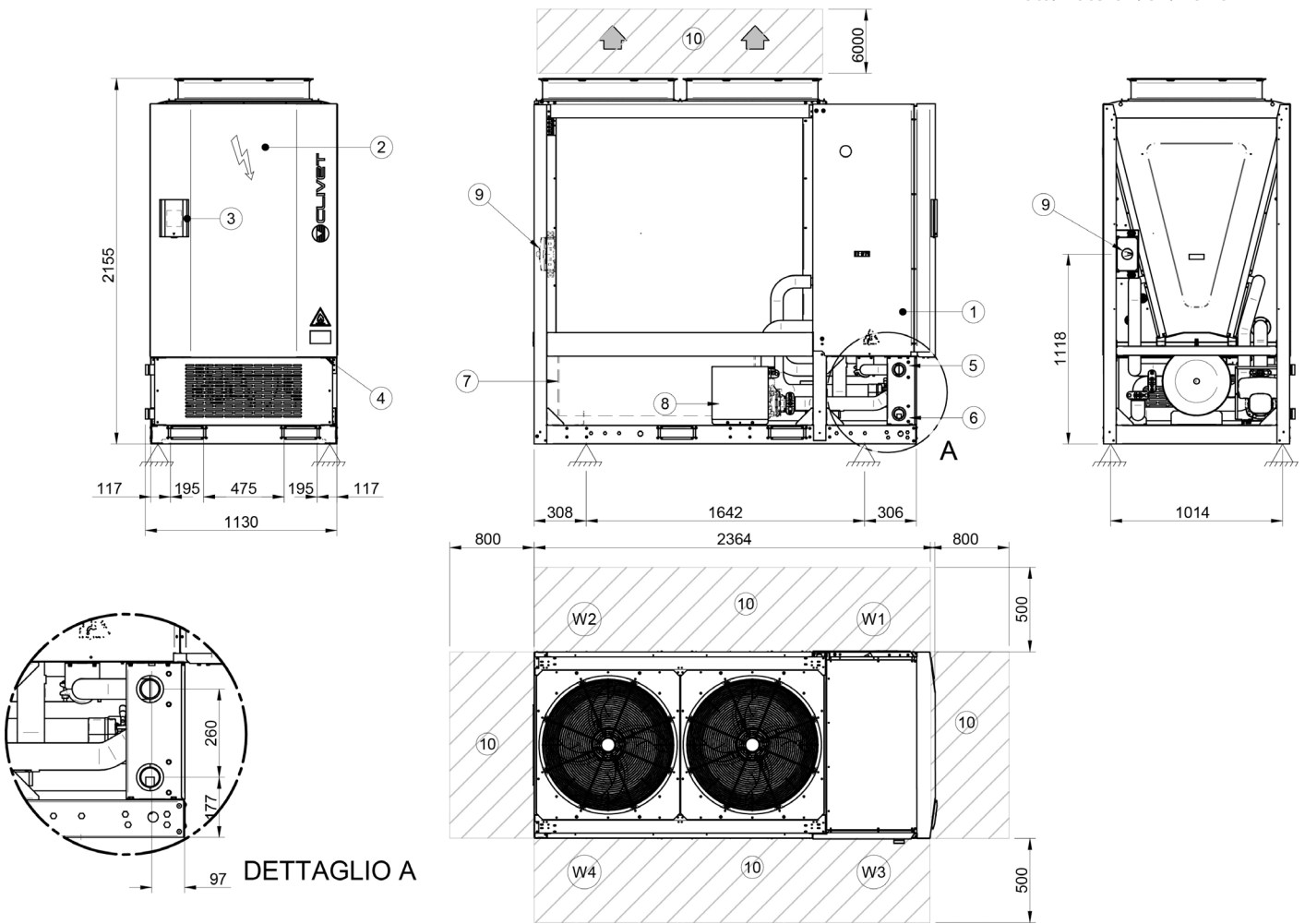

1. Compressor compartment
2. Electrical panel
3. Control keypad
4. Power input
5. Water inlet 2" Victaulic
6. Water outlet 2" Victaulic
7. Water tank (optional)
8. Pump (optional)
9. Main power switch (optional)
10. Functional spaces

SIZE		18.2	20.2
Lenght	mm	2364	2364
Depth	mm	1014	1014
Height	mm	2152	2152
W1 Support point	kg	168	168
W2 Support point	kg	154	154
W3 Support point	kg	168	168
W4 Support point	kg	154	154
Operating weight	kg	659	569
Shipping weight	kg	644	644

The presence of optional accessories may result in a substantial variation of the weights shown in the table.

Dimensional drawings

Size 25.2 - 30.2 - 35.

DAASC0002_REV00
Data/Date 01/04/2021

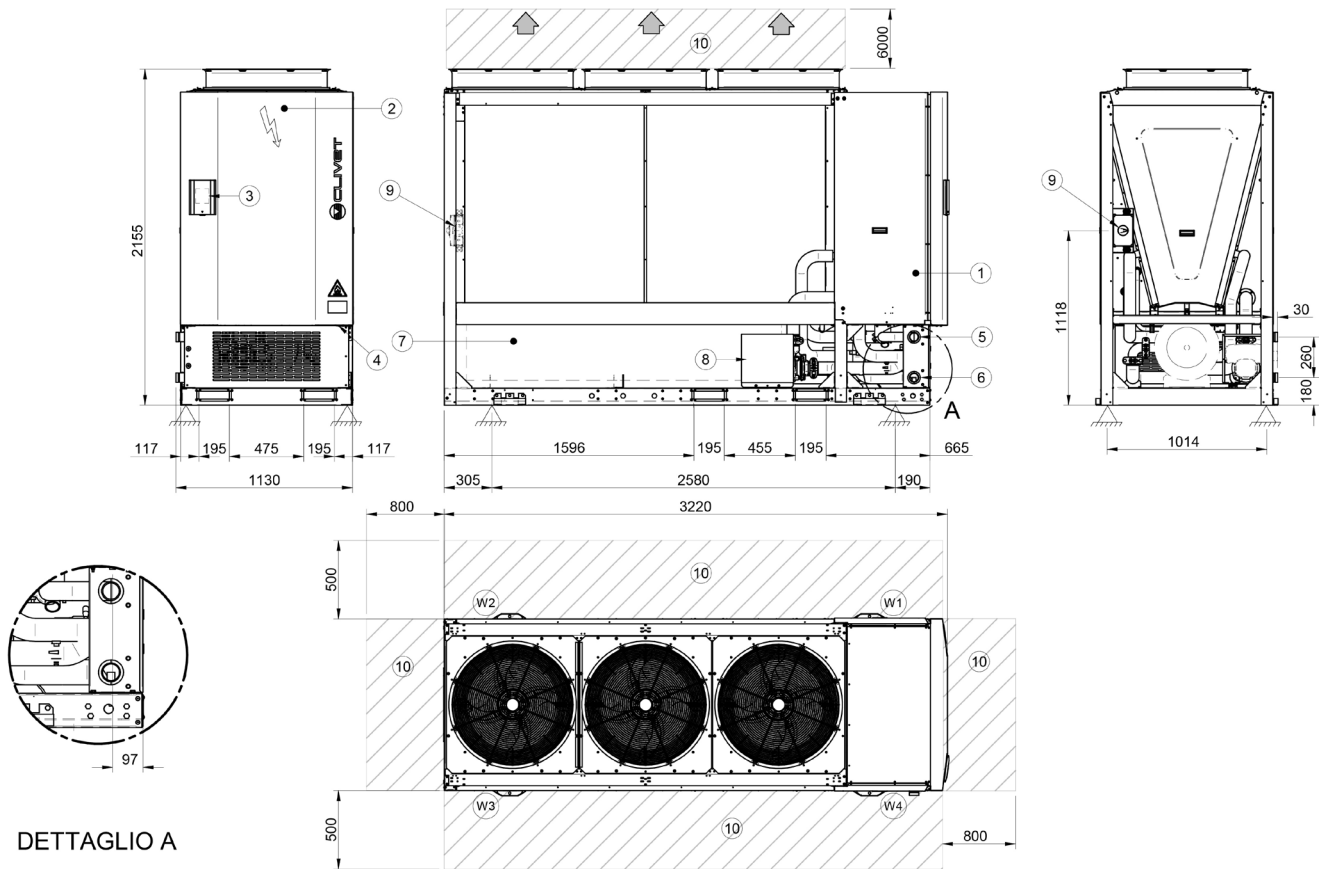

1. Compressor compartment
2. Electrical panel
3. Control keypad
4. Power input
5. Water inlet 2" Victaulic
6. Water outlet 2" Victaulic
7. Water tank (optional)
8. Pump (optional)
9. Main power switch (optional)
10. Functional spaces

SIZE		25.2	30.2	35.2
Lenght	mm	3220	3220	3220
Depth	mm	1130	1130	1130
Height	mm	2153	2153	2153
W1 Support point	kg	278	278	278
W2 Support point	kg	134	134	134
W3 Support point	kg	134	134	134
W4 Support point	kg	278	278	278
Operating weight	kg	850	850	850
Shipping weight	kg	824	824	824

The presence of optional accessories may result in a substantial variation of the weights shown in the table.

Page intentionally left blank

Page intentionally left blank

FOR OVER 30 YEARS WE HAVE BEEN
OFFERING SOLUTIONS TO ENSURE
SUSTAINABLE COMFORT AND THE WELL-
BEING OF PEOPLE AND THE ENVIRONMENT

www.clivet.com

MideaGroup
humanizing technology

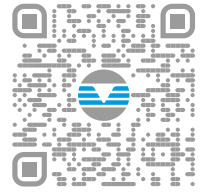

sale and assistance



CLIVET S.p.A.

Via Camp Lonc 25, Z.I. Villapaiera 32032 - Feltre (BL) - Italy
Tel. +39 0439 3131 - info@clivet.it

CLIVET GMBH

Hummelsbütteler Steindamm 84,
22851 Norderstedt, Germany
Tel. +49 40 325957-0 - info.de@clivet.com

Clivet Group UK LTD

Units F5 & F6 Railway Triangle,
Portsmouth, Hampshire PO6 1TG
Tel. +44 02392 381235 -
Enquiries@Clivetgroup.co.uk

CLIVET LLC

Office 508-511, Elektrozavodskaya st. 24,
Moscow, Russian Federation, 107023
Tel. +7495 6462009 - info.ru@clivet.com

CLIVET MIDEAST FZCO

Dubai Silicon Oasis (DSO) Headquarter Building,
Office EG-05, P.O Box-342009, Dubai, UAE
Tel. +9714 3208499 - info@clivet.ae

Clivet South East Europe

Jarušćica 9b
10000, Zagreb, Croatia
Tel. +3851 222 8784 - info.see@clivet.com

CLIVET France

10, rue du Fort de Saint Cyr - 78180 Montigny le
Bretonneux, France
info.fr@clivet.com

Clivet Airconditioning Systems Pvt Ltd

Office No.501 & 502,5th Floor, Commercial -I,
Kohinoor City, Old Premier Compound, Off LBS
Marg, Kirool Road, Kurla West, Mumbai
Maharashtra 400070, India
Tel. +91 22 30930200 - sales.india@clivet.com

ELFOenergy STORM FC - WSAT-YES FC - BT20L008GB-08