

SPHERA EVO 2.0 Invisible

SQKN-YEE 1 IC+MiSAN-YEE 1 S 2.1-5.1



MANUAL

FOR INSTALLATION,
USE AND MAINTENANCE

Change living home

Dear Customer,

We congratulate you on choosing these product



Clivet has been working for years to offer systems able to assure the maximum comfort for a long time with highly-reliable, efficient, high-quality and safe solutions. The target of the company is to offer advanced systems, that assure the best comfort and reduce energy consumption as well as the installation and maintenance costs for the entire life-cycle of the system.

With this manual, we want to give you information that are useful for all phases: from reception, installation and use to disposal - so that such an advanced system can provide the best performances during installation and use.

Best regards and have a good read.

CLIVET Spa

The data contained in this manual is not binding and may be changed by the manufacturer without prior notice. Reproduction, even partial, is FORBIDDEN. © Clivet S.p.A. - Feltre (BL) - Italia

	Rapid guide	4
	1 Safety considerations	19
	2 Information on refrigerant gas	25
	3 General	26
	4 Reception	27
	5 Installation requirements	30
	6 Water connections	46
	7 Refrigerating connections	51
	8 Electrical connections	56
	9 Start - up	66
	10 Control	90
	11 Maintenance	141
	12 Disposal	155
	13 Technical data	156
	14 Boiler connections	165
	15 Energy data sheets and labelling	173

Pay particular attention to:



INSTALLER use



USER use



STD UNIT INSTALLATION

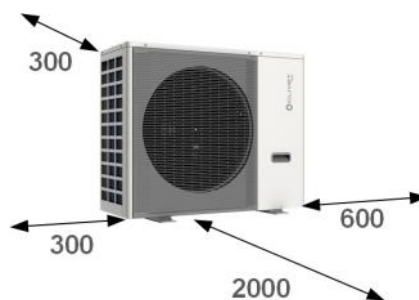
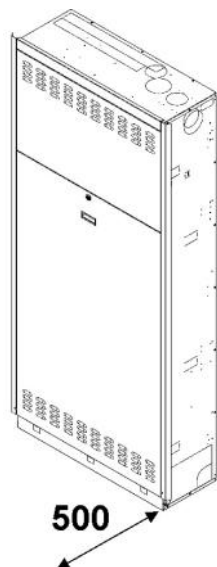

Indoor unit	
Width	350
Length	950
Height	2200
kg	65

Outdoor unit		
Size .	2.1-3.1	4.1-5.1
Width	426	523
Length	986	1104
Height	712	886
kg	58	77



IDROBOX installation

Attention!

First install the storage tank (A), see PE instructions. Remove the protective caps (B)

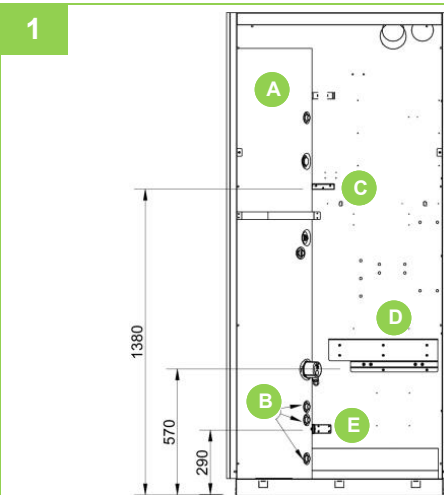

1 Install supports C, D, E

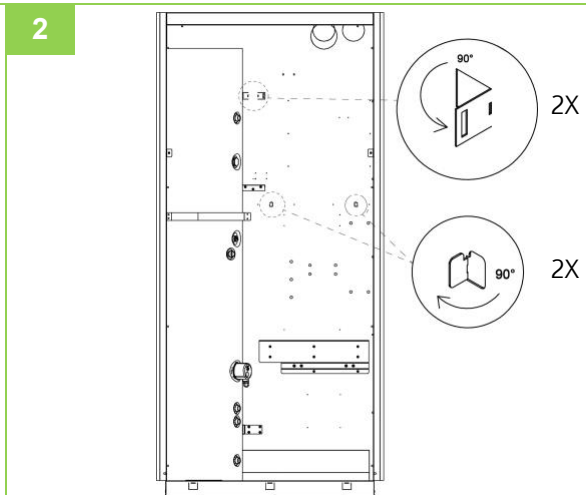

2 Open the precuts

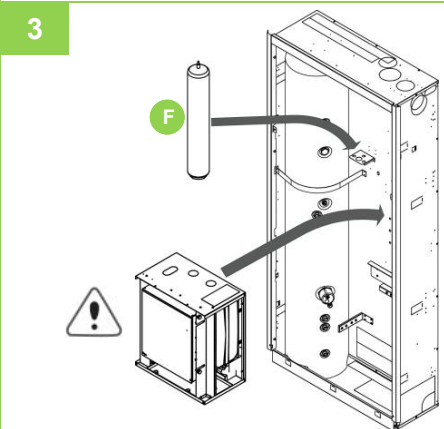

3 Install fitting T on the DHW expansion vessel (F) (max. 6 bar)
ATT. The hydronic unit weighs around 45 kg.

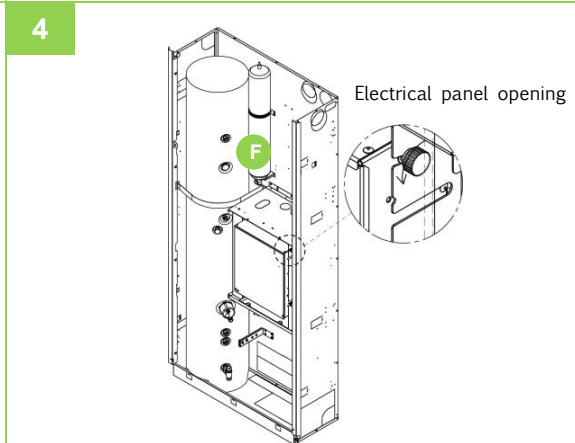

4 Route the clamps through the tabs (F) to secure the expansion vessels.

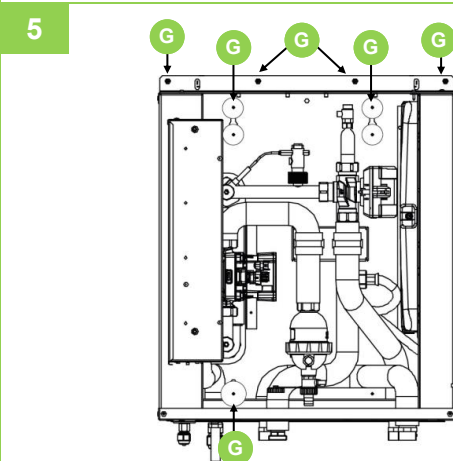

5 Secure the hydronic module with screws

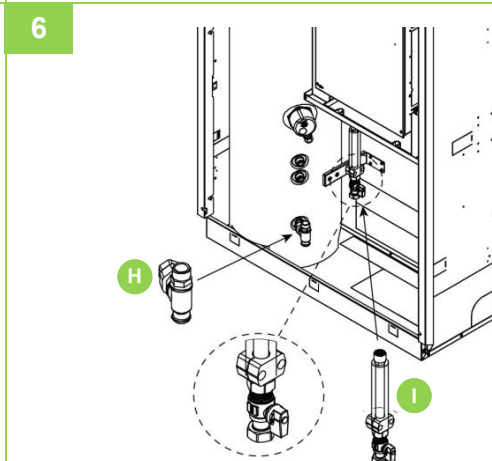

6 Install fitting (H)



7

Install thermostatic valve (L) + DHW safety valve + gasket
Install pipe (M) + gaskets

8

Fix pipe + gaskets.

9

Install ACS pipe + gaskets

10

Install pipes + gaskets:
N - DWH return
O - DWH outlet
P - Install valve

11

Secure the pipes with the brackets



REFRIGERATOR CONNECTIONS

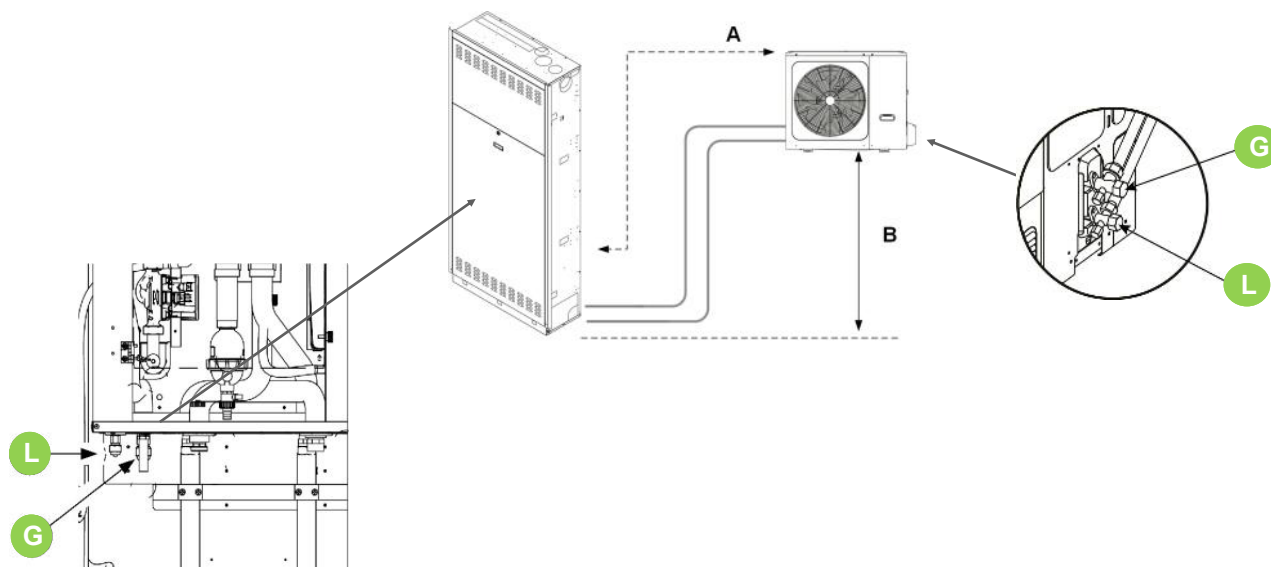

Use the components supplied with the unit or perform flaring to make the connections.

Maximum distances			2.1 - 5.1
Refrigerant pipe min/max equivalent length	A	m	3 - 30
Maximum refrigerant pipe height difference with outdoor unit higher than indoors unit	B	m	25
Maximum refrigerant pipe height difference with outdoor unit underthan indoor unit.	B	m	25

Type of pipes		2.1 - 3.1	4.1 - 5.1
Liquid Ø external	L	1/4" (6,3mm) *	3/8" (9,5mm)
Gas Ø external	G	5/8" (15,9mm)	5/8" (15,9mm)
Min. thickness gas		0,8 mm	
Min. thickness liquid		0,8 mm	

* Reduction 10-6 for outdoor unit size 2.1-3.1



Additional refrigerant charge		2.1 - 3.1	4.1 - 5.1
Further refill for distance exceeding 15 metres (kg/m)		0,02	0,038



Water connections

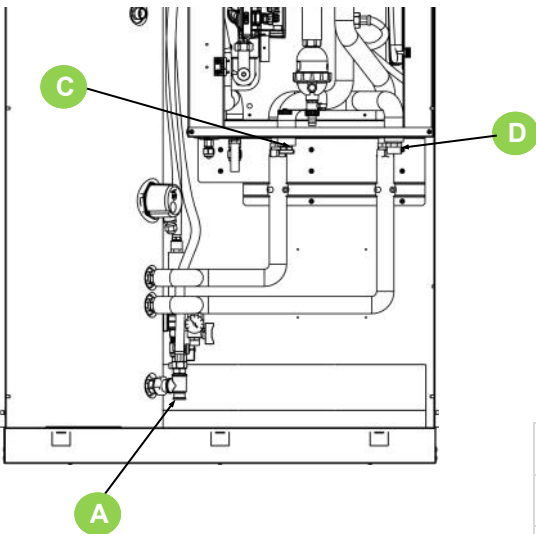
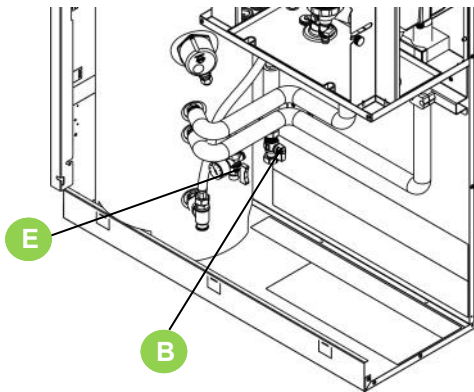

N°	Description	Ø
A	Aqueduct inlet	3/4"
B	DWH outlet	3/4"
C	System outlet	1"
D	System return	1"
E	System load	1/2"

Condensate drain / valve





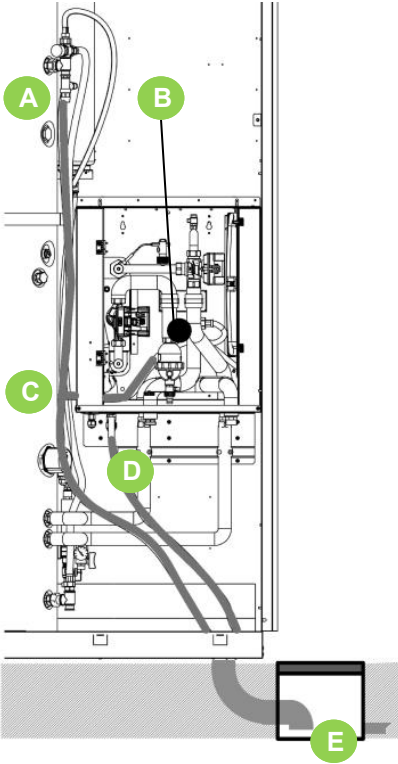

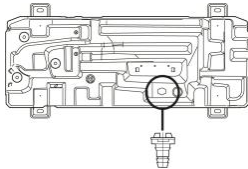
Size 2.1 - 3.1

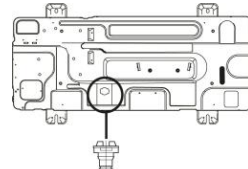

Size 4.1 - 5.1

A	DHW safety valve (6 bar)
B	System safety valve : discharge in pressure (3 bar)
C	Connection " T " + safety valve discharge A+B Ø 12mm
D	Condensate drain connection Ø 18mm
E	Drain accumulation / drain pit



HYDRAULIC CONNECTION SCHEMA

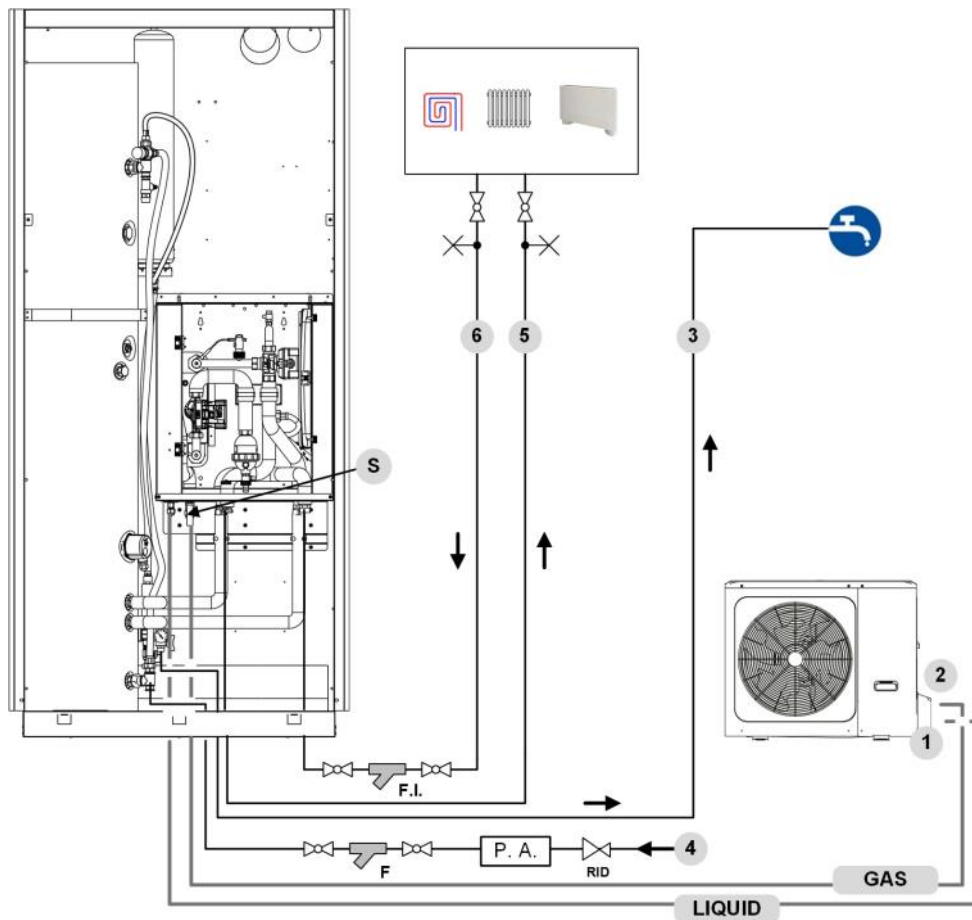

Indicative plumbing diagram

The system components must be defined by Designer and Installer (ex. expansion tanks, vents, taps, calibration/safety valves etc.)

1	Refrigerant line Ø 3/8" (liquid)
2	Refrigerant line Ø 5/8" (gas)
3	Domestic hot water output ø 3/4"
4	Aqueduct input ø 3/4"
5	System water supply ø 1"
6	System water return ø 1"

S	Condensate drain Ø 18mm
VR	check valve *
F.I.	System filter *
F	Water filter (supplied as standard)
P.A.	Descaler protection*
RID	Pressure reducing valve*
	Vent*
	Cut-off valves*

* provided by the Customer



In the tightening operations always use the wrench and backup wrench.



ELECTRICAL CONNECTIONS



Access to the internal parts

- 1 Panel opening
- 2 Remove the panel
- 3 Remove the screws (A) / Remove the panel

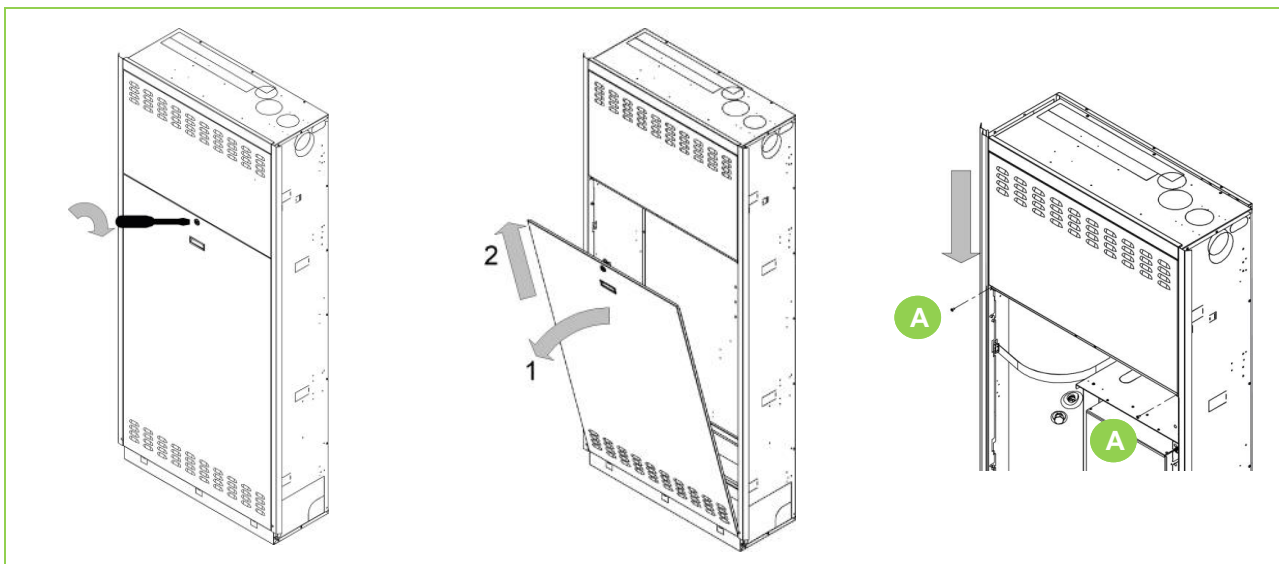

Internal unit connections

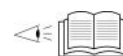

Carry out the connection in accordance with the electric connection layout.

Wiring size (mm²) = 1,5

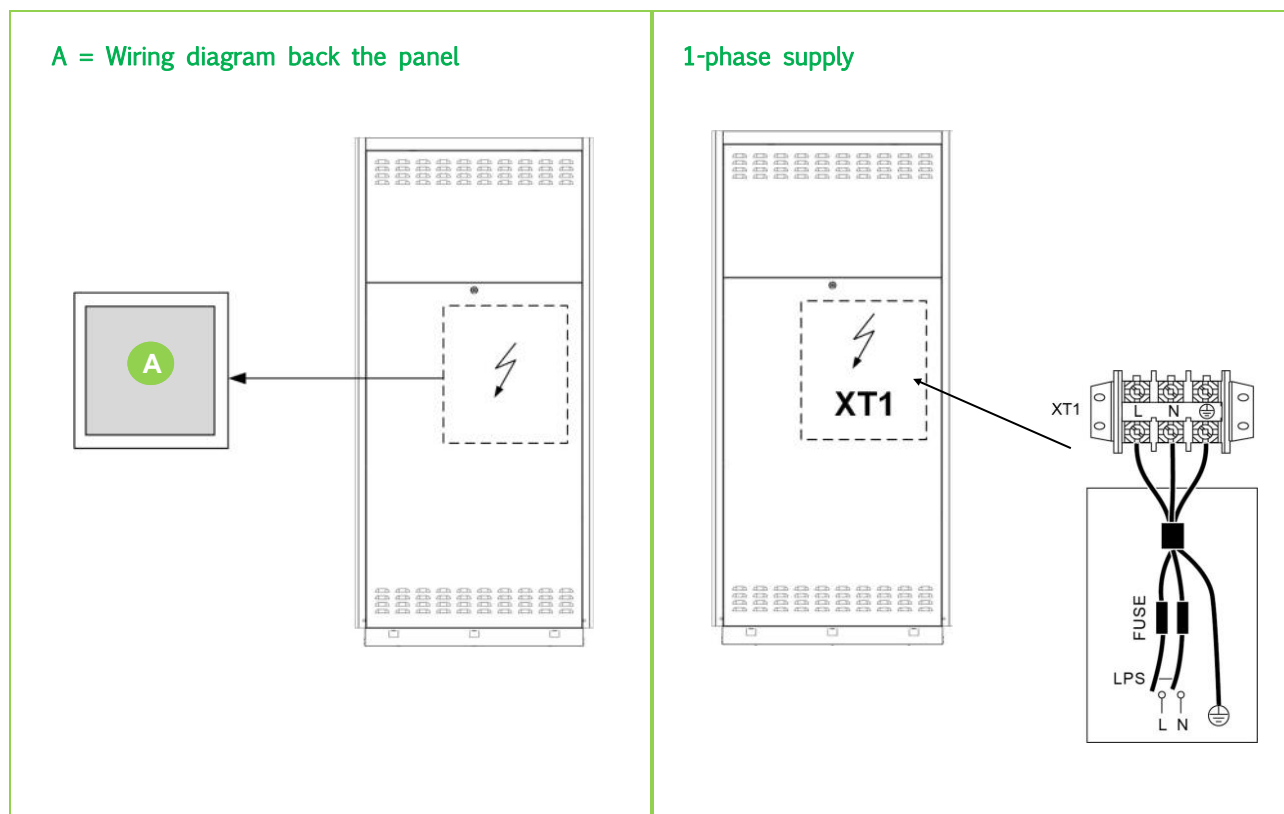



External unit connections



Remove the protective cover (A)

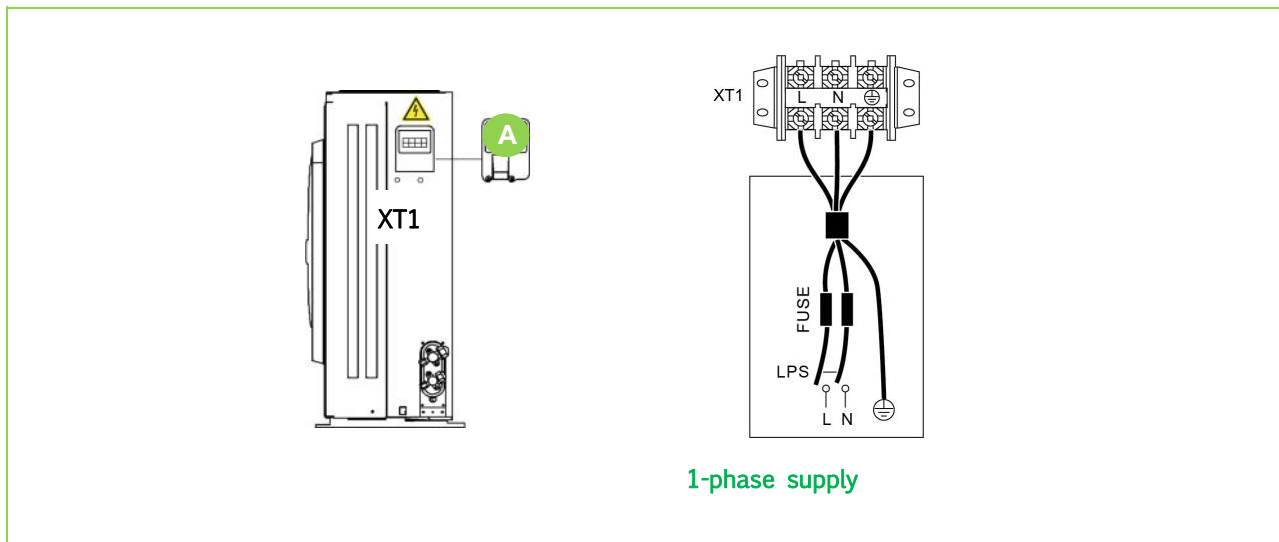

Unit (size)	1-phase	
	2.1-3.1	4.1-5.1
Maximum overcurrent protector (MOP)	18	19
Wiring size (mm ²)	4	4

Bus connections

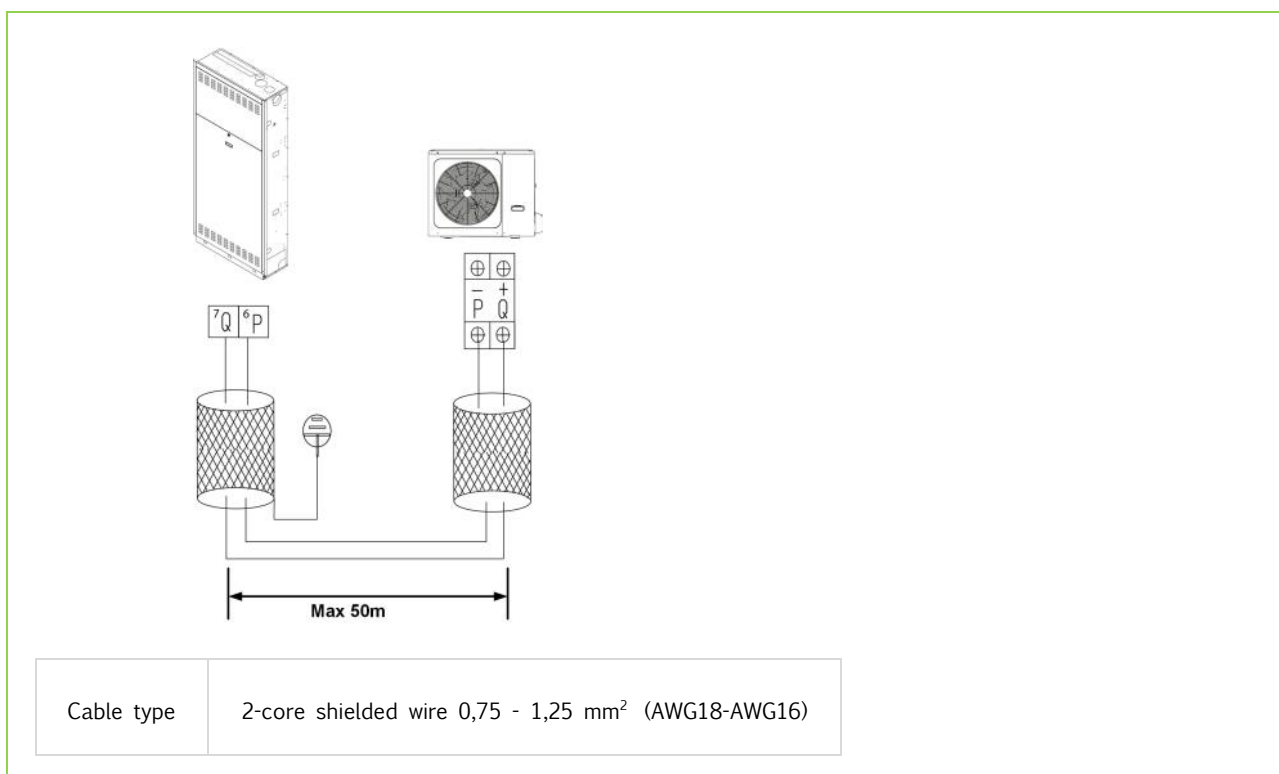



1 zone system

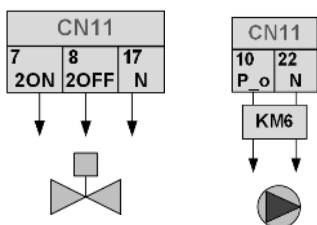
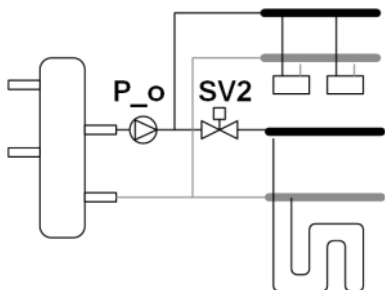

counter for components with absorption greater than 0.2A

2 mixed zone system

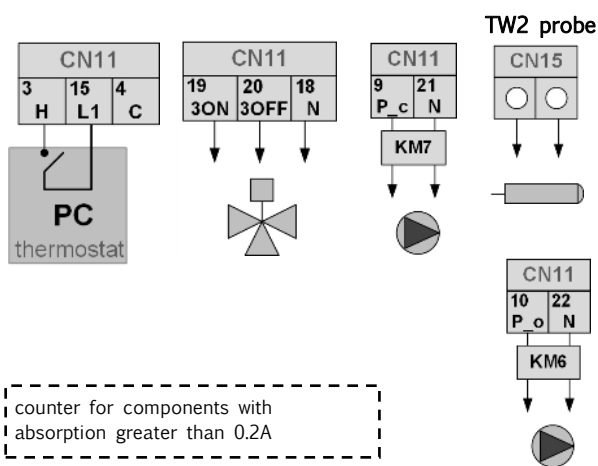
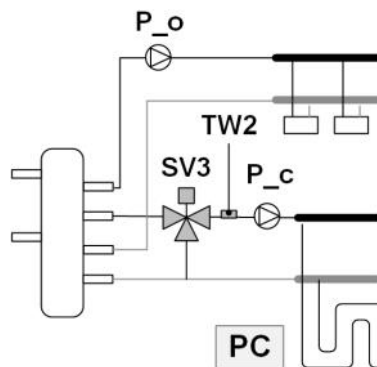

counter for components with absorption greater than 0.2A

Solar

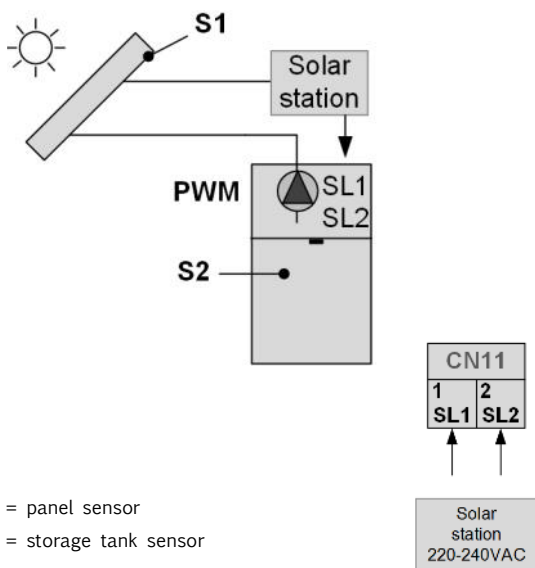

S1 = panel sensor
S2 = storage tank sensor

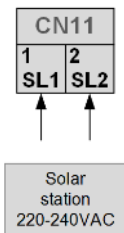

counter for components with absorption greater than 0.2A

DHW recirculation

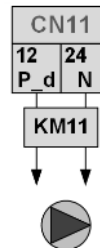
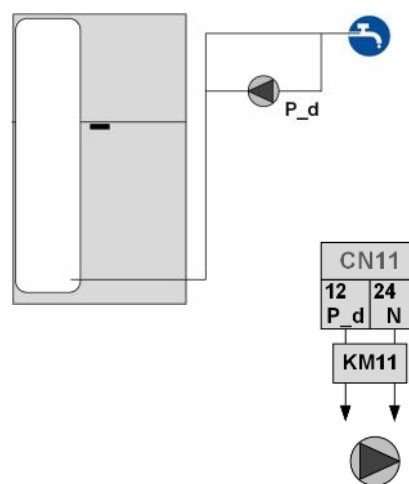

counter for components with absorption greater than 0.2A



Additional heat source (boiler)

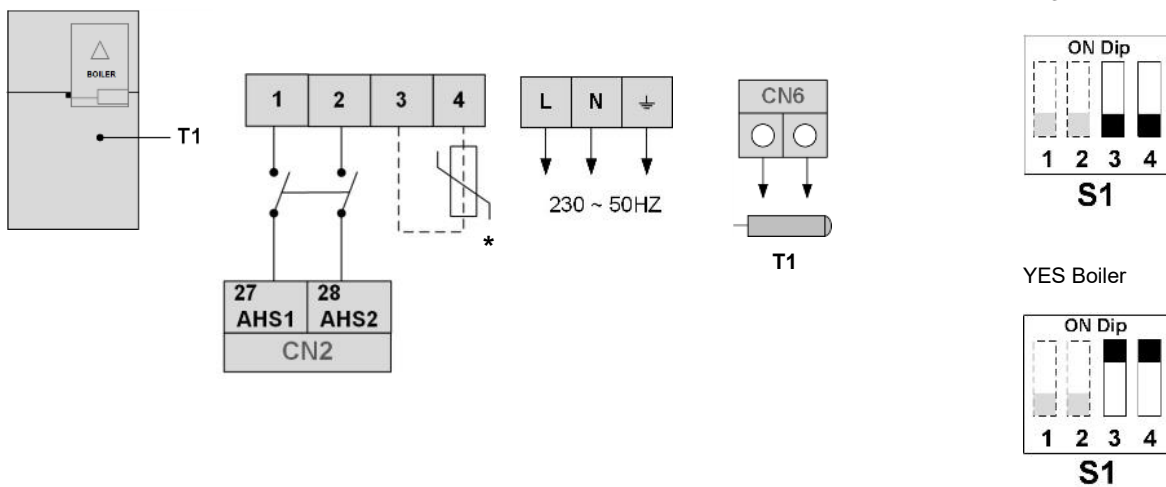

counter for components with absorption greater than 0.2A

T1 = Outlet water temperature probe
 * External temperature probe (supplied with the boiler)

Room thermostat - Not supplied



There are three methods for connecting the thermostat cable and it depends on the application.

User interface setting:

For service man > 6. Room thermostat >
 6.1 Room thermostat to Mode set

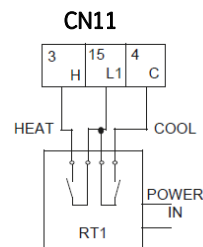

User interface setting:

For service man > 6. Room thermostat >
 6.1 Room thermostat to One zone

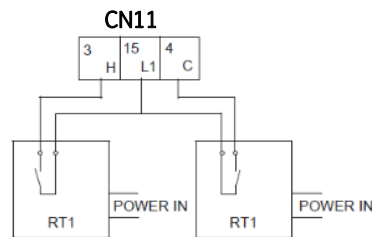

User interface setting:

For service man > 6. Room thermostat >
 6.1 Room thermostat to Double zone

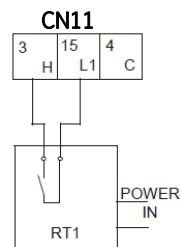



START-UP



Domestic hot water tank charge

Maximum DWH system pressure 6 bar

DWH safety valve setting 6 bar

- 1 System general switch = OFF.
- 2 Close the DWH drain valve (A)
- 3 Start the filling opening the water loading valve DWH (B)
- 4 Open the valve (C) DHW outlet
- 5 Open the hot water taps (bathroom and kitchen)
- 6 Close the taps when water starts to come out.
- 7 Check the hydraulic seal of the joints.

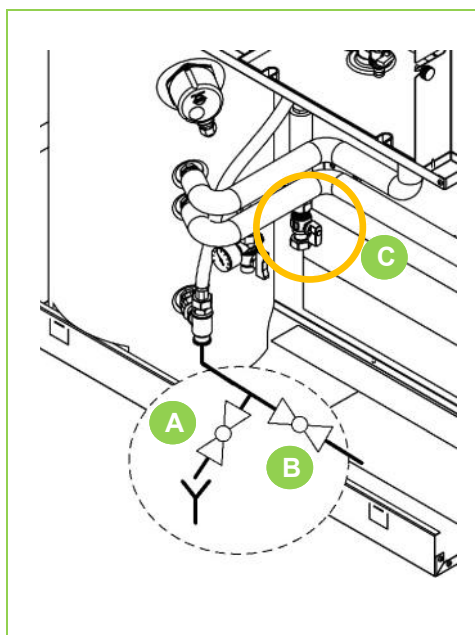

System charge heating/cooling

- 1 Switch ON the unit
 - 2 From the keyboard put ON the domestic hot water mode and wait until the lever of the 3 way valve goes to the right,
 - 3 Switch OFF the unit
 - 4 Press on the lever and move it to the centre until it locks
 - 5 Start the filling opening the tap (B)
 - 6 Open the tap (D) system load
 - 7 Open the taps (E) if present (system)
 - 8 Open the vent valves of the terminals or radiators
 - 9 Close them when water begins to exit; continue the charging until the pressure intended for the system (max.3 bar).
 - 10 Check the hydraulic seal of the joints.
- Once the process is finished, the valve goes to heating/cooling mode automatically when will be power on.
 - Repeat the operation after the unit has operated for a number of hours and periodically control the system pressure. Reintegration is carried out when the unit is off (pump OFF).

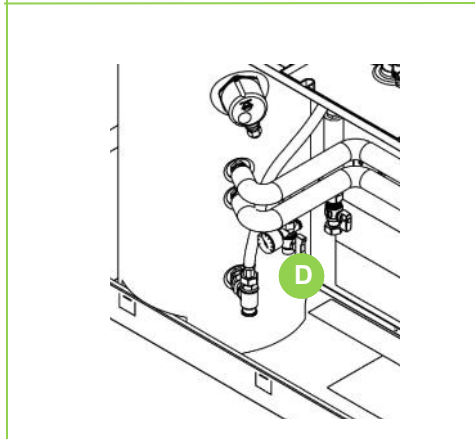
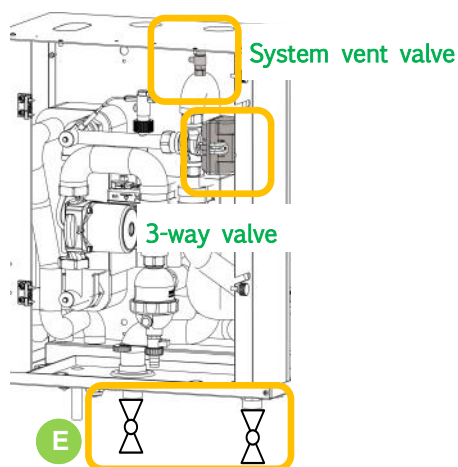
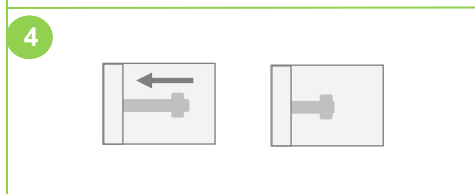
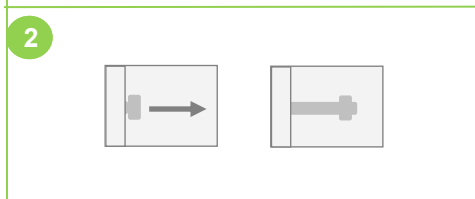
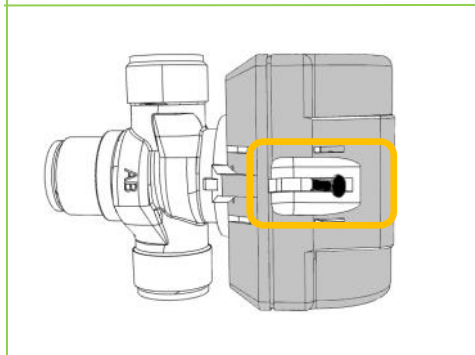

ATTENTION

During installation, use and maintenance operations, the motor must NOT be removed.

In case of extraordinary maintenance see chapter MAINTENANCE



√	Preliminary checks	
1	<input type="checkbox"/> Are the functional spaces of the internal unit and the external unit being observed ?	
2	<input type="checkbox"/> Is the section of the cooling lines correct ? Have the supplied sealing couplings <u>been</u> used ?	
3	<input type="checkbox"/> Does the equivalent length of the refrigerant piping exceed 3 or $\leq 30m$?	
4	<input type="checkbox"/> Is the height different of the refrigerant piping below 25m?	
5	<input type="checkbox"/> Have emptying and additional load been carried out ? Was there a visual check for oil / leaks ?	
6	<input type="checkbox"/> Water features are suitable? The hydraulic system has been cleaned?	
7	<input type="checkbox"/> Is the water filter from the waterworks inlet correctly installed ?	
8	<input type="checkbox"/> Is the system filter on the supply correctly installed?	
9	<input type="checkbox"/> Are the inlet and outlet of the water lines correct ?	
10	<input type="checkbox"/> Is there a non-return valve on the DHW recirculation line?	
11	<input type="checkbox"/> Present safety valve on the DHW side?	
12	<input type="checkbox"/> Present expansion vessel on the DHW side?	
13	<input type="checkbox"/> Does the system contain the minimum required amount of water?	
14	<input type="checkbox"/> Are the anti-vibration joints on the hydraulic connections present ?	
15	<input type="checkbox"/> Was the system loaded, placed under pressure and was the air let out ?	
16	<input type="checkbox"/> Have you verified the expansion tank charge ?	
17	<input type="checkbox"/> Was the condensate produced by the external unit drained correctly ? Can it freeze ?	
18	<input type="checkbox"/> Have the electrical connections to the external unit been made ?	
19	<input type="checkbox"/> Earthing connection? Is the power supply correct ?	
20	<input type="checkbox"/> Are the system temperature and the room temperature with the operating limits ?	
21	<input type="checkbox"/> Is the screed "dry" ? (only in presence of radiant panels)	
22	<input type="checkbox"/> Has the carter resistance been charged for at least 8 hours ?	
23	<input type="checkbox"/> Select keyboard language	
24	<input type="checkbox"/> Set date and time	
25	<input type="checkbox"/> Sanitary water and system personalisation	
26	<input type="checkbox"/> Compile documentation	



SETTINGS



Keys		Function
	MENU	Go to the menu structure(on the home page)
	ON / OFF	Turn on/off the space heating/cooling operation or DHW mode Turn on/or off functions in the menu structure
	UNLOCK	Long press 3 sec. for unlock /lock the controller
	OK	Enter a sub-menu Confirm entered values
 	SX - DX DOWN - UP	Navigate in the menu structure, adjust settings
	BACK	Come back to the up level



Menu structure

Press 3 sec. "UNLOCK" to unlock the keyboard.

Operation mode

Heat
Cool
Auto

Preset temperature

Preset temperature
Weather temperature set
ECO mode

Domestic hot water (DHW)

Disinfect (anti-legionella)
Fast DHW
Tank heater
DHW pump (recirculation)

Schedule

Timer
Weekly schedule
Schedule check
Cancel timer

Options

Silent mode
Holiday away
Holiday home
Backup heater

Child lock

Please input the password
Cool/heat temp. adjust
Cool/heat mode on/off
DHW temp. adjust
DHW mode on/off

Service information

Service call
Error code
Parameter
Display

Operation parameter

Consultation only

For serviceman *

Please input the password
DHW mode setting
Cool mode setting
Heat mode setting
Auto mode setting
Temp. type setting
Room thermostat
Other heating source
Holiday away setting
Service call
Restore factory settings
Test run
Special function
Auto restart
Power input limitation
Input define
Cascade set
HMI address set

* The access by pwd is reserved to qualified personnel; The parameters changes may cause malfunctions

Wlan setting

Ap mode
Restore wlan setting

Sn view

LIST OF ACCESSORIES SEPARATELY SUPPLIED

Indoor unit	
KIR2HX	2 zones: both at high temperature
KIR2HLX	2 zones: high temperature + low temperature (mixed)
KCVEX	Circulation kit: circulation group, control unit, expansion tank
KCSX	Kit for secondary circuit (1L hydraulic separator + pump)
KPRSX	DHW recirculation pump kit
AC50X	50-liter inertial storage tank for indoor installation
ACE50X	50-liter inertial storage tank for outdoor installation
ADI50X	Recessed storage unit for external inertial accumulation
ACSA50X	Additional 50-liter domestic hot water storage
ACSA150X	Additional 150-liter domestic hot water storage
ADIAX	Recessed storage unit for additional DHW accumulation

System	
HID-TCXB	WHITE chronothermostat with soft touch display, temperature control and management via App / Voice control, for semi-uncased installation
HID-TCXN	BLACK chronothermostat with soft touch display, temperature control and management via App / Voice control, for semi-uncased installation
SWCX	SwitchConnect radio receiver

Outdoor unit	
DTX	Auxiliary condensate collection tray
APAVX	Kit of antivibration mounts for floor installation
ASTFX	Kit of antivibration mounts for wall bracket installation
KSIPX	Wall fixing bracket kit

Hybrid solution	
CCGIX	Integration condensing boiler
KSDFX	Twin Pipe Flue System
KAS80X	Suction and exhaust fittings 80mm diameter
KTCGPLX	Conversion kit boiler from methane to LPG



pipes may be very hot and you may burn your hands. To avoid lesions, wait until the pipes return to a normal temperature or make sure you are wearing protective gloves.

- ⇒ *Do not touch any switch with wet hands. Touching a switch with wet hands may lead to electric shock.*

WARNING

- ⇒ *The power supply of the series complies with IEC / EN 61000-3-11 and must be connected to a suitable power supply network, in able to support a maximum system impedance of $Z_{max} = 0.351$ ohm on the interface. Keep in touch with the supply authority so to ensure that the power supply is connected only to a power supply with an impedance no more than the one shown above.*
- ⇒ *Maintenance operations must be performed as recommended by the manufacturer. Maintenance and reparation operations requiring the assistance from specialized personnel must be performed under the supervision of the person competent as regards flammable refrigerants.*
- ⇒ *Tear and dispose of plastic bags so that children may not play with them. Children playing with plastic bags risk choking.*
- ⇒ *Some products use PP packaging straps. Do not pull the straps or use them to lift or move the product. It may be dangerous should the straps break.*
- ⇒ *Dispose safely of packaging material such as nails or other metal or wooden parts that may cause lesions.*
- ⇒ *Ask your dealer or qualified personnel to perform installation operations according to this manual. Do not install the unit yourself. An incorrect installation may cause water leaks, electric shock or fire.*
- ⇒ *Make sure to only use accessories and parts specified for installation operations. Failing to use specific parts may cause*



Warning:
Fire hazard
Flammable materials



SAFETY

Operate in compliance with safety regulations in force .

Use single protection devices:
gloves, glasses, helmet, etc..

The precautions in this manual are divided as indicated on the side.

They are important, so make sure you follow them closely.

Please read these instructions carefully before installing.

Keep this manual handy for future reference.

This unit contains fluorinated gases. For specific information on gas types and quantities, please refer to the plate found on the unit.

Please contact your dealer for future assistance.

DANGER

⇒ *An incorrect installation of equipment or accessories may provoke electric shocks, short circuits, leaks, fire or other damages to the equipment. Make sure you only use accessories provided by the supplier - which are designed specifically for the equipment - and make sure they are installed by a professional.*

⇒ *All activities described in this manual must be performed by authorised technicians. Make sure to wear suitable personal protection such as gloves and safety goggles while installing the unit or performing maintenance operations.*

⇒ *Switch off the power switch before touching electrical components and terminals.*

⇒ *When the service panels are removed, the live parts can easily be touched by mistake.*

⇒ *Never leave the unit unattended during installation or maintenance operations while the service panel is removed.*

⇒ *Do not touch the water pipes during and after performing welding or junction work as the*



Meaning of the symbols DANGER, WARNING, CAUTION and NOTE

DANGER

⇒ *It indicates a situation of imminent danger that, if not avoided, will cause death or serious lesions.*

WARNING

⇒ *It indicates a potentially dangerous situation that, if not avoided, may cause death or serious lesions.*

CAUTION

⇒ *It indicates a potentially dangerous situation that, if not avoided, may cause slight or moderate injury. Also used to warn against unsafe practices.*

NOTE

⇒ *It indicates situation that may cause accidental damage to the equipment or property.*



- ⇒ *water leaks, electric shock, fire or the unit falling from its support.*
- ⇒ *Install the unit on a structure that can withstand its weight. An insufficiently robust structure may lead to the unit falling causing possible lesions.*
- ⇒ *Perform installation operations considering the possibility that strong winds, hurricanes or earthquakes may occur. Incorrect installation operations may lead to accidents caused by falling equipment.*
- ⇒ *Make sure all electrical operations are performed by qualified personnel in accordance with the law, local regulations and this manual.*
- ⇒ *Connect the unit to a separate power supply circuit. An insufficient capacity of the power supply circuit or incorrect connections may lead to electric shock or fire.*
- ⇒ *Make sure to install an additional differential circuit-breaker against a leakage to earth compliant with the law and local regulations: omnipolar circuit breaker, at least 3 mm separation in all poles, residual current device (RCD) with a rated value not exceeding 30 mA.*
- ⇒ *Failing to install a differential circuit-breaker may lead to electric shock and fire.*
- ⇒ *Make sure all the wiring is safe. Use the specified wires and make sure terminal connections and wires are protected against the water, external forces or other phenomena. Incomplete connections or fixing may cause a fire.*
- ⇒ *When connecting the power supply, arrange the wires so that the front panel can be fixed properly. If the front panel is not in position, it may lead to terminals overheating, electric shock or fire.*
- ⇒ *People working or intervening on a cooling circuit must hold a suitable certification issued by an authorised assessment centre proving their suitability to handle refrigerants safely in*



compliance with a specific assessment recognised by industry associations.

- ⇒ *After installation operations are over, verify that there are no refrigerant leaks.*
- ⇒ *Never touch the leaking refrigerant directly, as it may lead to serious frostbite injuries. Do not touch the refrigerant pipes during and right after functioning, as they may be hot or cold depending on the conditions of the refrigerant flowing through the pipes, compressor and other parts of the cooling circuit. Burns or frostbite may occur if you touch the refrigerant pipes. If it is necessary to touch the pipes, wait for them to return to a normal temperature or wear protective gloves and clothes.*
- ⇒ *Do not touch the internal parts (pump, backup heater, etc.) during and immediately after functioning. Touching internal parts may cause burns. To avoid lesions, wait until the internal parts have returned to a normal temperature or, if touching them is necessary, wear protective gloves.*
- ⇒ *Do not use other means than those recommended by the manufacturer to hasten the defrosting or cleaning process.*
- ⇒ *The equipment must be placed somewhere without continuous ignition sources (e.g. open flame, a gas-operated device or an electric heater).*
- ⇒ *Do not pierce nor burn.*
- ⇒ *Be aware that refrigerants are odourless.*

CAUTION

- ⇒ *Place the unit on the ground.*
- ⇒ *The earth resistance should comply with the law and local regulations.*
- ⇒ *Do not connect the earth cable to gas or water mains, lightning rods or phone earth cables.*
- ⇒ *Incomplete earthing may cause electrical shocks.*





- Gas mains: fires or explosions may occur in case of a gas leak.
 - Water mains: rigid vinyl tubes are not effective.
 - Lightning rods or phone earth cables: the electrical threshold can increase abnormally if hit by lightning.
- ⇒ *Install the power supply cable at least one metre from TVs or radios to prevent interferences or disturbances. Depending on the type of radio wave, one metre may not be enough to avoid disturbances.*
- ⇒ *Do not wash the unit as it may cause electric shocks or fires.*
- ⇒ *If the power supply cable is damaged, it must be replaced by the producers, personnel from its assistance network or qualified personnel.*
- ⇒ *Do not install the unit in the following places:*
- Where there is mineral oil, even in form of vapour. Plastic parts may deteriorate, disperse and cause water leaks.
 - Where corrosive gases (such as sulphurous acid) are produced.
 - Where the corrosion of copper pipes or welded parts may cause refrigerant leaks.
 - Where there are devices emitting electromagnetic waves. Electromagnetic waves may disturb the control system and cause malfunctions.
 - Where flammable gases may leak, or carbon fibre or flammable powers may be found in the air or where volatile flammable materials such as paint thinners or petrol are handled. These gases may cause a fire.
 - Where the air contains high levels of salt, such as the seaside.
 - Where the power supply voltage is subject to fluctuations, such as in factories.
 - On vehicles or ships.
 - Where there are acid or alkaline vapours.
- ⇒ *Prior to installation, verify if the user's power supply meets the unit's installation requirements (including reliable earthing,*



differential circuit-breaker, component size, wire section, etc.). If the electrical installation requirements are not met, the unit cannot be installed until the electrical system is rectified.

- ⇒ Before the hydraulic connection and electrical wiring operations, verify that the installation area is safe and without hidden dangers such as water, electricity and gas conduits.*
- ⇒ Do not touch the fins of the heat exchanger as they may cause injury.*
- ⇒ If installing multiple units in a centralised manner, adjust the electric load on the various phases. Do not connect multiple units to the same phase of the three-phase supply.*
- ⇒ The following subjects may use the unit if supervised or instructed on safe usage and capable of understanding the possible dangers: children who are minimum 8 years old, people with no experience or knowledge, people with limited physical, sensory or mental abilities.*
- ⇒ Children should be supervised to ensure that they do not play with the appliance.*
- ⇒ Cleaning and maintenance operations to be carried out by the user must not be performed by unsupervised children.*
- ⇒ Once the installation is complete, the unit tested and functioning is normal, instruct the client as regards the use and maintenance of the unit as indicated in this manual. In addition, make sure that the manual is suitably kept for future reference.*
- ⇒ DISPOSAL: do not dispose of this product as unsorted waste. Contact the local authorities for information on the collection systems available. If electrical equipment is disposed of in landfills, dangerous substances may infiltrate the waste water and enter the food chain, harming the health and well-being of people and animals.*





This product contains fluorinated greenhouse gases covered by the Kyoto protocol. Do not discharge gas into air.

Refrigerant type: R32

Characteristics of R32 refrigerant:

- minimum environmental impact thanks to the low Global Warming Potential GWP
- low flammability, class A2L according to ISO 817
- low combustion speed
- low toxicity

The refrigerant quantity is indicated on the unit plate

Quantity factory-loaded refrigerant and equivalent CO₂ tons:

Size	Refrigerant (kg)	Equivalent CO ₂ tons
2.1 - 3.1	1,55	1,05
4.1 - 5.1	1,65	1,11

Physical characteristics of the R32 refrigerant		
Safety class (ISO 817)	A2L	
GWP	675	
LFL Low flammability limit	0.307	kg/m ³ @ 60°C
BV Burning velocity	6,7	cm/s
Boiling point	-52	°C
GWP	675	100 yr ITH
GWP	677	ARS 100 yr ITH
Self-ignition temperature	648	°C



UNIT IDENTIFICATION

Serial number label

The serial number label is positioned on the unit and allows to identify all the unit features.

Warning

⇒ *It has not to be removed for any reason.*

It reports the regulations indications such as:

- machine type, exemple
- size
- serial number
xxxxxxxxxxx
- year of manufacture
- wiring diagram number
- electrical data
- manufacturer logo and address .

Serial number

It identifies uniquely each machine.

It identifies specific spare parts for the machine.

Assistance request

Note data from the serial number label and write them in the chart on side, so you will find them easily when needed.

In case of intervention you have to provide data.

Serie
Size
Serial number
Year of manufacture
Wiring diagram

Preliminary information

NOTE

Before beginning the work, ensure you that have the final project for installing the system and positioning the units.

Operate in compliance with safety regulations in force .

Use single protection devices.



Before accepting the delivery you have to check:

- that the unit hasn't been damaged during transport.
- Check that the materials delivered correspond with that indicated on the transport document comparing the data with the identification label 'A' positioned on the packaging.

In case of damage or anomaly:

- Write down on the transport document the damage you found and quote this sentence: "Conditional acceptance clear evidence of deficiencies/damages during transport".
- Contact supplier and the carrier by fax and registered mail with advice of receipt.

NOTE

⇒ Any disputes must be made within the 8 days following the delivery. Complaints after this period are invalid.

Storage

Shelter from: direct sunlight, rain, sand and wind.

Stocking temperature:

maximum 50°C

minimum -10°C

NOTE

⇒ The respect of the instructions on the exterior side of the packaging assures the physical and functional integrity of the unit for the final user's advantage.

Handling

Before handling verify that the unit keeps its balance.

The following examples are indications the choice of the means and of the handling modes will depend on factors.

- 1 Verify unit weight and handling equipment lifting capacity .
- 2 Identify critical points during handling (disconnected routes, flights, steps, doors).
- 3 Stair climbing trolley.
- 4 Use protection (A) to avoid the unit damaging
- 5 Recessed cabinet, fork input side (B)
- 6 150-litre storage tank © + unit components kit
- 7 Hydraulic module + electric panel (D)

DANGER

⇒ It is strictly forbidden to stand under the machine when it is lifted.



1



2

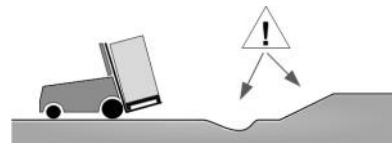

3



4

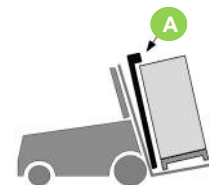

5

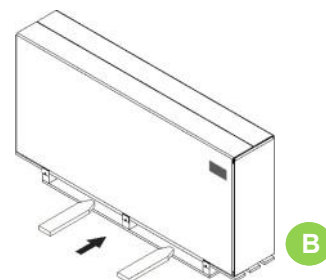

6

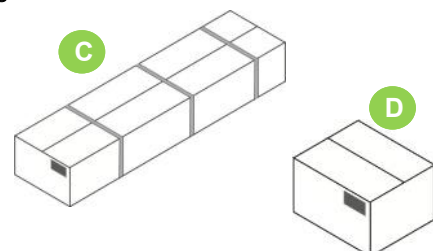



External unit

- 1 Fork input side
- 2 Input side for lifting by crane
- 3 Do not lean it more than 45°, and do not lay it sidelong
- 4 Do not lean it more than 45°, and do not lay it sidelong

DANGER

⇒ It is strictly forbidden to stand under the machine when it is lifted.

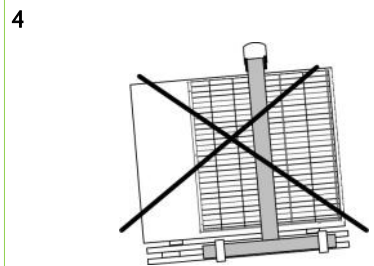
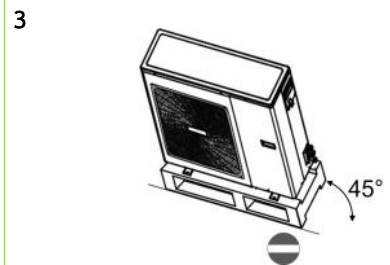
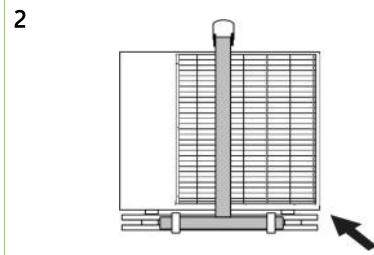
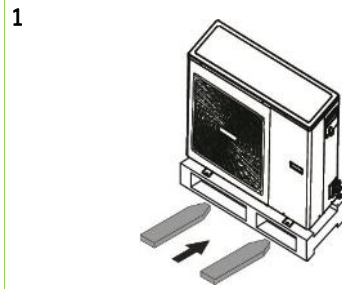

Remove wooden platforms

- Remove the screws (A)

Packing removing

Be careful not to damage the unit.
 Keep packing material out of children's reach it may be dangerous.
 Recycle and dispose of packing material in conformity with local regulations.

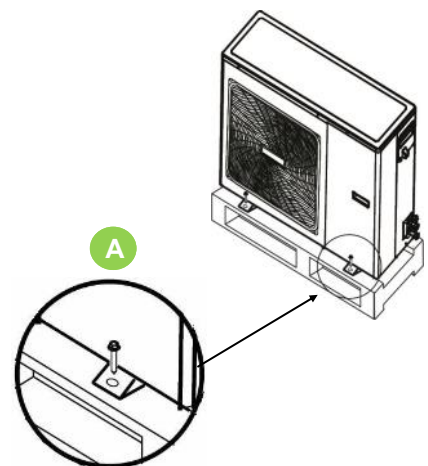



SPHERA EVO Comfort

! To install the individual kits, refer to the installation instructions included with them.

Connections

- | | |
|---|--|
| <ul style="list-style-type: none"> A. Liquid line Ø 3/8" B. Gas line Ø 5/8" C. System outlet D. System return E. DWH return F. DWH outlet G. Aqueduct inlet / storage tank discharge | <ul style="list-style-type: none"> H. System load I. DHW recirculation (option) J. Domestic hot water outlet K. Condensate drain L. Solar system return (option) M. Solar system outlet (option) |
|---|--|

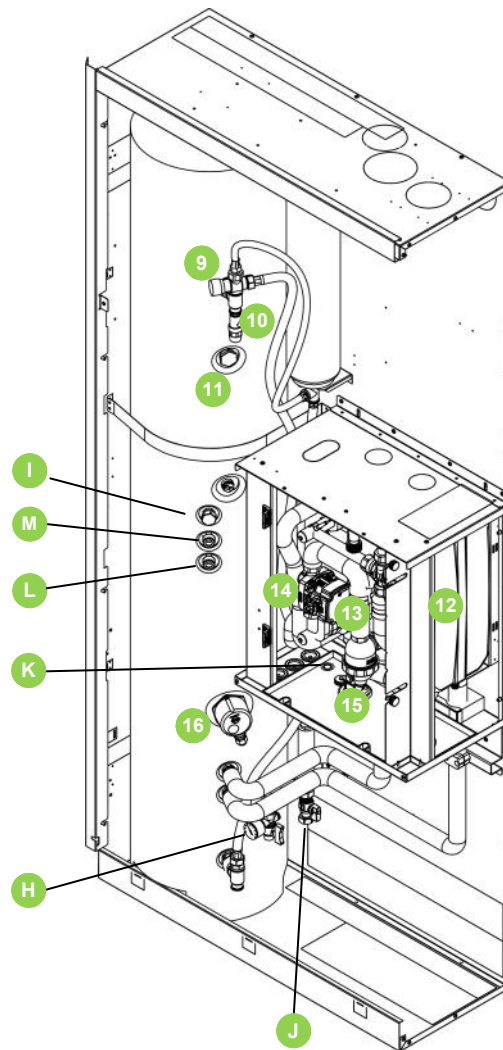
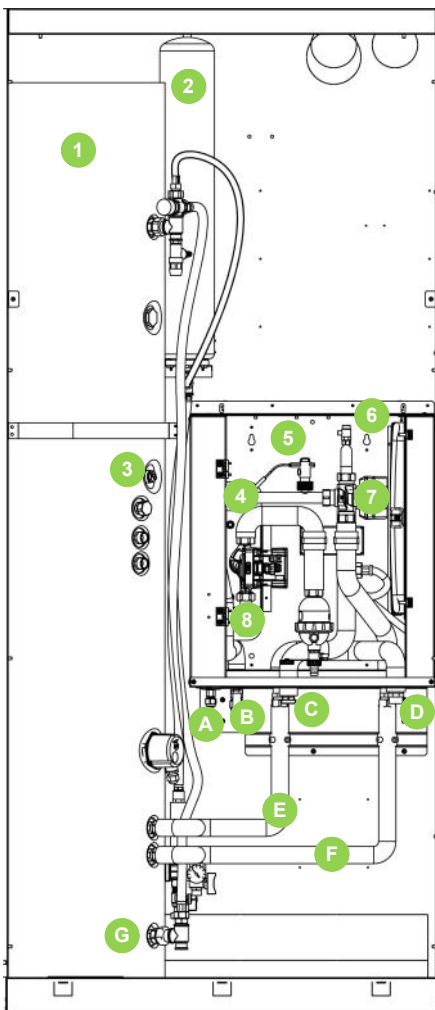

Components

- | | |
|---|---|
| <ul style="list-style-type: none"> 1. Domestic hot water storage 2. Domestic hot water expansion tank 3. Storage tank temperature probe 4. Exchanger outlet probe 5. Flow-switch 6. System vent 7. DHW / System production valve 8. Exchanger inlet probe | <ul style="list-style-type: none"> 9. Thermostatic valve 10. DHW safety valve 11. Anode 12. System expansion vessel 13. Safety valve system (3 bar) 14. System pump 15. Sludge 16. Resistance (2000W) |
|---|---|



If the unit is installed in a closed environment and the total refrigerant charge in the system is ≤ 1.84 kg there are no minimum surface requirements.

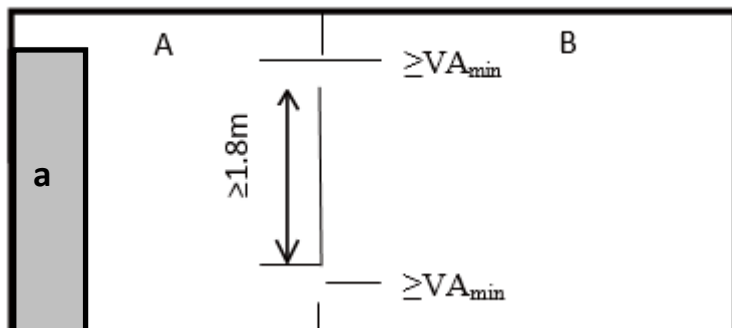

a Indoor unit

A Room where the unit is installed.

B Room adjacent to room A.

Area A+B must be greater than or equal to the minimum surface required in table 2 according to the total charge.

If the total refrigerant charge in the system is > 1.84 kg it is necessary to comply with the minimum surface requirements indicated in the following procedure:

- 1 calculate, based on piping length, the total refrigerant charge (mc)
- 2 calculate area room A (Aroom A)
- 3 calculate, through table 1, the maximum refrigerant charge allowed by room A (mmax)
- 4 **if $mmax \geq mc$ the unit can be installed in room A**

if $mmax \leq mc$

- 1 calculate the area of room B adjacent to room A (Aroom B)
- 2 calculate, through table 2, the minimum total area ($A_{min\ total}$) required for the total refrigerant charge (mc)
- 3 **if (Aroom A + Aroom B) $\geq A_{min\ total}$**
- 4 calculate, through table 3.1 or 3.2, (depending on the power of the outdoor unit), the minimum area of natural ventilation opening between room A and room B
- 5 the unit can be installed in room A if
 - There are 2 ventilation openings (permanently open) between room A and B, 1 at the top and 1 at the bottom.
 - Lower opening: the lower opening must meet the minimum area requirements (V_{Amin}). It must be as close to the floor as possible. If the ventilation opening starts from the floor, the height should be ≥ 20 mm. The lower part of the opening must be less than 100 mm from the floor. At least 50% of the required opening area must be < 200 mm from the floor. The entire area of the opening must be < 300 mm from the floor.
 - Upper opening: the upper opening area must be greater than or equal to the lower opening. The lower part of the upper opening must be at least 1.5 m above the upper part of the lower opening.
 - Outward ventilation openings are NOT considered suitable ventilation openings (the user can lock them when it is cold).
 - **if (Aroom A + Aroom B) $< A_{min\ total}$ call the retailer**



Table 1 - Maximum refrigerant charge allowed in a room: Indoor unit

A _{room} (m ²)	Maximum refrigerant charge in a room (m _{max}) (kg)
	H = 600 mm
1	0,138
2	0,276
3	0,414
4	0,553
5	0,691
6	0,829
7	0,967
8	1,105
9	1,243
10	1,382
11	1,520
12	1,658
13	1,796
14	1,934
15	2,072
16	2,210
17	2,349
18	2,487

- H: This is the release height; the vertical distance in millimetres from the floor to the lowest point of the unit when installed.
- For H values lower than 600 mm, the value of H considered is 600 mm to comply to IEC 60335-2-40:2018 Clause GG 2.
- For intermediate A_{room}, values, consider the value that corresponds to the lower A_{room} value from the table. If A_{room} = 7.5m² consider the value that corresponds to A_{room}= 7m².
- System with total refrigerant charge lower than or equal 1.84 kg are not subjected to any room requirements.



Table 2 - Minimum floor area: Indoor unit

m _c (kg)	Minimum floor area (m ²) (Amintotal)
	H = 600 mm
1,84	13,319
1,86	13,464
1,88	13,608
1,9	13,753
1,92	13,898
1,94	14,043
1,96	14,187
1,98	14,332
2	14,477
2,02	14,622
2,04	14,767
2,06	14,911
2,08	15,056
2,1	15,201
2,12	15,346
2,14	15,490
2,16	15,635
2,18	15,780
2,2	15,925
2,22	16,069
2,24	16,214
2,26	16,359
2,28	16,504
2,3	16,649
2,32	16,793
2,34	16,938
2,36	17,083
2,38	17,228
2,4	17,372
2,42	17,517

- For H values lower than 600 mm, the value of H considered is 600 mm to comply to IEC 60335-2-40:2018 Clause GG 2.
- For intermediate mc value, consider the value that corresponds to the higher mc value from the table. If mc = 2,07 kg consider the value that corresponds to mc= 2,08 kg.
- Systems with total refrigerant charge lower than or equal 1.84 kg are not subjected to any room requirements.
- Charge above 1,84 kg are not allowed in the sizes 2.1 e 3.1.
- Charge above 2,22 kg are not allowed in the sizes 4.1 e 5.1.



Table 3 - Minimum venting opening area for natural ventilation: For units with a power rating of 8 to 10 kW.

m _c [kg]	m _{max} [kg]	Minimum venting opening area (cm ²) (VA _{min})
		H = 600 mm
2,22	0,1	1026
2,22	0,3	928
2,22	0,5	832
2,22	0,7	735
2,22	0,9	638
2,22	1,1	542
2,22	1,3	445
2,22	1,5	348
2,22	1,7	251
2,22	1,9	138
2,22	2,1	52

- For H values lower than 600 mm, the value of H considered is 600 mm to comply to IEC 60335-2-40:2018 Clause GG 1.
- For intermediate m_{max} values, consider the value that corresponds to the higher m_{max} value from the table. If m_{max} = 0.6 kg consider the value that corresponds to m_c = 0.7 kg.

Table 4 - Minimum venting opening area for natural ventilation: For units with a power rating of 12 to 16 kW.

m _c [kg]	m _{max} [kg]	Minimum venting opening area (cm ²)
		H = 600 mm
2,41	0,1	1118
2,41	0,3	1020
2,41	0,5	924
2,41	0,7	827
2,41	0,9	730
2,41	1,1	633
2,41	1,3	537
2,41	1,5	440
2,41	1,7	343
2,41	1,9	247
2,41	2,1	150
2,41	2,3	48

- For H values lower than 600 mm, the value of H considered is 600 mm to comply to IEC 60335-2-40:2018 Clause GG 1.
- For intermediate m_{max} values, consider the value that corresponds to the higher m_{max} value from the table. If m_{max} = 0.6 kg consider the value that corresponds to m_{max} = 0.7 kg.



Positioning

The installation has been implemented by qualified technical personnel only and that the instructions contained in the present manual and the local regulations in force have been adhered to.

Choose the installation place according to the following criteria:

- customer approval
- safe accessible position
- guarantee good unit operation
- enough space for installation and maintenance shall be preserved.
- make sure that there's no obstacle around the unit
- the base surface should to bear the weight of the unit and suitable for installing the unit without increasing noise or vibration
- carry out maintenance operations
- technical spaces requested by the unit
- water connections
- max. distance allowed by the electrical connections
- max. distance allowed by the refrigerating connections
- control points with capacity adequate to the unit weight
- verify that all bearing points are aligned and leveled
- sound levels (TECHNICAL INFORMATION section) external unit

Maximum distance

Refrigerant pipes

Size			2.1 - 5.1
Refrigerant pipe min/max equivalent length	A	m	3 - 30
Maximum refrigerant pipe height difference with outdoor unit higher than indoor unit	B	m	25
Maximum refrigerant pipe height difference with outdoor unit underthan indoor unit.	B	m	25

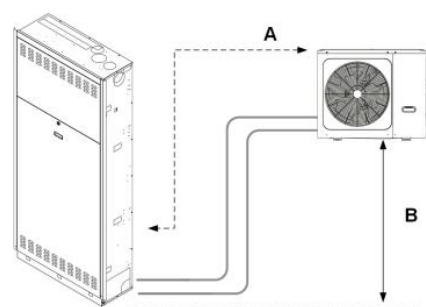



External unit

- Installed EXTERNAL
- in fixed positions

If the unit is installed on a roof or terrace, check the load capacity and the possibility for discharging the condensate.

Installation standards:

- spaces for the air intake/exhaust
- condensate water draining
- install the unit raised from the ground

Prefer places where the unit doesn't disturb the neighbours.

Avoid installations in places subject to flooding

Avoid installations next to bedrooms or windows.

Avoid snow accumulating obstructing for air ejection and suction

A correct circulation of the air is indispensable to guarantee the good working order of the machine.

Avoid therefore:

- obstacles to the airflow;
- exchange difficulties;
- leaves or other foreign bodies that can obstruct the exchange batteries;
- winds that hinder or favour the airflow;
- heat or pollution sources close to the unit (chimneys, extractors etc);
- stratification (cold air that stagnates at the bottom);
- recirculation (expelled air that is sucked in again);
- positioning below the level of the threshold, close to very high walls, attics or in angles that could give rise to stratification or recirculation phenomenons.
- Ignoring the previous indications could:
 - energy efficiency decrease;
 - blocks due to HIGH PRESSURE (in summer) or LOW PRESSURE (in winter).

5 INSTALLATION REQUIREMENTS



- 1 Consider clearances and direction of expelled air. Single unit installation
- 2 Units side by side
- 3 Units in parallel
- 4 Keep the min. distances from the pedestrian areas.
- 5 Avoid installations next to bedrooms or windows. Consider sound emissions
- 6 Provide windbreaks (or similar) in locations with strong winds.
- 7 Avoid snow accumulations on batteries. Install the unit lifted from the ground.

4

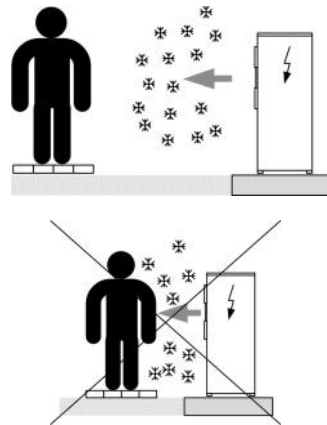

1

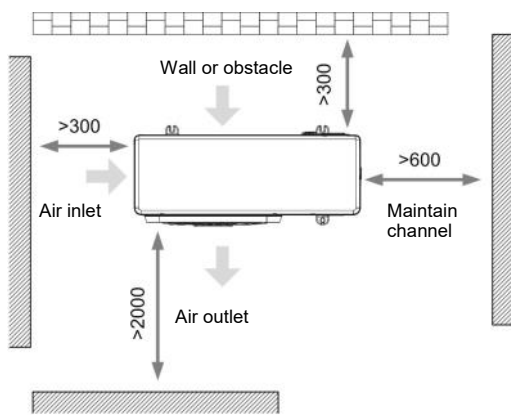

5

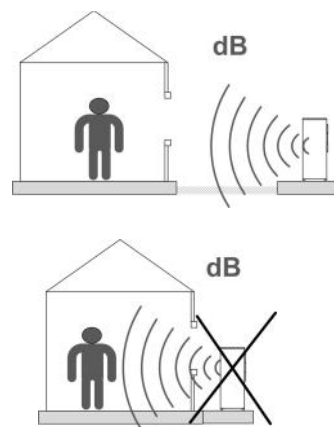

2

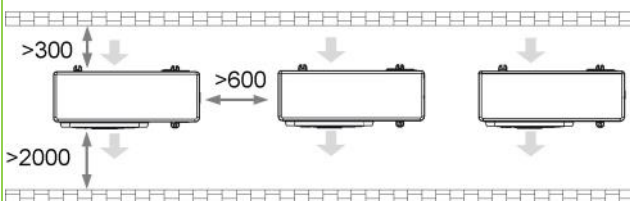

6

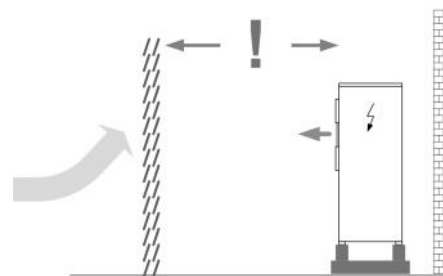

3

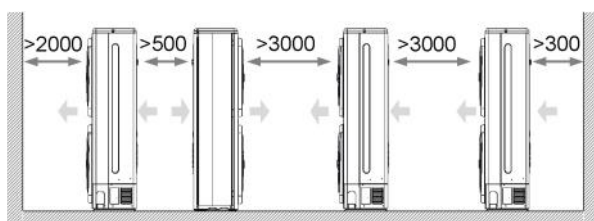

7

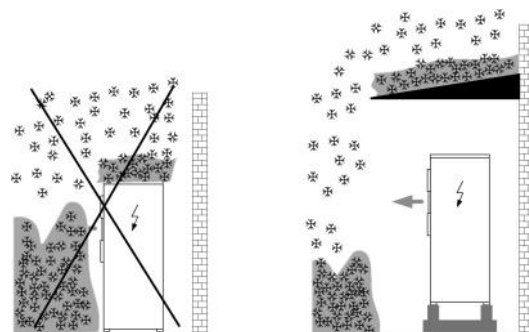



Installation

Check the strength and level of the installation ground so that the unit may not cause any vibrations or noise during its operation.

Prepare four sets each of $\varnothing 10$ Expansion bolts, nuts and washers

NOTE

⇒ Screw in the foundation bolts until their length is 20 mm from the foundation surface.

- A. Floor or roof
- B. Neoprene strip
- C. $\varnothing 10$ Expansion bolt
- D. Concrete support base $h \geq 100\text{mm}$

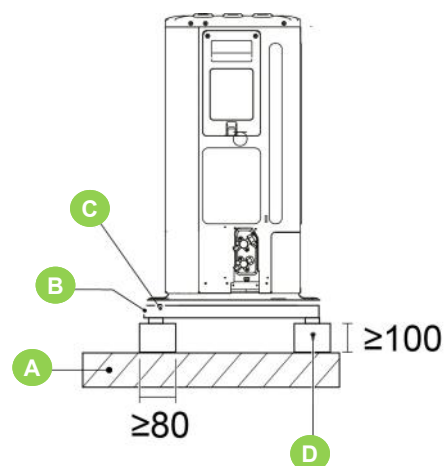

Levelling unit

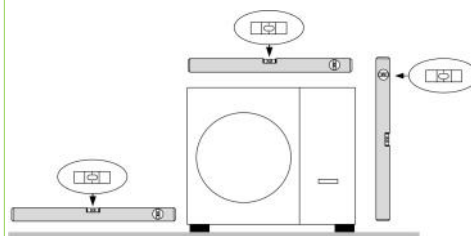

Condensate drain

When a heat pump is running it produces a considerable amount of water due to the defrosting cycles of the external coil.

NOTE

⇒ The condensation must be eliminated in a manner to avoid wetting pedestrian areas.

With extensive very cold outdoor temperatures, condensation could freeze outside the unit blocking the flow and causing a slow build-up of ice; therefore special attention must be paid to eliminating condensation, raising the unit off the ground and evaluating whether antifreeze elements should be installed.

To avoid freezing of the water downstream of the drain lay the tube below the frost line (E).

- A DTX = Condensation collection basin (Accessory separately supplied)
- B Unit support (Customer care)
- C Pipe discharge connection (Customer care)

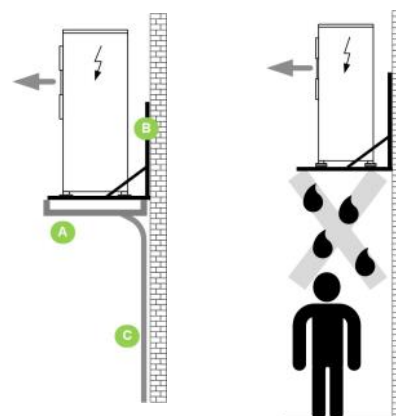

5 INSTALLATION REQUIREMENTS



- A Condensate discharge connection \varnothing 30
- B Frost line
- C Layer of gravel or pebbles to help with condensate drainage
- D This drain hole is covered by rubber plug. If the small drain hole can not meet the drainage requirements, the big drain hole can be used at the same time.

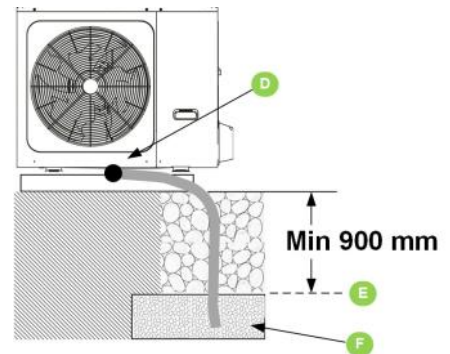

Size 2.1 - 3.1

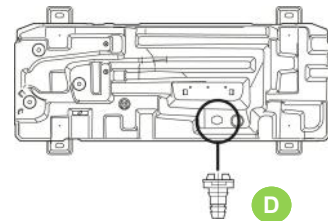

Size 4.1 - 5.1

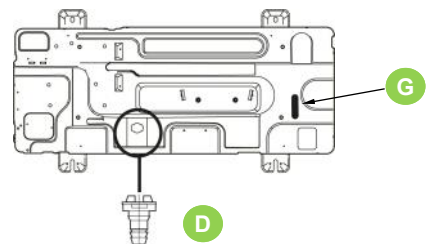



Installation the recessed cabinet / unit

WARNING

- ⇒ *The recessed cabinet can not replace the bearing wall, so it is necessary to consult the building designer to check the ideal place to create the recess in the wall.*
- ⇒ *Creating the recess in the wall it is forbidden to interrupt/ cut pipes, cables, drains of any type, etc..... and especially bearing structures made of reinforced concrete.*

- installed INSIDE or EXTERNAL
- in a place protected from the weather (rain, wind, sunshine and especially freezing temperatures)
- in fixed positions and in bubble level

If is installed on a terrace, check the load capacity and the possibility for discharging the condensate.

Prefer places where the unit doesn't disturb the neighbours.

Avoid installations in places subject to flooding

Avoid installations next to bedrooms or windows.

The spaces can be occupied by objects that must be easily removeable in case of maintenance interventions.

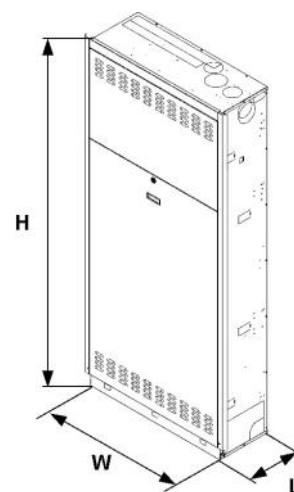

H	W	L
2200	950	350

Consider sound emission

Noise levels could represent an inconvenience if installed in areas that require extreme silence, exsample near bedrooms.

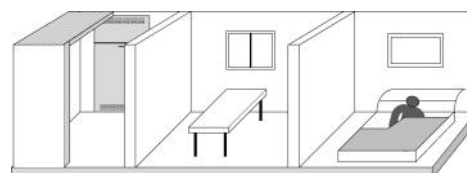
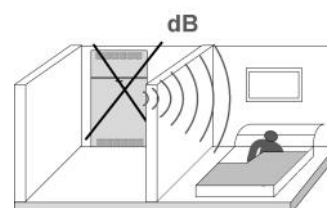

External unit

Avoid installations next to bedrooms or windows.

Consider sound emissions

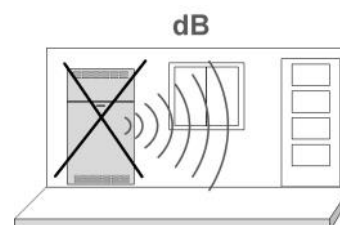



Access to the internal parts

- 1 Panel opening
- 2 Remove the panel
- 3 Remove the screws (A)

4 Remove the panel

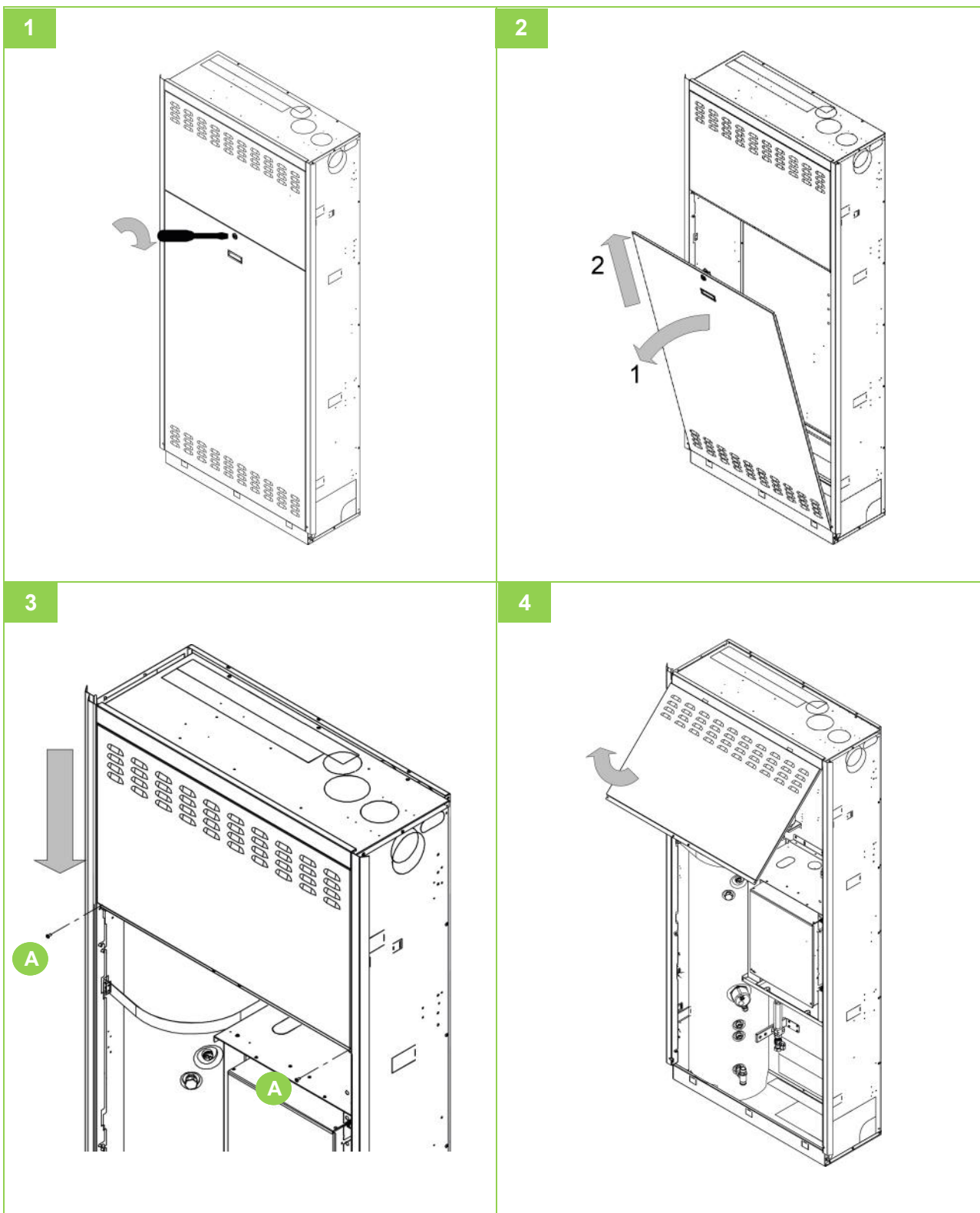



IDROBOX installation

NOTE

⇒ Use hemp, teflon, liquid sealants etc... to seal the threaded connections

Attention!

First install the storage tank (A), see PE instructions

Remove the protective caps (B)

The hydronic unit weighs around 25 kg.

<p>1</p> <p>Install supports C, D, E</p>	<p>2</p> <p>Open the precuts</p>
<p>3</p> <p>Install fitting T on the DHW expansion vessel (F) (max. 6 bar) ATT. The hydronic unit weighs around 45 kg.</p>	<p>4</p> <p>Route the clamps through the tabs (F) to secure the expansion vessels.</p> <p>Electrical panel opening</p>

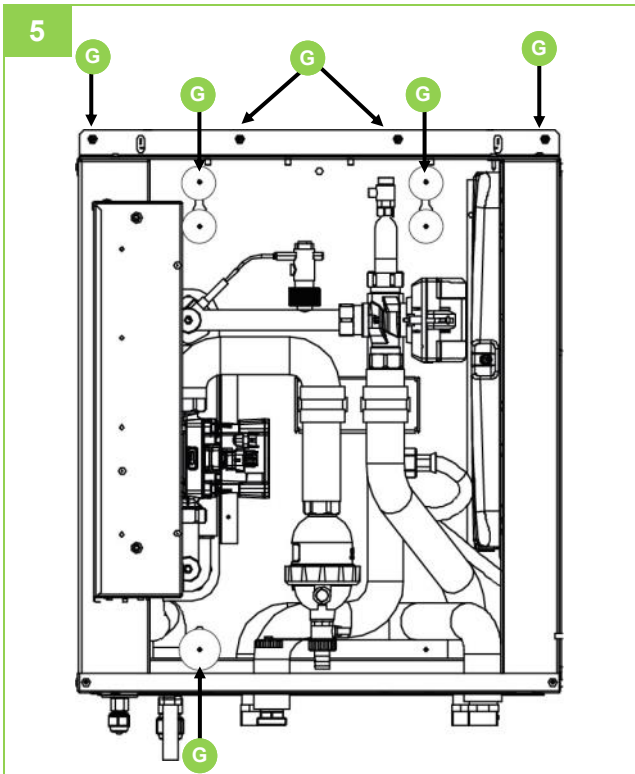

Secure the hydronic module with screws
G - Holes for screws (n°9)

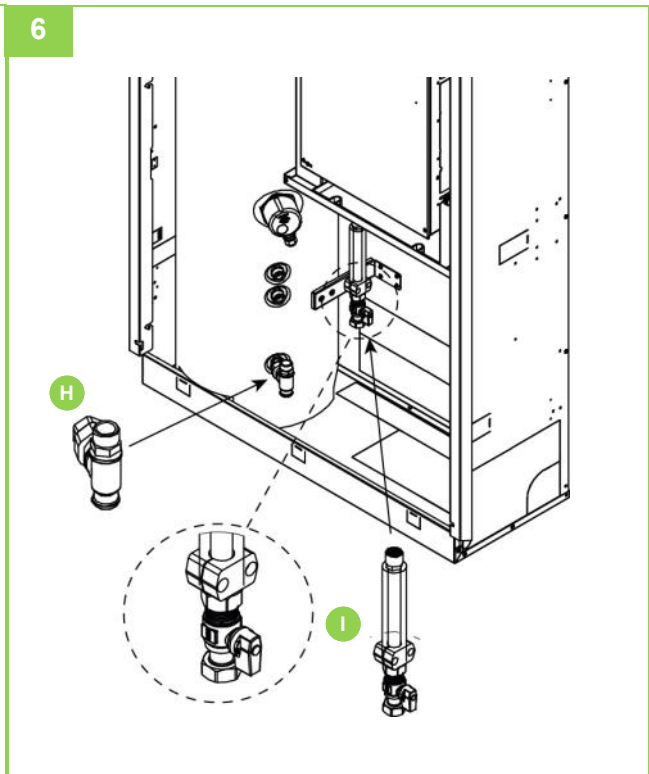

Install fitting (H)
Install pipe (I) + valve + gasket, fix pipe with bracket

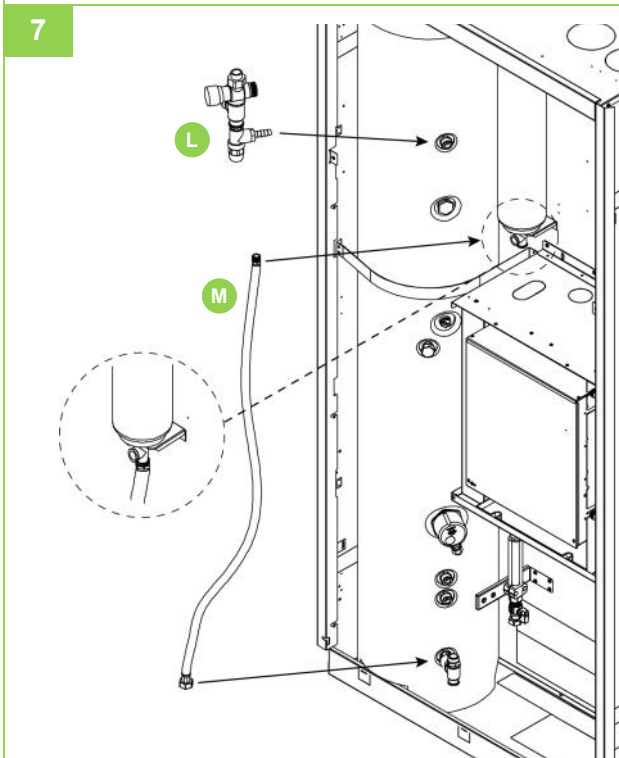

Install thermostatic valve (L) + DHW safety valve + gasket
Install pipe (M) + gaskets

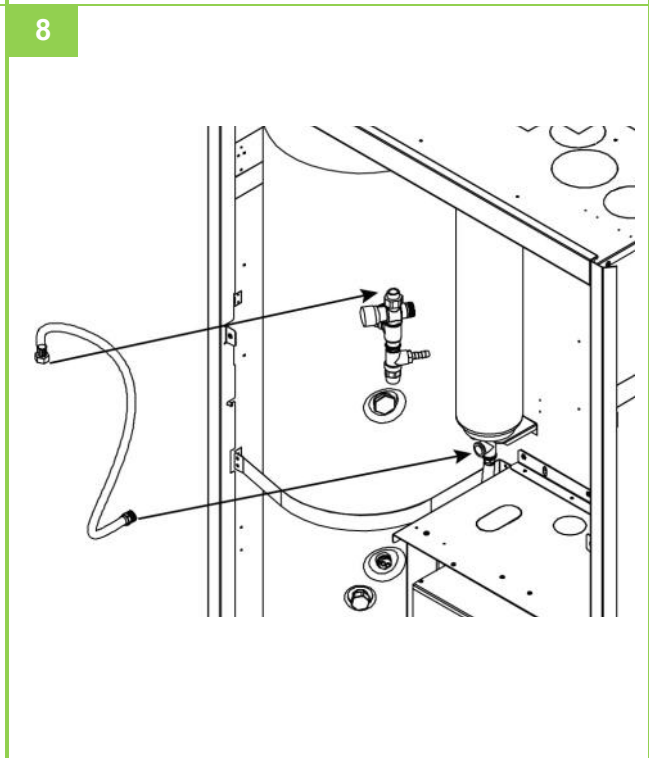

Fix pipe + gaskets

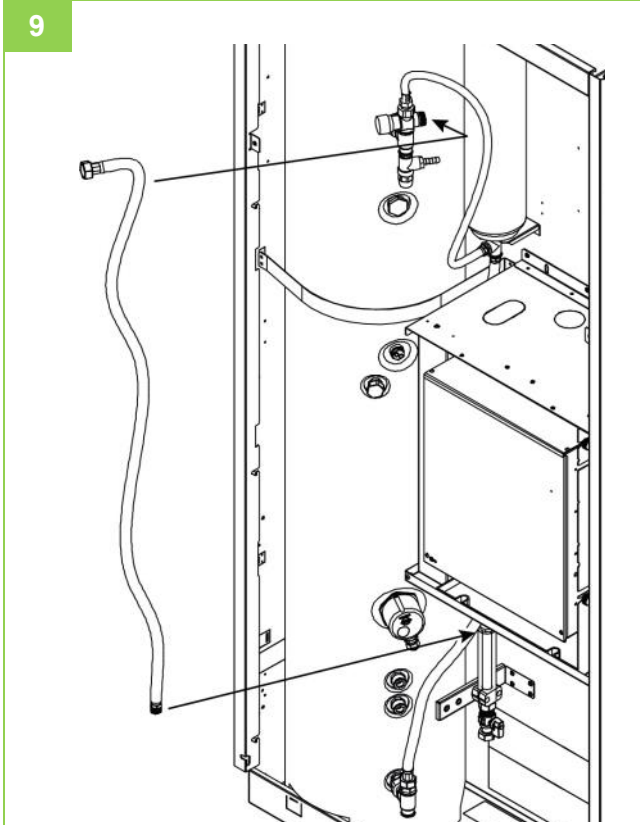

Install ACS pipe + gaskets

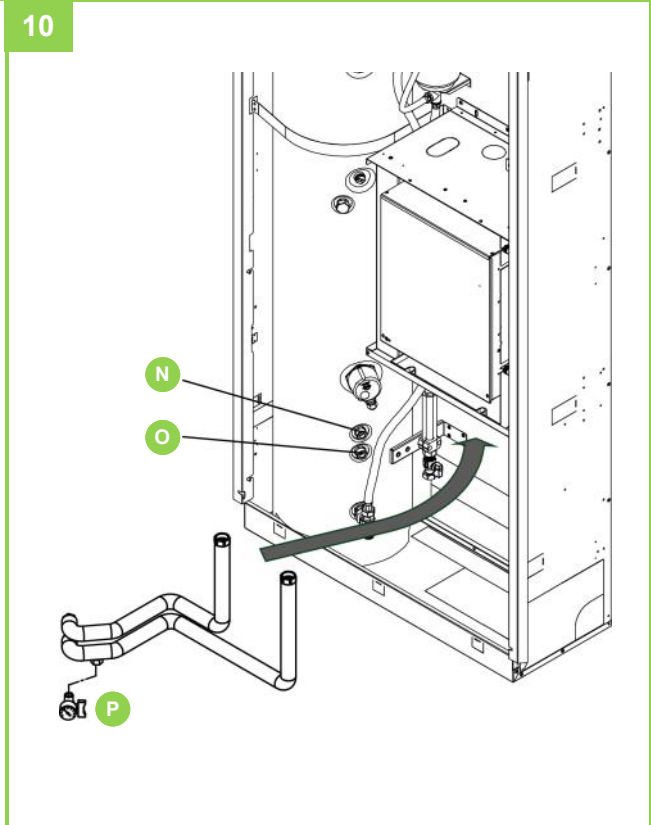

Install pipes + gaskets:
 N - DWH return
 O - DWH outlet
 P - Install valve

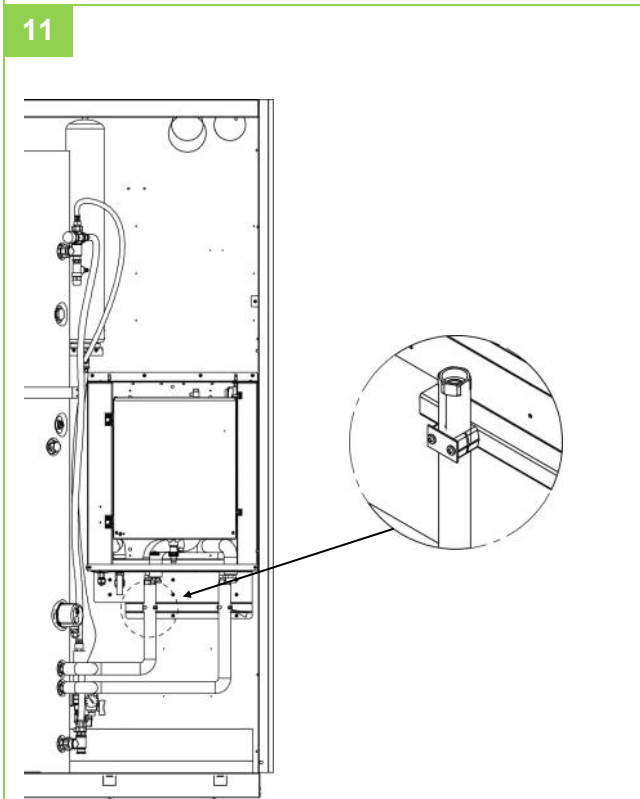

Secure the pipes with the brackets

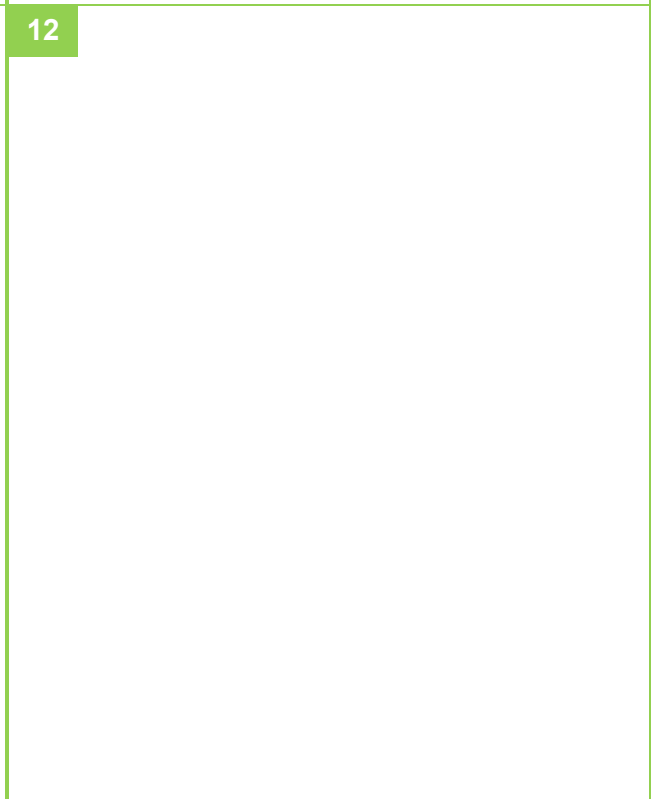



Unit keyboard

The unit control keypad does not function as a room thermostat.

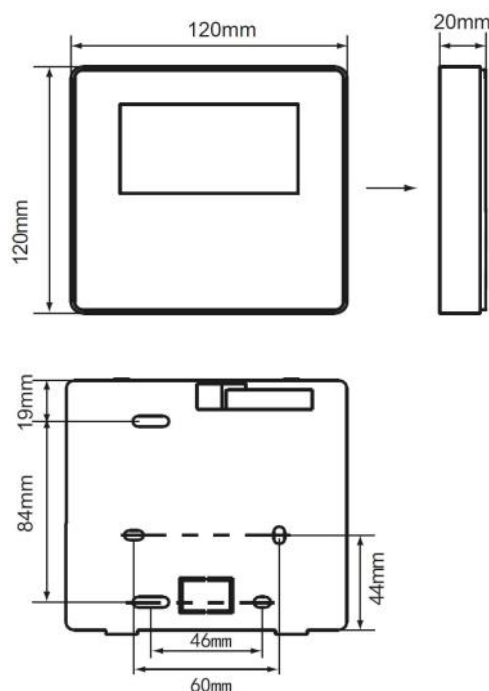

Use straight head screwdriver to insert into the buckling position in the bottom of keyboard, and spin the screwdriver to take down the back cover. (Pay attention to spinning direction, otherwise will damage the back cover!)

Use three GB950-86 M4X20 screws to directly install the back cover on the wall.

Use two M4X25 GB823-88screws to install the back cover on the 86 electrician box, and use one GB950-86 M4X20 screws for fixing on the wall.

Adjust the length of two plastic screw bars in the accessory to be standard length from the electrical box screw bar to the wall. Make sure when install the screw bar to the wall, make it as flat as the wall.

Use cross head screws to fix the keyboard bottom cover in the wall through the screw bar. Make sure the keyboard bottom cover is on the same level after installation, and then install the keyboard back to the bottom cover.

Over fasten the screw will lead to deformation of back cover.

5 INSTALLATION REQUIREMENTS



Buckling position

Back cover

Front cover

Straight head screwdriver

Foro per la vite installato a parete, utilizzarne tre GB950-86 M4X20

Screw hole fixed on the wall, use one GB950-86 M4X20

A - Screw hole installed on 86 Electrician box, use two M4X25 GB823-88

Back cover

Signal switching wires

Cutting place of left-down side wire outlet

Left down side wire outlet

Electrician box

44mm

60mm

Wiring hole

Wall hole and wiring hole

Diameter 8-10

After adjusting the front cover and then buckle the front cover; avoid clamping the communication switching wire during installation.

Sensor can not be affected with damp.

Avoid the water enter into the wired remote controller, use trap and putty to seal the connectors of wires during wiring installation.

B - Trap

C - Putty

✓ X X X



Hydraulic connection schema

Make sure that the safety devices are installed on the DHW circuit, safety and thermostatic valve (provided by the client) the latter when the anti-Legionella function is enabled.

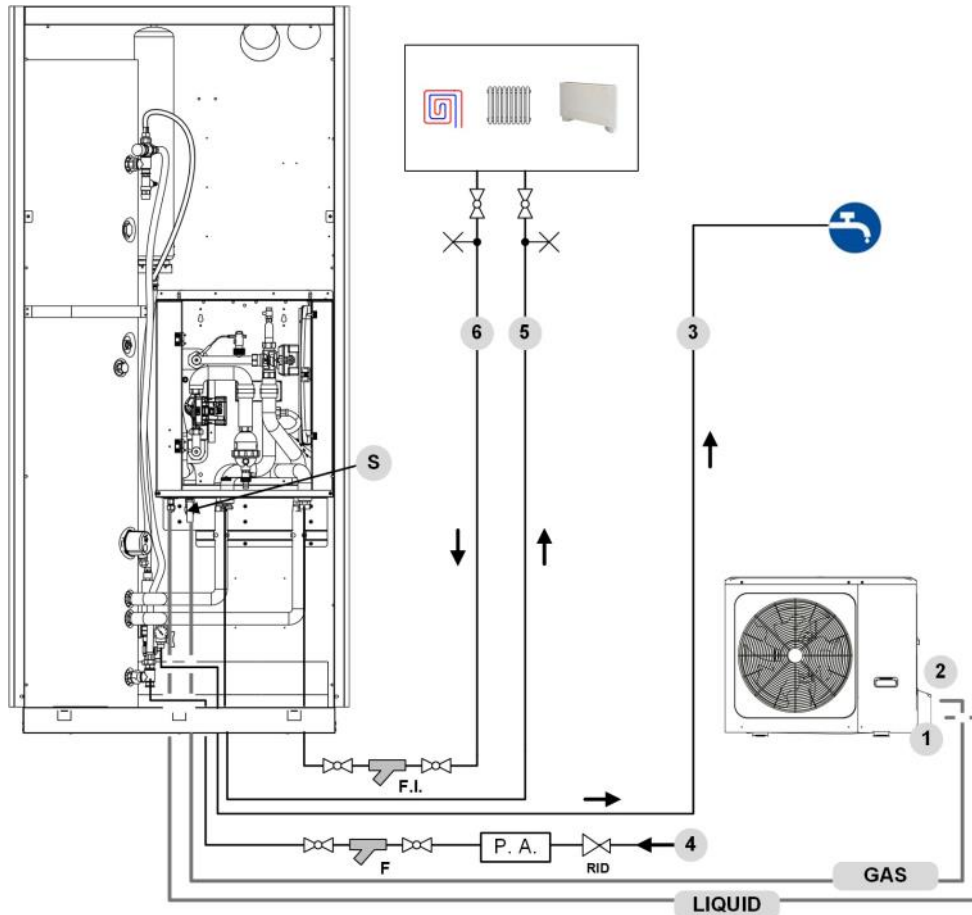

Indicative plumbing diagram

The system components must be defined by Designer and Installer (ex. expansion tanks, vents, taps, calibration/safety valves etc.)

1	Refrigerant line \varnothing 3/8" (liquid)
2	Refrigerant line \varnothing 5/8" (gas)
3	Domestic hot water output \varnothing 3/4"
4	Aqueduct input \varnothing 3/4"
5	System water supply \varnothing 1"
6	System water return \varnothing 1"

S	Condensate drain \varnothing 18mm
VR	check valve *
F.I.	System filter *
F	Water filter (supplied as standard)
P.A.	Descaler protection*
RID	Pressure reducing valve*
	Vent*
	Cut-off valves*

* provided by the Customer



In the tightening operations always use the wrench and backup wrench.



An air bleed valve

Install the highest points of tubes in a way that the air can escape from the circuit.

Water filter (supplied as standard)

The filter is extremely important: it helps to lockout any impurities in the water and avoid clogging the system and heat exchanger. It must be installed immediately at the entrance to the water mains, in a position that is easily accessible for cleaning.

The filter should never be re-moved.

Check for clogging from time to time

System filter (provided by the client)

Must be installed on the system return of the STD booster, and also on the 2nd booster if present.

The filter must never be removed.

Check for clogging from time to time.

Connecting the indoor unit drains

Note

⇒ Any anti-freeze liquid contained in the system should not be discharged freely as it is a pollutant.

⇒ It must be collected and reused.

- Connect an Ø18mm pipe to the connection (D)
Secure the pipe using a pipe clamp and place in an area suitable the drain accumulation / drain pit (E)
- Connect a Ø12mm pipe to the ACS safety valve (A) and to the "T" connection (C) and to the system safety valve (B).
Secure the pipe using a pipe clamp and place in an area suitable the drain accumulation / drain pit (E)
- At the end of the works check the correct outflow of the condensation, pouring water in a bowl.

Inside the unit there is a safety valve (3 bar on the installation circuit) and one to the DHW outlet (6 bar on the DHW circuit) that must be connected to a suitable drain, otherwise if valves intervened and flood the rooms, the heat pump manufacturer will not be responsible.

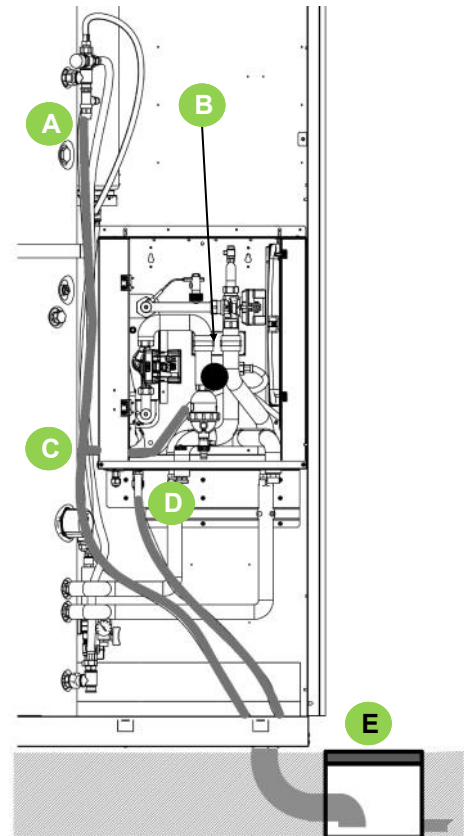
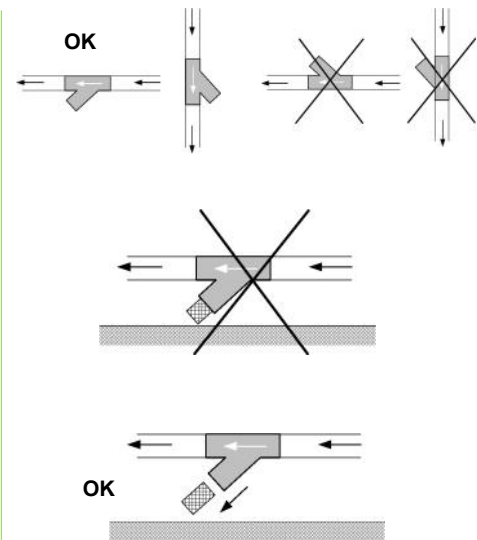

A	DHW safety valve (6 bar)
B	System safety valve : discharge in pressure (3 bar)
C	Connection " T " + safety valve di- scharge A+B Ø 12mm
D	Condensate drain connection Ø 18mm
E	Drain accumulation / drain pit



Note

⇒ Fill the storage tank (DHW) only during the unit start-up. If the house is not immediately lived, or the unit is turned off for long periods, empty the storage tank to avoid the stagnation of the water, or with temperatures close to 0°C the risk of freeze.

Water features

Note

⇒ Circulators function well exclusively with clean and high-quality tap water.

The most frequent factors that can affect circulators and the system are oxygen, limescale, sludge, acidity level and other substances (including chlorides and minerals).

In addition to the quality of water, installation also plays an important role. The heating system must be airtight. Choose materials that are not sensitive to oxygen diffusion (risk of corrosion...).

Characteristics of the water

- compliant with local regulations
- Langelier Index (LI) between 0 and +0.4
- within the limits indicated in the chart

Water quality must be checked by qualified personnel.

Hardness

If the water is hard, install a system suitable to preserve the unit from harmful deposits and limestone formation.

If necessary, install a water softener to reduce water hardness

Cleanliness

Before connecting the water to the unit, clean the system thoroughly with specific products effective to remove residues or impurities that may affect functioning. Existing systems must be free from sludge and contaminants and protected against build-ups.

New systems

In case of new installations, it is essential to wash the entire installation (with the circulator uninstalled) before commissioning the central installation. This removes residues of the installation process (welding, waste, joint products...) and preservatives (including mineral oil). The system must then be filled with clean high-quality tap water.

Existing systems

If a new boiler or heat pump is installed on an existing heating system, the system must be rinsed to avoid the presence of particles, sludge and waste. The system must be drained before installing the new unit. Dirt can be removed only with a suitable water flow. Each section must then be washed separately. Particular attention must also be paid to “blind spots” where a lot of dirt can accumulate due to the reduced water flow. The system must then be filled with clean high-quality tap water. If, after rinsing, the quality of the water is still unsuitable, a few measures must be taken to avoid problems. An option to remove pollutants is to install a filter. Various types of filters are

Water component for corrosion limit on Copper

PH	7,5 ÷ 9,0	
SO ₄ ⁻	< 100	
HCO ₃ ⁻ / SO ₄ ⁻	> 1	
Total Hardness	8 ÷ 15	°f
Cl ⁻	< 50	ppm
PO ₄ ³⁻	< 2,0	ppm
NH ₃	< 0,5	ppm
Free Chlorine	< 0,5	ppm
Fe ₃ ⁺	< 0,5	ppm
Mn ⁺⁺	< 0,05	ppm
CO ₂	< 50	ppm
H ₂ S	< 50	ppb
Temperature	< 65	°C
Oxygen content	< 0,1	ppm
Sand	10 mg/L 0.1 to 0.7mm max	
Ferrite hydroxide Fe ₃ O ₄ (black)	Dose < 7.5 mg/L 50% of mass with diameter < 10	
Iron oxide Fe ₂ O ₃ (red)	Dose < 7.5mg/L Diameter < 1 µm	



available. A mesh filter is designed to catch large dirt particles. This filter is usually placed in the part with the larger flow. A tissue filter is designed to catch the finer particles.

Exclusions

The warranty does not cover damage formed by limestone, deposits and impurities deriving from the water supply and/or by the malfunctioning of the system cleaning system.

Note

⇒ *If necessary, fit a water softener to reduce water hardness.*

Risk of frost

Note

⇒ *When the outside temperature gets close to 0°C, the water in the pipes and unit may freeze.*

⇒ *Frost may determine irreversible damage to the unit.*

⇒ *Frost damage is not covered by the warranty.*

If the unit or hydraulic connections are subject to temperatures close to 0°C:

- mix water with glycol, or
- safeguard the pipes with heating cables placed under the insulation, or
- empty the system in cases of long non-use

Anti-freeze solutions

Consider that the use of anti-freeze solution determines an increase in a pressure drop.

Make sure that the glycol type utilized is inhibited (not corrosive) and compatible with the water circuit components.

Do not use different glycol mixture (i.e. ethylene with propylene).



Domestic hot water tank charge

Maximum DWH system pressure 6 bar

DWH safety valve setting 6 bar

- 1 System general switch = OFF.
- 2 Close the DWH drain valve (A)
- 3 Start the filling opening the water loading valve DWH (B)
- 4 Open the valve (C) DHW outlet
- 5 Open the hot water taps (bathroom and kitchen)
- 6 Close the taps when water starts to come out.
- 7 Check the hydraulic seal of the joints.

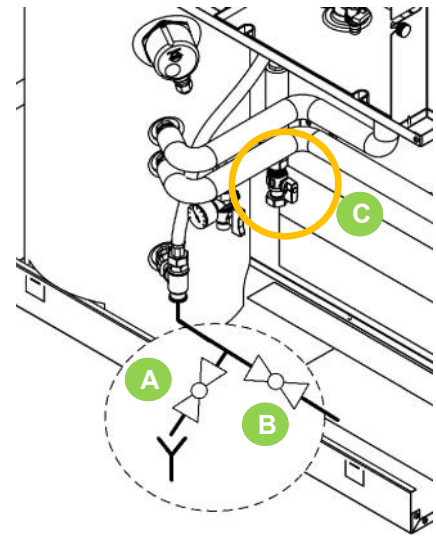

System charge heating/cooling

- 1 Switch ON the unit
- 2 From the keyboard put ON the domestic hot water mode and wait until the lever of the 3 way valve goes to the right,
- 3 Switch OFF the unit
- 4 Press on the lever and move it to the centre until it locks
- 5 Start the filling opening the tap (B)
- 6 Open the tap (D) system load
- 7 Open the taps (E) if present (system)
- 8 Open the vent valves of the terminals or radiators
- 9 Close them when water begins to exit; continue the charging until the pressure intended for the system (max.3 bar).
- 10 Check the hydraulic seal of the joints.
 - Once the process is finished, the valve goes to heating/cooling mode automatically when will be power on.
 - Repeat the operation after the unit has operated for a number of hours and periodically control the system pressure. Reintegration is carried out when the unit is off (pump OFF).

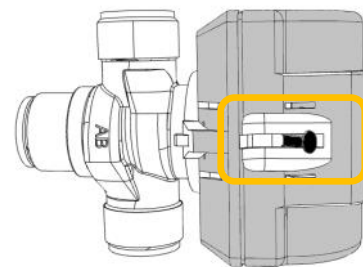

2



4

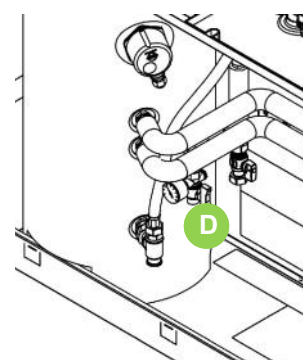
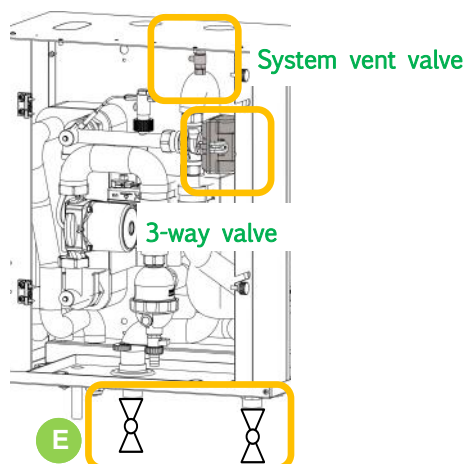

ATTENTION

During installation, use and maintenance operations, the motor must NOT be removed.

In case of extraordinary maintenance see chapter MAINTENANCE



Refrigerant lines

Unit is designed to ensure the best comfort and energy efficiency levels. To maintain these high values is necessary to consider the system details that could adversely affect on performances.

NOTE

In particular:

- ⇒ *the length of the refrigerant piping should be as small as possible ;*
- ⇒ *to realize a path of the pipes as straight as possible by limiting the presence of curves;*
- ⇒ *properly insulate pipes;*
- ⇒ *properly load the refrigerant system.*

NOTE

- ⇒ *An incorrect sizing can cause damage to the compressor or variations in the cooling capacity .*

When cut-off parts (solenoid valves, taps etc) are installed pay attention to the possible formation of traps for the refrigerant, meaning closed zones up or downstream in which the refrigerant is unable to expand freely.

With an increase in temperature under these circumstances (exposure to the sun, ducting close to heat sources etc) the expansion of the trapped gas could cause an explosion in the refrigerating ducting. Evaluate the possibility of installing a safety valve especially in the ducting of the liquid which is exposed to the most risk.

The operations must be carried out by an expert refrigerationist .

Avoid curves with a too small curving radius.

Avoid squashing the pipes.

Provide anchoring rods to support the ducting (the weight must not be on the unit).

The rods must allow the thermal dilation of the ducting.

Place anti-vibrating material between the rods and the ducting to avoid the transmission of vibrations.

Clean with nitrogen or dry air before attaching the ducting to the two units.

The internal unit and the heat exchanger must be connected with refrigerating ducting suitable for the refrigerant used and covered with thermal insulation.



Warning:
Fire hazard
Flammable materials

Before starting light operations:

safety warnings for
operations on units
containing R32



Ducting

Pressure Equipment Directive

This unit is a subset: to operate it has to be combined to another unit.

It is an installer responsibility :

- follow the PED Directive and to the national regulations of PED Directive realization
- consider the insertion of any additional security devices
- check the safety device operation
- write on the serial label number the amount of total refrigerant
- issue the Declaration of conformity
- inform the user of the need to carry out regular checks

NOTE

⇒ Use only copper pipes for refrigeration, specifications for R32

The installation of the pipes may affect the level of noise in the system:

- install flexible joints between the unit and the pipes
- Install antivibration material between the brackets and the pipes so as to prevent the transmission of vibrations
- avoid the passage in particularly silent environments

Pipes must be clean.

Plug the ends of the pipe prior to passing it through a hole in the wall (1).

Do not place the ends of pipes which have not been plugged or closed with tape directly on the ground (2).

If the installation of the pipes is not to be completed within the next day or for a long period of time, braze the ends of the pipes and introduce nitrogen oxide via a Schrader valve access joint to avoid the formation of humidity and the contamination of the particles.



Size			2.1 - 5.1
Refrigerant pipe min/max equivalent length	A	m	3 - 30
Maximum refrigerant pipe height difference with outdoor unit higher than indoors unit	B	m	25
Maximum refrigerant pipe height difference with outdoor unit underthan indoor unit.	B	m	25

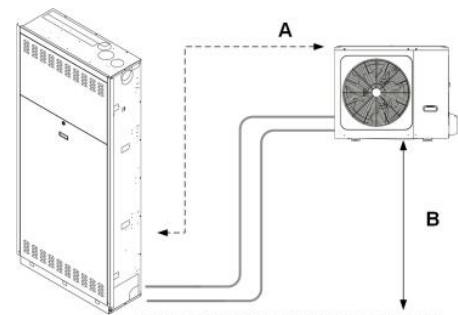

Equivalent length of the lines (metres) = Effective length (metres) + (Q.ty of curves x K)

Consider K=0.3 m for wide radius 90° curves;

Consider K=0.5 m for standard 90° elbow curves









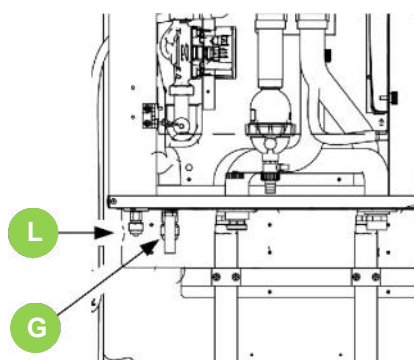
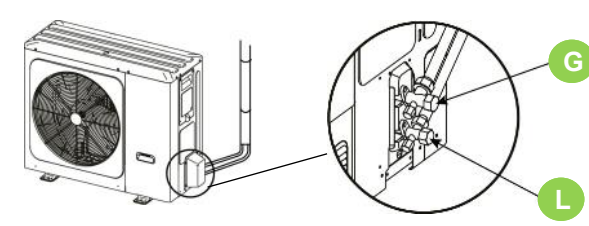

Internal unit

Before attaching the ducting to the two units, clean with dry air or nitrogen.

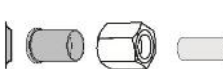
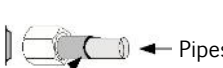
Type of pipes		
Size .	2.1 - 3.1	4.1 - 5.1
Liquid Ø external	1/4" (6,3mm)	3/8" (9,5mm)
Gas Ø external	5/8" (15,9mm)	5/8" (15,9mm)
Min. thickness gas	0,8 mm	
Min. thickness liquid	0,8 mm	

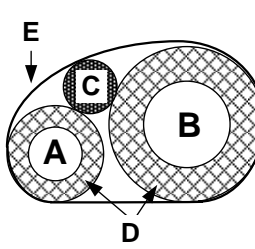
Refrigerating couplings

<div style="background-color: #e0f0e0; padding: 5px; margin-bottom: 5px;">1 Internal unit</div> 	<div style="background-color: #e0f0e0; padding: 5px; margin-bottom: 5px;">2 External unit</div> 																		
<table border="1" style="width: 100%; border-collapse: collapse;"> <tr> <td style="width: 30px; text-align: center;">G</td> <td>Gas line</td> </tr> <tr> <td style="text-align: center;">L</td> <td>Liquid line</td> </tr> </table>	G	Gas line	L	Liquid line	<table border="1" style="width: 100%; border-collapse: collapse;"> <tr> <td style="width: 30px; text-align: center;">G</td> <td>Gas line</td> </tr> <tr> <td style="text-align: center;">L</td> <td>Liquid line</td> </tr> </table>	G	Gas line	L	Liquid line										
G	Gas line																		
L	Liquid line																		
G	Gas line																		
L	Liquid line																		
<div style="background-color: #e0f0e0; padding: 5px; margin-bottom: 5px;">3</div> <p>Use the components supplied with the unit or perform flaring to make the connections.</p> <table border="1" style="width: 100%; border-collapse: collapse;"> <thead> <tr> <th colspan="2">Refrigerating line fittings</th> </tr> <tr> <th>Size</th> <th>2.1 - 5.1</th> </tr> </thead> <tbody> <tr> <td style="text-align: center;"></td> <td>2x5/8" Gas line 2x3/8" Liquid line</td> </tr> <tr> <td style="text-align: center;"></td> <td>2x5/8" Gas line 2x3/8" Liquid line</td> </tr> </tbody> </table> <div style="margin-top: 10px;">  Reduction 10-6 for outdoor unit size 2.1-3.1 </div> <div style="margin-top: 10px;">  </div> <div style="margin-top: 10px;">  ← Pipes supplied by the customer </div> <p>Welding points</p>	Refrigerating line fittings		Size	2.1 - 5.1		2x5/8" Gas line 2x3/8" Liquid line		2x5/8" Gas line 2x3/8" Liquid line	<div style="background-color: #e0f0e0; padding: 5px; margin-bottom: 5px;">4</div> <p>Insulate pipes. Use insulation with resistance $t = 120 \text{ }^\circ\text{C}$ with a thickness of at least 13 mm.</p>  <table border="1" style="width: 100%; border-collapse: collapse; margin-top: 10px;"> <tr> <td style="width: 30px; text-align: center;">A</td> <td>Liquid ducting</td> </tr> <tr> <td style="text-align: center;">B</td> <td>Gas ducting</td> </tr> <tr> <td style="text-align: center;">C</td> <td>Electric cables</td> </tr> <tr> <td style="text-align: center;">D</td> <td>Insulation</td> </tr> <tr> <td style="text-align: center;">E</td> <td>Sheath - sticky tape</td> </tr> </table>	A	Liquid ducting	B	Gas ducting	C	Electric cables	D	Insulation	E	Sheath - sticky tape
Refrigerating line fittings																			
Size	2.1 - 5.1																		
	2x5/8" Gas line 2x3/8" Liquid line																		
	2x5/8" Gas line 2x3/8" Liquid line																		
A	Liquid ducting																		
B	Gas ducting																		
C	Electric cables																		
D	Insulation																		
E	Sheath - sticky tape																		



internal unit vacuum operation

is delivered with charged refrigerator circuits in the following manner:

External unit charged with refrigerant			
Size		2.1 - 3.1	4.1 - 5.1
R32	kg	1,50	1,65
* total charge	t CO2-eq	1,02	1,11

NOTE

⇒ The refrigerant charge present in the external unit is sufficient up to 15 meters of distance between the 2 units.

Lengths of ducting exceeding 15 metres		
Further refill for distance exceeding 15 metres		
Size	2.1 - 3.1	4.1 - 5.1
kg/m	0,02	0,038

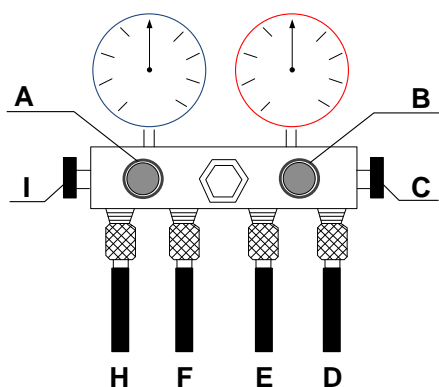

A	VAC vacuum gauge cock
B	REF refrigerant cock
C	HIGH high pressure cock
D	liquid high pressure pump
E	Refrigerant pipe
F	Vacuum pump pipe
H	Low pressure pipe
I	LOW low pressure cock



After having completed the refrigerating connections the sealing of the refrigerating circuit must be checked:

- maintain close the indoor unit cocks **1** and **2**
- connect pipes **D** and **H** to cocks **1** and **2**
- close cocks **A**, **B**, **C** and **I**
- connect **E** to the nitrogen cylinder
- open cocks **C** and **I**
- perform the tightness test
- **Mode 1:** open cock **B**, pressurize the circuit up to 45 bar (see the label) and wait few hours.
- **Mode 2:** open cock **B**, pressurize the circuit up to 65 bar (as according to UNI-EN 378-2 2009:PS x 1,43 law)
- spray using a leak detector spray cocks and pipes and check if bubbles are present (gas leaks)
- if everything is OK, proceed
- discharge the nitrogen from the unit

- connect **F** to the vacuum pump
- open cocks **A**, **C** and **I**
- start the vacuum pump
- in optimal conditions, 15-60 minutes are required to create the vacuum. In the event of high moisture content in the piping or the temperature is $< 20\text{ }^{\circ}\text{C}$, a few hours may be required
- reach the lowest value (approximately 1 mbar = 100 Pa.)
- close cock **A**
- turn off the pump
- overlap the red pointer of the vacuum gauge to the black one
- check the vacuum gauge to ensure that the pressure does not rise, for a few minutes
- if it rises, repeat the procedure
- if everything is OK, proceed

- connect **E** to the coolant cylinder
- open cock **B** to charge the coolant (see table "additional energy exchanger charge")
- close cocks **B**, **C** and **I**
- disconnect pipes **D** and **H** and cocks **1** and **2**

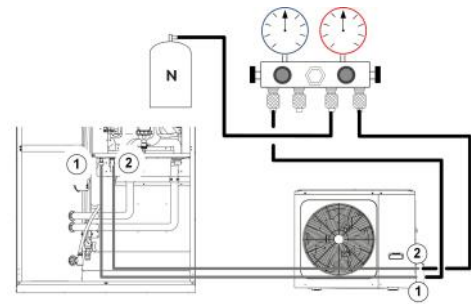

1	Liquid line
2	Gas line

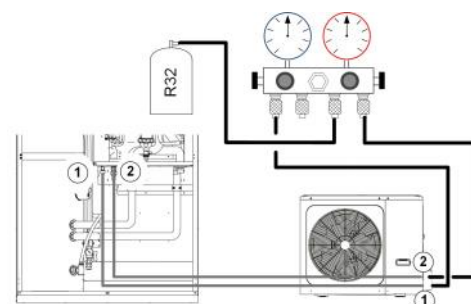
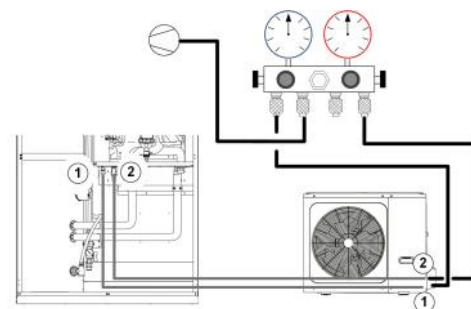



The characteristics of the lines must be determined by specialized personnel able to design electrical installations in compliance with regulations in force.

The protective equipment of the unit supply line must be able to shut-off the presumed short circuit current, which value must be determined in accordance with the system features.

The power cable and protection cable section must be defined in accordance with the characteristics of the protections adopted.

All electrical operations should be performed by trained personnel having the requirements envisaged by the regulations in force and informed about the risks relevant to these activities.

Operate in compliance with safety regulations in force.

Electric data

The serial number label reports the unit's specific electrical data, electrical accessories included.

The electrical data indicated in the technical bulletin and in the manual refer to the standard unit, accessories excluded.

The label reports the indications envisaged by regulations, in particular:

Voltage

F.L.A.: full load ampere, absorbed current at maximum admitted conditions

F.L.I.: full load input, full load power input at max. admissible condition

Electrical wiring diagram No.

Connections

Refer to the unit's electrical diagram (the number of the diagram is shown on the serial number label)

Verify that the electrical supply has characteristics conforming to the data shown on the serial number label.

Before starting work, ensure the unit is isolated, unable to be turned on and a safety sign used.

Ensure correct earth connection.

Ensure cables are suitably protected.

Before powering the unit, make sure that all the protections that were removed during the electrical connection work have been restored.



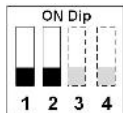
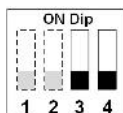

Dip-switch settings

S1			
DIP switch	ON=1	OFF=0	Factory configuration
1/2	0/0= IBH 0/1= reserved 1/0= reserved		
3/4	0/0= without IBH and AHS 0/1= with AHS for heating mode 1/0= with IBH 1/1= with AHS for heating mode and DHW		

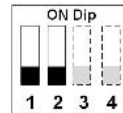
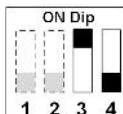
S2			
DIP switch	ON=1	OFF=0	Factory configuration
1	After 24 hours Pump_o stops	After 24 hours Pump_o starts again	
2	Without TBH	With TBH	
*3/4	0/0= variable speed pump (max head: 7,5m) 0/1= constant speed (reserved) 1/0= variable speed pump (max head: 10,5m) 1/1= variable speed pump (max head: 9,0m (reserved))		

*Dip switch 3 = not modifiable, factory setting only.

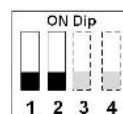
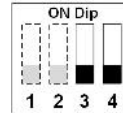
S4			
DIP switch	ON=1	OFF=0	Factory configuration
1	Reserved	Reserved	
2	With IBH for DHW mode	Without IBH for DHW mode	
3/4	Reserved	Reserved	

Temp sensor code	Property value
T2 / T2B	$B_{25/50} = 4100K, R_{25^{\circ}C} = 10k \Omega$
T1 / TW_out TW_in/T5/T1B	$B_{0/100} = 3970K, R_{50^{\circ}C} = 17.6k \Omega$



1 zone system

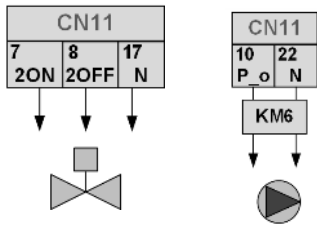
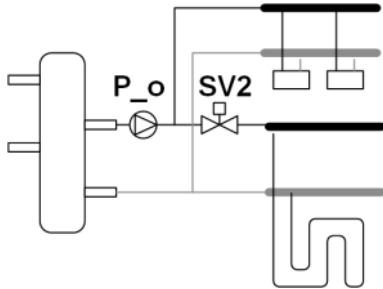

counter for components with absorption greater than 0.2A

2 mixed zone system

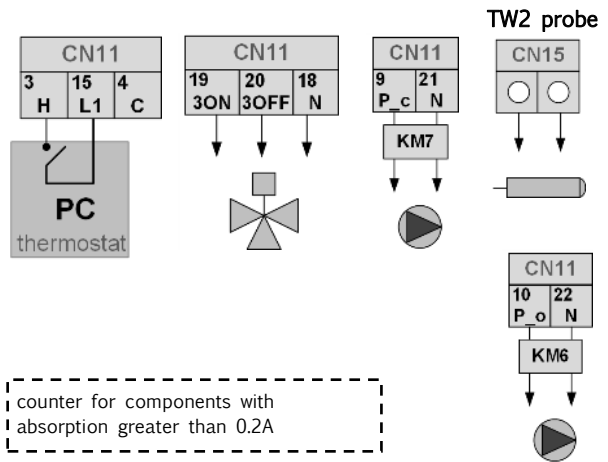
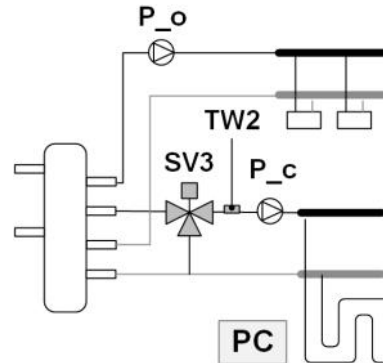

counter for components with absorption greater than 0.2A

Solar

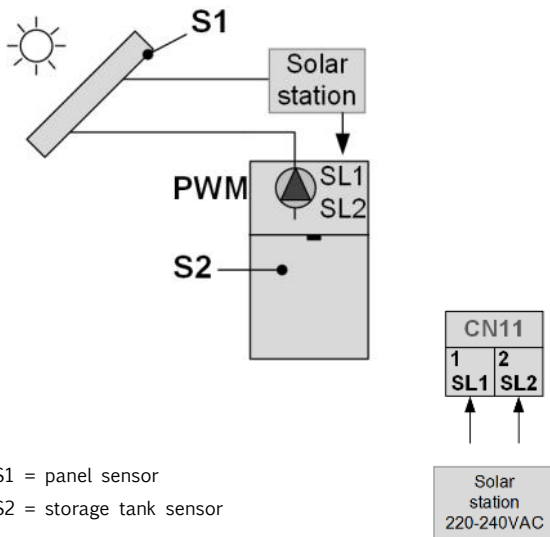

S1 = panel sensor
S2 = storage tank sensor

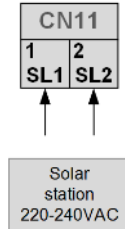

counter for components with absorption greater than 0.2A

DHW recirculation

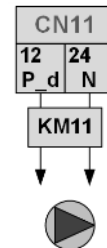
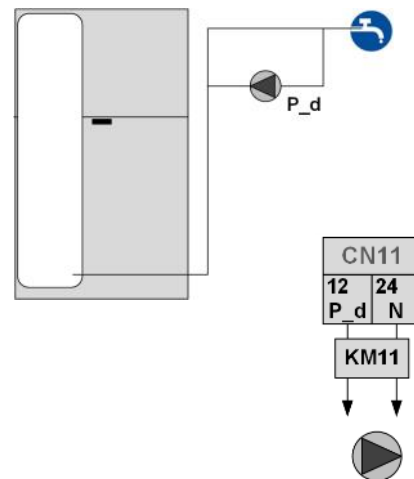

counter for components with absorption greater than 0.2A



Antifreeze e-heating tape

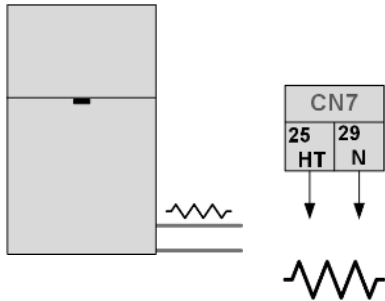

Defrost

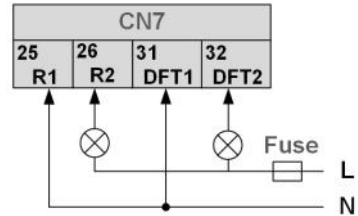

Additional electric heater

4kW: STD connection

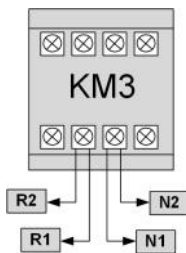

2kW: option connection

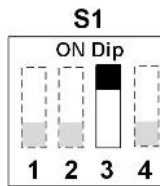
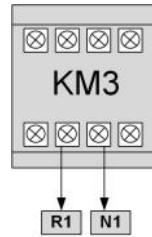

HEATING mode

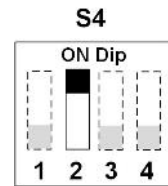

DHW mode

Additional heat source (boiler)

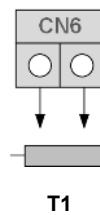
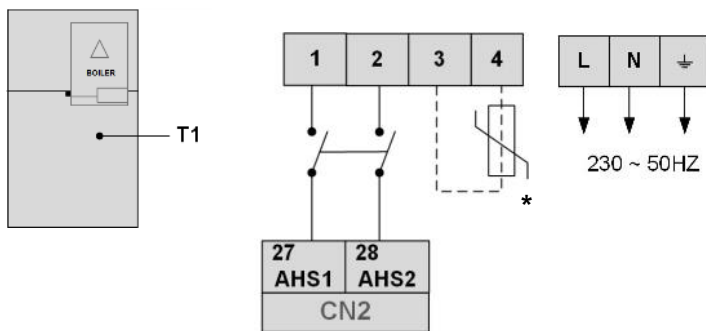

NO Boiler

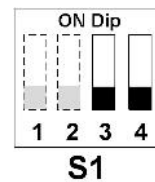

YES Boiler

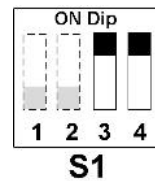

T1 = Outlet water temperature probe

* External temperature probe (supplied with the boiler)

counter for components with absorption greater than 0.2A



Component connection

Warning!

⇒ Before you insert the sensor into the sump, apply the thermally conductive paste.

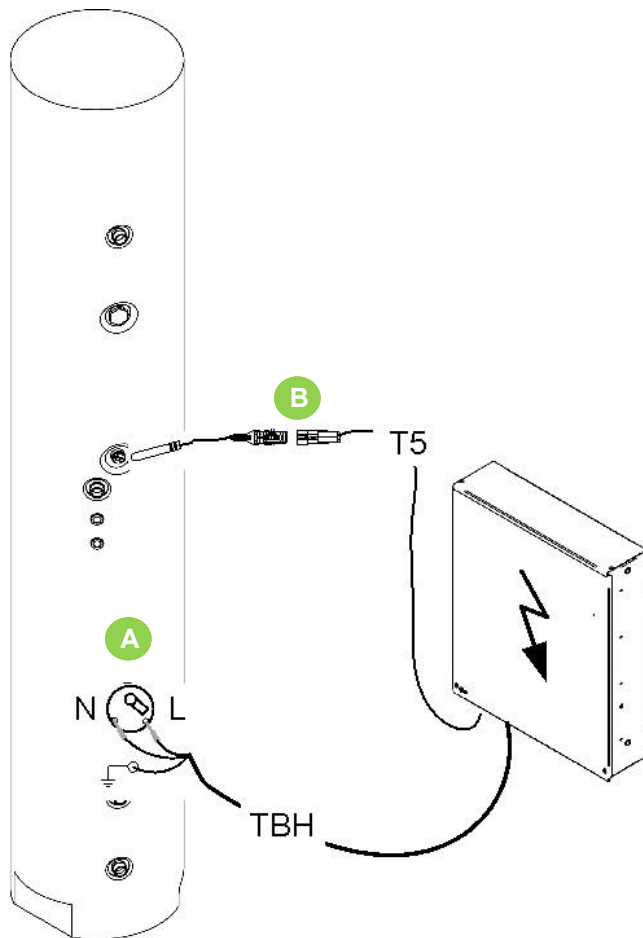

A	Domestic hot water heater (DHW)
B	Storage tank temperature probe (DHW)

220-240 ~ 50HZ



Internal unit connections

To access the panel see "Access to internal parts"
Carry out the connection in accordance with the electric connection layout.

Wiring size (mm²) = 1,5

Stated values are maximum values (see electrical data for exact values).

Note

- ⇒ The ground fault circuit interrupter must be a high-speed type breaker of 30 mA (<0.1 s).
- ⇒ Use a 3-conductor shielded cable.

3-phase supply

Only with 6 or 9kW integration electric resistance option

Bus connections

Use a 2-conductor shielded cable as an internal/external signal cable, and earth the shielding.

1-phase supply

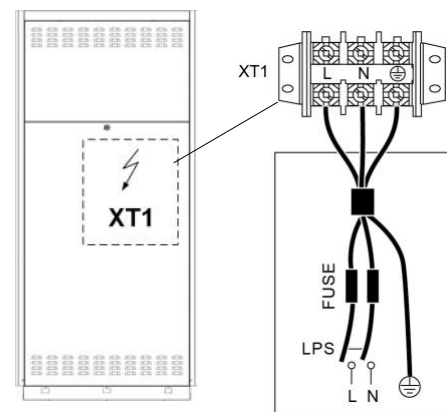

3-phase supply

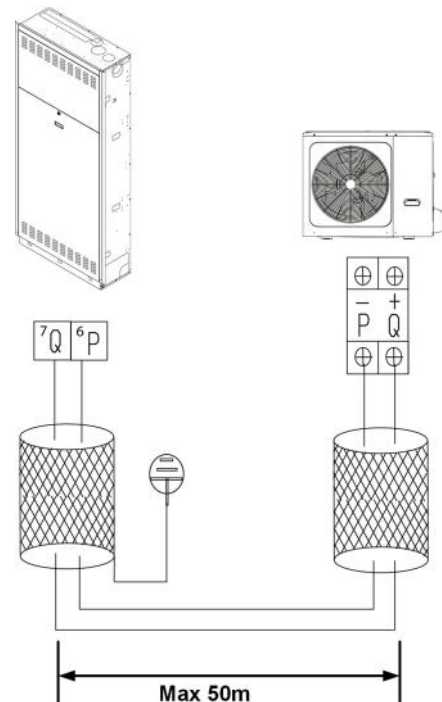
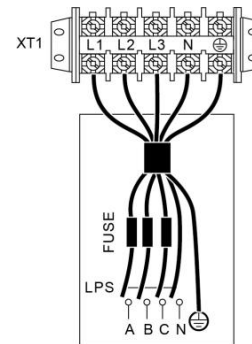

Cable type	2-core shielded wire 0,75 - 1,25 mm ² (AWG18-AWG16)
------------	---



External unit connections

Carry out the connection in accordance with the electric connection layout.

Remove the protective cover (A)

Unit (kW)	1-phase			3-phase
	2.1-3.1	4.1-5.1	6.1-8.1	6.1-8.1
Maximum overcurrent protector (MOP)	18	19	30	14
Wiring size (mm ²)	4	4	6	2,5

Stated values are maximum values (see electrical data for exact values).

Note

⇒ The ground fault circuit interrupter must be a high-speed type breaker of 30 mA (<0.1 s).

⇒ Use a 3-conductor shielded cable.

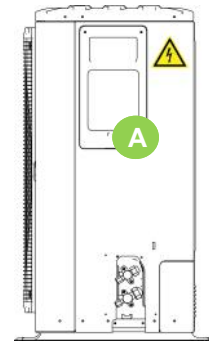

1-phase supply

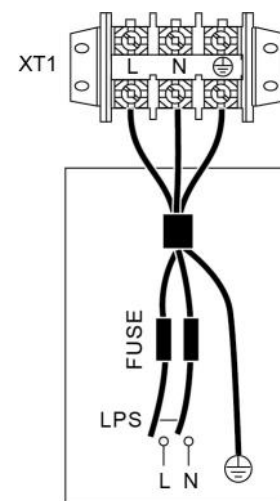

3-phase supply

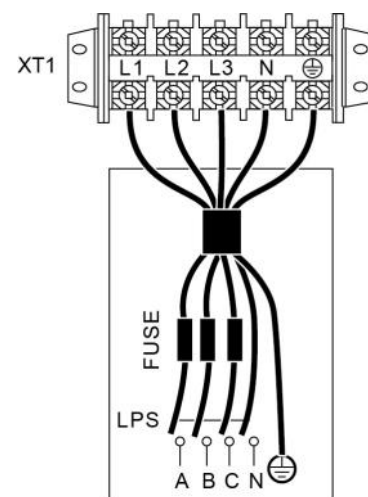



Remote unit keyboard

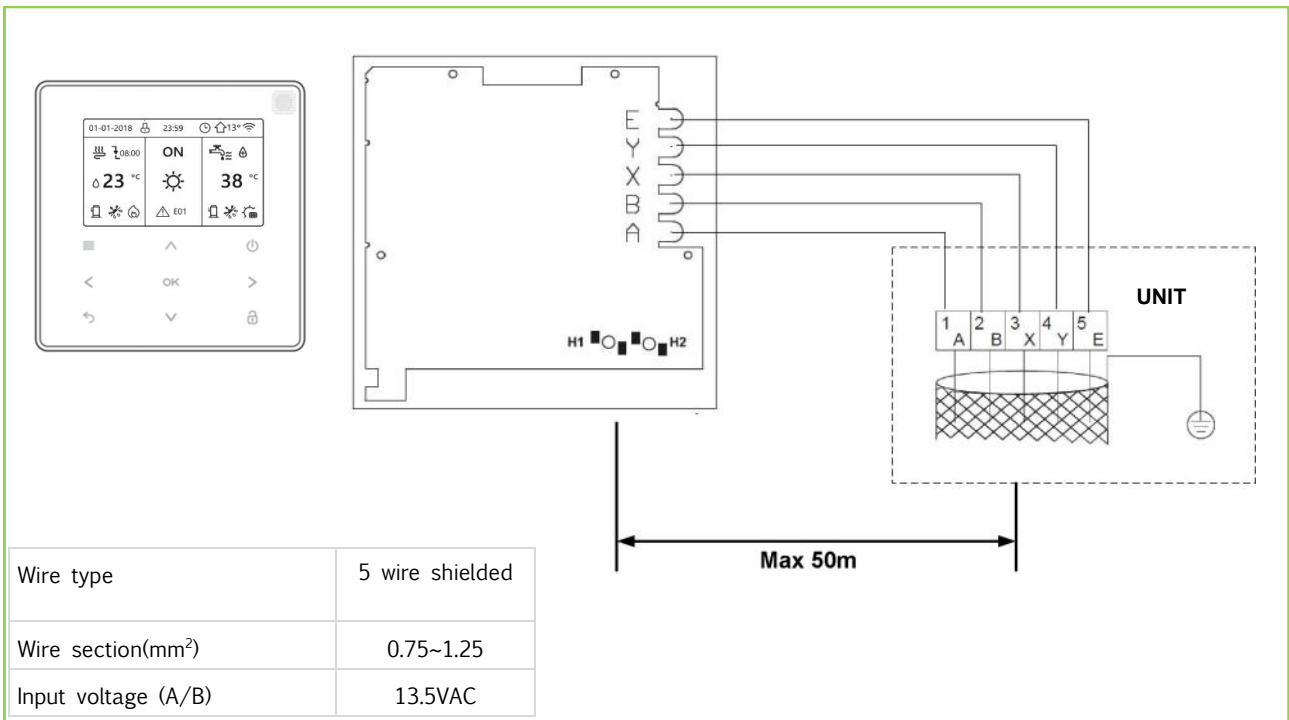

NOTE

Use shielded wire and earth the wire.

This equipment supports MODBUS RTU communication protocol.

Gestione SMART GRID - Fotovoltaico

	EVU Photovoltaic signal	SG Smart grid
Unit works normally	OFF	ON
The compressor can operate for a limited time (t_SG_Max) both in heating and cooling. IBH is not available, DHW is OFF.	OFF	OFF
Forced unit in DHW, even if it was off, with temperature increased to 70 °C	ON	ON or OFF

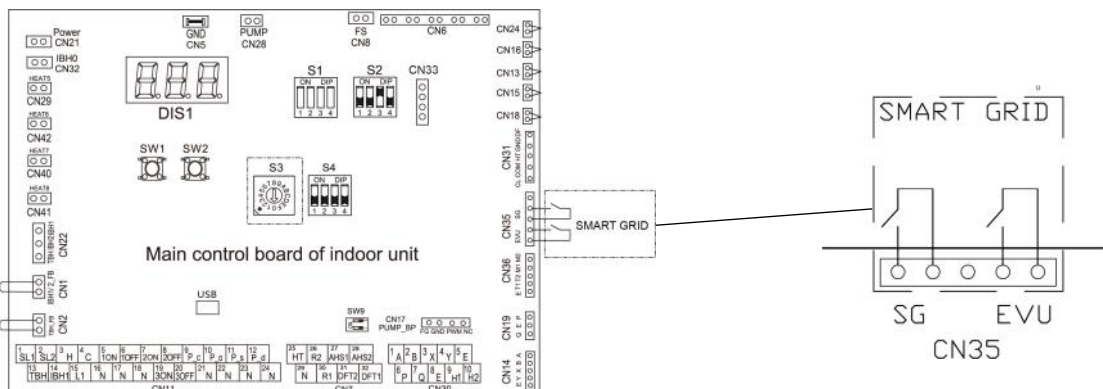



Room thermostat - Not supplied

There are three methods for connecting the thermostat cable and it depends on the application.

Method A

- On-Off + Heat from input H - L1
- On-Off + Cool from input C - L1

User interface setting:

For service man > 6. Room thermostat >
6.1 Room thermostat to Mode set

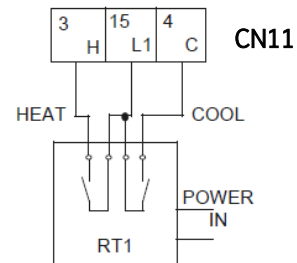

Method B

- On-Off from input H - L1
- Heat-Cool from user interface

User interface setting:

For service man > 6. Room thermostat >
6.1 Room thermostat to One zone

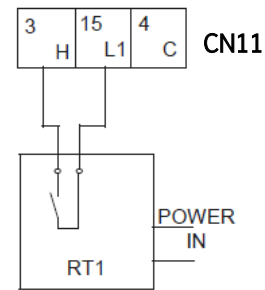

Note

⇒ When ROOM THERMOSTAT is set , the indoor temperature sensor T_a can't be set to valid, unit running only according to T_1 .

Method C

Hydraulic module is connected with two external temperature..

- On-Off zone 1 from input H - L1
- On-Off zone 1 from input C - L1
- Heat-Cool from user interface

User interface setting:

For service man > 6. Room thermostat >
6.1 Room thermostat to Double zone

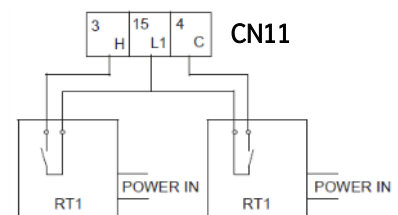

Note

⇒ The wiring of the thermostat should correspond to the settings of the user interface.

⇒ See chapter START-UP AND CONFIGURATION - ROOM THERMOSTAT.

⇒ Power supply of machine and room thermostat must be connected to the same Neutral Line and (L2) Phase Line(for 3-phase unit only).



Elfocontrol³ EVO (option)

Equipped with:

- ·12Vdc AL12X feeder
- ·Ethernet/485 converter
- ·Ethernet UTP cat.5 cable (5m long)

For details, see instructions ELFOControl³ EVO manual

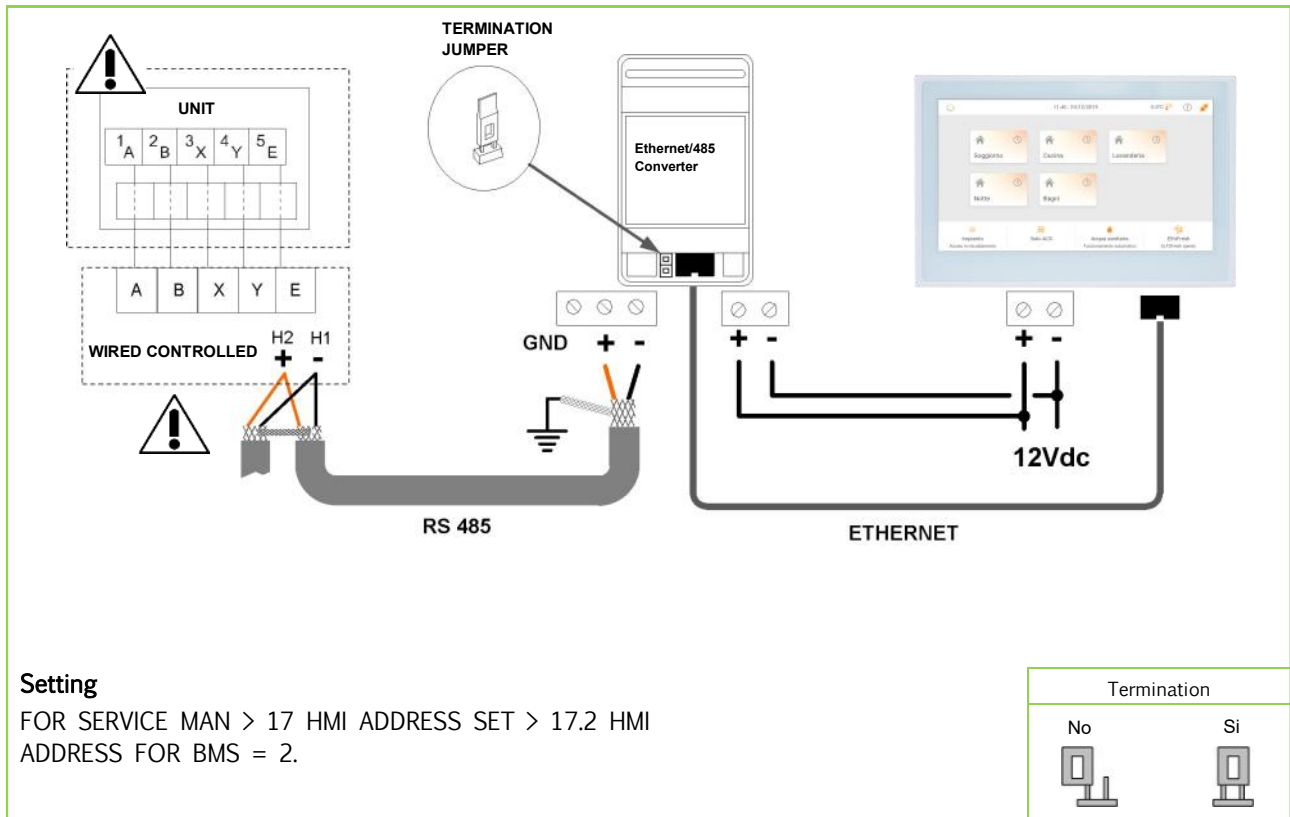

Modbus connection

Baud rate = 9600

Length = 8

Parity = none

Stop bit = 1



General

The indicated operations should be done by F.GAS qualified technician with specific training on the product. Upon request, the service centres performing the start-up.

The electrical, water connections and the other system works are by the installer.

Agree upon in advance the start-up data with the service centre.

Before checking, please verify the following:

- the unit should be installed properly and in conformity with this manual
- the electrical power supply line should be isolated at the beginning
- the unit isolator is open, locked and equipped with the suitable warning
- make sure no tension is present

WARNING

⇒ After turning off the power, wait at least 5 minutes before accessing to the electrical panel or any other electrical component.

⇒ Before accessing check with a multimeter that there are no residual stresses.

Preliminary checks

The following check list is a brief reminder of the points to check and of the operations to perform to start-up the unit.

For details on the points mentioned in the check list refer to various chapters of the manual.

	✓	Preliminary checks
1	<input type="checkbox"/>	Are the functional spaces of the internal unit and the external unit being observed ?
2	<input type="checkbox"/>	Is the section of the cooling lines correct ? Have the supplied sealing couplings <u>been</u> used ?
3	<input type="checkbox"/>	Does the equivalent length of the refrigerant piping exceed 3 or ≤ 30 m?
4	<input type="checkbox"/>	Is the height different of the refrigerant piping below 25m?
5	<input type="checkbox"/>	Have emptying and additional load been carried out ? Was there a visual check for oil / leaks ?
6	<input type="checkbox"/>	Water features are suitable? The hydraulic system has been cleaned?
7	<input type="checkbox"/>	Is the water filter from the waterworks inlet correctly installed ?
8	<input type="checkbox"/>	Is the system filter on the supply correctly installed?
9	<input type="checkbox"/>	Are the inlet and outlet of the water lines correct ?
10	<input type="checkbox"/>	Is there a non-return valve on the DHW recirculation line?
11	<input type="checkbox"/>	Present safety valve on the DHW side?
12	<input type="checkbox"/>	Present expansion vessel on the DHW side?
13	<input type="checkbox"/>	Does the system contain the minimum required amount of water?



14	<input type="checkbox"/>	Are the anti-vibration joints on the hydraulic connections present ?
15	<input type="checkbox"/>	Was the system loaded, placed under pressure and was the air let out ?
16	<input type="checkbox"/>	Have you verified the expansion tank charge ?
17	<input type="checkbox"/>	Is the solar installation present? The circuit is charged?
18	<input type="checkbox"/>	Was the condensate produced by the external unit drained correctly ? Can it freeze ?
19	<input type="checkbox"/>	Have the electrical connections to the external unit been made ?
20	<input type="checkbox"/>	Earthing connection?
21	<input type="checkbox"/>	ELFOControl ³ EVO is correctly installed? (Only if present)
22	<input type="checkbox"/>	Have optional electrical connections been made ? (summer/winter, second set, etc...)
23	<input type="checkbox"/>	Is the power supply correct ? Is the available power supply sufficient ?
24	<input type="checkbox"/>	Are the system temperature and the room temperature with the operating limits ?
25	<input type="checkbox"/>	Is the screed "dry" ? (only in presence of radiant panels)

Start-up sequence

Unit power supply ON

	✓	Start-up sequence
1	<input type="checkbox"/>	Has the carter resistance been charged for at least 8 hours ?
2	<input type="checkbox"/>	Select keyboard language
3	<input type="checkbox"/>	Set date and time
4	<input type="checkbox"/>	Sanitary water and system personalisation
5	<input type="checkbox"/>	Personalise anti-dew compensation (if radiant panels are present) only from ELFOControl ³ EVO
6	<input type="checkbox"/>	Enable solar (if present)
7	<input type="checkbox"/>	Compile documentation



Refrigerant circuit

- 1 Visually inspect the refrigerating circuit: the presence of oil stains can be a symptom of leakage (caused e.g. by transportation, handling or other).
- 2 Verify that the refrigerating circuit is in pressure: Using the unit manometers, if present, or service manometers.
- 3 Make sure that all the service outlets are closed with proper caps; if caps are not present a leak of refrigerant can be possible.
- 4 Open all of the refrigeration circuit shut-off valves (if applicable).

Hydraulic circuit

- 1 The unit is fitted with a flow switch that is used as a safety device and cannot be bypassed due to warranty purposes. Carry out the following checks when starting the unit:
 - circulator stopped > the flow switch contact must be open;
 - circulator working > the flow switch contact must close.
 If one of these two conditions does not occur, the unit displays a water flow error.
- 2 Before connecting the unit to the hydraulic system, make sure that the hydraulic system has been washed and that the water has been drained
- 3 Check that the hydraulic circuit has been filled and pressurized-
- 4 Check that the shut-off valves in the circuit are in the "OPEN" position.
- 5 Check that there is no air inside the circuit, and bleed it through the vent valves in the high points of the system if necessary.
- 6 When using antifreeze solutions, make sure the glycol percentage is suitable for the type of use envisaged.

NOTE

⇒ *Neglecting the washing will lead to several filter cleaning interventions and at worst cases can cause damages to the exchangers and the other parts.*

Weight of glycol (%)	10	20	30	40
Freezing temperature (°C)	-3.9	-8.9	-15.6	-23.4
Safety temperature	-1	-4	-10	-19

Electric circuit

Check the unit is connected to the earthing system.

Check the conductors are tightened as: the vibrations caused by handling and transport might cause these to come loose.

Power the unit by closing the isolation device but leave in OFF.

Check the network frequency and voltage values, which must be within the limits:

220/240V +/- 10%

50 Hz +/- 1%

NOTE

⇒ *Working outside of these limits can cause irreversible damages and voids the warranty.*



Compressor casing resistances

Connect the compressor oil heating resistances at least 8 hours before the compressor is to be started:

- at the first unit start-up
 - after each prolonged period of inactivity
- 1 Power the heaters: isolator switch on 1 / ON.
 - 2 Check the power consumption of the resistances to make sure that they are functioning.
 - 3 Start-up the compressor only if the crank-case temperature on the lower side is higher than the outside temperature by at least 10°C .
 - 4 Do not start the compressor with the crankcase oil below operating temperature.

Starting report

Reading the objective operating conditions is useful for checking the unit over time.

With unit of full load, namely in stable conditions and close to those of work, take the following data:

- Voltage and general absorptions with unit at full load
- Absorption of varied electrical loads (compressors, fans, pumps etc)
- Temperatures and capacities of different liquid (water, air) in the inlet and outlet of the unit.
- Temperature and pressures on the characteristic points of the refrigerating circuit (compressor discharge, liquid, intake).

The readings should be stored and made available during maintenance .

2014/68/UE PED directive

DIRECTIVE 2014/68/UE PED gives instructions for installers, users and maintenance technicians as well.

Refer to local regulations; briefly and as an example, see the following:

Compulsory verification of the first installation:

- only for units assembled on the installer's building site (for ex. Condensing circuit + direct expansion unit)

Certification of setting in service:

- for all the units

Periodical verifications:

- to be executed with the frequency indicated by the Manufacturer (see the "maintenance inspections" paragraph)



Field settings

During installation, the unit settings and parameters should be configured by the installer to suit the installation configuration, climate conditions and end-user preferences.

The relevant settings are accessible and programmable through the **FOR SERVICEMAN** menu on the unit user interface.

The user interface menus and settings can be navigated using the user interface’s touch-sensitive keys.

Note

⇒ Temperature values displayed on the wired controller (user interface) are in °C



Keys		Function
	MENU	Go to the menu structure(on the home page)
	ON / OFF	Turn on/off the space heating/cooling operation or DHW mode Turn on/or off functions in the menu structure
	UNLOCK	Long press 3 sec. for unlock /lock the controller
	OK	Enter a sub-menu Confirm entered values
 	LEFT - RIGHT DOWN - UP	Navigate in the menu structure, adjust settings
	BACK	Come back to the up level



Description of terms

The terms related to this unit are shown in the table below.

Parameter	Illustration
T1	Water outlet temperature of the backup heater or additional heating source (IBH and/or AHS)
T1B (Tw2)	Flow water temperature for low-temperature zone (only in case of 2-zone kit)
T1S	Target outlet water temperature
T2	Temperature of refrigerant at outlet /inlet of plate heat exchanger when in heat mode/cool mode
T2B	Temperature of refrigerant at let outlet /inlet of plate heat exchanger when in heat mode/cool mode
T3	Temperature of tube at outlet/inlet of condenser when in cool/heat mode
T4	Outside temperature
T5	Temperature of domestic hot water
Ta	Room temperature on the user interface (HMI)
Th	Suction temperature
Tbt1	Temperature of the inertial storage (only for cascade
T5_2 (Tbt2)	Temperature of the additional DHW storage tank
Tsolar	Water temperature of the thermal solar circuit
Tp	Discharge temperature
TW_in	Inlet water temperature of plate heat exchanger
TW_out	Outlet water temperature of plate heat exchanger
AHS	Additional heating source
IBH	Electrical resistance backup
TBH	Backup heater in the domestic hot water tank
Pe	Evaporate/condense pressure in cool/heat mode

About FOR SERVICEMAN

FOR SERVICEMAN is designed for the installer to set the parameter.

- Setting the composition of equipment.
- Setting the parameter.

How to go to FOR SERVICEMAN

Go to MENU > FOR SERVICEMAN. Press OK

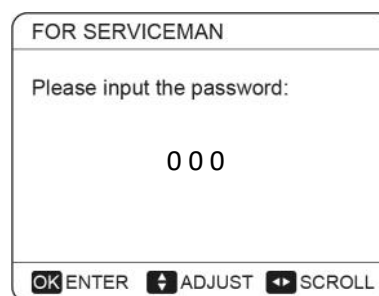

Use **LEFT** , **RIGHT** to navigate and use **Down**, **Up** to adjust the numerical value.

Press OK.

Every time the FOR SERVICEMAN menu is entered and exited, the unit restarts with the start-up countdown.

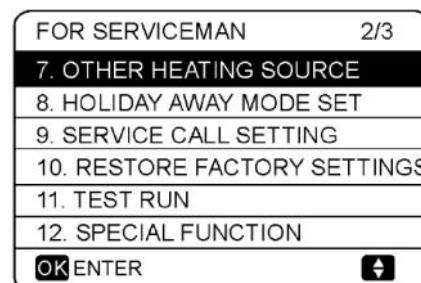
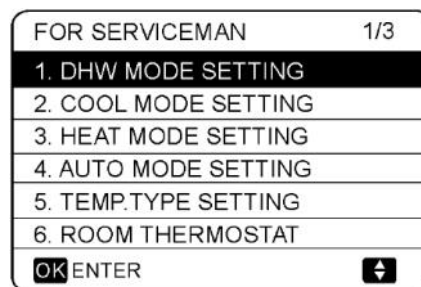



FOR SERVICEMAN	3/3
13. AUTO RESTART	
14. POWER INPUT LIMITATION	
15. INPUT DEFINE	
16. CASCADE SET	
17. HMI ADDRESS SET	
OK ENTER	↕

DHW MODE SETTING

MENU > FOR SERVICEMAN > DHW MODE SETTING

1 DHW MODE SETTING	1/5
1.1 DHW MODE	YES
1.2 DISINFECT	YES
1.3 DHW PRIORITY	YES
1.4 DHW PUMP	YES
1.5 DHW PRIORITY TIME SET	NON
↕ ADJUST	↔

1 DHW MODE SETTING	2/5
1.6 dT5_ON	5 °C
1.7 dT1S5	10°C
1.8 T4DHWMAX	43°C
1.9 T4DHWMIN	-10°C
1.10 t_INTERVAL_DHW	5 MIN
↕ ADJUST	↔

1 DHW MODE SETTING	3/5
1.11 dT5_TBH_OFF	5 °C
1.12 T4_TBH_ON	5 °C
1.13 t_TBH_DELAY	30 MIN
1.14 T5S_DI	65°C
1.15 t_DI HIGHTEMP.	15MIN
↕ ADJUST	↔

1 DHW MODE SETTING	4/5
1.16 t_DI_MAX	210 MIN
1.17 t_DHWHP_RESTRICT	30 MIN
1.18 t_DHWHP_MAX	120 MIN
1.19 DHWPUMP TIME RUN	YES
1.20 PUMP RUNNING TIME	5 MIN
↕ ADJUST	↔

1 DHW MODE SETTING	5/5
1.21 DHW PUMP DI RUN	NON
1.22 ACS FUNCTION	NO
1.23 t_ANTILOCK	60 S
↕ ADJUST	↔

DHW : domestic hot water

DHW MODE SETTING typically consists of the following:

- DHW MODE: enable or disable the DHW mode
- DISINFECT: enable or disable the disinfection (anti-legionella)
- DHW PRIORITY : set the priority between domestic hot water heating and space operation.
- DHW PUMP sets whether or not the recirculation is controlled by the unit. If the DHW pump is to be controlled by the unit select YES. If the recirculation pump is not controlled by the unit, select NON.
- DHW PUMP PRIORITY TIME SET It is a parameter that can be activated / not activated. If activated, enable parameters: 1.17 t_DHWHP_RESTRICT and 1.18 t_DHWHP_MAX.

dT5_ON sets the temperature difference between the DHW setpoint (T5S) and the storage tank temperature (T5) above which the heat pump is activated in DHW mode

When $T5S - T5 \geq dT5_ON$ the heat pump providing heated water to the DHW tank.

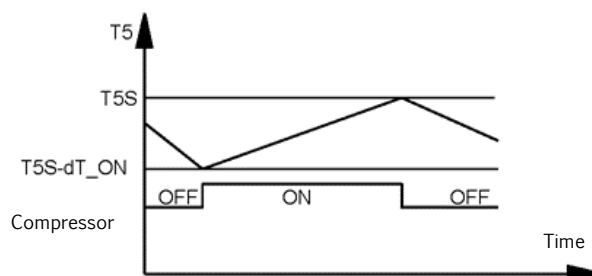

T5: DHW tank water temperature

T5S: DHW set temperature

Note: The heat pump exits the DHW mode when $T5 > T5S$, or when $T5 > T5S$ at the operating limit of the domestic hot water (T5stop). The latter varies according to the outside temperature.

dT1S5 sets the outlet temperature of the heat pump exchanger (T1S) respect to the DHW storage tank temperature (T5).

For DHW mode, the user sets the DHW set temperature (T5S) on the main screen and cannot manually set T1S.

T1S is set as $T1S = T5 + dT1S5$.

ATT. !! The default value of dT1S5 = 10

If the DHW set point (T5S) is > 50 °C, modify the value according to the following formula:

$dT1S5 = 60^\circ\text{C} - \text{setpoint ACS (T5S)}$.



Figure (under) illustrates the operation of the heat pump and immersion heater in DHW mode. If the temperature of the DHW storage tank (T5) is lower than $T5_{stop} - dT5_{ON}$, then the heat pump is activated in DHW mode.

In the event that, after the time t_{TBH_delay} has elapsed, the T5 has not yet reached $T5_{stop}$, the TBH lights up.

Once T5 reaches $T5_{stop}$ the heat pump stops and TBH continues to operate until T5 reaches $T5S + dT5_{TBH_OFF}$.

Note: When $T5S > T5_{stop}$, the operation is the same, but the heat pump bases its logics on T5S instead of on $T5_{stop}$.

DHW mode operation

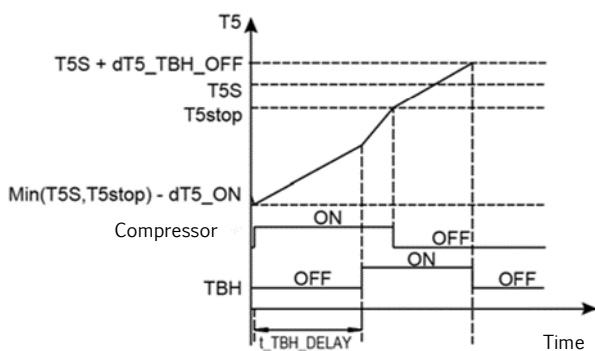

T5: DHW tank water temperature

T5S: DHW set temperature

$T5_{stop}$: Maximum temperature that can be reached in the DHW storage tank, in heat pump only.

T4DHWMAX sets the outside temperature above which the heat pump will not operate in DHW mode.

T4DHWMAX is the maximum outside temperature that the heat pump can operate at for domestic water heating. The unit will not operate if the outside temperature goes above it in DHW mode.

The highest value that **T4DHWMAX** can take is 43°C, which is the DHW mode upper outside temperature operating limit of the heat pump.

T4DHWMIN sets the outside temperature below which the heat pump will not operate in DHW mode.

T4DHWMIN is the minimum outside temperature that the heat pump can operate for domestic water heating.

The lowest value that **T4DHWMIN** can take is -25°C, which is the DHW mode lower outside temperature operating limit of the heat pump.

The heat pump will turn off if the outside temperature drops below it in water heating mode. The relationship between operation of the unit and outside temperature can be illustrated in the picture below:



HP: Heat pump

TBH: DWH tank immersion heater

T_INTERVAL_DHW is the start time interval of the compressor in DHW mode. When the compressor stops running, the next time the compressor turns on it should be **T_INTERVAL_DHW** plus one minute later at least.

dT5_TBH_OFF sets the temperature range at which the electrical resistance (TBH), if activated by the machine logic, takes the storage tank beyond the setpoint temperature ($T5S$). When $T5 > \text{Min}(T5S + dT5_{TBH_OFF}, 65^\circ\text{C})$ the electrical resistance switches off.

T4_TBH_ON is the temperature only when the outside temperature is lower than its parameter and the booster heater will be available.

t_TBH_DELAY is the time that the compressor has run before starting the booster heater (if $T5 < \text{min}(T5S, T5_{stop})$).

T5S_DI is the target temperature of water in the domestic hot water tank in the DISINFECT function.

The maximum temperature that can be set is 70°C.

t_DI_HIGHTEMP establishes the minimum duration in which $T5 > T5S_{DI}$;

t_DI_MAX defines the maximum duration of disinfection.

The change of domestic water temperature is described in the picture below:

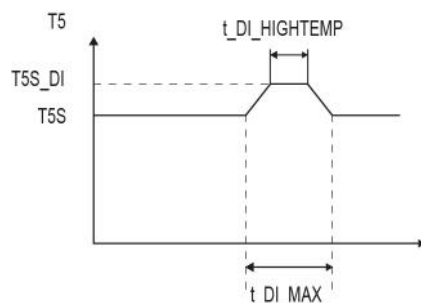

T5: DHW tank water temperature

T5S: DHW set temperature



t_DHWHP_RESTRICT RESTRICT parameter that is enabled if activated 1.5 DHW PRIORITY TIME SET. Sets the maximum length of time that the heat pump will run in space heating or space cooling modes before switching to DHW mode, if a requirement for DHW mode exists. When running in space heating mode or space cooling mode, the heat pump becomes available for DHW mode either as soon the space heating/cooling set temperatures have been reached (refer to “COOL MODE SETTING Menu” and “HEAT MODE SETTING Menu”) or after t_DHWHP_MAX minutes have elapsed.

t_DHWHP_MAX parameter that is enabled if activated 1.5 DHW PRIORITY TIME SET. sets the maximum length of time that the heat pump will run in DWH mode before switching to space heating mode or space cooling mode if a requirement for space heating/cooling modes exists. When running in DHW mode, the heat pump becomes available for space heating/cooling either as soon as the DHW tank water temperature (T5) reaches the DHW set temperature (T5S) or after t_DHWHP_MAX minutes have elapsed.

Figure illustrates the effects of t_DHWHP_MAX and t_DHWHP_RESTRICT when DHW PRIORITY is enabled. The heat pump initially runs in DWH mode. After t_DHWHP_MAX minutes, T5 has not reached

Operation in DHW PRIORITY

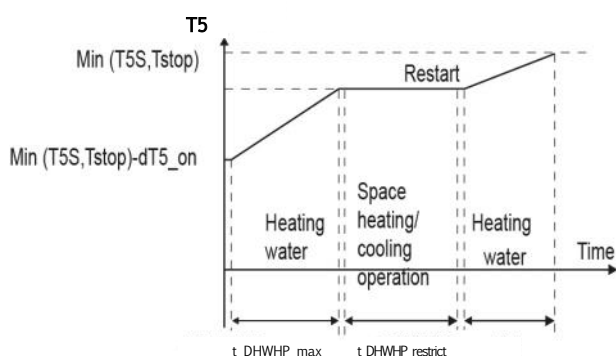

T5: DHW tank water temperature
 T5S: DHW set temperature
 T5stop: DHW mode leaving water temperature operating limit

DHW PUMP TIME RUN sets whether or not the user is able to set the recirculation pump in DHW mode. For installations with a recirculation pump, select ON so that the user is able to set pump start times.

PUMP RUNNING TIME sets the length of time the pump runs for at each of the user’s specified start times on the DHW PUMP tab on the DOMESTIC HOT WATER (DHW) menu, if TIMER RUNNING is enabled.

DHW PUMP DI RUN sets whether or not the recirculation pump (field supply) operates during the disinfection mode. To be activated with additional DHW tank.

DHW FUNCTION: Parameter enabled when 1.4 DHW PUMP is activated.

Da attivare con presenza di accumulo ACS aggiuntivo.

t_ANTILOCK: Defines the opening period of the valves for the automatic ANTILOCK function (activation of the valves if they remain in the OFF position for more than 24 hours).

After the set time has elapsed, the valve is deactivated.

Menu COOLING MODE SETTING

MENU > FOR SERVICEMAN > COOL MODE SETTING

2 COOL MODE SETTING	1/3
2.1 COOL MODE	YES
2.2 t_T4_FRESH_C	2.0HRS
2.3 T4CMAX	43°C
2.4 T4CMIN	20°C
2.5 dT1SC	5°C
ADJUST	

2 COOL MODE SETTING	2/3
2.6 dTSC	2°C
2.7 t_INTERVAL_C	5MIN
2.8 T1SetC1	10°C
2.9 T1SetC2	16°C
2.10 T4C1	35°C
ADJUST	

2 COOL MODE SETTING	3/3
2.11 T4C2	25°C
2.12 ZONE1 C-EMISSION	FCU
2.13 ZONE2 C-EMISSION	FLH
ADJUST	



In COOL MODE SETTING the following parameters should be set.

COOL MODE enables or disables cooling mode.

For installations with space cooling terminals, select YES to enable cooling mode.

For installations without space cooling terminals, select NON to disable cooling mode.

t_T4_FRESH_C sets the refresh time of cooling model climate temperature curve.

T4CMAX sets the outside temperature above which the heat pump will not operate in cooling mode. The maximum value that T4CMAX can take is 46°C, which is the cooling mode upper outside temperature operating limit of the heat pump.

T4CMIN sets the outside temperature below which the heat pump will not operate in cooling mode. The lowest value that T4CMIN can take is -5°C, which is the cooling mode lower outside temperature operating limit of the heat pump.

Refer to figure

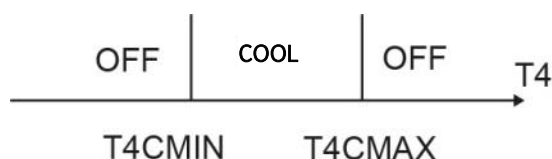

T4: outside temperature

dT1SC sets the minimum temperature difference between the heat pump leaving water temperature (T1) and the heat pump leaving water set temperature (T1S) at which the heat pump provides chilled water to the space cooling terminals.

When $T1 - T1S \geq dT1SC$ the heat pump provides chilled water to the space cooling terminals and when $T1 \leq T1S$ the heat pump does not provide chilled water to the space cooling terminals.

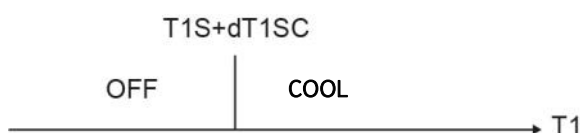

T1: Heat pump leaving water temperature

T1S: Heat pump leaving water set temperature

dTSC sets the temperature difference between the actual room temperature (Ta) and set room temperature (TS) above which the heat pump provides chilled water to the space cooling terminals.

When $Ta - TS \geq dTSC$ the heat pump provides chilled water to the space cooling terminals and when $Ta \leq TS$ the heat pump does not provide chilled water to the space cooling terminals.

Refer to figure

dTSC is only applicable if YES is selected for ROOM TEMP in the TEMP. TYPE SETTING menu. Refer to Part "TEMP. TYPE SETTING Menu"

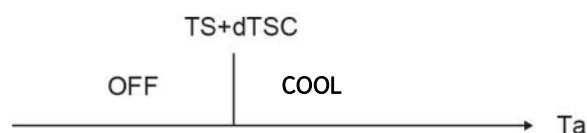

t_INTERVAL_C sets the cooling mode compressor re-start delay. When the compressor stops running, it will not re-start until at least t_INTERVAL_C minutes have elapsed.

T1SetC1 sets the temperature 1 of automatic setting curve for cooling mode.

T1SetC2 sets the temperature 2 of automatic setting curve for cooling mode.

T4C1 sets the outside temperature 1 of automatic setting curve for cooling mode.

T4C2 sets the outside temperature 2 of automatic setting curve for cooling mode.

ZONE1 C-EMISSIONI sets the emission type of zone1 for cooling mode.

Select type:

RAD = radiators (do not use)

CVC = fancoil

CRP = radiant panels

ZONE2 C-EMISSIONI sets the emission type of zone2 for cooling mode.

Select type:

RAD = radiators (do not use)

CVC = fancoil

CRP = radiant panels



Menu HEATING MODE SETTING
MENU > FOR SERVICEMAN > HEAT MODE SETTING

3 HEAT MODE SETTING	1/3
3.1 HEAT MODE	YES
3.2 t_T4_FRESH_H	2.0HRS
3.3 T4HMAX	16°C
3.4 T4HMIN	-15°C
3.5 dT1SH	5°C
ADJUST	

3 HEAT MODE SETTING	2/3
3.6 dTSH	2°C
3.7 t_INTERVAL_H	5MIN
3.8 T1SetH1	35°C
3.9 T1SetH2	28°C
3.10 T4H1	-5°C
ADJUST	

3 HEAT MODE SETTING	3/3
3.11 T4H2	7°C
3.12 ZONE1 H-EMISSION	RAD.
3.13 ZONE2 H-EMISSION	FLH
3.14 t_DELAY_PUMPI	2MIN
ADJUST	

In HEAT MODE SETTING the following parameters should be set.

HEAT MODE enables or disables heating mode.

t_T4_FRESH_H sets the refresh time of heating model climate temperature curve .

T4HMAX sets the outside temperature above which the heat pump will not operate in heating mode.

The highest value that T4HMAX can take is 35°C, which is the heating mode upper outside temperature operating limit of the heat pump. Refer to figure

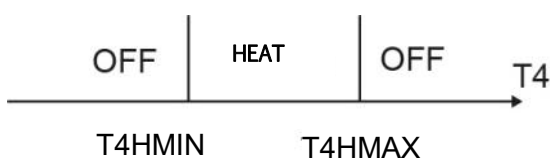

T4: outside temperature

T4HMIN sets the outside temperature below which the heat pump will not operate in heating mode. The lowest value that T4HMIN can take is -25°C, which is the heating mode lower outside temperature operating limit of the heat pump.

dT1SH sets the temperature difference between the heat pump leaving water temperature (T1) and the heat pump leaving water set temperature (T1S) above which the heat pump provides heated water to the space heating terminals

dTSH sets the temperature difference between the actual room temperature (Ta) and set room temperature (TS) above which the heat pump provides heated water to the space heating terminals.

When $TS - Ta \geq dTSH$ the heat pump provides heated water to the space heating terminals and when $Ta \geq TS$ the heat pump does not provide heated water to the space heating terminals. Refer to figure

dTSH is only relevant if YES is selected for OUTSIDE TEMP in the TEMP. TYPE SETTING menu. Refer to Part “TEMP. TYPE SETTING Menu”.



NotE:
Only when ROOM TEMP is enabled will this function be available

t_INTERVAL_H sets the heating mode compressor re-start delay. When the compressor stops running, it will not re-start until at least t_INTERVAL_H minutes have elapsed.

T1SetH1 sets the temperature 1 of automatic setting curve for heating mode.

T1SetH2 sets the temperature 2 of automatic setting curve for heating mode.

T4H1 sets the outside temperature 1 of automatic setting curve for heating mode.

T4H2 sets the outside temperature 2 of automatic setting curve for heating mode.



ZONE1 H-EMISSION sets the emission type for heating mode.

Select type:

RAD = radiators

CVC = fancoil

CRP = radiant panels

ZONE2 H-EMISSION sets the emission type for heating mode.

Select type:

RAD = radiators

CVC = fancoil

CRP = radiant panels

DELAY_PUMPI Delay in switching off the pump from OFF of the compressor.

Menu AUTO MODE SETTING

MENU > FOR SERVICEMAN > AUTO MODE SETTING

4 AUTO. MODE SETTING	
4.1 T4AUTOCMIN	25°C
4.2 T4AUTOHMAX	17°C
ADJUST	

In AUTO MODE SETTING the following parameters should be set.

T4AUTOCMIN sets the outside temperature below which the heat pump will not provide chilled water for space cooling in auto mode.

T4AUTOHMAX sets the outside temperature above which the heat pump will not provide heated water for space heating in auto mode

Refer to figure



AHS: Additional heating source

IBH: Backup electric heater

T4CMAX: The outside temperature above which the heat pump will not operate in cooling mode.

T4HMIN: The outside temperature below which the heat pump will not operate in heating mode

Menu TEMP. TYPE SETTING

MENU > FOR SERVICEMAN > TEMP. TYPE SETTING

5 TEMP. TYPE SETTING	
5.1 WATER FLOW TEMP.	YES
5.2 ROOM TEMP.	NON
5.3 DOUBLE ZONE	NON
ADJUST	

The TEMP. TYPE SETTING is used for selecting whether the water flow temperature or room temperature is used to control the ON/OFF of the heat pump.

For installations without room thermostats, space heating and cooling modes can be controlled in one way:

- the unit only manages the water temperature
- the unit manages the room temperature detected by the user interface.

WATER FLOW TEMP. if YES is selected, the user is able to set the unit leaving water temperature set temperature on the user interface's main screen.

ROOM TEMP. if YES is selected, the user is able to set the air temperature of the room where the user interface is located.

If the AMBIENT TEMP function is enabled, the setpoint for the water outlet temperature is calculated according to the climate curves.

DOUBLE ZONE select YES in case of a two-zone system.

Only WATER FLOW TEMP = YES

01-01-2018	23:59	13°
35 °C	ON	38 °C

Only ROOM TEMP = YES

01-01-2018	23:59	13°
23.5 °C	ON	38



WATER FLOW TEMP = YES

+

ROOM TEMP = YES

01-01-2018 23:59		01-01-2018 23:59	
13°		13°	
35 °C	ON	38 °C	ON
35 °C	ON	23.5 °C	ON

ZONE 1

ZONE 2

In this case the setpoint for zone 1 is T1S, the setpoint for zone 2 is TS (TIS2 is calculated in accordance with the climatic curve).

DOUBLE ZONE = YES

+

ROOM TEMP = NO

01-01-2018 23:59		01-01-2018 23:59	
13°		13°	
35 °C	ON	38 °C	ON
35 °C	ON	35 °C	ON

ZONE 1

ZONE 2

DOUBLE ZONE = YES

+

ROOM TEMP = YES

01-01-2018 23:59		01-01-2018 23:59	
13°		13°	
35 °C	ON	38 °C	ON
35 °C	ON	23.5 °C	ON

ZONE 1

ZONE 2

In questo caso il setpoint per zona 1 è T1S, il setpoint per zona 2 è T1S2 (il TIS2 corrispondente viene calcolato in accordo alla curva climatica).

Menu ROOM THERMOSTAT

MENU > FOR SERVICEMAN > ROOM THERMOSTAT

6 ROOM THERMOSTAT
6.1 ROOM THERMOSTAT NON
ADJUST

As an alternative to controlling space heating/cooling modes according to the unit leaving water temperature, it is possible to install separate room thermostats and use them to control space heating/cooling modes.

In ROOM THERMOSTAT the following parameters should be set.

ROOM THERMOSTAT sets whether or not room thermostats are installed.

For installations with room thermostats, select: ONE ZONE - DOUBLE ZONE - MODE SET.

For installations without room thermostats, select NON.

Configuration: ONE ZONE, the ON / OFF of the unit is controlled by the thermostat, while the COOLING / HEATING mode is from the keyboard on board the unit.

Configuration: TWO ZONES, the ON / OFF of the unit is controlled by the thermostat, while the COOLING / HEATING mode for both zones is controlled by the keyboard on the unit.

Configuration: SETTINGS MODE, both the ON / OFF and the COOLING / HEATING mode are controlled by the thermostat.

See chapter on electrical connections.



Menu OTHER HEATING SOURCE
MENU > FOR SERVICEMAN > OTHER HEATING SOURCE

7 OTHER HEATING SOURCE 1/2	
7.1 dT1_IBH_ON	5°C
7.2 t_IBH_DELAY	30MIN
7.3 T4_IBH_ON	-5°C
7.4 dT1_AHS_ON	5°C
7.5 t_AHS_DELAY	30MIN
ADJUST	

7 OTHER HEATING SOURCE 2/2	
7.6 T4_AHS_ON	-5°C
7.7 IBH LOCATE	PIPE LOOP
7.8 P_IBH1	0.0kW
7.9 P_IBH2	0.0kW
7.10 P_TBH	2.0kW
ADJUST	

7 OTHER HEATING SOURCE 2/2	
7.6 T4_AHS_ON	-5°C
7.7 IBH LOCATE	PIPE LOOP
7.8 P_IBH1	0.0kW
7.9 P_IBH2	0.0kW
7.10 P_TBH	2.0kW
ADJUST	

7 OTHER HEATING SOURCE 2/2	
7.6 T4_AHS_ON	-5°C
7.7 IBH LOCATE	PIPE LOOP
7.8 P_IBH1	0.0kW
7.9 P_IBH2	0.0kW
7.10 P_TBH	2.0kW
ADJUST	

In OTHER HEATING SOURCE the following parameters should be set. Backup electric heater is optional.

dT1_IBH_ON sets the temperature difference between the heat pump's leaving water set temperature (T1S) and the heat pump's leaving water temperature (T1) above which the backup electric heater heating element are on.

When $T1S - T1 \geq dT1_IBH_ON$ the backup electric heater is on (on models where the backup electric heater has a simple on/off control function).

t_IBH_DELAY sets the delay between the compressor starting and the backup electric heater being turned on.

T4_IBH_ON sets the outside temperature below which the backup electric heater is used. If the outside temperature is above T4_IBH_ON, the backup electric heater is not used.

The relationship between operation of the backup heater and the outside is shown in figure

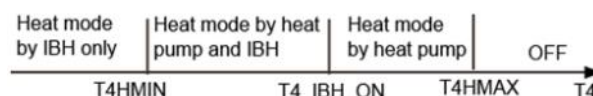

T4: outside temperature

IBH: Backup electric heater

Currently for unit the IBH is not available.

dT1_ASH_ON sets the temperature difference between the heat pump's leaving water set temperature (T1S) and the heat pump's leaving water temperature (T1) above which the additional heating source is on. When $T1S - T1 \geq dT1_ASH_ON$ the additional heating source is on.

t_ASH_DELAY sets the delay between the compressor starting and the additional heating source being turned on.

T4_AHS_ON sets the outside temperature below which the additional heating source is used. If the outside temperature is above T4_AHS_ON, the additional heating source is not used.

The relationship between operation of the additional heating source and the outside temperature is shown in the picture below.

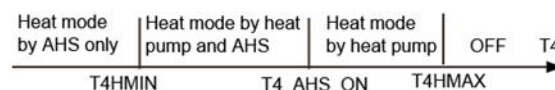

AHS: Additional heating source

T4: outside temperature

IBH POSIT.: defines the position of the IBH (only possible selection)

P_IBH1: set the electrical power of the IBH (if present).

It is used for more accurate calculation of the unit's output and efficiency.

P_IBH2: set the electrical power of IBH 2 (if present).

It is used for more accurate calculation of the unit's output and efficiency.

Not available for the SPHERA EVO 2.0 unit

P_TBH: set the electrical power of the TBH (if present).

It is used for more accurate calculation of the unit's output and efficiency.



EnSWITCHPDC: Enables or disables the € switch function.

The € switch function makes it possible to calculate the resource (between the heat pump and/or boiler) that is able to fulfil the heat demand with the lowest economic cost in every operating condition.

To use the € switch function, simply enter the cost of a cubic metre of gas (GAS_COST) and the cost of a kWh of electricity (ELE_COST), both of which can be obtained from the energy company's supply contract.

The function calculates the minimum efficiency of the heat pump required to make it more cost-effective than the boiler.

When the efficiency of the heat pump is lower than the minimum efficiency, the heat pump is switched off and the demands are handled by the boiler.

If the € switch function is activated, the boiler activation logic for integration remains unchanged.

GAS_COST: set the average cost of fuel gas used to power the boiler (in €/mc).

If you don't know this value and want to calculate it, we recommend that you take your latest gas bills, add up the various amounts (in €) and divide it by the sum of the amount of gas consumed (in mc).

ELE_COST: set the average cost of electricity (in €/kWh)

MAX_SETHEATER: maximum setpoint value that can be reached by the boiler for setpoint control by 0-10V signal.

For a Clivet boiler the value is 80°C

MIN_SETHEATER: minimum setpoint value that can be reached by the boiler for setpoint control by 0-10V signal.

For a Clivet boiler the value is 30°C

MAX_SIGHEATER: 0-10V signal relating to the maximum boiler setpoint value

For a Clivet boiler the value is 10V

MIN_SIGHEATER: 0-10V signal relating to the minimum boiler setpoint value

For a Clivet boiler the value is 3V

DELTATSOL: set the temperature difference between Tsol (if solar option is present) and T5 which activates the pump for the solar option (Pump_S).

When $T_{sol} - T_5 > \text{DELTATSOL}$ the Pump_S is activated.

Menu HOLIDAY AWAY SETTING

MENU > FOR SERVICEMAN > HOLIDAY AWAY SETTING

8 HOLIDAY AWAY SETTING	
8.1 T1S_H.A._H	20°C
8.2 T5S_H.A._DHW	20°C
⏴ ADJUST	⏵

The HOLIDAY AWAY SETTING menu settings are used to set the outlet water temperature to prevent water pipes freezing when away from home in cold weather seasons.

In HOLIDAY AWAY SETTING the following parameters should be set.

T1S_H.A._H sets the heat pump's leaving water set temperature for space heating mode when in holiday away mode.

T5S_H.M._DHW sets the heat pump's leaving water set temperature for DHW mode when in holiday away mode.

Menu SERVICE CALL

MENU > FOR SERVICEMAN > SERVICE CALL

9 SERVICE CALL SETTING	
PHONE NO.	00000000000000
MOBILE NO.	00000000000000
OK CONFIRM	⏴ ADJUST ⏵

In SERVICE CALL the following parameters can be set.

PHONE NO. and MOBILE NO. can be used to set after-sales service contact numbers.

If set, these numbers are displayed to users in MENU > FOR SERVICEMAN > SERVICE CALL

Use DOWN , UP to adjust the numerical values. The maximum length of the phone numbers is 14 digits.

The black rectangle found between 0 and 9 when scrolling up and down using DOWN, UP is converted to a blank space when the phone numbers are displayed to users in MENU > FOR SERVICEMAN > SERVICE CALL and can be used for phone numbers less than 14 digits in length.



MenU RESTORE FACTORY SETTINGS

MENU > FOR SERVICEMAN > RESTORE FACTORY SETTINGS

RESTORE FACTORY SETTINGS is used to restore all the parameters set in the user interface to their factory defaults.

On selecting YES, the process of restoring all settings to their factory defaults begins and progress is displayed as a percentage.

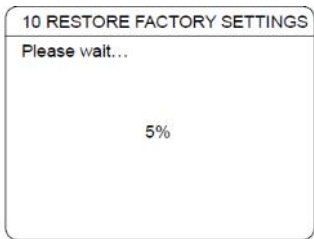
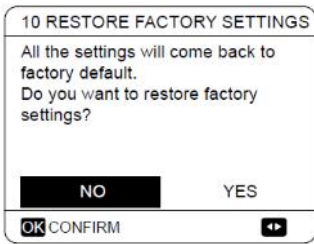

MenU TEST RUN

MENU > FOR SERVICEMAN > TEST RUN

TEST RUN is used to check that the valves, air purge function, circulation pump, space cooling mode, space heating mode and DHW mode are all operating correctly.

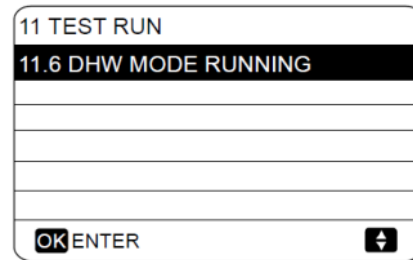

During test run, all buttons except OK are invalid. If you want to turn off the test run, please press OK. For example ,when the unit is in air purge mode, after you press OK, the following page will be displayed:

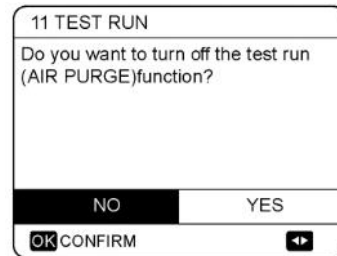

Menu POINT CHECK

MENU > FOR SERVICEMAN > TEST RUN > POINT CHECK

The POINT CHECK menu is used to check the operation of individual components. Use DOWN , UP to scroll to the components you want to check and press ON/OFF to toggle the on/off state of the component.

If a valve does not turn on/off when its on/off state is toggled or if a pump/heater does not operate when turned on, check the component's connection to the hydronic system main PCB.

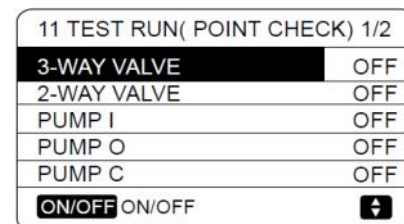
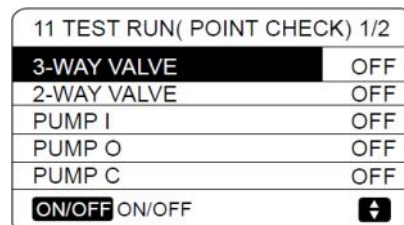
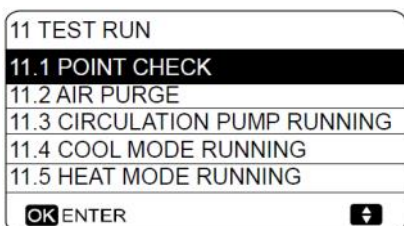
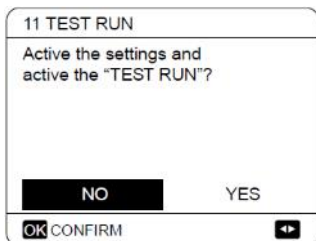



AIR PURGE operation

MENU > FOR SERVICEMAN > TEST RUN > AIR PURGE

Once installation is complete it is important to run the air purge function to remove any air which may be present in the water piping and which could cause malfunctions during operation.

The AIR PURGE operation is used to remove air from the water piping. Before running AIR PURGE mode, make sure that the air purge valve is open.

When the air purge operation starts, the 3-way valve opens and the 2-way valve closes. 60 secs later the pump in the unit (PUMPI) operates for 10min during which the flow switch does not work.

After the pump stops, the 3-way valve closes and the 2-way valve opens. 60 secs later both PUMPI and PUMPO operate until the next command is received.

If any error code is displayed during the air purge operation, the cause should be investigated.

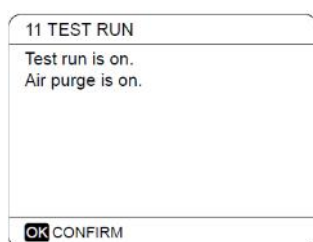

CIRCULATION PUMP RUNNING operation

MENU > FOR SERVICEMAN > TEST RUN > CIRCULATION PUMP RUNNING

The CIRCULATION PUMP RUNNING operation is used to check the operation of the circulation pump.

When the circulation pump running operation starts, all running components stop. 60 secs later, the 3-way valve opens and the 2-way valve closes.

After a further 60 secs PUMPI starts. 30 seconds later, if the flow switch detects that the water flow is normal, PUMPI operates for 3 mins after which the 3-way valve closes and the 2-way valve opens. 60s later both PUMI and PUMPO will operate.

After a further 2 mins the flow switch start to check the water flow. If the water flow rate is sufficient, both PUMPI and PUMPO operate until the next command is received. If the water flow rate is insufficient over any 15 second period, PUMPI and PUMPO stop and error code E8 is displayed.

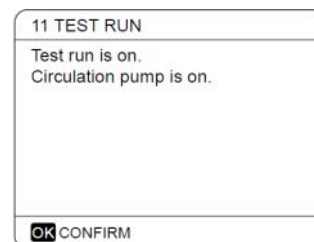

COOL MODE RUNNING operation

MENU > FOR SERVICEMAN > TEST RUN > COOL MODE RUNNING

The COOL MODE RUNNING operation is used to check the operation of the system in space cooling mode..

During the COOL MODE RUNNING operation, the unit leaving water set temperature is 7°C.

The current actual leaving water temperature is displayed on the user interface.

The unit operates until the leaving water temperature drops to the set temperature or the next command is received.

If any error code is displayed during the cool mode running operation, the cause should be investigated.

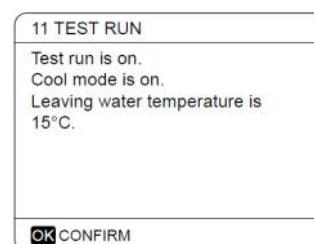



HEAT MODE RUNNING operation

MENU > FOR SERVICEMAN > TEST RUN > HEAT MODE RUNNING

The HEAT MODE RUNNING operation is used to check the operation of the system in space heating mode

During the HEAT MODE RUNNING operation the unit leaving water set temperature is 35°C. The current actual leaving water temperature is displayed on the user interface. When the HEAT MODE RUNNING operation starts, the heat pump first runs for 10 mins.

After 10 mins:

- On systems where an auxiliary heat source (AHS) is installed, the AHS starts and runs for 10 mins (whilst the heat pump continues running), after which the AHS stops and the heat pump continues to operate until the water temperature rises to the set temperature or the heat mode running operation is exited by pressing OK.
- On systems where a backup electric heater is being used, the backup heater turn on (on models where the backup heater has a simple on/off control function). 3 mins later the backup electric heater will turn off. The heat pump will then operate until the water temperature rises to the set temperature or the next command is received.
- On systems with no auxiliary heat source (AHS), the heat pump will then operate until the water temperature rises to the set temperature or the next command is received.
- If any error code is displayed during the cool mode running operation, the cause should be investigated

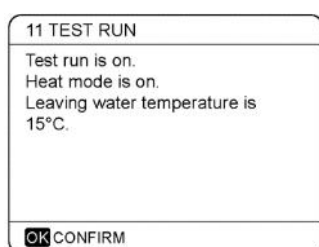

DHW MODE RUNNING operation

MENU > FOR SERVICEMAN > TEST RUN > DHW MODE RUNNING

The DHW MODE RUNNING operation is used to check the operation of the system in DHW mode. During the DHW MODE RUNNING operation, the DHW set temperature is 55°C.

The tank boost heater will turn on once the heat pump has run for 10 mins.

The tank boost heater will turn off 3 mins later and the heat pump will operate until the water temperature rises to the set temperature or the next command is received.

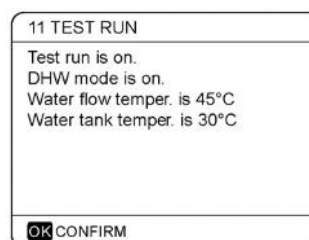

SPECIAL FUNCTION

MENU > FOR SERVICEMAN > SPECIAL FUNCTION

SPECIAL FUNCTION is used to pre-heating floor and drying up floor once installation is complete or the first time start up the unit or restart the unit after a long time stop.

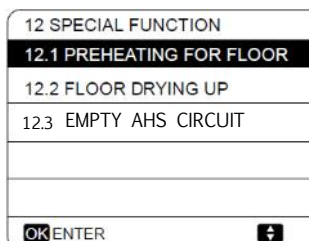
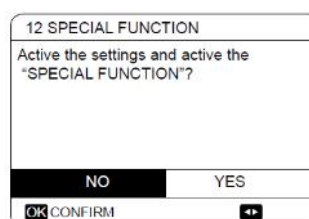



PREHEATING FOR FLOOR
MENU > FOR SERVICEMAN > SPECIAL FUNCTION >
PREHEATING FOR FLOOR

12.1 PREHEATING FOR FLOOR	
T1S	30°C
t_fristFH	72 HOURS
ENTER	EXIT
ADJUST	ADJUST

Before floor heating, if a large amount of water remains on the floor, the floor may be warped or even rupture during floor heating operation, in order to protect the floor, floor drying is necessary, during which the temperature of the floor should be increased gradually.

During first operation of the unit, air may remain in the water system which can cause malfunctions during operation. It is necessary to run the air purge function to release the air (make sure the air purge valve is open).

T1S is the target outlet water temperature in preheating for floor mode.

t_fristFH is the time last for preheating floor.

The operation of the unit during preheating for floor described in the picture below:

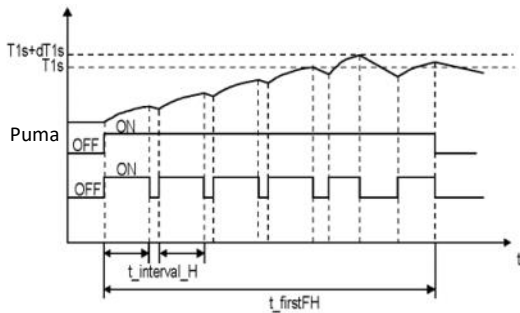

t_interval_H: Compressor restart delay in space heating mode.

Whilst the preheating for floor operation is running, the number of minutes that it has been running for and the heat pump's leaving water temperature are displayed on the user interface. During the preheating for floor operation all buttons except OK are inactivated.

To exit the preheating for floor operation, press OK and then select YES when prompted.

Refer to figure

12.1 PREHEATING FOR FLOOR	
Preheat for floor is running for 25 minutes. Water flow temperature is 20°C.	
OK CONFIRM	

12.1 PREHEATING FOR FLOOR	
Do you want to turn off the preheating for floor function?	
NO	YES
OK CONFIRM	ADJUST

FLOOR DRYING UP
MENU > FOR SERVICEMAN > SPECIAL FUNCTION >
FLOOR DRYING UP

12.2 FLOOR DRYING UP	
t_DRYUP	8 days
t_HIGHPEAK	5 days
t_DRYDOWN	5 days
T_DRYPEAK	45°C
START TIME	15:00
ADJUST	

12.2 FLOOR DRYING UP	
START DAY	01-01-2019
ENTER	EXIT
ADJUST	ADJUST



For newly-installed under-floor heating systems, floor drying up mode can be used to remove moisture from the floor slab and subfloor to prevent warping or rupture of the floor during floor heating operation.

There are three phases to the floor drying up operation:

- Phase 1: gradual temperature increase from a starting point of 25°C to the peak temperature
- Phase 2: maintain peak temperature
- Phase 3: gradual temperature decrease from the peak temperature to 45°C

t_{DRYUP} is the day for warming up.

t_{HIGHPEAK} is the continue days in high temperature.

t_{DRYDOWN} is the day of dropping temperature

T_{DRYPEAK} is the target peak temperature of water flow during floor drying up.

START TIME sets the floor drying up operation start time

START DATE sets the floor drying up operation start date.

The target outlet water temperature during floor drying up described in the picture below:

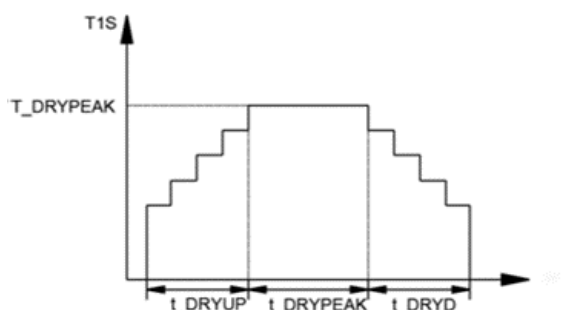

During the floor drying up operation all buttons except OK are inactivated.

To exit the floor drying up operation, press OK and then select YES when prompted.

Note: In the event of a heat pump malfunction, floor drying up mode will continue if a backup electric heater and/or additional heating source is available and configured to support space heating mode.

12.2 FLOOR DRYING UP	
START DAY	01-01-2019
ENTER	EXIT
ADJUST	

EMPTY CIRCUIT

MENU > FOR SERVICEMAN > SPECIAL FUNCTION > EMPTY AHS CIRCUIT

12 SPECIAL FUNCTION	
12.1 PREHEATING FOR FLOOR	
12.2 FLOOR DRYING UP	
12.3 EMPTY AHS CIRCUIT	
OK ENTER	

12.3 EMPTY AHS CIRCUIT	
AHS circuit is open for 0 minutes.	
OK CONFIRM	

12.3 EMPTY AHS CIRCUIT	
Do you want to turn off the empty AHS circuit function?	
NO	YES
OK CONFIRM	

ATT. Before carrying out the function, switch off the boiler

EMPTY AHS CIRCUIT allows, in case of an auxiliary heating source connected to the unit, to empty the system by activating the additional valve and freeing any water stagnation.

AUTO RESTART

MENU > FOR SERVICEMAN > AUTO RESTART

The AUTO RESTART function is used to select whether the unit reapplies the user interface settings at the time when power returns after a power supply failure.

Select YES to enable auto restart or NON to disable auto restart.



If the auto restart function is enabled, when the power returns following a power failure, the unit re-applies the user interface settings from before the power failure.

If the auto restart function is disabled, when the power returns after a power failure, the unit won't auto restart.

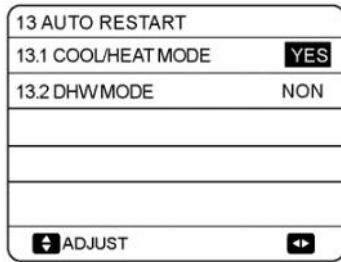

POWER INPUT LIMITATION

MENU > FOR SERVICEMAN > POWER INPUT LIMITATION

How to set the POWER INPUT LIMITATION

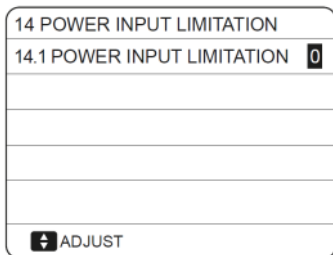

Sets the type of power input limitation and the setting range is 0-8.

If the unit will operate at larger power input, 0 should be selected.

If the unit will operate at a lower power input, 1-8 should be selected and the power input and capacity will decrease.

Size.	No.	0	1	2	3	4	5	6	7	8
2.1-3.1		18	18	16	15	14	13	12	12	12
4.1-5.1		19	19	18	16	14	12	12	12	12

INPUT DEFINE

MENU > FOR SERVICEMAN > INPUT DEFINE

How to set the INPUT DEFINE

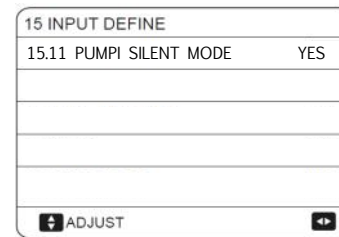
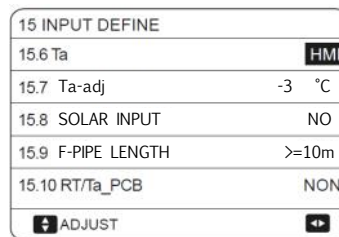
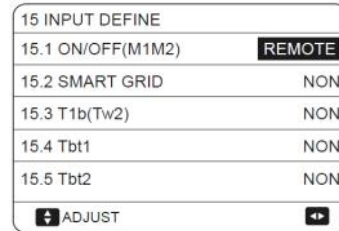

15.1 --> Enable contacts CN12 as REMOTE ON / OFF or as TBH ON / OFF;

15.2 --> Enable a SMART GRID;

15.3 --> Enable option 2 HIGH / LOW temperature ZONES;

15.4 --> Enable the inertial storage temperature probe (only for cascade unit function)

15.5 --> Enable additional DHW storage tank temperature probe

15.6 --> Sets the position of the room temperature probe (to use the user interface as a thermostat, set to "HMI")

15.7 --> Sets the offset of the room temperature read by the user interface.

15.8 --> Enable the solar option. ONLY SOLAR (the DHW is heated by the solar option only). SOLAR + HP (DHW is produced by both solar and heat pump);

15.9 --> The length of the piping between the indoor unit and the outdoor unit

15.10 --> Enables external temperature control (not available for this version)

15.11 --> Limits the internal pump of the unit (not available for this version)



CLIMATE CURVES

The climate related curves can be selected in the user interface, MENU > PRESET TEMPERATURE > WEATHER TEMP. SET.

The curves for heating mode and ECO heating mode are the same but the default curve is curve 4 in heating mode, while in ECO mode, the default curve is curve 6.

The default curves for cooling mode is curve 4. Once the curve is selected, the leaving water set temperature (T1s) is determined by the outdoor temperature.

In each mode, each curve from the eight curves in the user interface can be selected.

The relationship between outside temperature (T4) and leaving water set temperature (T1s) is described as in Figure A, Figure B, Figure C and Figure D

The automatic setting curves are the ninth curve for cooling and heating mode, the ninth curve can be set as in Figure E and Figure F

PRESET TEMPERATURE		
PRESET TEMP.	WEATHER TEMP.SET	ECO MODE
ZONE1 C-MODE LOW TEMP.		OFF
ZONE1 H-MODE LOW TEMP.		OFF
ZONE2 C-MODE LOW TEMP.		OFF
ZONE2 H-MODE LOW TEMP.		OFF
ON/OFF	ON/OFF	

Figure A

Low temperature curves for heating mode1

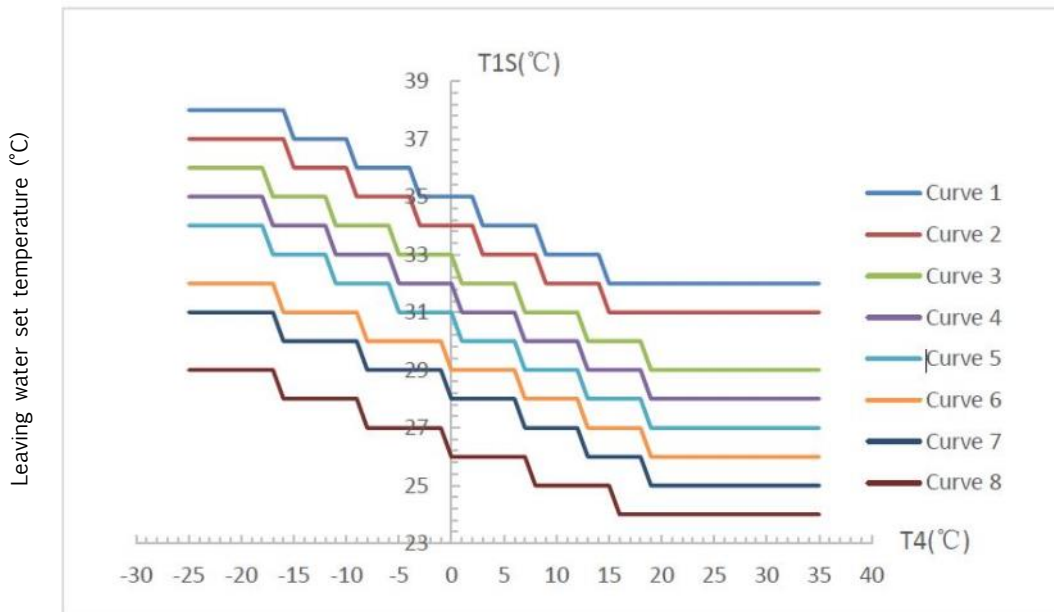

Notes:

- 1 Selectable when the low temperature for heating is set.
- 2 Curve 4 is default in low temperature heating mode and curve 6 is default in ECO mode.



Figure B

High temperature curves for heating mode

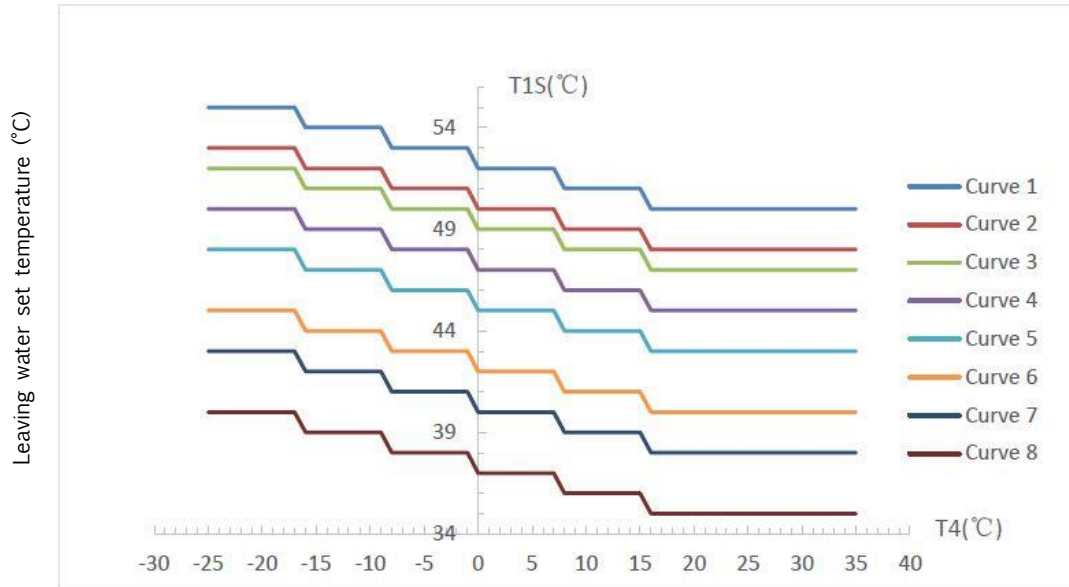

Note:

- 1 Selectable when the high temperature for heating is set.
- 2 Curve 4 is default in high temperature heating mode and curve 6 is default in ECO mode.

Figure C

Low temperature curves for cooling mode

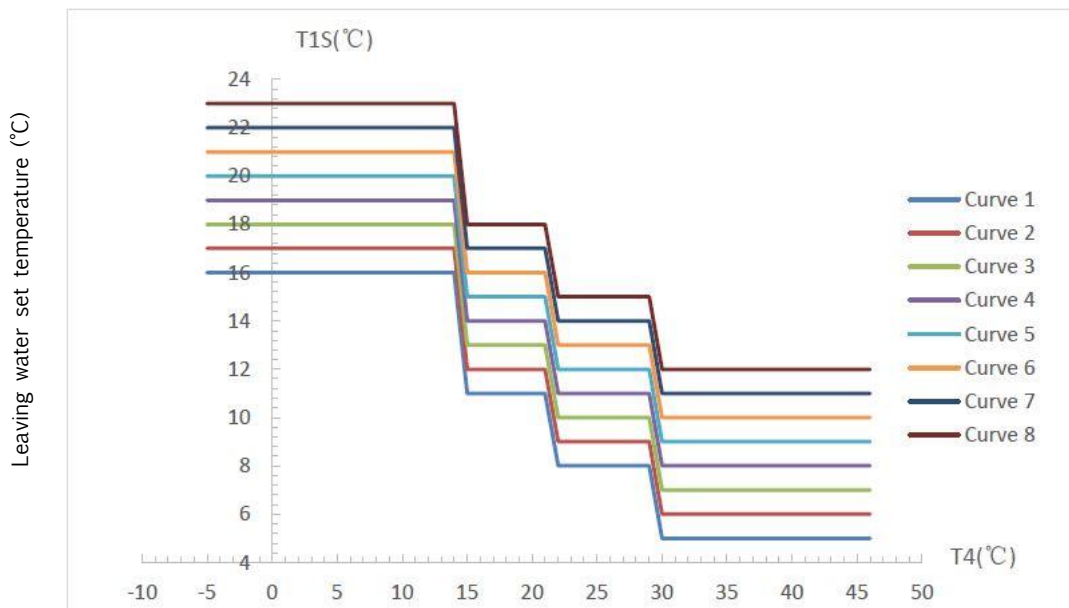

Notes:

- 1 Selectable when the low temperature for cooling is set.
- 2 Curve 4 is default in low temperature cooling mode.



Figure D

High temperature curves for cooling mode

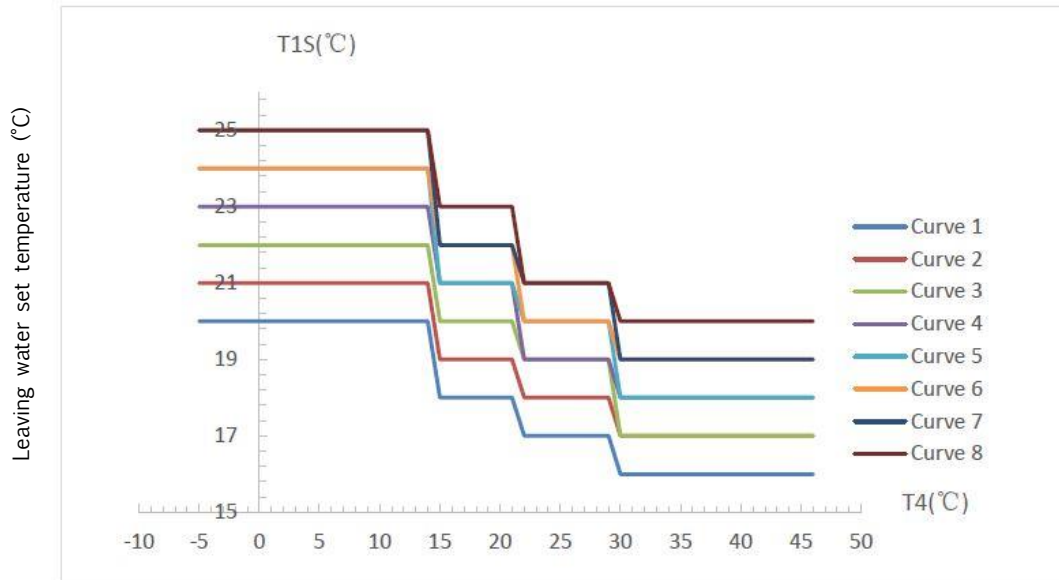

Notes:

- 1 Selectable when the high temperature for cooling is set.
- 2 Curve 4 is default in high temperature cooling mode.

Automatic setting curve for heating mode

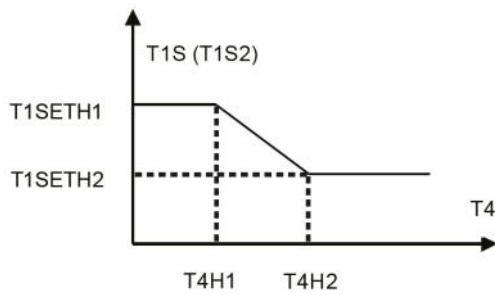

Automatic setting curve for cooling mode

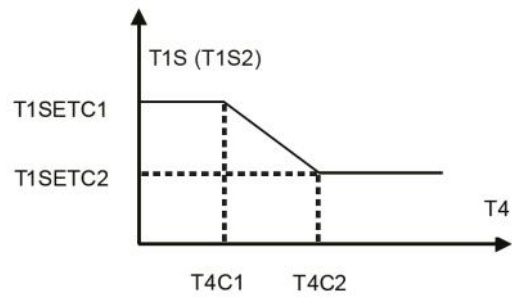

The setting of T1SETH1, T1SETH2, T4H1, T4H2 refer to Part "HEATING MODE SETTING Menu" and T1SETC1, T1SETC2, T4C1, T4C2 refer to Part "COOLING MODE SETTING Menu".



Key		Functionn
	MENU	Enter the menu structure from the home page
	ON / OFF	To set the ON / OFF function or DHW mode turn on or off the function in the menu structure
	UNLOCK	Long press for unlocking /locking the controller
	OK	Go to the next step when programming a schedule in the menu structure / confirm a selection/enter a submenu in the menu structure
	LEFT - RIGHT	Navigate the cursor on the display/navigate in the menu structure/adjust the settings
	DOWN - Up	
	BACK	To return to the previous level. Press to exit the current page and return to the previous page. Long press to return straight to the home screen.

Auto-restart function

The unit is equipped with an auto-restart function: in the event of a power failure (eg. black-out), when this is restored the unit restarts at the last settings selected.

10 CONTROL

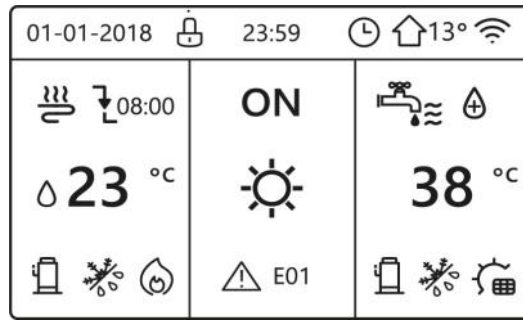

	Lock		The compressor is activated
	At the next scheduled action, the temperature will decrease.		The pump is activated
	The temperature not change		Weekly schedule
	The temperature will decrease		Timer
	The temperature will increase		Outside temperature
	Fan coil		Wi-Fi
	Radiator		Domestic hot water
	The floor heating (panels radiants)		The disinfect (anti-legionella) function is activated
	System water supply temperature (configurable)	ON OFF	ON OFF
	Heat mode		DHW tank temperature
	Cool mode		The solar energy is activated
	Auto mode		Active electrical storage tank resistance
	Additional heat source		Allarm
	Electrical resistance		Smart grid mode

Prevent freezing is activated 	Defrost mode is activated 	Holiday away/home is activated 	Silent mode is activated 	Eco mode is activated
-----------------------------------	-------------------------------	------------------------------------	------------------------------	---------------------------



	Fan coil	Radiator	The floor heating	Domestic hot water
ON				
OFF				

Energy cost	Free	Low	High
Smart grid			
Energy source	Photovoltaics	From the network	From the network
Energy absorbed	Everage	Everage	Peak

The main screen changes according to the type of system



The installer is responsible for configuration.

1) 1 single zone system

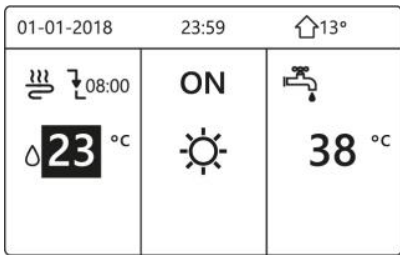

Keyboard control:

MENU > FOR SERVICEMAN > ROOM THERMOSTAT > ROOM THERMOSTAT = NON

Thermostat control:

MENU > FOR SERVICEMAN > ROOM THERMOSTAT > ROOM THERMOSTAT = ONE ZONE

2) double zone system

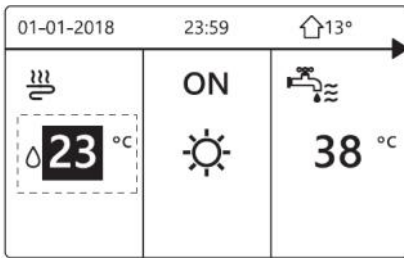

Keyboard control:

MENU > FOR SERVICEMAN > ROOM THERMOSTAT > ROOM THERMOSTAT = NON

Press BACK

Selection TEMP. TYPE SETTING > DOUBLE ZONE= YES

Thermostat control:

MENU > FOR SERVICEMAN > ROOM THERMOSTAT > ROOM THERMOSTAT = DOUBLE ZONE

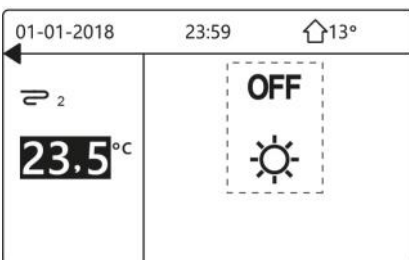



Menu structure

Press 3 sec. "UNLOCK" to unlock the keyboard.

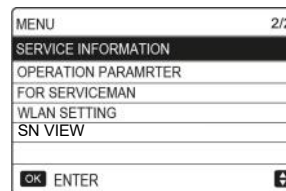
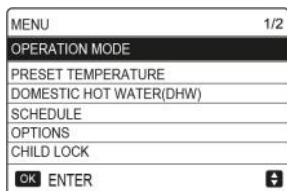

Operation mode

Heat
Cool
Auto

Preset temperature

Preset temperature
Weather temperature set
ECO mode

Domestic hot water (DHW)

Disinfect (anti-legionella)
Fast DHW
Tank heater
DHW pump (recirculation)

Schedule

Timer
Weekly schedule
Schedule check
Cancel timer

Options

Silent mode
Holiday away
Holiday home
Backup heater

Child lock

Please input the password
Cool/heat temp. adjust
Cool/heat mode on/off
DHW temp. adjust
DHW mode on/off

Service information

Service call
Error code
Parameter
Diplay

Operation parameter

Consultation only

For serviceman *

Please input the password
DHW mode setting
Cool mode setting
Heat mode setting
Auto mode setting
Temp. type setting
Room thermostat
Other heating source
Holiday away setting
Service call
Restore factory settings
Test run
Special function
Auto restart
Power input limitation
Input define
Cascade set
HMI address set
* The access by pwd is reserved to qualified personnel; The parameters changes may cause malfunctions

Wlan setting

Ap mode
Restore wlan setting

Sn view



Using home pages

When you turn on the wired controller, the system will enter the language selection page, You can choose your preferred language, then press OK to enter the home pages.

If you don't press OK in 60 seconds, the system will enter in the currently selected language.



You can use the home pages to read out and change settings that are meant for daily usage. What you can see and do on

the home pages is described where applicable. Depending on the system layout, the following home pages may be possible:

- Room desired temperature (ROOM)
- Water flow desired temperature (MAIN)
- Double zone system water supply temperature

Menu structure

About the menu structure

You can use the menu structure to read out and configure settings that are NOT meant for daily usage.

What you can see and do in the menu structure is described where applicable.

To go to the menu structure

From a home page, press MENU.

Result: The menu structure appear

To navigate in the menu structure

Press **Down**, **Up** to scroll

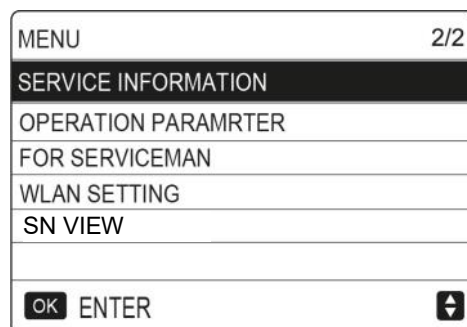
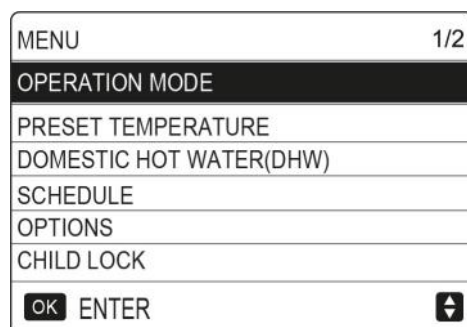



Screen Unlock

If the icon UNLOCK is on the screen, the controller is locked.

The following page is displayed:

Press any key, the icon UNLOCK will flash.

Long press the "UNLOCK" key.

The icon will disappear, the interface can be controlled.

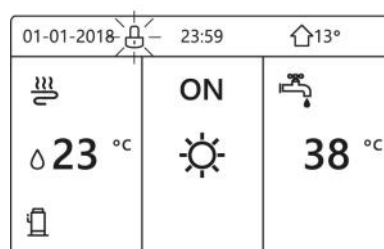
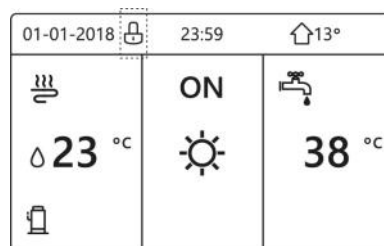

The interface will be locked if there is no handling for a long time (about 120 seconds: it can be set by the interface, see SERVICE INFORMATION).

If the interface is unlocked, long press "UNLOCK", the interface will be locked.

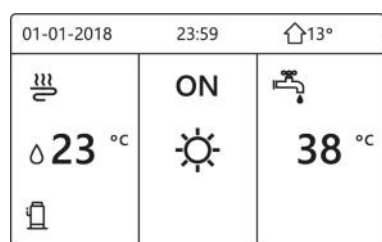

Long press UNLOCK

UNLOCK ↓ ↑ UNLOCK

Long press UNLOCK

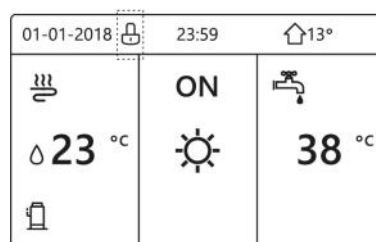



Unit OFF/ON

For switching the unit on/off, the black selection cursor must not be present.

Press the ON/OFF button for 5 seconds.

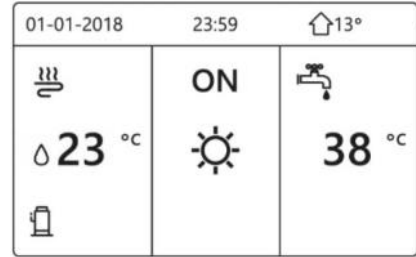

Turning ON/OFF controls

Use the interface to turn on or off the unit for space heating or cooling.

- The ON/OFF of the unit can be controlled by the interface if the ROOM THERMOSTAT is NON. (see FOR SERVICEMAN).
- Press **LEFT** or **Up** on home page, the black cursor will appear

- 1 When the cursor is on the temperature of space operation mode side (Including heat mode, cool mode and auto mode), press "ON/OFF" key to turn on/off space heating or cooling.
- 2 Press **RIGHT**, the cursor is on the DHW side, press the "ON/OFF" button to turn the DHW on/off.

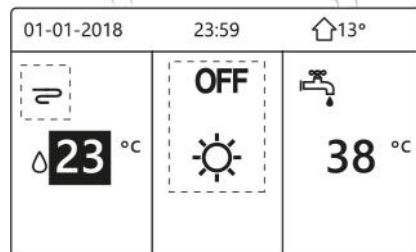
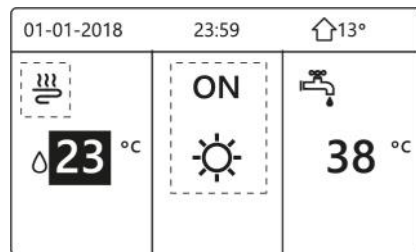
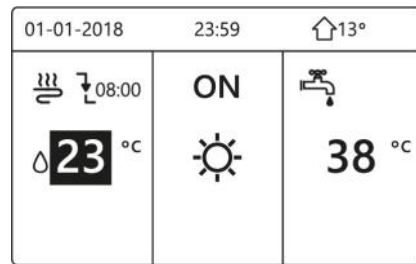



If DHW MODE SETTING is set on NO, the following screens will be displayed without the DHW function.

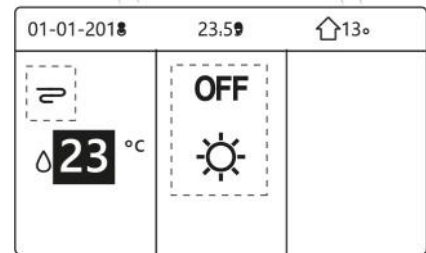
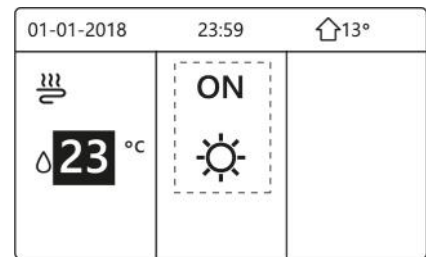

Use the room thermostat to turn on or off the unit for space heating or cooling.

- If the ROOM THERMOSTAT is set on:
 - DOUBLE ZONE, ONE ZONE = the unit can be turned on or off with the room thermostat. The following screen appears if ON/OFF is pressed on the interface.
 - MODE SETTING = can be turned on or off with the room thermostat and controls the heating and cooling mode. (see the FOR SERVICEMAN section).

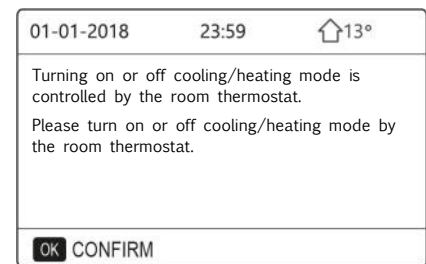

- The room thermostat is set NON (see FOR SERVICEMAN). Press **LEFT or Up** on the screen, the black cursor will appear. When the cursor is on the system temperature side, press the ON/OFF button to turn the fancoil on/off.

The following page is displayed:

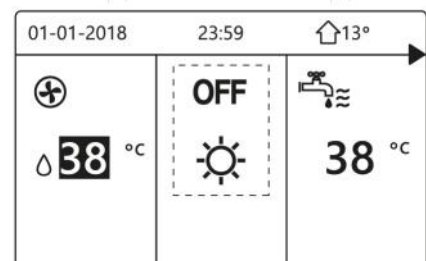
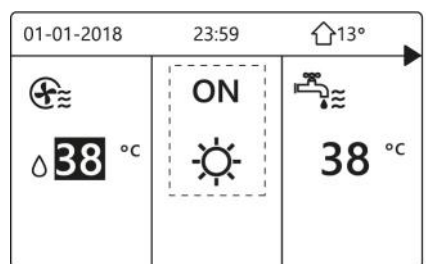



Press **RIGHT** on the screen and the black cursor appears.
When the cursor is on the system temperature side, press the ON/OFF button to turn the radiant panels on/off.

The following page is displayed

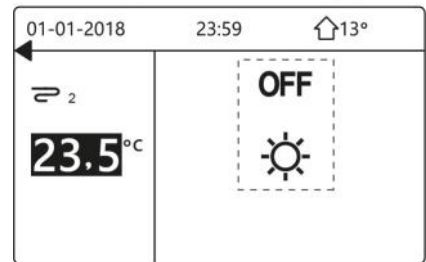
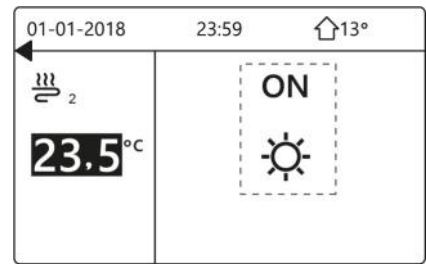

Use the interface to turn on or off the unit for DHW.

Press **RIGHT** on home page, the black cursor will appear
When the cursor is on the DHW temperature side, press the ON/OFF button to turn the domestic hot water production on/off.

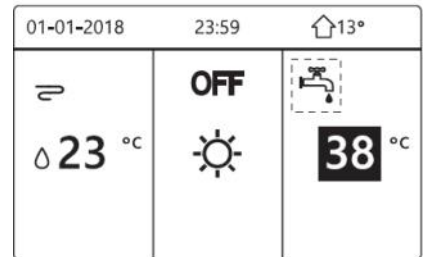
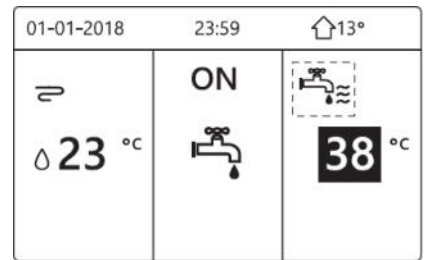
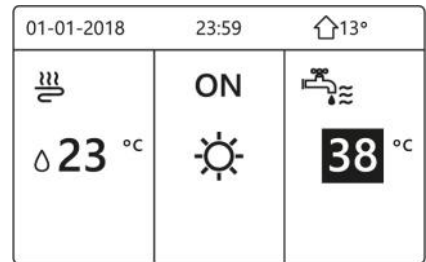



Adjusting the temperature

System water / DHW

Press **LEFT** or **Up** on home page, the black cursor will appear

If the cursor is on the temperature, use the **LEFT** , **RIGHT** to select and use **Up**, **Down** to adjust the temperature.

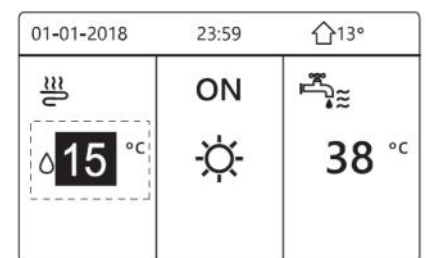
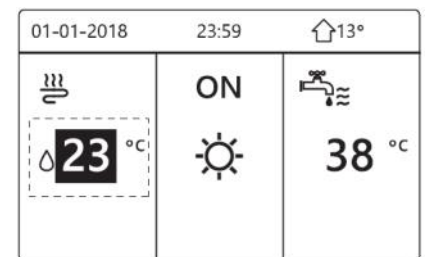
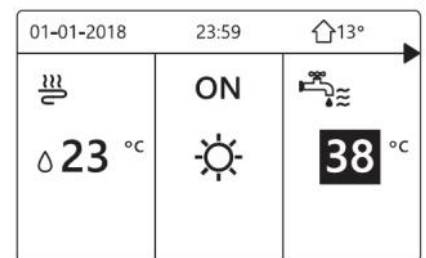
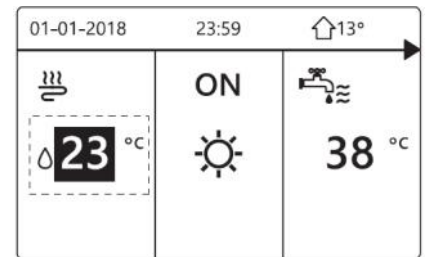
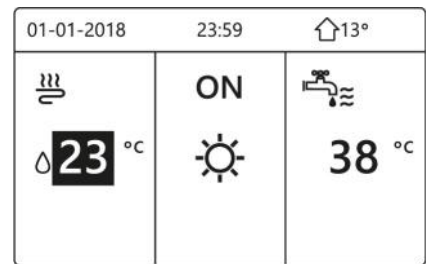



Adjusting space operation mode

Adjusting space operation mode by interface

Go to MENU > OPERATION MODE .

Press OK

The following page will appear:

There are three modes to be selected including HEAT, COOL and AUTO mode.



Use the **LEFT** or **RIGHT** to scroll, press "OK" to select.

Even you don't press OK button and exit the page by pressing BACK button, the mode would still be effective if the cursor had been moved to the operation mode.

If there is only HEAT(COOL) mode, the following page will appear

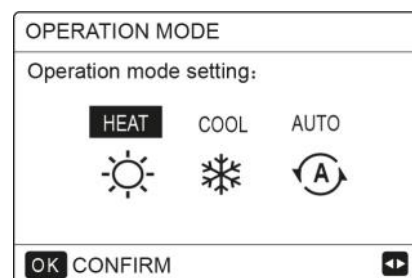
The operation mode can not be changed.



If you select...	Then the space operation mode is...
 heat	Heating mode
 cool	Cooling mode
 Auto	Automatically changed by the software based on the outdoor temperature (and depending on installer settings of the indoor temperature), and takes monthly restrictions into account. Note: Automatic changeover is only possible under certain conditions. See the FOR SERVICEMAN > AUTO MODE SETTING

Adjust space operation mode by the room thermostat, see FOR SERVICEMAN > ROOM THERMOSTAT.

Go to MENU > OPERATION MODE.

Press any selection or control button and the following screen will be displayed, if room thermostat = MODE SETTING is selected

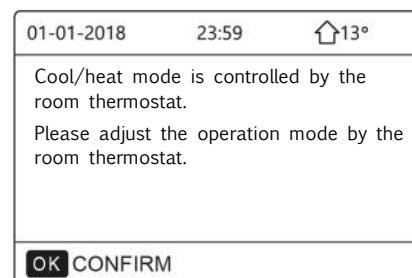



Preset Temperature

PRESET TEMPERATUER has PRESET TEMP.\WEATHER TEMP. SET\ECO MODE 3 items.

Preset Temperature

PRESET TEMP. function is used to set different temperature on different time when the heat mode or cool mode is on.

PRESET TEMP.= PRESET TEMPERATUER

PRESET TEMP. = Preset Temperature

The PRESET TEMP. function will be off in these conditions.

- 1 AUTO mode is running.
- 2 TIMER or WEEKLY SCHEDULE is running.

Go to MENU > PRESET TEMPERATURE > PRESET TEMP.

Press OK.

The following page will appear

PRESET TEMPERATURE			1/2
PRESET TEMP.	WEATHER TEMP.SET	ECO MODE	
NO.	TIME	TEMP.	
1	<input type="checkbox"/>	00:00 25°C	
2	<input type="checkbox"/>	00:00 25°C	
3	<input type="checkbox"/>	00:00 25°C	
			⏪ ⏩

PRESET TEMPERATURE			2/2
PRESET TEMP.	WEATHER TEMP.SET	ECO MODE	
NO.	TIME	TEMP.	
4	<input type="checkbox"/>	00:00 25°C	
5	<input type="checkbox"/>	00:00 25°C	
6	<input type="checkbox"/>	00:00 25°C	
			⏪ ⏩

When double zone is activated,The PERSET TEMP. function only works for zone 1.

Press **LEFT** , **RIGHT**, **Down**, **UP** to scroll and press **Down**, **UP** to adjust the time and the temperature.

When the cursor is on 'n', as the following page

PRESET TEMPERATURE			1/2
PRESET TEMP.	WEATHER TEMP.SET	ECO MODE	
NO.	TIME	TEMP.	
1	<input checked="" type="checkbox"/>	00:00 25°C	
2	<input type="checkbox"/>	00:00 25°C	
3	<input type="checkbox"/>	00:00 25°C	
OK <input checked="" type="checkbox"/> SELECT			⏪ ⏩



You press OK, and the n becomes.
 The timer 1 is selected.
 You press OK again, and the becomes n.
 The timer 1 is unselected.
 Press **LEFT** , **RIGHT**, **Down**, **UP** to scroll and press **Down**, **UP** to adjust the time and the temperature
 Six periods and six temperatures can be set.

For example: Now time is 8:00 and temperature is 35°C.
 The following page will appear

We set the PRESET TEMP as following table.

Information

When the room operation mode is changed, PRESET TEMP. is automatically turned off and the schedule must be set again.
 The PRESET TEMP. function can be used in Heating or Cooling mode.

PRESET TEMPERATURE			1/2
PRESET TEMP.	WEATHER TEMP.SET	ECO MODE	
NO.	TIME	TEMP.	
1	<input checked="" type="checkbox"/>	08:00	35°C
2	<input checked="" type="checkbox"/>	12:00	25°C
3	<input checked="" type="checkbox"/>	15:00	35°C

OK CANCEL

01-01-2018 8:00 13°

08:00	ON	
25 °C		

NO.	TIME	TEMPERATURE
1	8:00	35°C
2	12:00	25°C
3	15:00	35°C
4	18:00	25°C
5	20:00	35°C
6	23:00	25°C

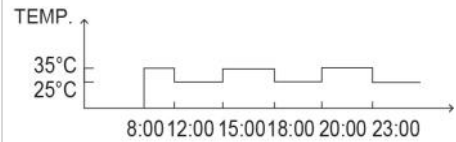



Weather temperature set

WEATHER TEMP. SET= WEATHER TEMPERATURE SET

WEATHER TEMP.SET function is used to preset the desired water flow temperature depending on the outside air temperature.

During the warmer weather the heating is reduced.

To save energy, the weather temp.set can decrease the desired water flow temperature when the outdoor air temperature increased in heating mode.

Go to MENU > PRESET TEMPERATURE > WEATHER TEMP. SET.

Press OK

The following page will appear

PRESET TEMPERATURE		
PRESET TEMP.	WEATHER TEMP.SET	ECO MODE
ZONE1 C-MODE LOW TEMP.		OFF
ZONE1 H-MODE LOW TEMP.		OFF
ZONE2 C-MODE LOW TEMP.		OFF
ZONE2 H-MODE LOW TEMP.		OFF
ON/OFF		ON/OFF

Information

The WEATHER TEMP. SET function is used to select the climate related curves for the various zones and different operation modes.

The possible selections are based on the options set in MENU > FOR SERVICEMAN > COOL MODE SETTING and > HEAT MODE SETTING

If temperature curves are selected, the desired temperature cannot be adjusted.

If you select "ON", the following page will appear

To select the climate related curves, see page 69

Press **LEFT** , **RIGHT**, to scroll .

Press "OK" to select.

WEATHER TEMP. SET	
WEATHER TEMP. SET TYPE:	
1	2
3	4
5	6
7	8
9	
OK CONFIRM	

PRESET TEMPERATURE		
PRESET TEMP.	WEATHER TEMP.SET	ECO MODE
ZONE1 C-MODE LOW TEMP.		ON
ZONE1 H-MODE LOW TEMP.		OFF
ZONE2 C-MODE LOW TEMP.		OFF
ZONE2 H-MODE LOW TEMP.		OFF
ON/OFF		ON/OFF



If the WEATHER TEMP.SET is activated, the desired temperature can not be adjusted on the interface.

The following page will appear

Move to "NO", press "OK" to come back to home page, move to "YES", press "OK" to reset the WEATHER TEMP. SET.

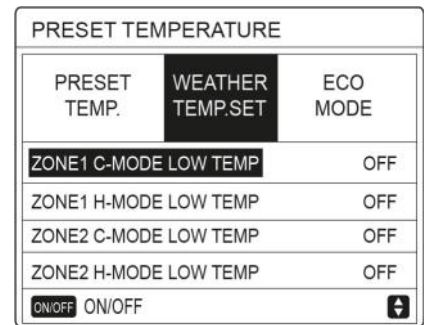
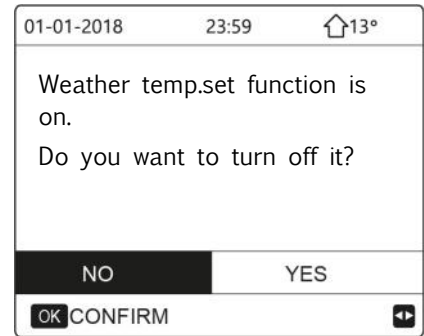

ECO mode

ECO MODE is used to save energy.

The ECO MODE function is activated if DOUBLE ZONE is on NO, if DOUBLE ZONE is on YES, the ECO MODE function is not activated. (see MENU > FOR SERVICEMAN > TEMP. TYPE SETTING)

Go to MENU > PRESET TEMPERATURE > ECO MODE.

Press OK

The following page will appear

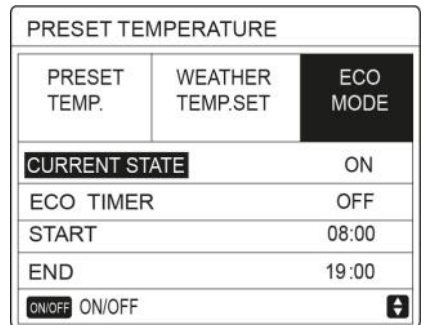

Press "ON/OFF".

The following page will appear

Press **RIGHT** , **LEFT** to scroll

Press "OK" to confirm.

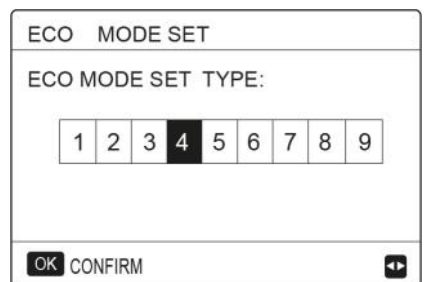

To select the climate related curves, see page 69



The following page will appear:

Press ON/OFF to turn ON or OFF, and press **Up**, **Down** to scroll

When the cursor is on the START or on the END, you can press **LEFT**, **RIGHT**, **Down**, **Up** to scroll and press **Up**, **Down** to adjust the time.

Information

- The desired temperature (T1S) can't be adjusted, when the ECO mode is ON.
- If ECO MODE is ON and ECO TIMER is OFF, the unit run ECO mode all the time.
- If ECO MODE is ON and ECO TIMER is ON, the unit run ECO mode according to the start time and end time.
- When the function is activated, this icon  appears on the keypad

PRESET TEMPERATURE		
PRESET TEMP.	WEATHER TEMP.SET	ECO MODE
CURRENT STATE		ON
ECO TIMER		OFF
START		08:00
END		19:00
ON/OFF		ON/OFF

PRESET TEMPERATURE		
PRESET TEMP.	WEATHER TEMP.SET	ECO MODE
CURRENT STATE		OFF
ECO TIMER		ON
START		08:00
END		19:00
ADJUST		



Domestic Hot Water (DHW)

DHW mode typically consists of the following :

- 1 DISINFECT (anti-legionella)
- 2 FAST DHW
- 3 TANK HEATER
- 4 DHW PUMP (DHW recirculation)

DISINFECT (anti-legionella)

The DISINFECT function is used to kill the legionella.

In disinfect function the tank temperature will be reached 65~70°C forcely. The disinfect temperature is set in DHW MODE

See FOR SERVICEMAN. > DWH MODE > DISINFECT.

Go to MENU > DOMESTIC HOT WATER > DISINFECT.

Press "OK".

The following page will appear

Press **LEFT** , **RIGHT**, **Down**, **UP** to scroll and press **Down**, **UP** to adjust the parameters when setting "OPERATE DAY" and "START".

Example: if the OPERATE DAY is set FRIDAY and the START is set 23:00, the disinfect function will active on 23:00 Friday.

TUT = daily disinfection function

If the disinfect function is running,the following page will appear

In DISINFECT operation the unit does not work towards the system.

DOMESTIC HOT WATER (DHW)			
DIS-INFE	FAST DHW	TANK HEATER	DHW PUMP
CURRENT STATE			ON
OPERATE	DAY		FRI
START	23:00		
⏪ ⏩			



DOMESTIC HOT WATER (DHW)			
DIS-INFE	FAST DHW	TANK HEATER	DHW PUMP
CURRENT STATE			OFF
OPERATE	DAY		FRI
START	23:00		
ON/OFF ⏪			

01-01-2018 🔒		23:59	🏠 13°
🌊	ON	🚰	🌡️
23.5 °C	☀️	38 °C	



FAST DHW

The function is used to force the system to operate in DHW mode. The heat pump and the storage resistance will operate together, and the DHW desired temperature will be brought to the setpoint.

Go to MENU> DOMESTIC HOT WATER > FAST DHW.
Press "OK":

Press "ON/OFF" key to select ON or "OFF".

Information

The FAST DHW function is once effective.

DOMESTIC HOT WATER (DHW)			
DIS-INFECT	FAST DHW	TANK HEATER	DHW PUMP
	FAST DHW		
CURRENT STATE			ON
ON/OFF ON/OFF			



DOMESTIC HOT WATER (DHW)			
DIS-INFECT	FAST DHW	TANK HEATER	DHW PUMP
	FAST DHW		
CURRENT STATE			OFF
ON/OFF ON/OFF			

Tank heater

The tank heater function is used to force the tank heater to heat the water in tank (using the storage resistance) in the same situation, the cooling or heating is required and the heat pump system is operating for cooling or heating, however there still is a demand for the hot water.

Also, even if the heat pump system fails, TANK HEATER can be used to heat water in tank.

Go to MENU > DOMESTIC HOT WATER > TANK HEATER.
Press "OK".

DOMESTIC HOT WATER (DHW)			
DIS-INFECT	FAST DHW	TANK HEATER	DHW PUMP
		TANK HEATER	
CURRENT STATE			ON
ON/OFF ON/OFF			



DOMESTIC HOT WATER (DHW)			
DIS-INFECT	FAST DHW	TANK HEATER	DHW PUMP
		TANK HEATER	
CURRENT STATE			OFF
ON/OFF ON/OFF			



Press "ON/OFF" to select ON or OFF. Use "BACK" to exit.
 If TANK HEATER is effect, the following page will appear

Information

If CURRENT STATE is OFF, TANK HEATER is invalid.
 If the T5(sensor of tank) is fault ,tank heater can't work.

DHW Pump (recirculation) if present

To enable the function choose: MENU > FOR SERVICE MAN > DHW MODE SETTING

Enable parameters:

1.4 DHW PUMP;

1.19 DHW PUMP TIME RUN

The pump is the provided by the Customer

The DHW PUMP function is used to return water of the water net.

Go to MENU > DOMESTIC HOT WATER > DHW PUMP.

Press "OK".

The following page will appear

DIS-INFECT	FAST DHW	TANK HEATER	DHW PUMP
NO.	START	NO.	START
T1 <input type="checkbox"/>	00:00	T4 <input type="checkbox"/>	00:00
T2 <input type="checkbox"/>	00:00	T5 <input type="checkbox"/>	00:00
T3 <input type="checkbox"/>	00:00	T6 <input type="checkbox"/>	00:00

DIS-INFECT	FAST DHW	TANK HEATER	DHW PUMP
NO.	START	NO.	START
T7 <input type="checkbox"/>	00:00	T10 <input type="checkbox"/>	00:00
T8 <input type="checkbox"/>	00:00	T11 <input type="checkbox"/>	00:00
T9 <input type="checkbox"/>	00:00	T12 <input type="checkbox"/>	00:00

Move to "n", press " OK " to select or unselect. (The timer is selected the timer is unselected)

Press **LEFT** , **RIGHT**, **Down**, **UP** to scroll and press **Down**, **UP** to adjust the parameters.

For example:you have set the parameter about the DHW PUMP (see FOR SERVICEMAN > DHW MODE SETTINGS).

PUMP RUNNING TIME is 30 minutes.

Example schedule:

NO.	TIME
1	6:00
2	7:00
3	8:00
4	9:00

The parameter 1.19 DHW PUMP TIME RUN has been set at 30 minutes and the pump will be activated at the following times

DIS-INFECT	FAST DHW	TANK HEATER	DHW PUMP
NO.	START	NO.	START
T1 <input checked="" type="checkbox"/>	00:00	T4 <input type="checkbox"/>	00:00
T2 <input type="checkbox"/>	00:00	T5 <input type="checkbox"/>	00:00
T3 <input type="checkbox"/>	00:00	T6 <input type="checkbox"/>	00:00

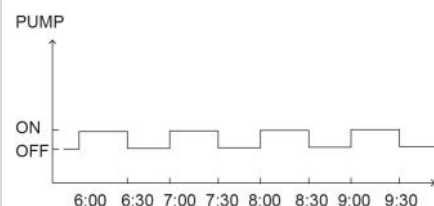



Schedule

SCHEDULE menu contents as follows:

- 1) TIMER for daily programming.
- 2) WEEKLY SCHEDULE for weekly programming.
- 3) SCHEDULE CHECK to check programming
- 4) CANCEL TIMER to cancel programming

TIMER

If weekly schedule is ON and the TIMER function is OFF, the setting that is activated takes precedence over the setting that is not.

If the Timer is activated, ⌚ is displayed on home page.

Press **LEFT** , **RIGHT**, **Down**, **UP** to scroll and press **Down**, **UP** to adjust the time, the mode and the temperature.

Movre to n , press " OK " to select or unselect . (the timer is selected. the timer is unselected.)

Six timers can be set.

If you want to cancel the TIMER, you move the cursor to ,press "OK", the become ,the timer is invalid.

If you set the start time later than the end time or the temperature out of range of the mode, the following page will appear.

Example:

Six timer is set as following:

NO.	START	END	MODE	TEMP
1	1:00	3:00	DHW	50°C
2	7:00	9:00	HEAT	28°C
3	11:30	13:30	COOL	20°C
4	14:30	16:30	HEAT	28°C
5	15:00	19:00	COOL	20°C
6	18:00	23:30	DHW	50°C

The unit will run as following:

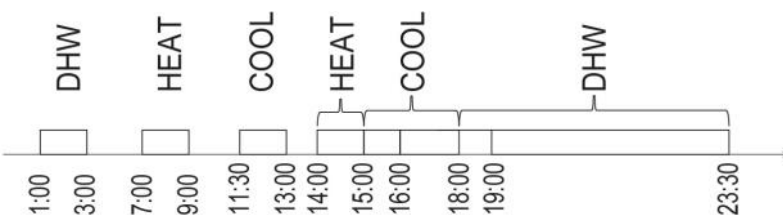

SCHEDULE					1/2
TIMER	WEEKLY SCHEDULE	SCHEDULE CHECK	CANCEL TIMER		
NO.	START	END	MODE	TEMP	
1	<input type="checkbox"/>	00:00	00:00	HEAT	0°C
2	<input type="checkbox"/>	00:00	00:00	HEAT	0°C
3	<input type="checkbox"/>	00:00	00:00	HEAT	0°C
					⬇ ⬆

SCHEDULE					2/2
TIMER	WEEKLY SCHEDULE	SCHEDULE CHECK	CANCEL TIMER		
NO.	START	END	MODE	TEMP	
4	<input type="checkbox"/>	00:00	00:00	HEAT	0°C
5	<input type="checkbox"/>	00:00	00:00	HEAT	0°C
6	<input type="checkbox"/>	00:00	00:00	HEAT	0°C
					⬇ ⬆

SCHEDULE				
TIMER	WEEKLY SCHEDULE	SCHEDULE CHECK	CANCEL TIMER	
Timer1 is useless. Please check the timer setting and temperature setting.				
<input type="button" value="OK"/> CONFIRM				



The operation of the controller at the following time:

TIME	The operation of the controller
1:00	DHW mode is turned ON
3:00	DHW mode is turned OFF
7:00	HEAT MODE is turned ON
9:00	HEAT MODE is turned OFF
11:30	COOL MODE is turned ON
13:00	COOL MODE is turned OFF
14:00	HEAT MODE is turned ON
15:00	COOL MODE is turned ON and HEAT MODE is turned OFF
16:00	HEAT MODE is turned OFF
18:00	DHW MODE is turned ON
19:00	COOL MODE is turned OFF
23:00	DHW mode is turned OFF

Information

If the start time is same to the end time in one timer, the timer is invalid

WEEKLY SCHEDULE

If the timer function is on and the weekly schedule is off, the later setting is effective. If WEEKLY SCHEDULE is activated, 7 is displayed on the home page.

Go to MENU > SCHEDULE > WEEKLY SCHEDULE.

Press "OK".

The following page will appear

First select the days of the week you wish to schedule.

Press **LEFT** or **RIGHT** to scroll through the days, press "OK" to select or unselect the day.

If the day MON means that the day is selected, "MON" means that the day is unselected.

Information

We must set two days at least when we want to enable WEEKLY SCHEDULE function.

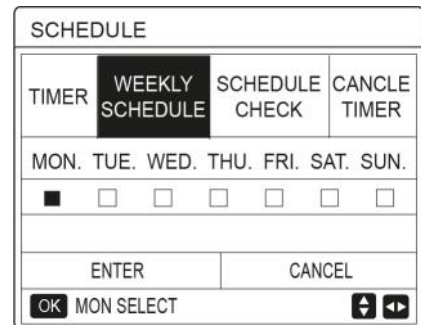



Press **LEFT** or **RIGHT** to scroll through the days, press "OK" to select or unselect the day.

The Monday to Friday are selected to be scheduled and they have the same schedule.

Press **RIGHT** until the cursor is on CONFIRM, then press OK
The following pages will appear

Press **LEFT** , **RIGHT**, **Down**, **UP** to scroll and adjust the time ,the mode and the temperature. Timers can be set, including start time and end time,mode and temperature.

The mode includes heat mode, cool mode and DHW mode.

The setting method refer to timer setting.

The end time must be later than the start time.Otherwise this will show that Timer is useless.

SCHEDULE			
TIMER	WEEKLY SCHEDULE	SCHEDULE CHECK	CANCEL TIMER
MON. TUE. WED. THU. FRI. SAT. SUN.			
<input type="checkbox"/> <input type="checkbox"/> <input type="checkbox"/> <input type="checkbox"/> <input checked="" type="checkbox"/> <input type="checkbox"/> <input type="checkbox"/>			
ENTER		CANCEL	
OK MON SELECT ↕ ↔			

SCHEDULE			
TIMER	WEEKLY SCHEDULE	SCHEDULE CHECK	CANCEL TIMER
MON. TUE. WED. THU. FRI. SAT. SUN.			
<input type="checkbox"/> <input type="checkbox"/> <input type="checkbox"/> <input type="checkbox"/> <input checked="" type="checkbox"/> <input type="checkbox"/> <input type="checkbox"/>			
ENTER		CANCEL	
OK MON SELECT ↕ ↔			

SCHEDULE				1/2	
TIMER	WEEKLY SCHEDULE	SCHEDULE CHECK	CANCEL TIMER		
NO.	START	END	MODE	TEMP	
1	<input type="checkbox"/>	00:00	00:00	HEAT	0°C
2	<input type="checkbox"/>	00:00	00:00	HEAT	0°C
3	<input type="checkbox"/>	00:00	00:00	HEAT	0°C
↕ ↔					

SCHEDULE				2/2	
TIMER	WEEKLY SCHEDULE	SCHEDULE CHECK	CANCEL TIMER		
NO.	START	END	MODE	TEMP	
4	<input type="checkbox"/>	00:00	00:00	HEAT	0°C
5	<input type="checkbox"/>	00:00	00:00	HEAT	0°C
6	<input type="checkbox"/>	00:00	00:00	HEAT	0°C
↕ ↔					

Schedule check

Schedule check can only check the weekly schedule.

go to MENU > SCHEDULE > SCHEDULE. CHECK

Press "OK".

The following page will appear

SCHEDULE			
TIMER	WEEKLY SCHEDULE	SCHEDULE CHECK	CANCEL TIMER
WEEKLY SCHEDULE CHECK			
OK ENTER ↕ ↔			



Press **Down, UP** , the timer from Monday to Sunday will appear

WEEKLY SCHEDULE CHECK						
DAY	NO	MODE	SET	START	END	
MON <input type="checkbox"/>	T1	<input type="checkbox"/>	HEAT	0°C	00:00	00:00
	T2	<input type="checkbox"/>	HEAT	0°C	00:00	00:00
	T3	<input type="checkbox"/>	HEAT	0°C	00:00	00:00
	T4	<input type="checkbox"/>	HEAT	0°C	00:00	00:00
	T5	<input type="checkbox"/>	HEAT	0°C	00:00	00:00
	T6	<input type="checkbox"/>	HEAT	0°C	00:00	00:00

Cancel timer

go to MENU > SCHEDULE > CANCEL TIMER



Press "OK".



The following page will appear



PROGRAM.			
TIMER	PROGRAM. SETTIM.	CONTR. PROGRAM.	ANNULLA TIMER
ANNULLARE TIMER E			
PROGRAMM. SETTIMANALE?			
NO		SI	
OK CONFERMA			

Press **LEFT , RIGHT, Down, UP** to move to "YES" , press OK to cancel timer.



If you want to exit CANCEL TIMER, press "BACK".



If TIMER or WEEKLY SCHEDULE is activated, timer icon  or weekly schedule icon  will display on the home page.

01-01-2018  23:59   13°

	ON	
23.5 °C		38 °C

If TIMER or WEEKLY SCHEDULE is canceled, icon will disappear on the home page.

01-01-2018  23:59  13°

	ON	
23.5 °C		38 °C

Informazioni

You have to reset TIMER/WEEKLY SCHEDULE, if you change the WATER FLOW TEMP. to the ROOM TEMP. or you change the ROOM TEMP. to the WATER FLOW TEMP.

The TIMER or WEEKLY SCHEDULE is invalid, if ROOM THERMOSTAT is effect.



Information

The ECO or COMFORT MODE has the highest priority, the TIMER or WEEKLY SCHEDULE has the second priority and the PRESET TEMP. Or WEATHER TEMP. SET has the lowest priority.

The PRESET TEMP. or WEATHER TEMP. SET becomes invalid, when we set the ECO or COMFORT valid. We must reset the PRESET TEMP. or WEATHER TEMP. SET when we set the ECO or COMFORT invalid.

TIMER or WEEKLY SCHEDULE is invalid when ECO or COMFORT is valid. TIMER or WEEKLY SCHEDULE is activated when the ECO or COMFORT is not running.

TIMER and WEEKLY SCHEDULE are on the same priority. The later setting function is valid. The PRESET TEMP. becomes invalid when TIMER or WEEKLY SCHEDULE is valid. The WEATHER TEMP. SET is not affected by the setting of TIMER or WEEKLY SCHEDULE.

PRESET TEMP. and WEATHER TEMP. SET are on the same priority. The later setting function is valid.

Information

All about the time set items (PRESET TEMP., ECO/COMFORT, DISINFECT, DHW PUMP, TIMER, WEEKLY SCHEDULE, SILENCE MODE, HOLIDAY HOME), the ON/OFF of the corresponding function can be activated from the start time to the end time.



Options

OPTIONS menu contents as following:

- 1) SILENT MODE
- 2) HOLIDAY AWAY
- 3) HOLIDAY HOME
- 4) BACKUP HEATER

Silent mode

The SILENT MODE is used to decrease the sound of the unit. However, it also decreases the heating/cooling capacity of the system. There are two silent mode levels.

level2 is more silent than level1 , and the heating or cooling capacity is also more decreasing.

There are two method to use the silent mode:

- 1 silent mode in all time;
- 2 silent mode in timer.

Go to the home page to check if silent mode is activated. If the silent mode is activated,  will display on the home page.

Go to MENU > OPTIONS > SILENT MODE.

Press "OK"

The following page will appear

Use "ON/OFF" to select ON or OFF.

Description:

If CURRENT STATE is OFF, SILENT MODE is invalid.

When you select SILENT LEVEL, and press "OK" or **RIGHT**

The following page will appear

Press **Down, UP** to select level 1 or level 2.

Press "OK"

OPTIONS				1/2
SILENT MODE	HOLIDAY AWAY	HOLIDAY HOME	BACKUP HEATER	
CURRENT STATE				OFF
SILENT LEVEL				LEVEL 1
TIMER1 START				12:00
TIMER1 END				15:00
ON/OFF				ON/OFF 

OPTIONS				
SILENT MODE	HOLIDAY AWAY	HOLIDAY HOME	BACKUP HEATER	
CURRENT STATE				ON
SILENT LEVEL				LEVEL 1
TIMER1 START				12:00
TIMER1 END				15:00
ADJUST				

LEVEL 1

OPTIONS				
SILENT MODE	HOLIDAY AWAY	HOLIDAY HOME	BACKUP HEATER	
CURRENT STATE				ON
SILENT LEVEL				LEVEL 2
TIMER1 START				12:00
TIMER1 END				15:00
ADJUST				

LEVEL 2



If the silent TIMER is selected, Press "OK" to enter, the following page will appear.

There are two timers for setting.

Move to n, press "OK" to select or unselect.

If the two time are both unselected, the silent mode will operate in all time. Otherwise, it will operate according as the time.

OPTIONS				2/2
SILENT MODE	HOLIDAY AWAY	HOLIDAY HOME	BACKUP HEATER	
TIMER1				OFF
TIMER2 START				22:00
TIMER2 END				07:00
TIMER2				OFF
ADJUST				

Holiday Away

If the holiday away mode is activated,  will display on the home page.

The holiday away function is used to prevent frozen in the winter during the outside holiday, and return the unit before the end of the holiday.

Go to MENU > OPTIONS > HOLIDAY AWAY.

Press "OK"

The following page will appear

OPTIONS				1/2
SILENT MODE	HOLIDAY AWAY	HOLIDAY HOME	BACKUP HEATER	
CURRENT STATE				OFF
DHW MODE				ON
DISINFECT				ON
HEAT MODE				ON
ON/OFF ON/OFF				

Usage example: You go away during the winter. The current date is 2020-01-31, two days later is 2020-02-02, it is the beginning date of the holiday.

- If you are in the following situation:
In 2 days, you go away for 2 weeks during the winter.
- You want to save energy, but prevent your house from freezing.

Then you can do the following:

- 1) Configure the holiday away the following settings
- 2) Activate the holiday mode.

Go to MENU > OPTIONS > HOLIDAY AWAY.

Press "OK" .

Press "ON/OFF" to select "OFF" or "ON" and press **LEFT** , **RIGHT**, **Down**, **UP** to scroll and adjust.

OPTIONS				2/2
SILENT MODE	HOLIDAY AWAY	HOLIDAY HOME	BACKUP HEATER	
FROM				00-00-2000
UNTIL				00-00-2000
ADJUST				

Settings	Value
Holiday away	ON
From	2 February 2020
Until	16 February 2020
Operation mode	Heating
Disinfect	ON

Information

If DHW mode in holiday away mode is ON, The disinfect set by user is invalid.



If holiday away mode is ON, The timer and weekly schedule are invalid except exit.
 If the CURRENT STATE is OFF,the HOLIDAY AWAY is OFF.
 If the CURRENT STATE is ON,the HOLIDAY AWAY is ON.
 The remote control doesn't accept any orders when holiday away mode is ON.
 Disinfecting the unit on 23:00 of the last day if disinfect is ON.
 When in holiday away mode, the climate related curves previously set is invalid, and the curves will automatically take effect after the holiday away mode is ends.
 The preset temperature is invalid when in holiday away mode, but the preset value still display on the main page.

Holiday home

The HOLIDAY HOME function is used to program up to 6 programs without changing the normal schedules when holidaying at home.
 During your holiday, you can use the holiday mode to deviate from your normal schedules without having to change them.

Period	Programming
Before and after your holiday	Your normal schedules will be used.
During your holiday	The configured holiday settings will be used.

If the holiday home mode is activated,  will display on the home page.

Go to MENU > OPTIONS > HOLIDAY HOME
 Press "OK"
 The following page will appear
 Select Holiday home
 Press **Down**
 Press "ON/OFF" to select "OFF" or "ON"
 If the CURRENT STATE is OFF, the HOLIDAY HOME is OFF
 If the CURRENT STATE is ON, the HOLIDAY HOME is ON.
 Press **Down** to adjust the date.
 Press **LEFT , RIGHT, Down, UP** to scroll and adjust values.
 Press "OK"

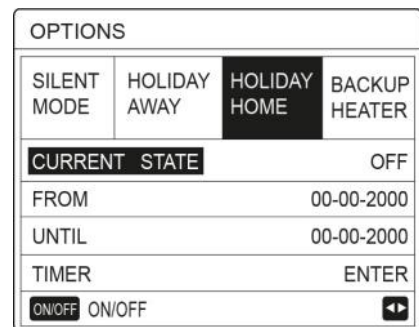



The following page will appear

Press **LEFT** , **RIGHT**, **Down**, **UP** to scroll and press **Down**, **UP** to adjust the time, the mode and the temperature.

Move to n , press " OK " to select or unselect (the timer is selected. the timer is unselected.)

If you want to cancel the TIMER, you move the cursor to ,press "OK", the become ,the timer is invalid.

If you set the start time later than the end time or the temperature out of range of the mode, the following page will appear.

Before and after your holiday, your normal schedule will be used. During your holiday, you save energy and prevent your house from freezing.

Information

You have to reset Holiday away or Holiday home, if you change the operation mode of the unit.

OPTIONS					1/2
SILENT MODE	HOLIDAY AWAY	HOLIDAY HOME	BACKUP HEATER		
N.	START	END	MODE	TEMP	
1 <input type="checkbox"/>	00:00	00:00	HEAT	0°C	
2 <input type="checkbox"/>	00:00	00:00	HEAT	0°C	
3 <input type="checkbox"/>	00:00	00:00	HEAT	0°C	

OPTIONS					2/2
SILENT MODE	HOLIDAY AWAY	HOLIDAY HOME	BACKUP HEATER		
NO.	START	END	MODE	TEMP	
4 <input type="checkbox"/>	00:00	00:00	HEAT	0°C	
5 <input type="checkbox"/>	00:00	00:00	HEAT	0°C	
6 <input type="checkbox"/>	00:00	00:00	HEAT	0°C	

OPZIONI			
SILENT MODE	HOLIDAY AWAY	HOLIDAY HOME	BACKUP HEATER
Timer1 is useless. Please check the timer setting and temperature setting.			
OK CONFIRM			

Backup Heater (Currently not available)

The BACKUP HEATER function is used to force the backup heater. Go to MENU > OPTIONS > BACKUP HEATER.

Press "OK" .

If IBH and AHS is set invalid by DIP switch on the main control board of hydraulic module, the following page will appear

IBH= Indoor unit backup heater.

AHS= Additional heating source.

If IBH and AHS is set valid by DIP switch on the main control board of hydraulic module, the following page will appear.

Use "ON/OFF" to select "OFF" or "ON"

Information

If the operation mode is auto mode in space heating or cooling side, the buckup heater function can not be selected.

The BACKUP HEATER function is invalid when only ROOM HEAT MODE enabled.

OPTIONS			
SILENT MODE	HOLIDAY AWAY	HOLIDAY HOME	BACKUP HEATER

OPTIONS			
SILENT MODE	HOLIDAY AWAY	HOLIDAY HOME	BACKUP HEATER
BACKUP HEATER			ON
ON/OFF ON/OFF			



Child Lock

The CHILD Lock function is used to prevent children error operation. The mode setting and temperature adjusting can be locked or unlocked by using CHILD LOCK function.

Go to MENU > CHILD LOCK.

The page is displayed

Input the corrent password, the following page will appear:

Press **Down**, **UP** scroll and" ON/OFF" to select LOCK or UNLOCK.

The cool/heat temperature can't be adjusted when the COOL/HEAT TEMP. ADJUST is locked.

If you want to adjust the cool/heat temperature when cool/heat temperature is locked,the following page will appear

The cool/heat mode can't turn on or off when the COOL/HEAT MODE ON/OFF is locked.

If you want to turn on or off the cool/heat mode when COOL/HEAT MODE ON/OFF is locked,the following page will appear

The DHW temperature can't be adjusted when the DHW TEMP. ADJUST is locked.If you want to adjust the DHW temperature when DHW TEMP. ADJUST is locked,the following page will appear

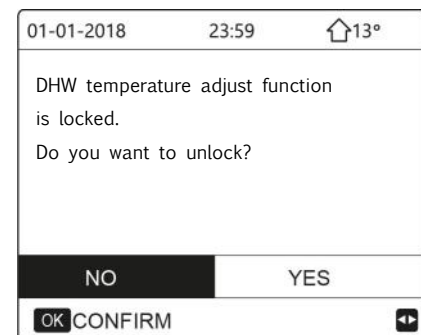
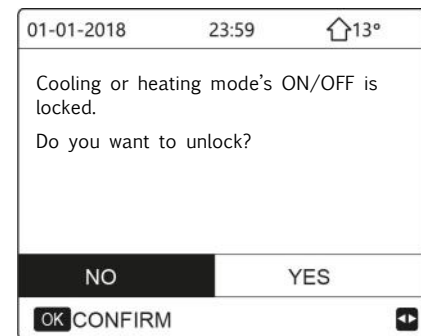
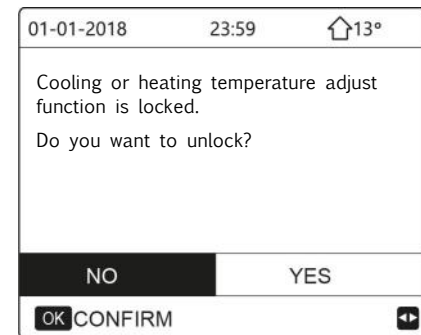
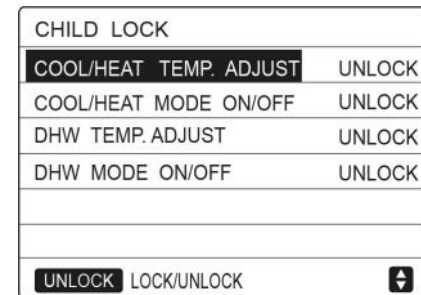
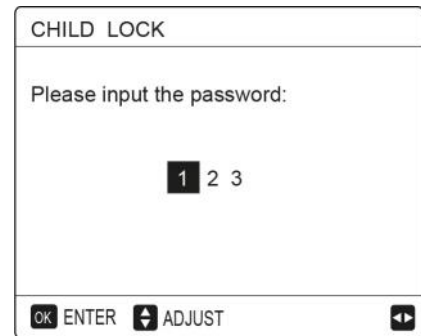



The DHW mode can't turn on or off when the DHW MODE ON/OFF is locked.If you want to turn on or off the DHW mode when DHW MODE ON/OFF is locked,the following page will appear:

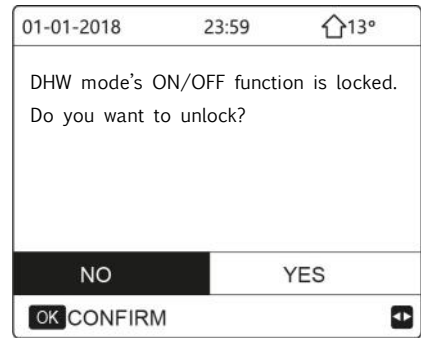

Service information

About service information

Service information menu contents as following:

- 1 service call: displays the contacts needed to call for assistance;
- 2 error code: displays the meaning of the error codes;
- 3 parameter: used to control the operating parameters;
- 4 display: used to configure the display.

How to go to service information menu

Go to MENU > SERVICE INFORMATION.

Press "OK".

The following page will appear

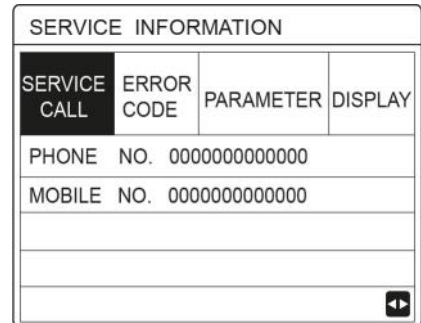

The service call can show the service phone or mobile number.

The installer can input the phone number. See "FOR SERVICEMAN".

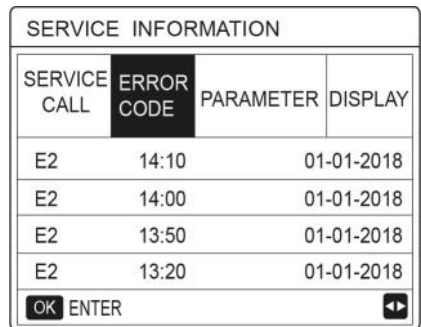

Error code is used to show when the fault or proction happen and show the mean of the error code.

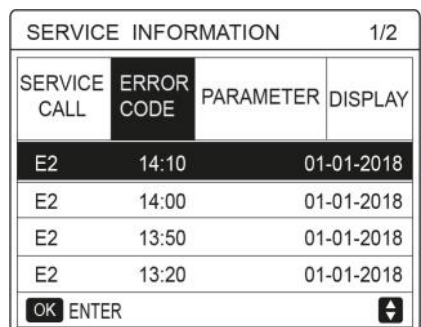

Press OK the page will appear

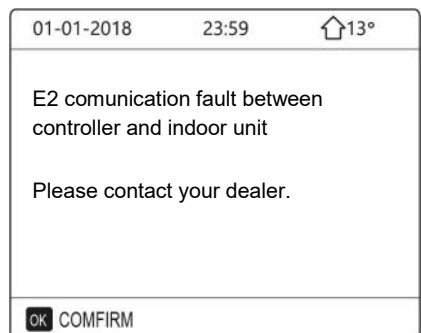

Press OK to show the mean of the error code

Information

A total of eight fault codes can be recorded.



The parameter function is used to display the main parameter, there are two pages to show the parameter:

SERVICE INFORMATION		2/2
SERVICE CALL	ERROR CODE	PARAMETER DISPLAY
MAIN ACTUAL TEMP.		26°C
TANK ACTUAL TEMP.		55°C
SMART GRID RUNNING TIME		0 Hrs

SERVICE INFORMATION		1/2
SERVICE CALL	ERROR CODE	PARAMETER DISPLAY
ROOM SET TEMP.		26°C
MAIN SET TEMP.		55°C
TANK SET TEMP.		55°C
ROOM ACTUAL TEMP.		24°C

The DISPLAY function is used to set the interface

Press "OK" to enter and press **LEFT** , **RIGHT**, **Down**, **UP** to scroll.

SERVICE INFORMATION		1/2
SERVICE CALL	ERROR CODE	PARAMETER DISPLAY
TIME		12:30
DATE		08-08-2018
LANGUAGE		EN
BACKLIGHT		ON
OK ENTER		◀▶

SERVICE INFORMATION		2/2
SERVICE CALL	ERROR CODE	PARAMETER DISPLAY
BUZZER		ON
SCREEN LOCK TIME		120SEC
SMART GRID RUNNING TIME		2 Hrs
ON/OFF ON/OFF		↕

Operation Parameter



This menu Operation parameter is for installer or service engineer reviewing the operation parameter.

The values shown on the screens are only indicative

At home page, go to MENU > OPERATION PARAMETER.

Press "OK".

Press "OK". There are six pages for the operating parameter as following.

Press **Down**, **UP** to scroll.

OPERATION PARAMETER		#00
ONLINE UNITS NUMBER		1
OPERATE MODE		COOL
SV1 STATE		ON
SV2 STATE		OFF
SV3 STATE		OFF
PUMP_I		ON
◀ ADDRESS		1/9 ▶



Information

The power consumption parameter is preparatory.
if some parameter not be activated in the system, the parameter will show "--"

The heat pump capacity is for reference only, not used to judge the ability of the unit. The accuracy of sensor is $\pm 1^{\circ}\text{C}$ The flow rates parameters are calculated according to the pump running parameters, the deviation is different at different flow rates, the maximum of deviation is 15%.

OPERATION PARAMETER	#00
PUMP_O	OFF
PUMP_C	OFF
PUMP_S	OFF
PUMP_D	OFF
PIPE BACKUP HEATER	OFF
TANK BACKUP HEATER	ON
ADDRESS	2/9

OPERATION PARAMETER	#00
GAS BOILER	OFF
T1 LEAVING WATER TEMP.	35°C
WATER FLOW	1.72m ³ /h
HEAT PUMP CAPACTIY	11.52kW
POWER CONSUM	1000kWh
Ta ROOM TEMP.	25°C
ADDRESS	3/9

OPERATION PARAMETER	#00
T5 WATER TANK TEMP.	53°C
T1B CIRCUIT2 WATER TEMP.	35°C
TIS' C1 CLI. CURVE TEMP.	35°C
TIS2' C2 CLI. CURVE TEMP.	35°C
TW_O PLATE W-OUTLET TEMP.	35°C
TW_I PLATE W-INLET TEMP.	30°C
ADDRESS	4/9

OPERATION PARAMETER	#00
Tbt1 BUFFERTANK_UP TEMP.	35°C
Tbt2 BUFFERTANK_LOW TEMP.	35°C
Tsolar	25°C
IDU SOFTWARE	01-09-2019V01
ADDRESS	5/9

OPERATION PARAMETER	#00-
ODU MODEL	6kW
COMP.CURRENT	12A
COMP.FREQENCY	24Hz
COMP.RUN TIME	54 MIN
COMP.TOTAL RUN TIME	1000Hrs
EXPANSION VALVE	200P
ADDRESS	6/9



OPERATION PARAMETER	#00
FAN SPEED	600R/MIN
IDU TARGET FREQUENCY	46Hz
FREQUENCY LIMITED TYPE	5
SUPPLY VOLTAGE	230V
DC GENERATRIX VOLTAGE	420V
DC GENERATRIX CURRENT	18A
ADDRESS	7/9

OPERATION PARAMETER	#00
TW_O PLATE W-OUTLET TEMP.	35°C
TW_I PLATE W-INLET TEMP.	30°C
T2 PLATE F-OUT TEMP.	35°C
T2B PLATE F-IN TEMP.	35°C
Th COMP. SUCTION TEMP.	5°C
Tp COMP. DISCHARGE TEMP.	75°C
ADDRESS	8/9

OPERATION PARAMETER	#00
T3 OUTDOOR EXCHANGE TEMP.	5°C
T4 OUTDOOR AIR TEMP.	5°C
TF MODULE TEMP.	55°C
P1 COMP. PRESSURE	2300kPa
ODU SOFTWARE	01-09-2018V01
HMI SOFTWARE	01-09-2018V01
ADDRESS	9/9

For Serviceman



About For Serviceman

FOR SERVICEMAN is used for installer and service engineer.

- Setting the function of equipment.
- Setting the parameters.

How To Go To For Serviceman

Go to MENU > FOR SERVICEMAN.

Press "OK".

The FOR SERVICEMAN is used for installer or service engineer. It is NOT intended the home owner alters setting with this menu.

It is for this reason password protection is required to prevent unauthorised access to the service settings.

FOR SERVICEMAN

Please input the password:

0 0 0

OK ENTER ADJUST SCROLL



How To Exit For SERVICEMAN

If you have set all the parameter.
Press "BACK", the following page will appear

Select "YES" and press "OK" to exit the FOR SERVICEMAN.
After exiting the FOR SERVICEMAN, the unit will be turned off.

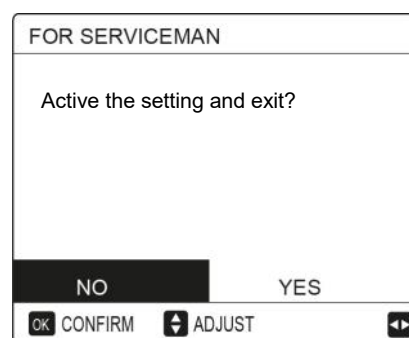

Network Configuration Guidelines

The wired controller realizes intelligent control with a built-in module, which receives control signal from the APP.

Before connecting the WLAN, please check for it if the router in your environment is active and make sure that the wired controller is well-connected to the wireless signal.

During the Wireless distribution process, the LCD icon flashes to indicate that the network is being deployed. After the process is completed, the icon will be constantly on.

Wired Controller Setting

The wired controller settings include AP MODE and RESTORE WLAN SETTING.

Activate the WLAN by interface.
Go to MENU > WLAN SETTING > AP MODE.
Press "OK", the following page will appear

Press **LEFT** , **RIGHT**, to move to"YES", press "OK" to select AP mode.

Select AP Mode correspondingly on the mobile device and continue the follow-up settings according to the APP prompts.

Caution

After enter Ap mode, if it's not connected with mobile phone, the LCD icon will flash 10 minutes then disappear.

If it's connected with the mobile phone, the icon will be constantly display.

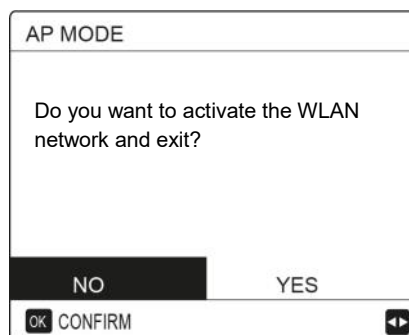
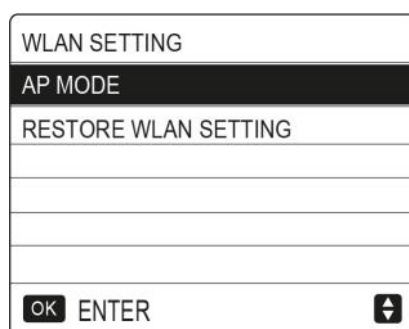



Restore WLAN setting by interface.

Go to MENU > WLAN SETTING > RESTORE WLAN SETTING .

Press "OK", the following page will appear

Press **LEFT** , **RIGHT**, to move to "YES", press "OK" to restore WLAN setting. Complete the above operation and wireless configuration is reset.

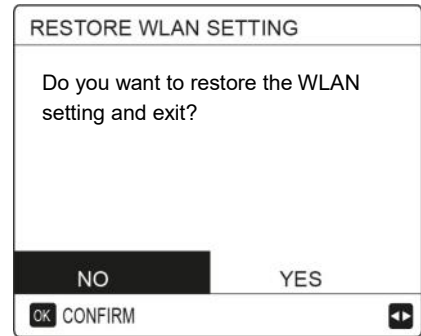

SN view

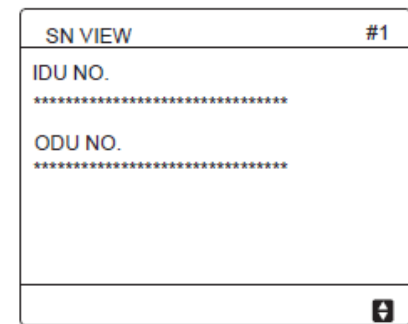
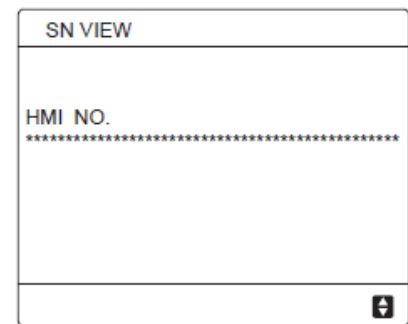



Mobile Device Setting

AP Mode is available for wireless distribution on mobile device side.
AP Mode connecting WLAN:

- Install APP
- Scan the following QR code to install the Smart Home APP.
- Please research "Msmartlife" in APP STORE or GOOGLE PLAY to install the APP.

Sign in/Sign up

Click the "+" button on the right side of the home page , register account according to the guide.

Add Home Appliances

1) Choose the wired controller model, then go to add the device

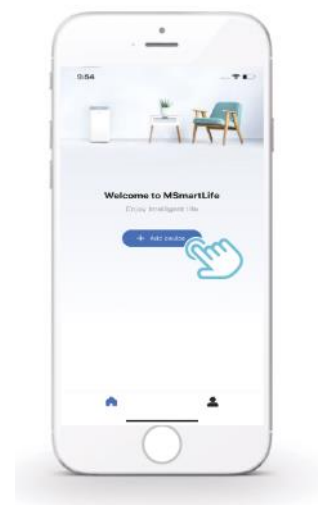



2) Operate the wired controller according to APP prompts.



3) Wait for the home appliance to connect, and click "Finish".

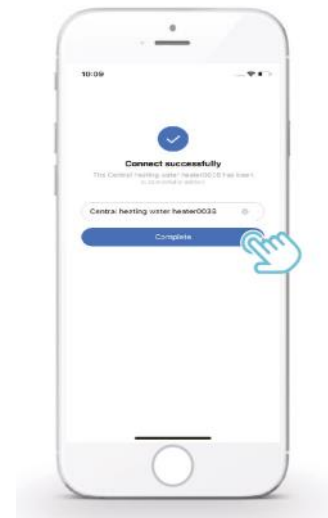

4) After the appliance is successfully connected, the LCD icon WIFI of the wired controller is constantly on, and the air conditioner can be controlled through the APP.

5) If the network distribution process fails, or the mobile connection demands reconnection and replacement, operate "WiFi Factory Reset" on the wired controller, and then repeat the above process.

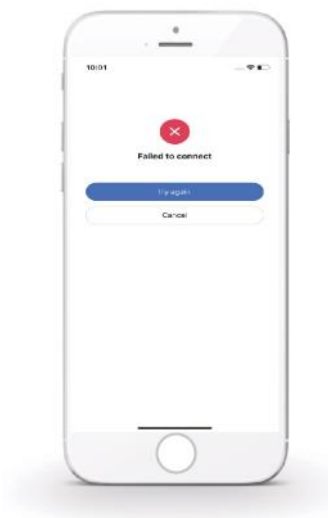



Warning and troubleshooting for networking failures

- When the product is connected to the network, please make sure that the phone is as close as possible to the product.
- We only support 2.4GHz band routers at present.
- Special characters (punctuation, spaces, etc.) are not recommended as part of the Wifi name.
- It is recommended that you connect no more than 10 devices to a single router lest home appliances are affected by weak or unstable network signal.
- If the password of the router or Wifi is changed, clear all settings and reset the appliance.
- The contents of APP might change in version updates and actual operation shall prevail.

Wi-Fi network access from mobile phone

Select the Wi-Fi network.

Enter password: 12345678





Table1 The outside temperature curve of the low temperature setting for heating

T4	≤ -20	-19	-18	-17	-16	-15	-14	-13	-12	-11	-10	-9	-8	-7	-6	-5	-4	-3	-2	-1	0
1- T1S	38	38	38	38	38	37	37	37	37	37	37	36	36	36	36	36	36	35	35	35	35
2- T1S	37	37	37	37	37	36	36	36	36	36	36	35	35	35	35	35	35	34	34	34	34
3- T1S	36	36	36	35	35	35	35	35	35	34	34	34	34	34	34	33	33	33	33	33	33
4- T1S	35	35	35	34	34	34	34	34	34	33	33	33	33	33	33	32	32	32	32	32	32
5- T1S	34	34	34	33	33	33	33	33	33	32	32	32	32	32	32	31	31	31	31	31	31
6- T1S	32	32	32	32	31	31	31	31	31	31	31	31	30	30	30	30	30	30	30	30	29
7- T1S	31	31	31	31	30	30	30	30	30	30	30	30	29	29	29	29	29	29	29	29	28
8- T1S	29	29	29	29	28	28	28	28	28	28	28	28	27	27	27	27	27	27	27	27	26
T4	1	2	3	4	5	6	7	8	9	10	11	12	13	14	15	16	17	18	19	≥ 20	
1- T1S	35	35	34	34	34	34	34	34	33	33	33	33	33	33	32	32	32	32	32	32	32
2- T1S	34	34	33	33	33	33	33	33	32	32	32	32	32	32	31	31	31	31	31	31	31
3- T1S	32	32	32	32	32	32	31	31	31	31	31	31	30	30	30	30	30	30	29	29	29
4- T1S	31	31	31	31	31	31	30	30	30	30	30	30	29	29	29	29	29	29	28	28	28
5- T1S	30	30	30	30	30	30	29	29	29	29	29	29	28	28	28	28	28	28	27	27	27
6- T1S	29	29	29	29	29	29	28	28	28	28	28	28	27	27	27	27	27	27	26	26	26
7- T1S	28	28	28	28	28	28	27	27	27	27	27	27	26	26	26	26	26	26	25	25	25
8- T1S	26	26	26	26	26	26	26	25	25	25	25	25	25	25	25	24	24	24	24	24	24

Table2 The outside temperature curve of the low temperature setting for heating

T4	≤ -20	-19	-18	-17	-16	-15	-14	-13	-12	-11	-10	-9	-8	-7	-6	-5	-4	-3	-2	-1	0
1- T1S	55	55	55	55	54	54	54	54	54	54	54	54	53	53	53	53	53	53	53	53	52
2- T1S	53	53	53	53	52	52	52	52	52	52	52	52	51	51	51	51	51	51	51	51	50
3- T1S	52	52	52	52	51	51	51	51	51	51	51	51	50	50	50	50	50	50	50	50	49
4- T1S	50	50	50	50	49	49	49	49	49	49	49	49	48	48	48	48	48	48	48	48	47
5- T1S	48	48	48	48	47	47	47	47	47	47	47	47	46	46	46	46	46	46	46	46	45
6- T1S	45	45	45	45	44	44	44	44	44	44	44	44	43	43	43	43	43	43	43	43	42
7- T1S	43	43	43	43	42	42	42	42	42	42	42	42	41	41	41	41	41	41	41	41	40
8- T1S	40	40	40	40	39	39	39	39	39	39	39	39	38	38	38	38	38	38	38	38	37
T4	1	2	3	4	5	6	7	8	9	10	11	12	13	14	15	16	17	18	19	≥ 20	
1- T1S	52	52	52	52	52	52	52	51	51	51	51	51	51	51	51	50	50	50	50	50	50
2- T1S	50	50	50	50	50	50	50	49	49	49	49	49	49	49	49	48	48	48	48	48	48
3- T1S	49	49	49	49	49	49	49	48	48	48	48	48	48	48	48	47	47	47	47	47	47
4- T1S	47	47	47	47	47	47	47	46	46	46	46	46	46	46	46	45	45	45	45	45	45
5- T1S	45	45	45	45	45	45	45	44	44	44	44	44	44	44	44	43	43	43	43	43	43
6- T1S	42	42	42	42	42	42	42	41	41	41	41	41	41	41	41	40	40	40	40	40	40
7- T1S	40	40	40	40	40	40	40	39	39	39	39	39	39	39	39	38	38	38	38	38	38
8- T1S	37	37	37	37	37	37	37	36	36	36	36	36	36	36	36	35	35	35	35	35	35



The automatic setting curve

The automatic setting curve is the ninth curve, this is the calculation:

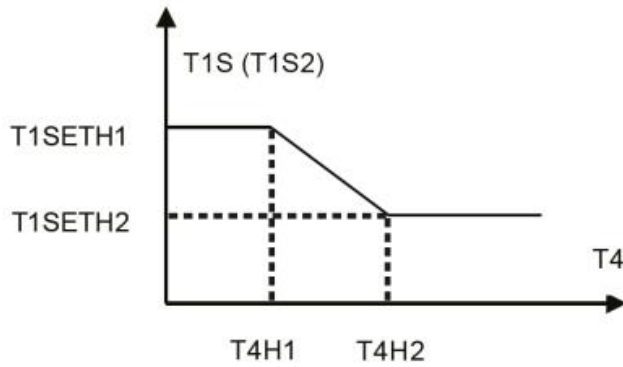

State: setting from wired controller, if $T4H2 < T4H1$, exchange value; if $T1SETH1 < T1SETH2$, exchange value.

Table3 The outside temperature curve of the low temperature setting for cooling

T4	$-10 \leq T4 < 15$	$15 \leq T4 < 22$	$22 \leq T4 < 30$	$30 \leq T4$
1- T1S	16	11	8	5
2- T1S	17	12	9	6
3- T1S	18	13	10	7
4- T1S	19	14	11	8
5- T1S	20	15	12	9
6- T1S	21	16	13	10
7- T1S	22	17	14	11
8- T1S	23	18	15	12

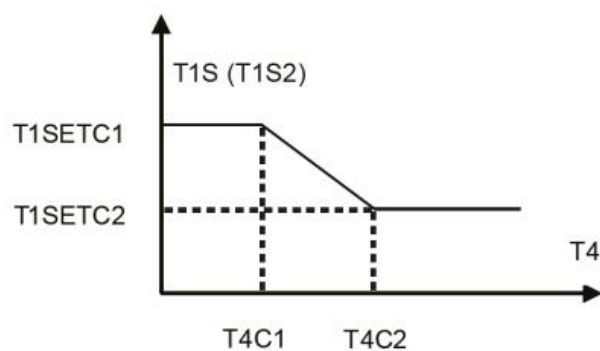

Table4 The outside temperature curve of the high temperature setting for cooling

4	$-10 \leq T_4 < 15$	$15 \leq T_4 < 22$	$22 \leq T_4 < 30$	$30 \leq T_4$
1- T1S	20	18	17	16
2- T1S	21	19	18	17
3- T1S	22	20	19	17
4- T1S	23	21	19	18
5- T1S	24	21	20	18
6- T1S	24	22	20	19
7- T1S	25	22	21	19
8- T1S	25	23	21	20

The automatic setting curve

The automatic setting curve is the ninth curve, this is the calculation:



State: In the setting the wired controller, if $T4C2 < T4C1$, then exchange their value; if $T1SETC1 < T1SETC2$, then exchange their value.



Commands

Register address	Data content	Remarks	
0	ON/OFF	bit15	Reserved
		bit14	Reserved
		bit13	Reserved
		bit12	Reserved
		bit11	Reserved
		bit10	Reserved
		bit9	Reserved
		bit8	Reserved
		bit7	Reserved
		bit6	Reserved
		bit5	Reserved
		bit4	Reserved
		bit3	0: OFF (T2S); 1: ON (T2S) (WATER FLOW TEMP control -Zone 2)
		bit2	0: DHW(T5S) OFF ; 1: DHW(T5S) ON
		bit1	0: OFF (T1S) ; 1: ON (T1S) (WATER FLOW TEMP control -Zone 1)
bit0	0: OFF (TS) ; 1: ON (TS) (ROOM TEMP thermostat control)		
1	Mode setting	1: auto mode; 2: Cooling ;3: heating ;other value: Invalid	
2	Set the water temperature T1s	bit8-bit15	Setting water temperature T1s corresponding to ZONE 2
		bit0-bit7	Setting water temperature T1s corresponding to ZONE 1
3	Setting air temperature Ts	Room tem. Setting , 17°C ~30°C if Ta is enabled ; Read=real*2; for example: set= 17.5°C , read= 35	
4	T5s	Water tank setting , 20°C ~ 60/75°C (Sphera A with AHS can be set to 75 , other unit for 60) default = 50	
5	Function setting	bit15	Reserved
		bit14	Reserved
		bit13	1: Zone 2 curve enable ; 0: Zone 2 curve disable
		bit12	1: Zone 1 curve enable ; 0: Zone 1 curve disable
		bit11	DHW pump return pump
		bit10	ECO mode
		bit9	Reserved
		bit8	Holiday home (read only , can not write)
		bit7	0 : silent mode level1 , 1: silent mode level2
		bit6	Silent mode
		bit5	Holiday away (read only , can not write)
		bit4	Sterilization (disinfect)
		bit3	Reserved
		bit2	Reserved
		bit1	Reserved
bit0	Reserved		
6	Curve selection	bit8-bit15 :	ZONE 2 Curve 1- 9
		bit0-bit7	ZONE 1 Curve 1- 9
7	Forced hot water	0 : disable	TBH is for tank heater.
8	Force TBH	1 : Forced ON	IBH is for system
9	Force IBH	2 : Forced OFF	TBH and IBH cannot be forced together
10	0-24hrs		
11	Set the water tempera-	Setting water temperature T1s corresponding to ZONE 1	
12	Set the water tempera-	Setting water temperature T1s corresponding to ZONE 2	



Stata

Register address	Signification	Description
100	Operating frequency	Compressor operating frequency in Hz. Send value = actual value
101	Operating mode	The actual operating mode of the whole machine. 0= OFF 3= cooling 0= heating
102	Fan speed	Fan speed, unit r/min. Send value = actual speed
103	PMV opening	Outside the unit electronic expansion valve opening degree, the unit: P. Send value = actual value (show only 8 multiples Only Multiples of 8 Will BE Shown)
104	Inlet water temperature	TW_in, unit: °C. Send value = actual value
105	Outlet water temperature	TW_out, unit: °C. Send value = actual value
106	T3 temperature	Condenser temperature in °C. Send value = actual value
107	T4 temperature	Outside temperature in °C. Send value = actual value
108	Exhaust gas temperature	Compressor exhaust temperature Tp, in °C. Send value = actual value
109	Return gas temperature	Back to the compressor temperature Th, unit: °C. Send value = actual value
110	T1	Water outlet temperature of the backup heater or additional heating source (IBH and/or AHS)
111	T1B	Flow water temperature for low-temperature zone (only in case of 2-zone kit)
112	T2	The temperature of the refrigerant liquid side, unit: °C. Send value = actual value
113	T2B	Refrigerant gas side temperature, unit: °C. Send value = actual value
114	Ta	Indoor temperature , unit: °C Send value =actual value
115	T5	Water tank temperature
116	Pressure value 1	ODU high pressure value, unit: kPa .Send value = true value
117	Pressure value 2	ODU low pressure value, unit: kPa .Send value = true value (reserved)
118	ODU current	ODU operation current, unit A, sending value = actual value
119	ODU voltage	ODU voltage unit: V. Send value = actual value (reserved)
120	Tbt1	Tbt1 , unit: °C. Send value = actual value
121	Tbt2	Tbt2 , unit: °C. Send value = actual value
122	Compressor running time	Compressor operation time, unit: hour, send value = actual value
123	Unit	The 200 register is reserved for type 0702, and the value for type 071X represents type capacity 4-30 represents 4-30KW
124	Current fault	Specific fault code, refer to the code table.
125	Fault 1	
126	Fault 2	
127	Fault 3	



128	Status bit 1	BIT15	Ask for installation parameter, 1: ask for; 0: not ask for
		BIT14	Upload software version, 1: ask for ;0: not ask for
		BIT13	Upload SN, 1: ask for 0: not ask for
		BIT12	Reserved
		BIT11	EVU 1: free electrical 0:based on SG signal
		BIT10	SG 1: normal electrical price 0 : high electrical price
		BIT9	Water tank anti-freezing
		BIT8	Solar input
		BIT7	Room thermostat cool
		BIT6	Room thermostat heat
		BIT5	ODU test mode
		BIT4	Remote ON/OFF (1 : d8)
		BIT3	Oil return
		BIT2	Anti-freeze
		BIT1	Defrost
		BIT0	Recirculation pump
129	Load output	BIT15	DEFROST
		BIT14	External heat source
		BIT13	ON Compressor
		BIT12	ALARM
		BIT11	Solar pump Pump_S
		BIT10	HEAT4
		BIT9	SV3
		BIT8	Mix pump P_C
		BIT7	Recirculation pump P_D
		BIT6	External pump P_o
		BIT5	SV2
		BIT4	SV1
		BIT3	Water pump PUMP_I
		BIT2	TBH
		BIT1	IBH2
BIT0	IBH		
130	Software version of internal unit	0 - 99 The software version of the internal unit	
131	Software version of the user interface	0 - 99 The software version of the user interface	
132	Unit target frequency	Frequency	
133	DC bus current	Unit: Ampere	
134	DC bus voltage	Return value = actual value / 10 (Unit: Volt)	

10 CONTROL



135	TF module temperature	Units (°C) - Outside unit feedback
136	Curve 1 T1S	Actual value - Registration result corresponding to area 1
137	Curve 2 T1S	Actual value --- Calculation result corresponding to area 2
138	Water flow	Actual value *100 units: M3/H
139	ODU current limit scheme	Scheme value ----- Outside machine feedback 174
140	IDU capacity	Actual value *100 units: kW
141	T solar	
142	Number of cascade units	BIT1-BIT15 represents 1-1 5 unit online/offline status BIT0 Reserved
143	High bit of electrical	Power consumption
144	Low bit of electrical	
145	High bit of heat	System heating capacity
146	Low bit of heat	
147	A series-Sphera AHS volta- ge output	Actual value *10 units: kW



Allarms

In case of maloperations the alarms are indicated by the 'Alarm in progress' symbol on the multifunctional keypad.

To view the alarms select Menu ► Service information

To reset the alarm remove its cause and reset the active alarm.

Before resetting an alarm identify and remove the cause that generate it.

Repeated reset can cause irreversible damages as maloperation of the system itself.

In case of doubt please contact an Assistance Centre.

	Description	Modbus code	Unit
E0	Water flow failure (3 times water flow failure)	1	IDU
E1	Or zero phaseline-to-line phase error (three-phase models have this fault code)	33	ODU
E2	User interface and hydraulic module communication failure	2	IDU
E3	T1 water outlet temperature sensor failure	4	IDU
E4	T5 water tank temperature sensor failure	5	IDU
E5	Outdoor unit T3 temperature sensor failure	39	ODU
E6	Outdoor unit T4 ambient temperature sensor failure	40	ODU
E7	Tbt1 balance water tank upper sensor failure	6	IDU
E8	Water flow failure (is displayed within three times, and can be recovered after minutes)	9	IDU
E9	Th temperature sensor failure	41	ODU
EA	Outdoor unit Tp row Air temperature sensor failure	42	ODU
Eb	Tsolar sensor failure	7	IDU
EC	Tbt2 balance water tank bottom Sensor failure	8	IDU
Ed	Twin board replacement water temperature sensor failure	10	IDU
EE	Hydraulic module EEprom failure	11	IDU
P0	Low pressure protection	50	ODU
P1	High pressure/exhaust temperature control switch protection	52	ODU
P3	Compressor overcurrent protection	53	ODU
P4	Tp exhaust temperature overheat protection	54	ODU
P5	Twin-Twout, Twout-Twin or out of the water temperature is too large protection	26	IDU
P6	Module protection (IPDU and IR341, check the specific content)	55	ODU
Pb	Anti-freezing (not a protection, the alarm light does not flash), the remote control does not display Pb, and displays the anti-freezing icon;	25	IDU
Pd	Outdoor unit T3 over temperature protection	57	ODU
PP	Abnormal temperature difference between inlet and outlet water	31	IDU

10 CONTROL



H0	Indoor unit and outdoor unit communication failure (continuous 10 seconds communication abnormality)	3	IDU
H0	Outdoor unit and the indoor unit communication failure (No communication within 10s)	38	ODU
H1	Outdoor unit and IR341 communication failure (outdoor unit and inverter module)	39	ODU
H2	T2 refrigerant gas side temperature sensor failure	12	IDU
H3	T2B refrigerant liquid side temperature sensor failure	13	IDU
H4	3 L (L0/L1) failures in 1 hour report H4, unrecoverable. After H4 failure, the latest 3 L failures can be checked (not limited to L0, L1) For example: report L0-L4-L8-L9-L0-L1 within 1 hour, report H4 failure. Check faults are L9, L0, L1.	44	ODU
H5	Ta temperature sensor failure	15	IDU
H6	DC fan failure	45	ODU
H7	Abnormal supply voltage	46	ODU
H8	High pressure pressure sensor failure (replacement with resistance when the external machine is not installed)	47	ODU
H9	Tw2 sensor fault	20	IDU
HA	Plate exchanger outlet temperature sensor failure	14	IDU
Hb	Three consecutive PP protection and Twout < 7°C fault; power failure recovery;	21	IDU
Hd	Slave and master communication failure (this failure occurs when multiple units are connected in parallel)	24	IDU
HE	Hydraulic module adapter board and hydraulic module communication failure	23	IDU
HF	External unit EEPROM failure	43	ODU
HH	H6 failure 10 consecutive times within 120 minutes (recovery after power off)	48	ODU
HP	Cooling mode low pressure Protection (within 1h, the low pressure is less than 0.6MPa for three consecutive times, can be automatically cleared)	49	ODU
C7	Heat sink over temperature protection	65	ODU
bH	PED small board failure	143	ODU
F1	DC Low bus voltage protection	142	ODU
L0	DC compressor module failure	112	ODU
L1	DC bus low voltage protection	116	ODU
L2	DC bus high voltage protection	134	ODU
L4	MC failure/synchronization/closed loop	135	ODU
L5	Zero speed protection	136	ODU
L7	Phase sequence error protection	138	ODU
L8	Previous and next time speed change > 15Hz protection	139	ODU
L9	Set speed and running speed difference > 15Hz protection	141	ODU



Password-protected unit parameters (installer use)

The unit is set by the factory with default unit parameters to values that can satisfy the greater number of installation cases.

For a detailed customization of the system is however possible to make changes; the following is a list of all unit parameters, with all the available settings.

According to the unit configuration some parameters are visible and some not.

ATTENTION

The access to parameters or modifications are allowed only to the qualified serviceman who assumes all responsibility, in case of doubts please contact Clivet.

For any changes not permitted or not approved by Clivet, the same declines any responsibility for malfunctions and/or damages to the unit/system and to people.

Register address	Signification	Description
200	Type	<p>The high 8 bits is the type of home appliances: Central heating: 0x07 Bit 4 is the product algebra: 0x0*: Serie E 0x1*: Second generation R32, A series 0x2 *: 2nd generation R32 upgrade, A series (compatible with custom requirements) 0x3*: A-Sphera custom upgrade The lower 4 bits are subtypes: R32 refrigerant frequency conversion water pump model: 0X *2; Complete as 0 x0732 The lower 4 bits are subtypes R32 refrigerant frequency conversion pump model: 0x02</p>
201	T1S cooling set temperature upper limit	The low 8 bits are zone 1 and the high 8 bits for Zone 2 The lower 8 bits are area 1 and the upper 8 bits are area 2
202	T1S cooling set temperature lower limit	The low 8 bits are zone 1 and the high 8 bits for Zone 2 The lower 8 bits are area 1 and the upper 8 bits are area 2
203	T1S heating set temperature upper limit	The low 8 bits are zone 1 and the high 8 bits for Zone 2 The lower 8 bits are area 1 and the upper 8 bits are area 2
204	T1S heating set temperature lower limit	The low 8 bits are zone 1 and the high 8 bits for Zone 2 The lower 8 bits are area 1 and the upper 8 bits are area 2
205	TS set temperature upper limit	Read = real*2 actual value *2
206	TS set temperature lower limit	Read =real*2 actual value *2
207	Hot water setting temperature upper limit	
208	Hot water set temperature lower limit	
209	The operating time of the recirculation pump	Recirculation pump, default operating time 5 minutes, adjustment interval 5 - 120 min, with steps of 1 min



210	Parameter setting 1	BIT15	DHW enable/disable
		BIT14	Support water tank electric heating TBH (read only)
		BIT13	Support sterilization function
		BIT12	DHW pump; 1: support; 0 : not supported
		BIT11	Reserved
		BIT10	DHW pump supports Pipe Disinfect
		BIT9	Cooling enable
		BIT8	T1S cooling high/low temperature setting (read only) zone 1
		BIT7	Heating enable
		BIT6	T1S heating high/low temperature setting (read only)
		BIT5	Support PUMPI pump mute function, 1:support
		BIT4	Support room temperature sensor Ta
		BIT3	Support room thermostat (Room thermostat)
		BIT2	Room thermostat MODE SETTING
		BIT1	Dual Room Thermostat, 0= not supported; 1= support
BIT0	0= space cooling and heating priority, 1= Hot water priority		
210	Parameter setting 2	BIT15	ACS (DHW dual water tank enable) 1:Yes 0:No
		BIT14	Dry contact M1M2 control AHS 1: Yes 0: No
		BIT13	RT-Ta_PCNE (Enable temperature small board)
		BIT12	Tbt2 sensor enable 1: Yes 0: No
		BIT11	Piping length selection 1:>10m 0:<10m
		BIT10	Solar input port 1: CN18 0: CN11
		BIT9	Support solar module 1: Yes 0: No
		BIT8	Input port definition: 0 : remote switch 1 : DHW Heater
		BIT7	Smart grid: 0 : None 1 : Yes
		BIT6	T1B sensor enable 0 : None 1 : Yes
		BIT5	T1S cooling high / low temperature setting zone 2
		BIT4	T1S heating high / low temperature setting zone 2
		BIT3	Dual zone setting is effective
		BIT2	Ta sensor position 1 : IDU 0 : HMI
		BIT1	Tbt sensor enable 1: Yes 0: No
BIT0	IBH/AHS installation position 1 : buffer tank 0: pipeline		
212	dT5_On	A series: Default: 10°C, range: 1~30°C E series: Default: 5°C, range: 2 ~ 10°C, adjustment interval 1°C	
213	dT1S5	Default: 10°C, range: 5-40°C, adjustment interval 1°C	
214	T_Interval_DHW	Default: 5min , range: 5~5min , adjustment interval 1min	
215	T4DHWmax	Default: 43°C, range 35-43°C, adjustment interval 1°C	
216	T4DHWmin	A series: Default: -10°C, range: -25~30°C; E series: Default: -10°C, range: -25-5°C; adjustment interval 1°C	

10 CONTROL



217	t_TBH_delay	Default: 30min range: 0~240min ; adjustment interval 5min
218	dT5S_TBH_off	Default: 5°C, range: 0 ~ 10°C, adjustment interval 1°C
219	T4_TBH_on	A series: Default: 5°C, range: -5 ~ 50°C; E series: Default: 5°C, range: -5~20°C; adjustment interval 1°C
220	T5s_DI	Sterilization function water tank set temperature, setting range 60~70°C, default 65 °C
222	t_DI_hightemp	Sterilization high temperature time, setting range: 5~ 60 min , default 15min
223	t_interval_C	Cooling mode compressor start time interval; range: 5~5min , default value is 5min
224	dT1SC	Default: 5°C, range: 2-10°C, adjustment interval 1°C
225	dTSC	Default: 2°C, range: 1-10°C, adjustment interval 1°C
226	T4cmax	Default: 52°C, range: 35-52°C; adjustment interval 1°C
227	T4cmin	Default: 10°C, range: -5-25°C; adjustment interval 1°C
228	t_interval_H	Heating mode compressor start time interval; range: 5~60min, default is 5 min
229	dT1SH	A series: Default: 5°C, range: 2- 20°C; E series: Default: 5°C, range: 2-10°C; adjustment interval 1°C
230	dTSH	Default: 2°C, range: 1-10°C, adjustment interval 1°C
231	T4hmax	Default: 25°C, range: 20-35°C, adjustment interval 1°C
232	T4hmin	A series: Default: -1.5°C, range: -25-30°C, adjusted spacing . 1°C E Series: Default: -1.5°C, range: -25-15°C, adjusted spacing . 1°C
233	T4_IBH_on	The ambient temperature of the electric auxiliary heating IBH of the hydraulic module is turned on, the setting range: -15~10°C, the default value: -5°C
234	dT1_IBH_on	Hydraulic module electric auxiliary heating IBH opening temperature hysteresis, setting range: 2~10°C the default value is 5°C
235	t_IBH_delay	Hydraulic module electric auxiliary heating IBH delay opening time, setting range: 15~120min , default value 30min
236	t_IBH12_delay	RESERVED
237	T4_AHS_on	The external heat source AHS turns on the ambient temperature, A series: Range -15 ~ 30°C, E series: setting range -15 ~ 10°C, Clivet model default value is 10°C, Midea model -5°C
238	dT1_AHS_on	The external heat source AHS turns on the temperature difference, A series: Range: 2 ~ 20°C, the default value . 5°C E series: Setting range: 2~10°C, the default value is 5°
239	dT1_AHS_off	RESERVED
240	t_AHS_delay	The time that the compressor has run before starting the additional heating source, setting range 5~120min, default value 30min
241	t_DHWHP_max	The maximum time for the heat pump to run hot water, the setting range: 10~600min ; default value: 120min; setting value is minute
242	t_DHWHP_restrict	Maximum operating time of the heat pump in heating/cooling mode. The setting range is: 10~600min; the default value is 30min; the setting value is minute.



243	T4autocmin	The default value is: 25°C, the range is: 20~29°C, the adjustment interval is 1°C.
244	T4autohmax	The default value is: 17°C, the range is: 10~17°C, the adjustment interval is 1°C.
245	T1S_HA_H	T1 set value in heating mode during vacation, range: 20~25°C, default 25°C
246	T5S_HA_DHW	T5 set value in hot water mode during vacation, range: 20~25°C, default 25 °C
247	Start percentage	The range is 10-100 , the default is 10. The adjustment interval is 10
248	Adjustment time	Range 1-60 default 5
249	dTbt2	Range 0-50 default 15
250	IBH1 power	Range 0-200 , default 0 , unit 100W
251	IBH2 power	Range 0-200 , default 0 , unit 100W
252	TBH power	Range 0-200 , default 0 , unit 100W
253	Comfort parameter	Reserved, query the register and report address error
254	Comfort parameter	Reserved, query the register and report address error
255	t_DRYUP	Heating days, setting range: 4~15 days, default 8 days
256	t_HIGHPEAK	Drying days, setting range: 3~7 days, default 5 days
257	t_DRYD	Cooling days, setting range: 4~15 days, default 5 days
258	T_DRYPEAK	Maximum drying temperature, setting range: 30-55°C, default 45°C
259	t_firstFH	Floor heating first run time, default value 72hrs, setting range: 48-96hrs
260	T1S(First warm)	Target outlet water temperature in preheating for floor mode: setting range: 25~35°C, default: 25°C;
261	T1SetC1	Cooling temperature curve 9 parameters, setting range 5-25°C, default 10°C
262	T1SetC2	Cooling temperature curve 9 parameters, setting range 5-25°C, default 16°C
263	T4C1	Cooling temperature curve 9 parameters, setting range (-5)-46°C, default 35°C
264	T4C2	Cooling temperature curve 9 parameters, setting range (-5)-46°C, default 25°C
265	T1SetH1	Heating temperature curve 9 parameters, setting range 25-60°C, default 35°C
266	T1SetH1	Heating temperature curve 9 parameters, setting range 25-60°C, default 28°C
267	T4H1	Heating temperature curve 9 parameters, setting range (-25)-35°C, default -5°C
268	T4H2	Heating temperature curve 9 parameters, setting range (-25)-35°C, default 7°C
269		Current limiting scheme, 0= No setting; 1~8= Scheme 1~8, default 0
270	HB: t_T4_FRESH_C	Range 0.5-6hour , adjustment interval 0.5 , sending value = actual value *2
	LB: t_T4_FRESH_H	Range 0.5-6hour , adjustment interval 0.5 , sending value = actual value *2
271	T_PUMPI_DELAY	Range 2-20 , adjustment interval 0.5 , sending value = actual value *2
272	EMISSION TYPE	Bit12-15 : Zone 2 cooling terminal type
		Bit8-11 : Zone 1 cooling terminal type
		Bit4-7 : Zone 2 heating terminal type
		Bit0-3 : Zone 1 heating terminal type



Safety

Operate in compliance with safety regulations in force .

Use single protection devices:

gloves, glasses, helmet, etc..

General

Maintenance must be performed by authorized centres or by qualified personnel

The maintenance allows to:

- maintaining the unit efficient
- reduce the deterioration speed all the equipment is subject to over time
- collect information and data to understand the efficiency state of the unit and prevent possible faults

WARNING

- ⇒ *Before checking, please verify the following:*
- ⇒ *the electrical power supply line should be isolated at the beginning*
- ⇒ *the line isolator device is open, locked and equipped with the suitable warning sign*
- ⇒ *make sure no tension is present*
- ⇒ *After switching the power off, wait at least 5 minutes before accessing to the electrical panel or any other electrical component.*
- ⇒ *Before accessing check with a multimeter that there are no residual stresses.*

Frequency of interventions

Perform an inspection every 6 months.

However, frequency depends on the type of use.

Pan inspections at close intervals in the event of:

- frequent use (continuous or very intermittent use, near the operating limits, etc)
- critical use (service necessary)

WARNING

- ⇒ *Before performing any work, please read carefully: SAFETY WARNINGS FOR OPERATIONS ON UNITS CONTAINING R32*

Boiler maintenance (if present)

- ⇒ *Boiler maintenance (if present)*





SAFETY WARNINGS FOR OPERATIONS ON UNITS CONTAINING R32

Area checks

Before working on systems containing flammable refrigerants, perform safety checks to reduce the risk of combustion to the minimum. Before performing any reparation operations on the cooling system, comply with the following warnings.

Work procedures

Operations must be performed following a controlled procedure so as to reduce the risk of flammable gases or vapours developing.

General work area

All the personnel in charge with maintenance operations and other operators working in the local area must be instructed and monitored as regards the nature of the intervention.

Avoid working in tight spaces. The area surrounding the working space must be cordoned off. Make sure the area is secured by monitoring the flammable material.

Check the presence of refrigerant

Both before and during operations, the area must be monitored with a dedicated refrigerant detector to make sure the technician is aware of the presence of potentially-flammable environments.

Make sure the leak detection equipment is suitable for use with flammable refrigerants and therefore without sparks, suitably sealed or intrinsically safe.

Presence of the fire extinguisher

If hot interventions are not performed on cooling equipment or connected components, suitable fire fighting equipment must be kept at hand.

Keep a dry-powder or CO2 extinguisher near the loading area.

No ignition source

It is absolutely forbidden to use ignition sources that may lead to fire or explosion during operations on the cooling system or on pipes that contain or have contained flammable refrigerant.

All possible ignition sources, including cigarettes, must be kept sufficiently away from the installation, reparation, removal and disposal site as flammable refrigerant may be released in the surrounding area.

Before starting operations, the area surrounding the equipment must be inspected to guarantee the absence of flammables or combustion risks. "SMOKING IS FORBIDDEN" signs must be affixed.

Ventilated area

Before intervening on the system or performing any hot intervention, make sure to be in an outdoor or suitably ventilated area.

Ventilation must be maintained during operations. Ventilation must disperse the released refrigerant safely, preferably outdoors in the atmosphere.

Cooling equipment checks

Should a replacement be necessary, the new components installed must be suitable for the purpose envisaged and compliant with specifications.

Always follow the manufacturer guidelines on maintenance and assistance. In case of doubt, contact the manufacturer technical office for assistance.

The following checks must be performed on systems containing flammable refrigerants:

- the quantity of the charge must comply with the size of the room where the parts containing refrigerant are installed;
- the machine and ventilation intake function correctly and are not obstructed;
- If an indirect cooling circuit is used, the secondary circuits must be checked to verify the presence of refrigerants; the marking on the equipment remains visible and readable;
- Make sure markings and symbols are always readable; cooling pipes or components must be installed in a position that makes improbable their exposure to substances that may corrode the components



containing refrigerant, unless they are manufactured with material intrinsically resistant to corrosion or suitably protected against corrosion.

Electrical device checks

The reparation and maintenance of electric components must include initial safety checks and component inspection procedures.

In case of a fault that compromises safety, do not perform any electrical connection to the circuit until said fault is suitably resolved.

If it is not possible to repair the fault immediately and electrical components need to remain functioning, a temporary solution must be adopted. This must be reported to the owner of the equipment so as to keep all parties informed.

Initial safety checks must include:

- that condensers are emptied. This operation must be performed safely to avoid any sparks;
- that electrical components and wiring are not exposed during the charging, recovering or venting phases;
- That the earth conductor is continuous.

Repairing sealed components

- During the reparation operations of sealed components, disconnect all the equipment before removing sealed casings etc. If, during operations, it is absolutely necessary for the equipment to remain connected, a leak detection device must be placed in the most critical point so as to report any potentially-dangerous situation.
- Pay particular attention to what follows to guarantee that, while intervening on electrical components, the housing is not altered in a way so as to affect the level of protection. This includes damage to cables, an excessive number of connections, terminals not compliance with the original specifications, damage to gaskets, an unsuitable installation of gaskets, etc.
- Make sure the device is installed safely.
- Check that the seals or sealing materials are not altered in such a way that they no longer the impede the entry of flammable environments. Spare parts must comply with manufacturer specifications.

NOTE:

⇒ *Using silicone sealants may inhibit the effectiveness of a few types of leak detection equipment. It is not necessary to isolate intrinsically safe components before performing operations on them.*

Reparation of intrinsically safe components

Do not apply permanent inductive or capacitive loads to the circuit without making sure that they do not exceed the admissible voltage and current allowed for equipment in use.

Intrinsically safe components are the only component type on which operations can be performed in a flammable atmosphere. The testing device must show a correct value. Replace components only with the parts specified by the manufacturer.

Following a leak, other parts could lead to the combustion of the refrigerant in the atmosphere.

Wires

Make sure wires are not subjected to wear, corrosion, excessive pressure or vibration, that there are no sharp edges and that they do not produce other negative effects on the environment. The inspection must also keep into consideration the effects of time or the continuous vibration caused e.g. by compressors or fans.

Detection of flammable refrigerants

Under no circumstance is it possible to use potential ignition sources to search or detect refrigerant leaks.

Do not use halide lights (or any other open flame detectors).

Leak detection methods

The following leak detection methods are considered acceptable for systems containing flammable refrigerants. Electric leak detectors must always be used to identify flammable refrigerants, although they do not present a suitable sensitivity level or require recalibration (detection equipment must be calibrated in an area free from refrigerants).



Check that the detector is not a possible source of ignition and that it is suitable for the refrigerant. Leak detection equipment must always be set to an LFL percentage and calibrated depending on the refrigerant used, so the correct gas percentage (25% max) must be verified.

Leak detection fluids are suitable for most refrigerants, although using detergents containing chlorine should be avoided as this substance may react with the refrigerant and corrode copper pipes.

If a leak is suspected, all open flames must be removed or switched off.

If a leak is identified that requires brazing, all the refrigerant must be recovered from the system or isolated (using interception valves) in a section of the system far away from the leak. Oxygen-Free-Nitrogen (OFN) is then purged through the system both before and during the brazing procedure.

Removal and evacuation

When intervening on the cooling circuit to perform repair work or any other type of work, always follow the normal procedure. However, considering the risk of flammability, we recommend following the best practices. Comply with the following procedure:

- remove the refrigerant;
- purge the circuit with inert gas;
- evacuate;
- Purge again with inert gas;
- Interrupt the circuit with interruption or brazing.

The refrigerant charge must be collected in suitable recovery tanks. To make the unit safe, flushing with Oxygen-free-Nitrogen must be performed. This procedure may have to be repeated multiple times. Do not use compressed air or oxygen for this operation.

Flushing is obtained interrupting the system vacuum with OFN and filling until the operating pressure is obtained, then releasing into the atmosphere and restoring the vacuum. This process must be repeated until there is no trace of refrigerant in the system.

When using the final OFN charge, the system must be vented to the atmospheric pressure to allow the intervention. This step is essential to perform brazing operations on the pipes.

Make sure that the vacuum pump intake is not near ignition sources and that there is suitable ventilation.

Charging operations

In addition to conventional charging operations, the following requirements must be complied with:

- When using charging equipment, make sure that the various refrigerants are not contaminated. Flexible tubes or conduits must be as short as possible to reduce to the minimum the quantity of refrigerant contained.
- Tanks must be kept in a vertical position.
- Before loading the system with refrigerant, check that the cooling system is earthed.
- Label the system when fully charged (unless already labelled).
- Make sure not to fill the cooling system excessively.
- Before recharging the system, the pressure must be tested with OFN. A leak test must be performed after the charging operations but before commissioning. Before leaving the site, perform an additional leak test.

Dismantling

Before performing this procedure, it is essential that the technician has become familiar with the equipment and the relative details.

We recommend employing good practices for a safe recovery of the refrigerants.

Before performing the operation, take a sample of oil and refrigerant should an analysis be necessary before reusing the regenerated refrigerant. Before performing the operation, check the availability of electricity.

- Become familiar with the equipment and how it functions.



- Electrically isolate the system.

Before attempting the procedure, check that:

- The mechanical manipulation equipment is available, if necessary, to handle refrigerant tanks;
- All the personal protection equipment is available and employed correctly;
- The recovery procedure is monitored at all times by skilled personnel;
- The recovery equipment and tanks comply with suitable standards.
- If possible, pump the cooling system.
- If it is not possible to obtain a vacuum, make sure that a collector removes the refrigerant from various parts of the system.
- Before proceeding with the recovery, check that the tank is located on the scales.
- Start up the recovery machine and use it following the instructions by the manufacturer.
- Do not fill the tanks excessively. (Do not exceed 80% of the liquid volume).
- Do not exceed the tank's maximum operating pressure, not even momentarily.
- Once the tanks are filled correctly and the process is over, make sure that the tanks and equipment are immediately removed from the site and that all insulation valves on the equipment are closed.
- The refrigerant recovered must not be loaded into another cooling system unless it has been cleaned and checked.

Labelling

Equipment must be labelled reporting the dismantling and emptying of the refrigerant.

Labels must be dated and signed.

Make sure all the equipment is labelled and reporting the presence of flammable refrigerant.

Recovery

When removing the refrigerant from the system, please adopt good practices to remove all refrigerants safely in case of both assistance or decommissioning operations.

When transferring the refrigerant into the tanks, make sure only suitable tanks are used to recover the refrigerant.

Make sure enough tanks are used.

All the tanks to be used are designated for the recovered refrigerant and are labelled for that specific refrigerant (e.g. special tanks for refrigerant collection).

Tanks must be equipped with a perfectly-functioning safety valve and relative interception valves.

Empty recovery tanks are evacuated and, if possible, cooled before recovery.

Recovery equipment must be perfectly functioning with the respective instruction booklets at hand and they must be suitable to recover flammable refrigerants. A series of perfectly-functioning calibrated scales must also be available.

Flexible tubes must be equipped with leak-proof disconnection fittings in good condition. Before using the recovery machine, make sure it is in good condition, maintained and that all associated electrical components are sealed to avoid combustion in case of a refrigerant leak. Please contact the manufacturer in case of doubt.

The refrigerant recovered must be taken to the supplier in suitable recovery tanks and with the relative waste transfer note suitably filled in.

Do not mix the refrigerants in the recovery units nor in the tanks.

If it is necessary to remove compressors or compressor oils, make sure they are evacuated to an acceptable level to make sure no trace is left of the flammable refrigerant inside the lubricant. The evacuation process must be performed before taking the compressors back to the suppliers.

The electric resistance must be used with the compressor body only to accelerate this process.

Operations to discharge the oil from the system must be performed in full safety.

20. Transport, mark and storage

- 1 Transport of equipment containing flammable refrigerants
Compliance with transport regulations



- 2 Marking of equipment with symbols
Compliance with local regulations
- 3 Disposal of equipment employing flammable refrigerants
Compliance with national regulations
- 4 Storage of equipment/devices
The equipment must be stored in compliance with the instructions provided by the manufacturer.
- 5 Storing packed (unsold) equipment
Packing must be performed in such a way that mechanical damage to the equipment inside it does not cause refrigerant leaks.
The maximum number of elements that can be stored together is determined by local regulations.



Checklist for recommended regular checks

Checks effected on.....by.....of the company.....

√	intervention frequency (months)	1	6	12
<input type="checkbox"/>	Panel fixing			X
<input type="checkbox"/>	External unit fan fixing		X	
<input type="checkbox"/>	External unit coil cleaning		X	
<input type="checkbox"/>	Charged pressure of water system		X	
<input type="checkbox"/>	Docking joints, caps and shafts		X	
<input type="checkbox"/>	Leak visual check on solar panel fittings		X	
<input type="checkbox"/>	Air in the pipes			X
<input type="checkbox"/>	Flow switch / differential pressure switch function			X
<input type="checkbox"/>	Drain dirt separator	X	X	X
<input type="checkbox"/>	Anode check		X	
<input type="checkbox"/>	Capacity contactor status			X
<input type="checkbox"/>	Terminal closing, cable insulation integrity			X
<input type="checkbox"/>	Voltage and phase unbalancing (no load and on-load)		X	
<input type="checkbox"/>	Absorptions of the single electrical loads		X	
<input type="checkbox"/>	Compressor carter residue test		X	
<input type="checkbox"/>	Leak control *			X
<input type="checkbox"/>	Measure of operating parameters of the refrigerant circuit		X	
<input type="checkbox"/>	Check drier filter			X
<input type="checkbox"/>	Presence of oil stains		X	
<input type="checkbox"/>	Closure of pipe unions, Schrader caps		X	
<input type="checkbox"/>	Protective device / integrity test : safety valves, pressure switches, thermostats, flow switches etc		X	
<input type="checkbox"/>	Check schedulers, setpoints, compensations, etc...		X	
<input type="checkbox"/>	Control device/integrity test: alarm signalling, thermometers, probes, pressure gauges etc		X	
<input type="checkbox"/>	Fill in the unit booklet			

NOTE

⇒ Refer to the local regulations. Companies and technicians performing installation, maintenance/repair, leak control and recovery operations must be CERTIFIED as set out by the local regulations.



Unit booklet

It's advisable to create a unit booklet to take notes of the unit interventions.

In this way, it will be easier to adequately schedule the various interventions and facilitate any troubleshooting.

On the schedule note:

- date
- intervention description
- carried out measures etc.

Standby mode

If a long period of inactivity is foreseen:

- turn off the power
- avoid the risk of frost (empty the system or add glycol)

Turn off the power to avoid electrical risks or damages by lightning strikes.

With lower temperatures keep heaters turned on in of the electrical panel (option).

It's recommended that the re-start after the stopping period is performed by a qualified technician, especially after seasonal stops or seasonal

switching.

When restarting, refer to what is indicated in the "start-up" section.

Schedule technical assistance in advance to avoid hitches and to guarantee that the system can be used when required



External unit fan

Check:

- ensure that the fan and the relative protection grids are well fixed
- The fan bearings (evident by noise and anomalous vibrations)
- the terminal protection covers are closed and the cable holders are properly positioned

Access to the fan

- Remove the screws (A)

DANGER

⇒ *Exercise caution to avoid a possible hand injury.*

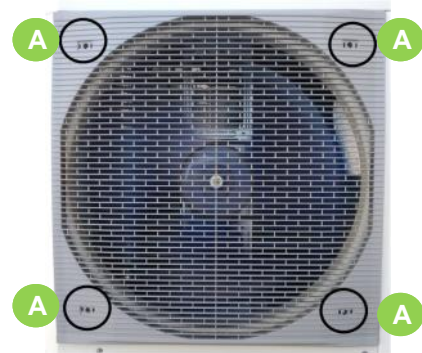



Valve motor assembly / disassembly

Should the motor be disassembled from the valve body, reassemble it following the instructions.

Ensure that the motor is in the "high" position, visible from the lever positioned at the top (DHW)

Place it on the valve body, turn it to lock.

Motion from the lever from "low" to "high" can only be done electrically (set the unit in DHW operation).

The assemble of the motor with the lever in the "low" position (direction the system, standard position) is not admitted, risk of valve breakage.

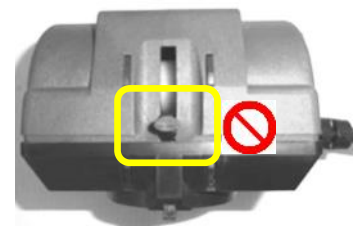
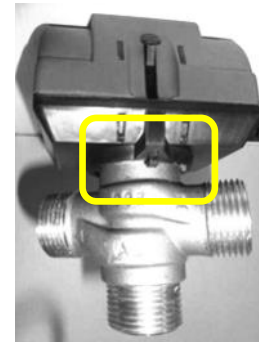
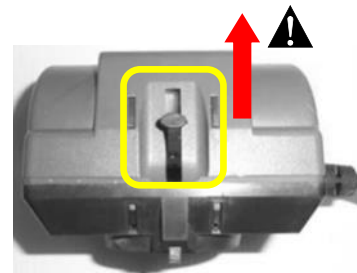



Outdoor unit air coil

Accidental contact with the exchanger flaps can cause injuries from cut: use protective gloves.

The coil must allow maximum thermal exchange, therefore, the surface must be clear from dirt and scaling.

Clean the air inlet side.

Use a soft brush or aspirator or pressurised air jet or high-pressure water jet machine.

Keep the direction parallel to the flow of the flaps to avoid damages.

Check the aluminium flaps have not been damaged or folded, on the contrary contact an authorised after-sales assistance centre to "comb" the coil for excellent air flow.

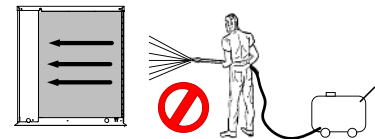
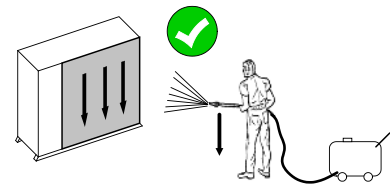

Outdoor unit condensate drain

Dirt or scale can give rise to clogging.

Also, microorganisms and mould can flourish in the bowl.

Foresee periodical cleaning with suitable detergents and, eventually, disinfect with sanitising products.

Once cleaning is completed, pour water inside the bowl to check the regular outflow.

A - Condensate discharge connection

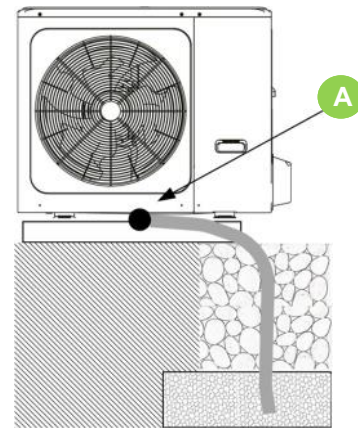

Size 2.1 - 3.1

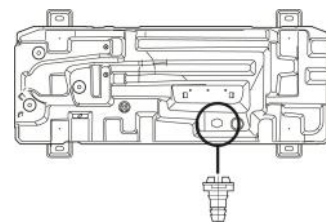

Size 4.1 - 5.1

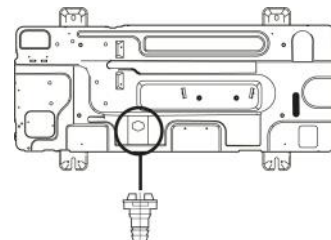



Periodic system checks

- Charge check of expansion tanks
- Water filter cleaning check
- Check system and aqueduct operating pressures

Expansion vessel

Check the expansion vessel charge (at least once a year).

First check that the expansion vessel is totally drained of water. If you necessary load with nitrogen, take care that the pressure does not exceed the value indicated on the label.

Water filter

Check that no impurities prevent the correct passage of water.

Safety valves

The safety valves must be checked regularly.

Almost all losses are caused by impurities deposited inside the valve.

It's normal if some water drops from the hole of safety valve during operation.

But, if there is a great amount of water, call your service agent for instructions.

Please beware of burn, beware of the hot water from the valve.

To carry out a wash:

- manually open the valve
- rotate the knob in the sense indicated by the arrow in the knob.

A. DHW safety valve (6 bar)

B. System safety valve (3 bar)

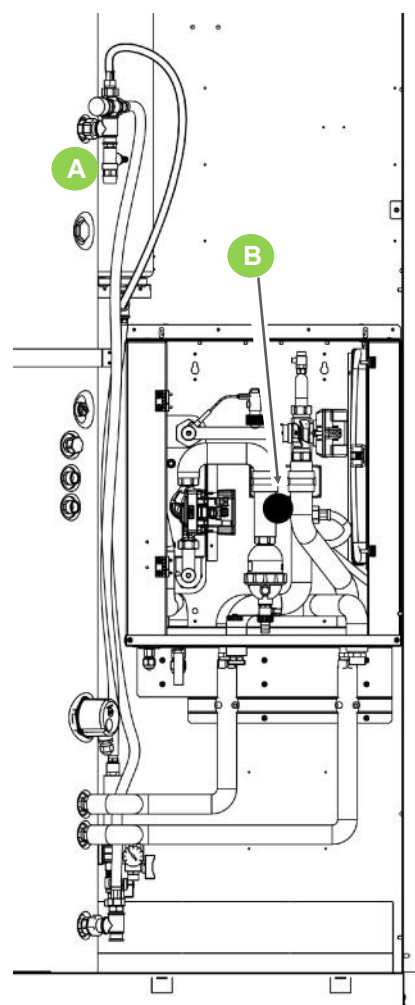
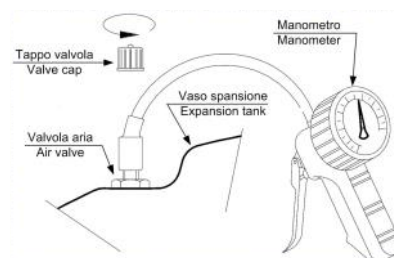



Sacrificial anode

The magnesium sacrificial anodes assure the storage tank anti-corrosive protection.

Check the anode:

- 1 Remove power supply
- 2 Close tap (A) water inlet
- 3 Open hot water tap, and decrease the pressure of the inner storage tank.
- 4 Connect a pipe to the tap (B) and place in an area suitable for discharge or an collection tank.
- 5 Open tap (B)
- 6 Empty the storage up to point (C)
- 7 Unscrew the cap
- 8 Take off the anode rod.

Danger

⇒ Beware of your body for burns.

⇒ The outlet water temperature maybe very high when emptying

Note

Check the wear state, replace if $\varnothing < 10$ to 15 mm.

The anode must be:

- Checked all 6 -12 months
- Replaced all 2 - 3 years

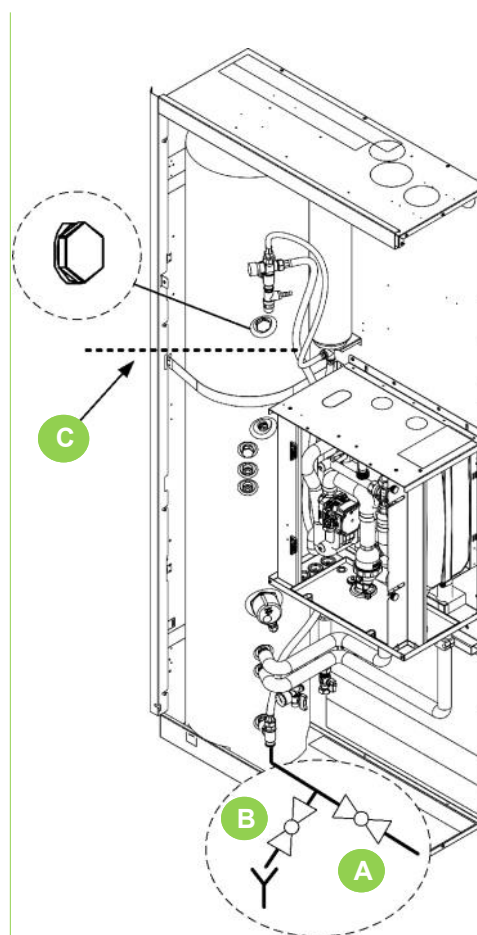

Limestone deposit of discharge DHW storage tank

- 1 Turn the system's main switch to "off"
- 2 Close tap (A) water inlet
- 3 Connect a pipe to the tap (B) and place in an area suitable for discharge or an collection tank.
- 4 Open tap (B)
- 5 Download any deposits on the bottom
- 6 Close tap (B)
- 7 Open tap (A)

Danger

⇒ Beware of your body for burns.

⇒ The outlet water temperature maybe very high when emptying

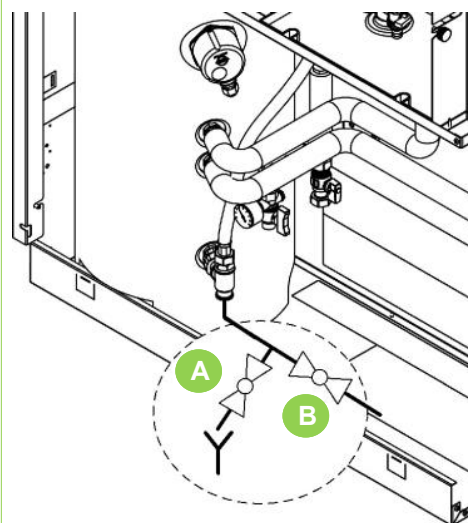



Magnetic sludge

Magnetic filter “A” separates the impurities (sand particles, rust ... etc) present in the system water.

NOTE

⇒ *Open the safety valve (B) to release the system pressure.*

The impurities are collected in a settling chamber.
Cleaning the filter can also be done with a working system.
Clean the filter:

- During the start up of the unit
- After one week from the start up
- After one month from start up
- Once a year

Unloading

- Remove the magnet holder cartridge (1);
- Open the tap to purge impurities (2);
- Close the tap.

Cleaning (extraordinary)

Close the shut-off valves of the system and water supply.
Disassembly sequence:

- Unscrew the ring nut (1) of the lower cover (2) of the dirt separator and remove the filter
- Take out the magnet cartridge.
- Clean the filter and the bottom cover.
- Reinsert the magnet cartridge.
- Close the bottom cover of the dirt separator
- Open the shut-off valves of the plant and aqueduct.

Check pressure of the plant

Structure

Check the condition of the parts making up the structure.
Paint so as to eliminate or reduce oxidation at the points in the unit where this problem may occur.
Check that the panelling is fastened correctly.
Poor fastening may give rise to malfunctions and abnormal noise and vibration.

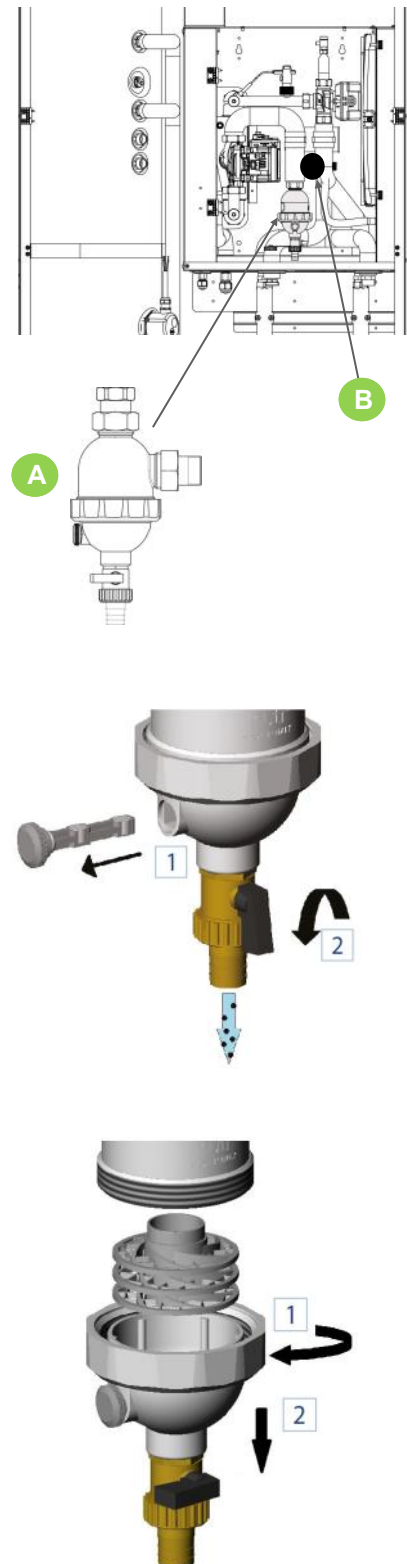



Disconnection

WARNING

⇒ Before performing any operation, read the warnings found in the Maintenance chapter.

Avoid leak or spills into the environment.

Before disconnecting the unit, the following must be recovered, if present:

- refrigerant gas
- Anti-freeze solutions in the hydraulic circuit

Awaiting decommissioning and disposal, the unit can also be stored outdoors, as bad weather and rapid changes in temperature do not harm the environment provided that the electric, cooling and hydraulic circuits of the unit are intact and closed.

WEEE INFORMATION

The manufacturer is registered on the EEE National Register, in compliance with implementation of Directive 2012/19/EU and relevant national regulations on waste electrical and electronic equipment.

This Directive requires electrical and electronic equipment to be disposed of properly.

Equipment bearing the crossed-out wheelie bin mark must be disposed of separately at the end of its life cycle to prevent damage to human health and to the environment.

Electrical and electronic equipment must be disposed of together with all of its parts.

To dispose of “household” electrical and electronic equipment, the manufacturer recommends you contact an authorised dealer or an authorised ecological area.

“Professional” electrical and electronic equipment must be disposed of by authorised personnel through established waste disposal authorities around the country.

In this regard, here is the definition of household WEEE and professional WEEE:

WEEE from private households: WEEE originating from private households and WEEE which comes from commercial, industrial, institutional and other sources which, because of its nature and quantity, is similar to that from private households. Subject to the nature and quantity, where the waste from EEE was likely to have been by both a private household and users of other than private households, it will be classed as private household WEEE;

Professional WEEE: all WEEE which comes from users other than private households.

This equipment may contain:

refrigerant gas, the entire contents of which must be recovered in suitable containers by specialised personnel with the necessary qualifications;

- lubrication oil contained in compressors and in the cooling circuit to be collected;
- mixtures with antifreeze in the water circuit, the contents of which are to be collected;
- mechanical and electrical parts to be separated and disposed of as authorised.

When machine components to be replaced for maintenance purposes are removed or when the entire unit reaches the end of its life and needs to be removed from the installation, waste should be separated by its nature and disposed of by authorised personnel at existing collection centres.



Warning:
Fire hazard
Flammable materials



13 TECHNICAL INFORMATION

Dimensional Recessed cabinet

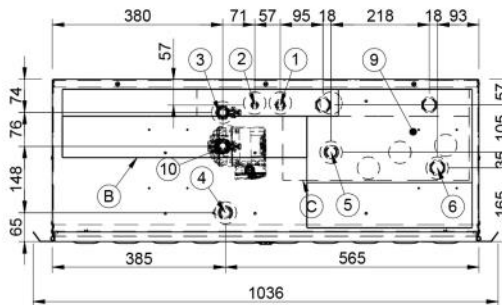
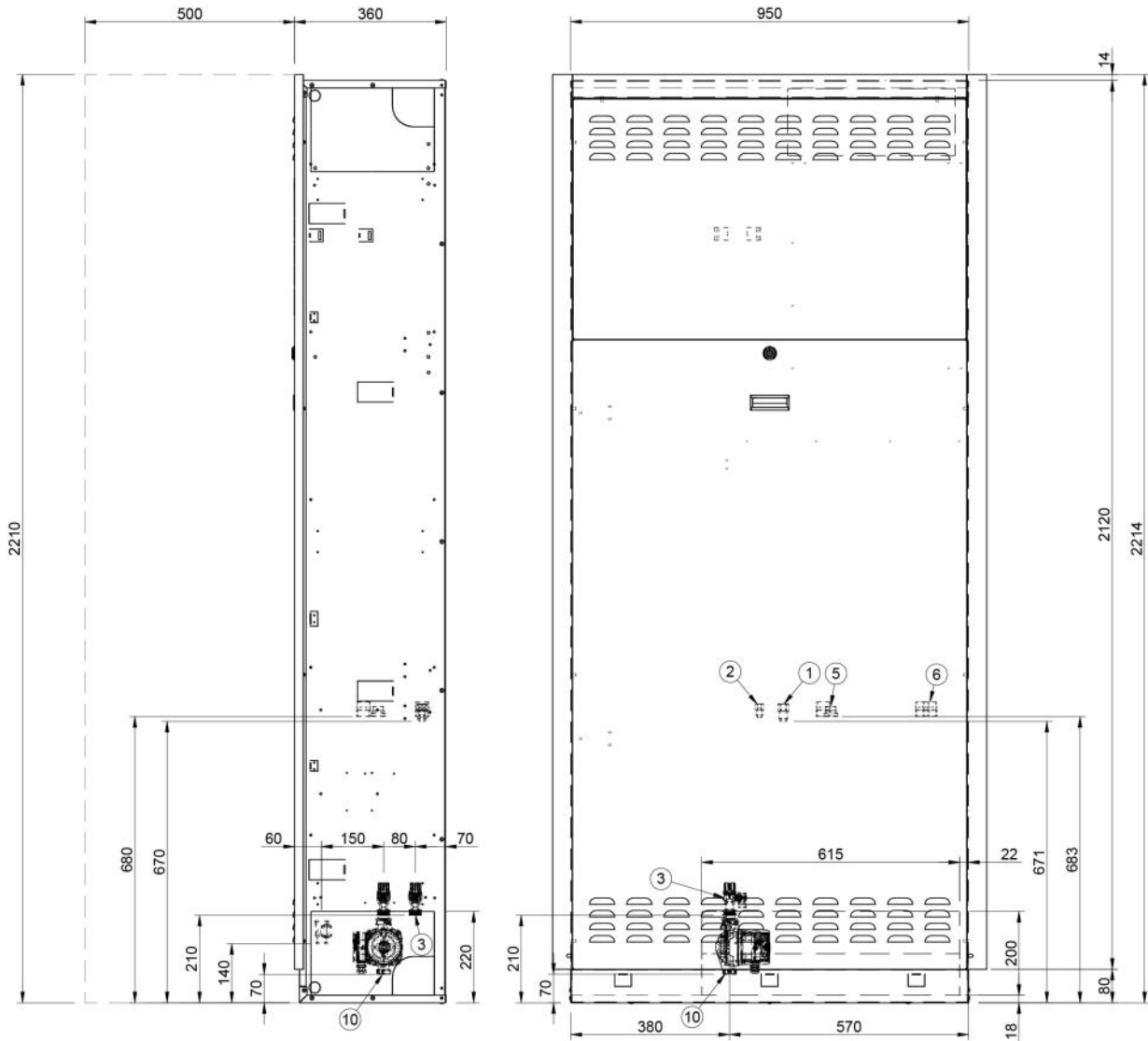

	Description
1	Gas fittings 5/8"
2	Liquid fitting 3/8"
3	Domestic hot water supply M 3/4"
4	Aqueduct inlet M 3/4"
5	Supply to system M 1"
6	Return from system M 1"
9	Condensate drain and valve
10	Domestic water recirculation pump M 3/4" G (option)
A	Flaps for wall fastening
B	Pre-drilled areas for pipes
C	Pre-drilled parts for exhaust pipe (only Hybrid)
*	Functional spaces

Unit	Shipping weight [kg]	Operating weight [kg]
Hydrobox	53	45
Recessed storage STD	70	65
Recessed storage STD+ connection kit	55	205
Hydrobox + Recessed storage STD+ connection kit		315

External unit Size 2.1 - 3.1

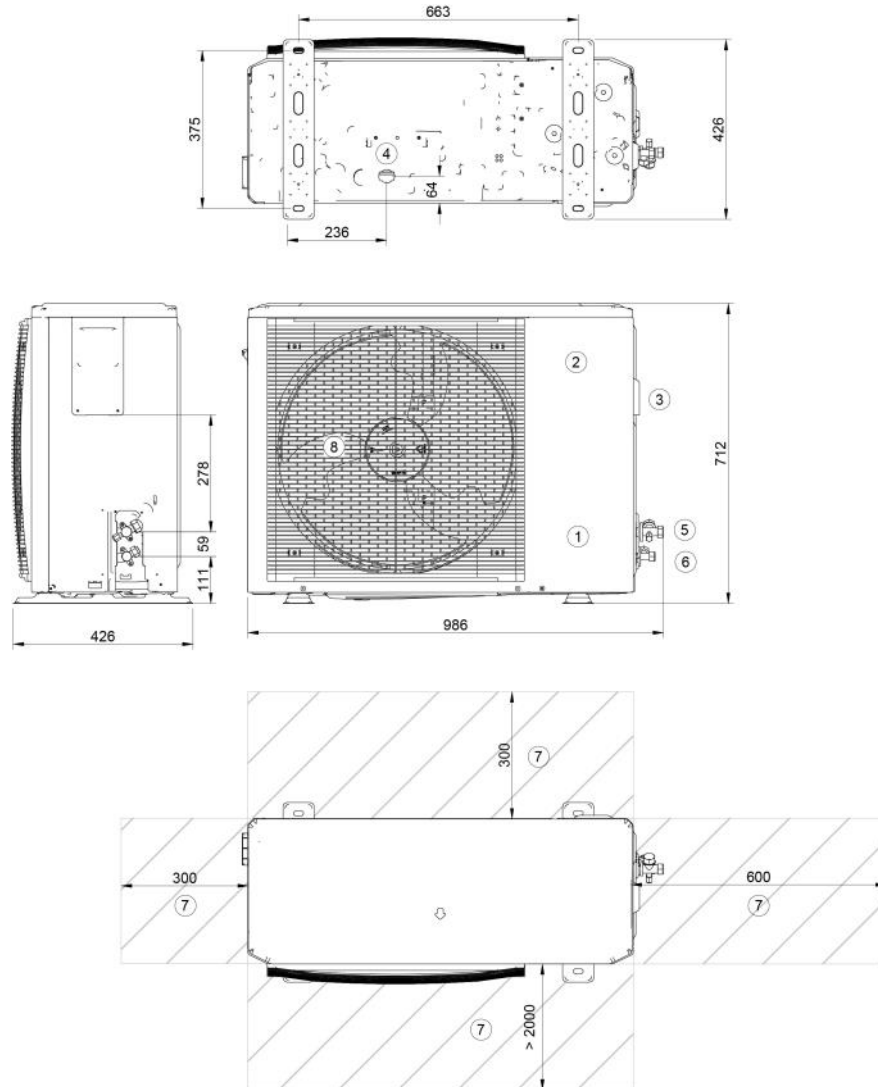

- 1 Compressor compartment
- 2 Electrical panel
- 3 Power input
- 4 Condensate drain
- 5 Suction line connection (ø 1/4" G)
- 6 Liquid line connection (ø 5/8" G)
- 7 Functional spaces
- 8 Electric fan

(M) Air supply

Size		2.1 -3.1
Operating weight	kg	57
Shipping weight	kg	60

13 TECHNICAL INFORMATION

Size 4.1 - 5.1

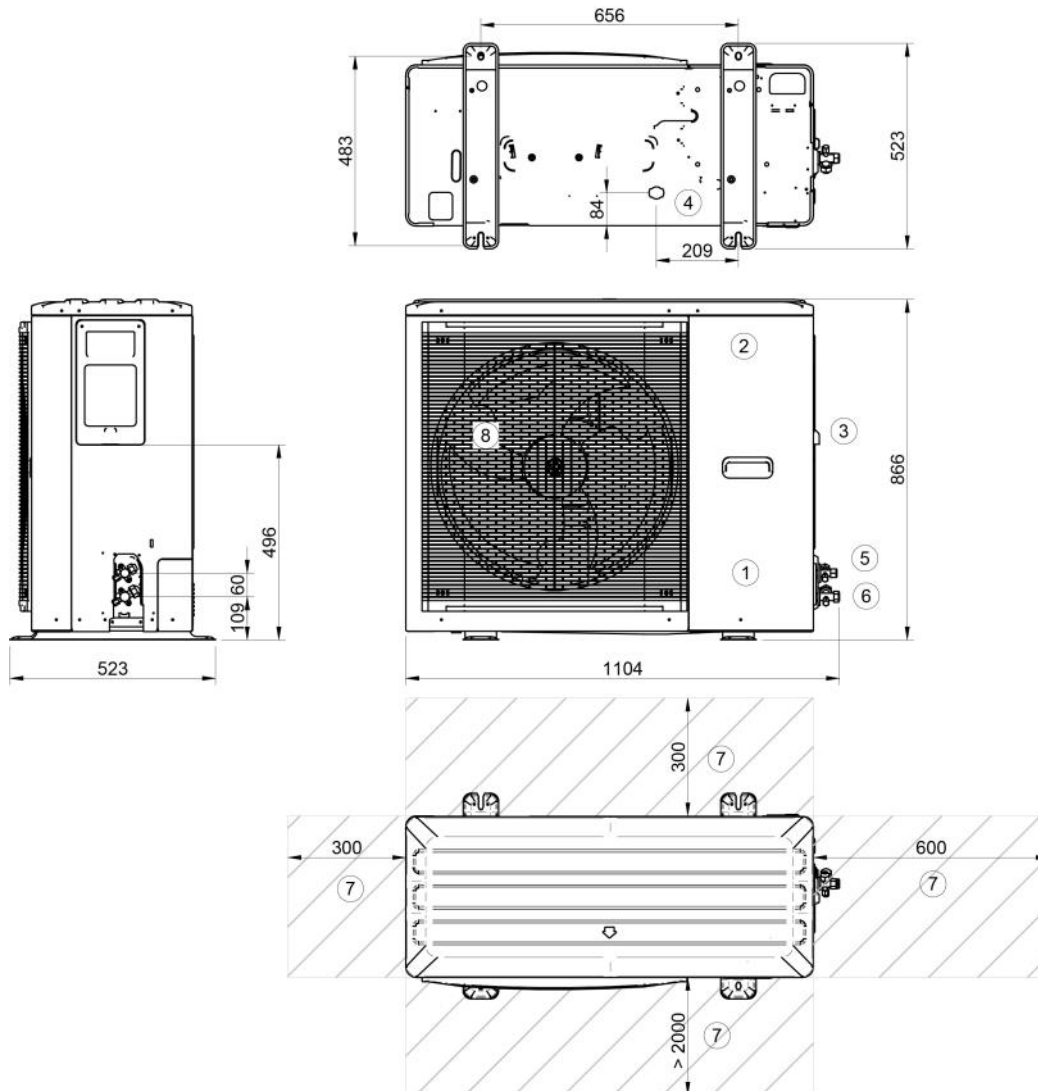

- 1 Compressor compartment
- 2 Electrical panel
- 3 Power input
- 4 Condensate drain
- 5 Suction line connection (ø3/8" G)
- 6 Liquid line connection (ø5/8" G)
- 7 Functional spaces
- 8 Electric fan

(M) Air supply

Size		4.1 - 5.1
Operating weight	kg	77
Shipping weight	kg	88

General technical data

Size			2.1	3.1	4.1	5.1
Storage tank capacity			150L	150L	150L	150L
Heating						
Air 7°C - Water 35°C						
Nominal Heating capacity/Max	1	kW	4,32/6,26	6,18/7,41	8,30/9,11	10,09/10,3
Total power input	1	kW	0,80	1,19	1,56	2,01
COP	1	-	5,42	5,21	5,31	5,01
Water flow-rate	1	l/s	0,21	0,30	0,41	0,49
Nominal available pressure	1	kPa	31,2	36,5	33,1	31,0
Maximum available pressure	1	kPa	69	62	47	31
Air 7°C - Water 35°C						
Nominal Heating capacity/Max	2	kW	4,17/6,25	6,05/6,97	7,33/8,35	8,20/9,30
Total power input	2	kW	1,32	2,01	2,27	2,67
COP	2	-	3,16	3,00	3,23	3,07
Water flow-rate	2	l/s	0,22	0,29	0,34	0,40
Nominal available pressure	2	kPa	35,0	39,8	34,0	31,7
Maximum available pressure	2	kPa	69	64	58	49
Air 7°C - Water 45°C						
Nominal Heating capacity/Max	3	kW	4,16/5,96	6,03/7,13	8,22/8,98	10,01/10,30
Total power input	3	kW	1,06	1,57	2,08	2,59
COP	3	-	3,93	3,83	3,95	3,86
Water flow-rate	3	l/s	0,19	0,30	0,39	0,49
Nominal available pressure	3	kPa	32,3	36,4	34,9	31,0
Maximum available pressure	3	kPa	70	63	51	31
Air 7°C - Water 55°C						
Nominal Heating capacity/Max	4	kW	4,08/5,74	5,94/6,90	7,50/7,80	9,60/9,72
Total power input	4	kW	1,36	1,93	2,35	3,10
COP	4	-	3,00	3,07	3,19	3,10
Water flow-rate	4	l/s	0,12	0,18	0,23	0,29
Nominal available pressure	4	kPa	35,6	33,4	31,2	33,6
Maximum available pressure	4	kPa	70	70	69	63
Cooling						
Air 35°C - Water 18°C						
Nominal Cooling capacity/Max	5	kW	4,55/6,88	6,44/7,65	8,10/11,13	10,00/12,03
Total power input	5	kW	0,75	1,23	1,58	2,10
EER	5	-	6,08	5,24	5,12	4,77
Water flow-rate	5	l/s	0,22	0,32	0,38	0,48
Nominal available pressure	5	kPa	34,9	34,8	34,6	10,6
Maximum available pressure	5	kPa	69	61	51	32
Air 35°C - Water 7°C						
Nominal Cooling capacity/Max	6	kW	4,26/6,14	6,25/6,39	7,46/7,94	8,67/9,10
Total power input	6	kW	1,22	2,02	2,24	2,94
EER	6	-	3,50	3,09	3,33	3,09
Water flow-rate	6	l/s	0,20	0,29	0,36	0,43
Nominal available pressure	6	kPa	35,8	36,1	34,3	36,8
Maximum available pressure	6	kPa	70	64	56	43

13 TECHNICAL INFORMATION

- 1 User side entering/leaving water temperature 30/35 °C, source side air 7°C (U.R. = 85% Heat power data, Total power input and COP in accordance with EN 14511:2018
 - 2 User side entering/leaving water temperature 30/35 °C, source side air -7°C Heat power data, Total power input and COP in accordance with EN 14511:2018
 - 3 User side entering/leaving water temperature 40/45 °C, source side air 7°C (U.R. = 85% Heat power data, Total power input and COP in accordance with EN 14511:2018
 - 4 User side entering/leaving water temperature 18/23 °C, source side air 35°C Heat power data, Total power input and COP in accordance with EN 14511:2018
 - 5 User side entering/leaving water temperature 7/12 °C, source side air 35°C Heat power data, Total power input and COP in accordance with EN 14511:2018
 - 6 The product is conforming with the European ErP Directives, which includes Commission Delegated Regulation (EU) N. 811/2018 and Commission Delegated Regulation N. 813/2018, Clima Average, High Temperature 47/55°C
- * All data calculated with zero height difference and equivalent length of 7m.

SIZE			2.1	3.1	4.1	5.1
Storage tank capacity			150L	150L	150L	150L
ErP						
Average climate conditions - Heat pumps for High temperature applications						
Rated power	7	kW	4	6	7	9
SCOP	7	-	3.32	3.54	3.72	3.73
Generator energy class	7	-	A++	A++	A++	A++
η_s	7	%	130	138	146	146
System Energy Class	7	-	A++	A++	A++	A++
η_s	7	%	135	143	151	151
Average climate conditions - Heat pumps for Low temperature applications						
Rated power	8	kW	5	6	8	10
SCOP	8	-	5,13	5,15	5.32	5.27
Generator energy class	8	-	A+++	A+++	A+++	A+++
η_s	8	%	202	203	210	208
System Energy Class	8	-	A+++	A+++	A+++	A+++
η_s	8	%	207	208	215	213
Average climate conditions - Heat pump for fan coil applications						
Rated power	9	kW	4	6	7	9
SEER	9	-	5,09	5,42	5.95	6.01
Generator energy class	9	-	A+++	A+++	A+++	A+++
η_s	9	%	201	214	235	238
Heat pump for domestic hot water applications						
Declared load profile	10	-	L	L	L	L
η_{wh}	10	%	120	120	116	116
Domestic water energy class	10	-	A+	A+	A+	A+

- 7 The product is conforming with the European ErP Directives, which includes Commission Delegated Regulation (EU) N. 811/2018 and Commission Delegated Regulation N. 813/2018, Clima Average, High Temperature 47/55°C
- 8 The product is conforming with the European ErP Directives, which includes Commission Delegated Regulation (EU) N. 811/2018 and Commission Delegated Regulation N. 813/2018, Clima Average, Low Temperature 30/35°C
- 9 The product is conforming with the European ErP Directives, which includes Commission Delegated Regulation (EU) N. 811/2018 and Commission Delegated Regulation N. 813/2018, Clima Average, Clima Average, Low temperature 12/7°C
- 10 Data in accordance: EN 16147:2017

* All data calculated with zero height difference and equivalent length of 7m.

Construction - Outdoor unit

Size			2.1	3.1	4.1	5.1
Characteristics						
Compressor			Twin Rotary			
Refrigerant			R32	R32	R32	R32
Refrigerant charge		kg	1.50	1.50	1.65	1.65
GWP		t _{CO2}	675	675	675	675
Equivalent tons of CO ₂ (*)		t _e	1.02	1.02	1.11	1.11
Oil charge		l	0,46	0,46	0,46	0,46
Type of fan			Axial fan			
Nominal air flow		m ³ /h	2770	2770	4030	4030
Outdoors unit sound pressure at 1 metre	1	dB(A)	42	44	45	47
Sound power	1	dB(A)	55	57	58	60
Dimensions						
Operating (L x P x A)		mm	986x426x712	986x426x712	1140x523x866	1140x523x866
Package (L x P x A)		mm	1065x485x800	1065x485x800	1180x560x890	1180x560x890
Operation weight		kg	58	58	77	77
Shipping weight		kg	64	64	88	88

1 Sound pressure level determined using the intense metric method (UNI EN ISO 9614-2). Data referred to the following full load conditions:
 Heating - utility side water inlet/outlet 47/55°C, air source side 7°C. Cooling - utility side water inlet/outlet 12/7°C, air source side 35°C.
 (*) It contains fluorinated greenhouse gases.

Construction - Indoor unit

Size				A
System characteristics				
Maximum circuit pressure		bar	3,0	
System expansion tank	1	l	8,0	
Expansion vessel pre-charge		bar	1,0	
System water connections		inch	1"	
Sanitary characteristics				
Tank type			Steel INOX AISI 316 L	
Domestic hot water tank volume		l	150	
Internal coil exchange surface		m ²	1,0	
Storage dispersion		W/K (kWh/24h)	1.69 (1.82)	
Sanitary safety electric heater		kW	2,0	
Maximum sanitary circuit pressure		bar	6,0	
Recommended sanitary expansion vessel		l	8,0	
Sanitary water connections		inch	3/4"	
Dimensions				
Operating (L x P x A)		mm	950 x 360 x 2200	
Package (L x P x A)		mm	2300 x 430 x 1225	
Operation weight		kg	317	
Shipping weight		kg	180	

1 Sufficient volume up to a maximum of 70 litres of system water content.

Hydraulic data - Indoor unit + Outdoor unit

Size			2.1	3.1	4.1	5.1
Characteristics			A	A	A	A
Minimum system water content	1	l	40	40	40	40
Minimum admitted water flow rate		l/s	0,16	0,16	0,16	0,16
Maximum admitted water flow rate		l/s	0,61	0,61	0,61	0,61
Net boiler capacity		l	143	143	143	143
DHW tank setpoint		°C	50	50	50	50
Water mixed at 40°C (V40)		l	188	188	188	188
Warm-up time	2	h:min	02:11	02:11	01:47	01:47
Energy consumption during heating	3	kWh	1,90	1,90	2,00	2,00

1 Consider the water content of the area with less volume

2 Time required to bring the water volume of the tank from a temperature of 10°C to a temperature of 50°C

3 Energy consumption to bring the water volume of the tank from a temperature of 10°C to a temperature of 50°C

Sound levels outdoor unit

Standard mode

SIZE	Sound power level								Sound pressure level	Sound power level
	Octave band (Hz)									
	63	125	250	500	1000	2000	4000	8000	dB(A)	dB(A)
2.1	46	49	49	52	52	46	37	27	42	55
3.1	49	48	50	55	53	48	39	30	44	57
4.1	36	51	53	56	55	49	44	30	45	58
5.1	37	56	53	57	57	51	47	36	47	60

Sound levels refer to units with full load under nominal test conditions. Data referred to the following conditions: entering / leaving exchanger water temperature user side 47/55°C source side exchanger air inlet 7°C.

The sound pressure level refers to a distance of 1m from the external surface of the units operating in an open field.

Noise levels are determined using the tensiometric method (UNI EN ISO 9614-2).

Silenced mode

SIZE	Sound pressure level	Sound power level
	dB(A)	dB(A)
2.1	40	53
3.1	40	53
4.1	42	55
5.1	42	55

Sound levels refer to units with full load under nominal test conditions. For maximum capacity delivered in silent mode use a correction factor of 0.8.

Data referred to the following conditions: entering / leaving exchanger water temperature user side 47/55°C source side exchanger air inlet 7°C.

The sound pressure level refers to a distance of 1m from the external surface of the units operating in an open field.

Noise levels are determined using the tensiometric method (UNI EN ISO 9614-2).

Super-silenced mode

SIZE	Sound pressure level	Sound power level
	dB(A)	dB(A)
2.1	37	50
3.1	38	51
4.1	39	52
5.1	39	52

Sound levels refer to units with full load under nominal test conditions. For maximum capacity delivered in silent mode use a correction factor of 0,6

Data referred to the following conditions: entering / leaving exchanger water temperature user side 47/55°C source side exchanger air inlet 7°C.

The sound pressure level refers to a distance of 1m from the external surface of the units operating in an open field.

Noise levels are determined using the tensiometric method (UNI EN ISO 9614-2).

Operational limits - Cooling

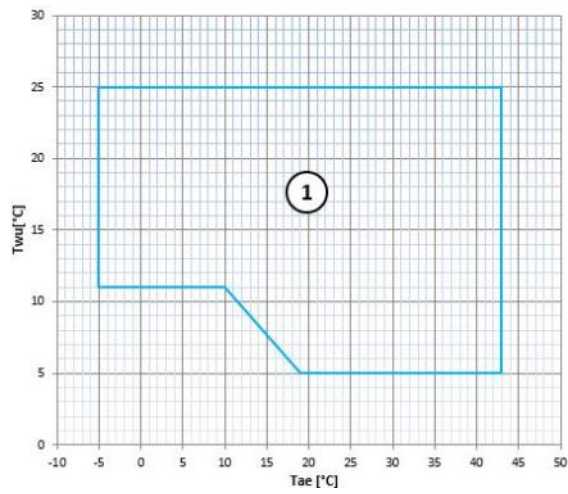

Twu [°C] = Exchanger water outlet temperature
 Tae [°C] = Outdoors exchanger air inlet temperature
 1 Normal operating range

Operational limits - Heating

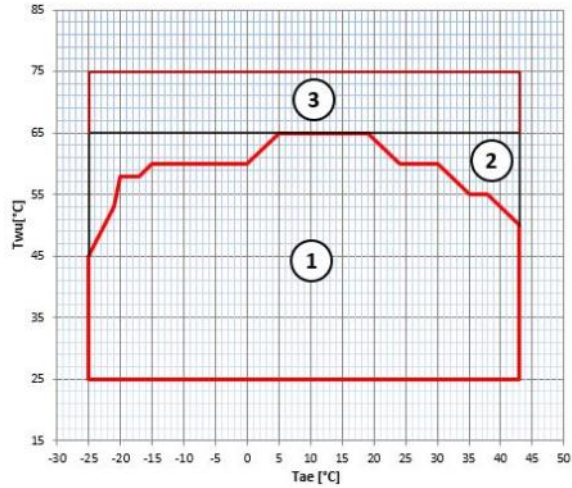

Twu [°C] = Exchanger water outlet temperature
 Tae [°C] = Outdoors exchanger air inlet temperature

- 1 Normal operating range
- 2 Operating range with additional electric heater option
- 3 Hybrid system operating range

In the configuration with electrical integration resistance, the limits vary according to the electrical power of the chosen resistance.



Boiler installation

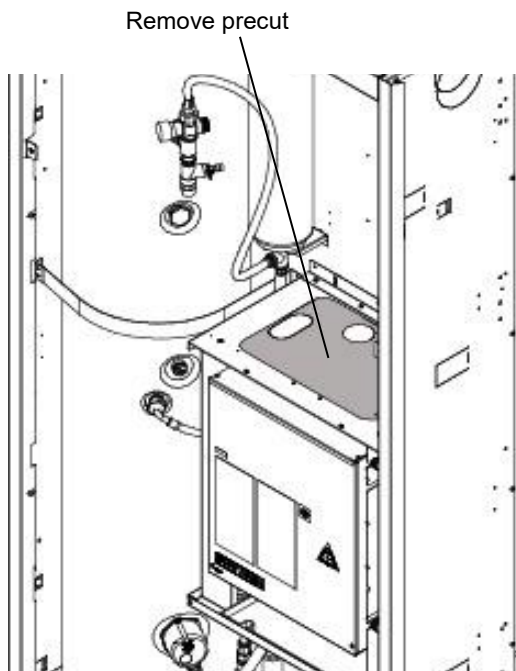

WARNING:, when removing the pre-cut, do not damage the internal components.

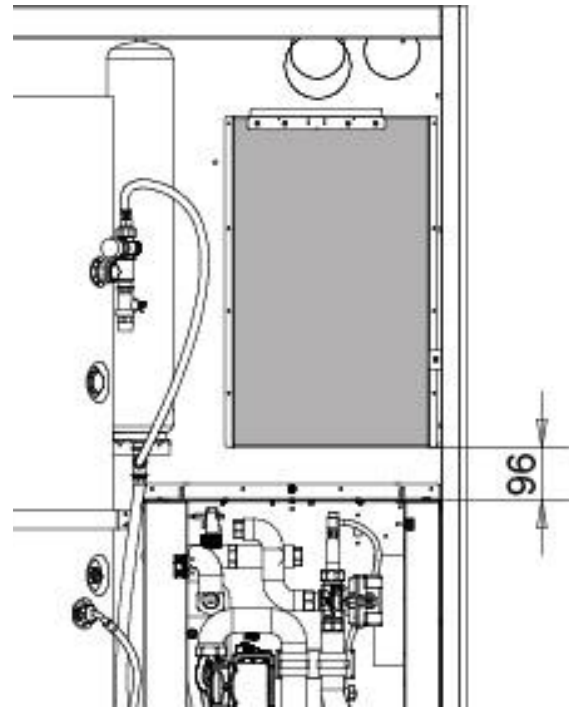

Support position

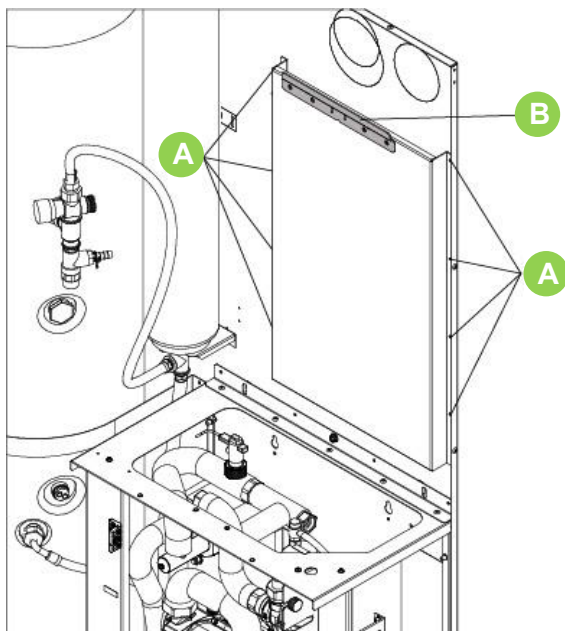

A - Fasten panel with screws
 B - Secure the bracket with structural rivets

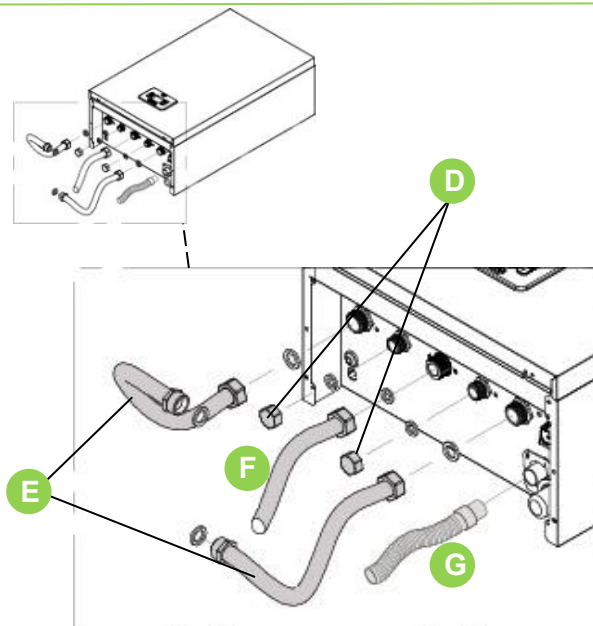

Install:

- Flexible pipes + gaskets (E)
- Gas pipe + gasket (F)
- Condensate drain pipe (G)
- Caps + gaskets (D)

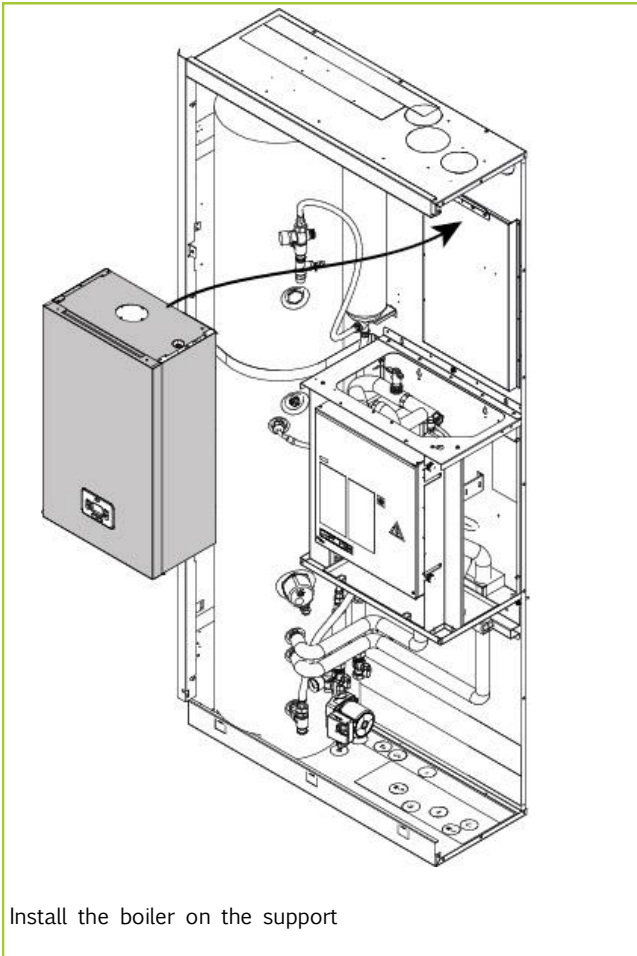

Install the boiler on the support

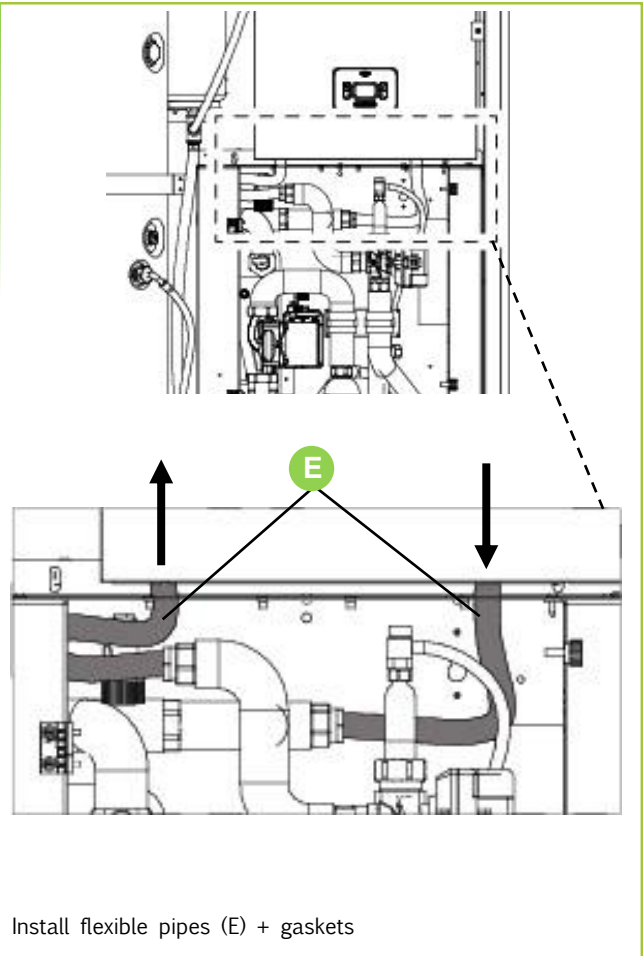

Install flexible pipes (E) + gaskets

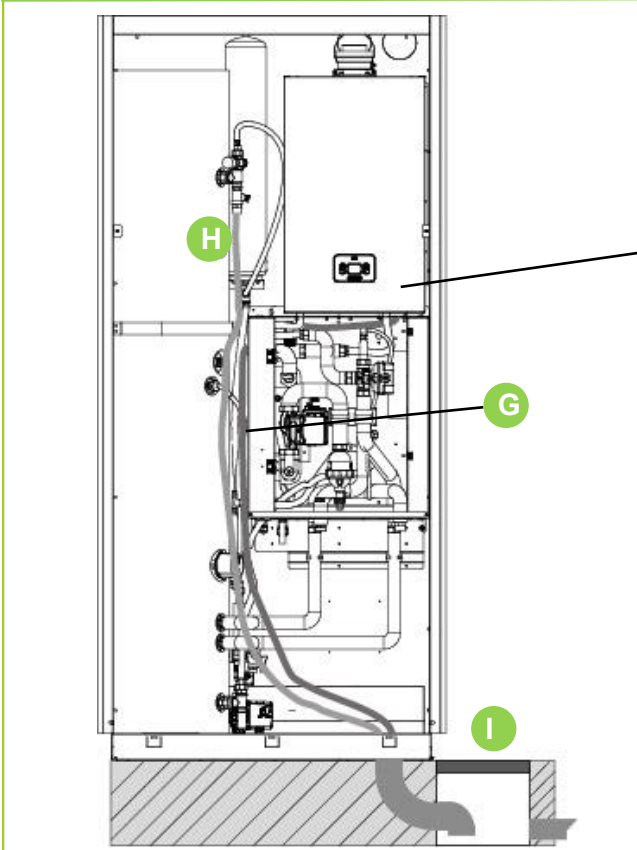

Siphon

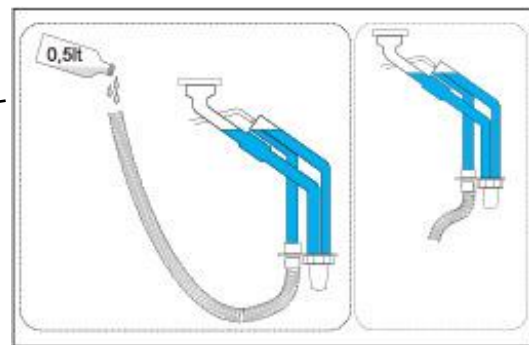

Secure the condensate drain (G) with the clamp
Secure drain safety valve (H)

Drain accumulation / drain pit (I)

The boiler condensate discharge, must be carried out properly in accordance with the legislation in force and/or national/local regulations in force for wastewater discharge.

Fill the trap (see boiler manual)





Electrical connections

Configuration, parameter access, status, alarms (see Boiler manual)

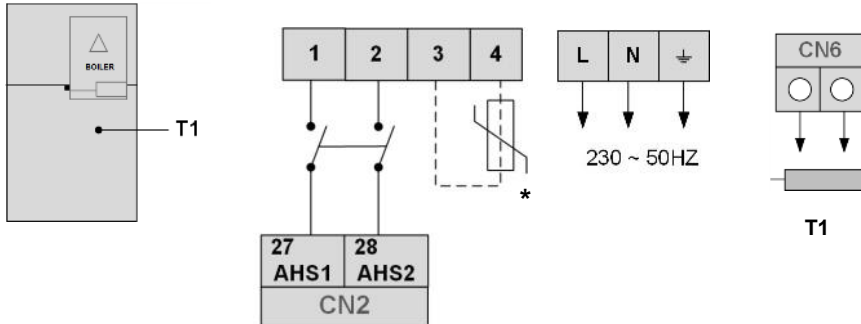

T1 = Outlet water temperature probe

* External temperature probe
(supplied with the boiler)

Boiler management

Set the setpoint on the unit keyboard and the same setpoint on the boiler keyboard.

Set the parameters: 7.4, 7.5, 7.6 (see manual in section 9 Start-up: Other heating source menu)

Boiler NO

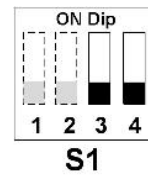

Boiler YES

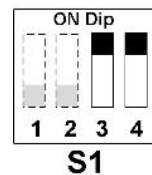



Drain pipe - by the customer

For more details: see [Boiler manual](#)

The connections to the flues and the wall drains, where admitted, have a fundamental importance for the good operation of the boiler, and must be carried out by the qualified installer in compliance with the national and local technical regulations and standards in force.

The professional is responsible for identifying the applicable dispositions, evaluate case by case the compatibility with them and the need for any changes to the processed diagrams.

Wall drains positions

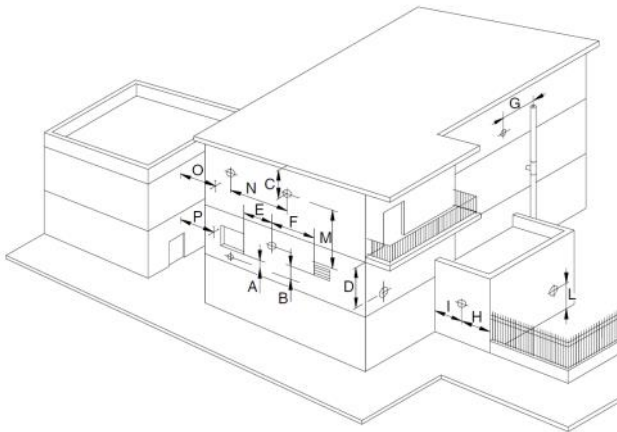

Drain positioning	Distances	Boiler
		(mm)
Underneath window	A	600
Underneath aeration opening	B	600
Underneath waterspout	C	300
Underneath balcony **	D	300
From an adjacent window	E	400
From an adjacent aeration opening	F	600
From vertical or horizontal drains or piping ***	G	300
From a corner of the building	H	300
From a recess of the building	I	300
From the ground or other ground surface	L	2500
Between two drains in vertical	M	1500
Between two drains in horizontal	N	1000
Between 2 buildings without openings or drains within a range of 3 m from the fumes outlet	O	2000
Likewise, but with openings or drains within a range of 3 m from the fumes outlet	P	3000

** The drains placed underneath the balcony must protrude over its end, including the height of the protective railing (if present), must not be < 2 m.

*** The exhaust of the drain fumes has a high temperature and must not be in contact with flammable materials (e.g. wooden attics, plastic gutters, etc...) keep at distance not < 500 mm or adopt any protective measures.

Recessed cabinet

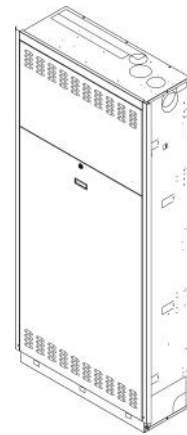

Possible coaxial tube outlets

A/S = return air / exhaust fumes

Top outlet

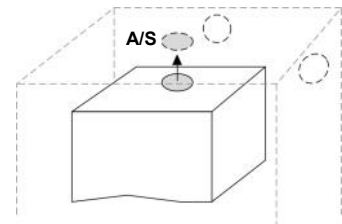

Rear outlet

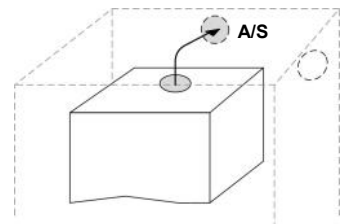

Right outlet

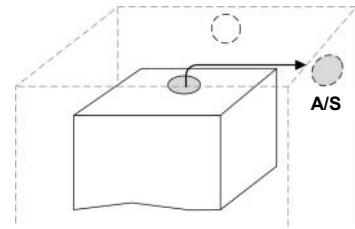



CCOAX - Horizontal coaxial curve Ø 60/100 adjustable at 360°

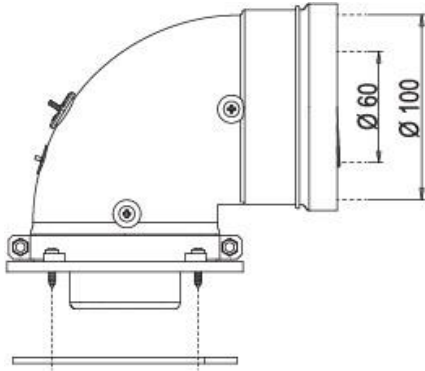

Accessory separately supplied

KSDFX - Suction and exhaust fittings 80mm diameter

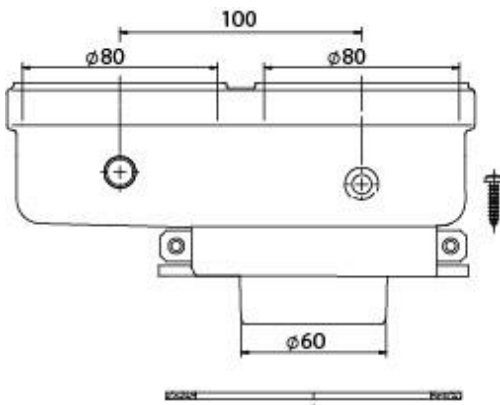

Accessory separately supplied

Coaxial drain length

It allows flue gas emission and the intake of air from the outside wall.

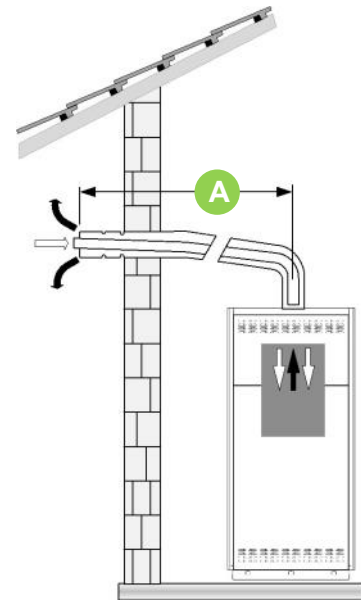

A Max 7m

Coaxial drain length

It allows flue gas emission and the intake of air directly from the roof.

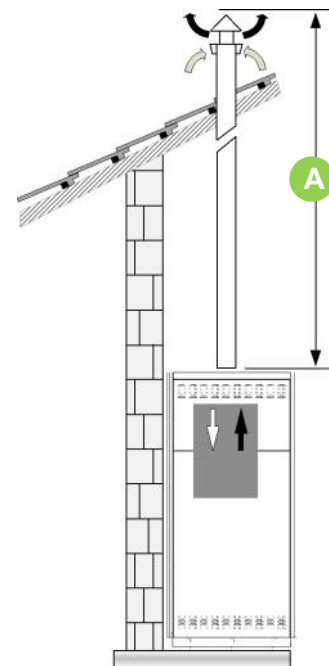

A Max 8m



Split drain length

The two-pipe system allows the flue gas emission along the flue and intake of air directly from the outside.

KSDFX - Suction and exhaust fittings 80mm diameter (accessory separately supplied)

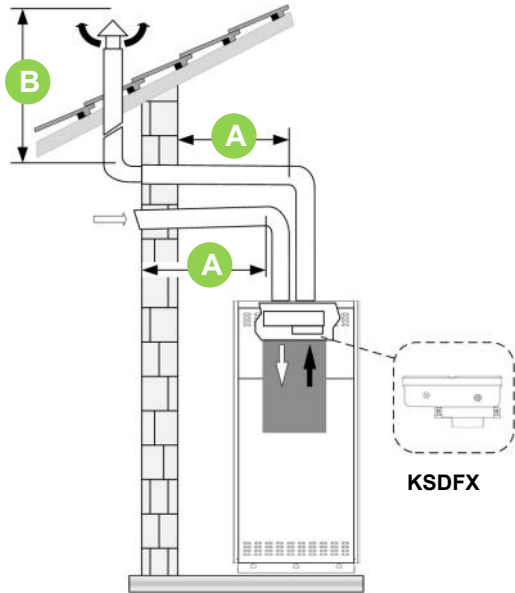

A	Max. 4 m Ø 80
B	Max. 22 m Ø 50 / Max. 60 m Ø 60

Connection to chimney, flue or wall drain where admitted, must be realised with the specific fumes drain kits (supply by the customer).

⚠ Bear in mind that the insertion of every bend on the path entails the decrease of the maximum admitted length.

Coaxial drain Ø 60/100 (horizontal)

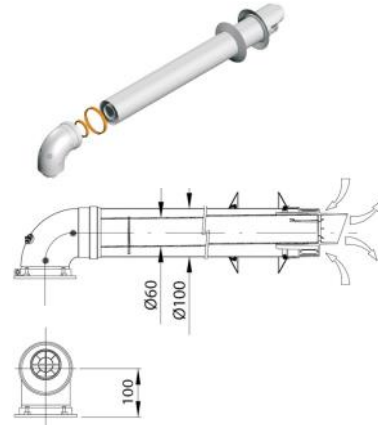

Bend		Maximum length reduction
90°		- 1 m
45°		- 0,5 m

Split drain Ø 80/80 (horizontal)

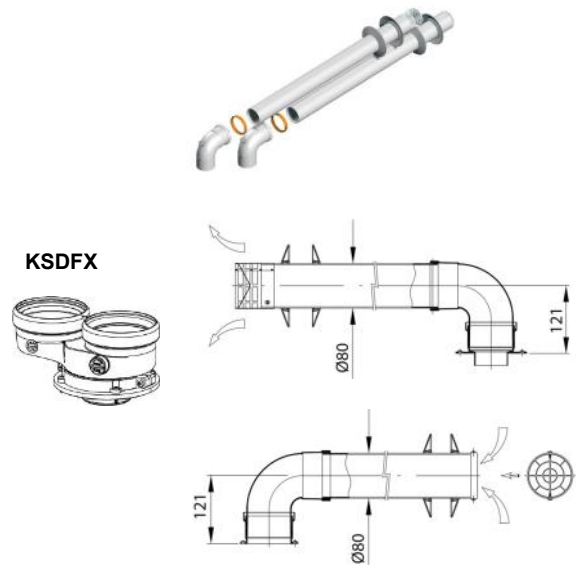

Bend		Maximum length reduction
Air intake 90°		- 1,5 m
Smoke exhaust 90°		- 2,0 m



Roof drain

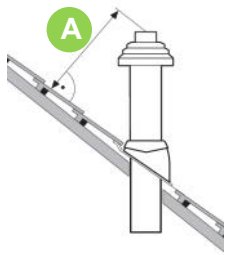

A	≥ 500	In areas with abundant snowfalls
---	-------	----------------------------------

INSTALLATION EXAMPLES

Intake

Avoid the rain input

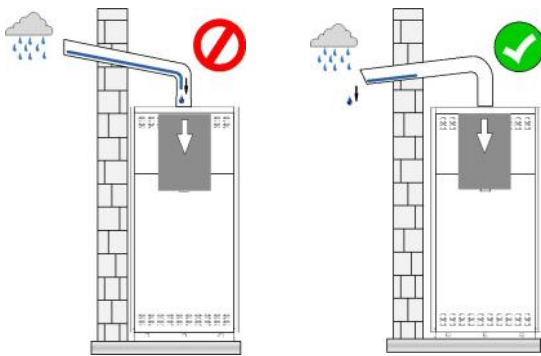

Coaxial pipes

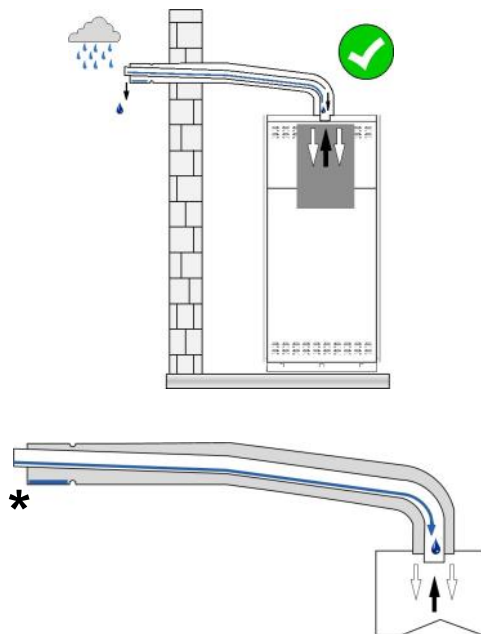

Uphill fumes, return of condensate

* Rib for rain block

Drain

The flue gas emissions and collection of condensate must be carried out correctly according to the applicable national and local technical and regulatory provisions.



Allow the condensate return

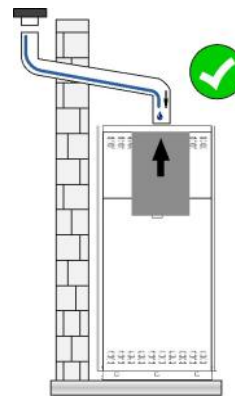

Avoid condensate stagnations

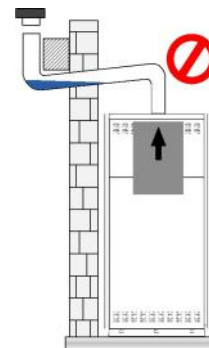

Not dripping the condensate

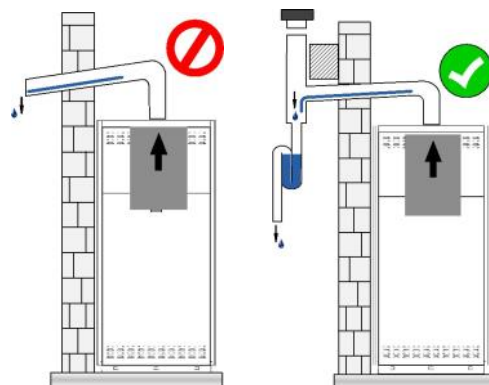



Gas line connections

The gas connection must be carried out by the qualified installer in compliance with the national standards.

- ⊘ It is strictly forbidden to use hemp or teflon to connect the boiler to the gas mains.
 - ⚠ This appliance must only be installed in adequately ventilated environments.
 - ⚠ The air inlet must be positioned at floor level in a way that cannot be obstructed and is protected with a grille that does not reduce the air passage section.
- 1 Install a shut-off cock upstream of the appliance
 - 2 Install a gas mesh filter on the tap mounted on the boiler if there is any danger of contamination of the gas
 - 3 Check the distributed gas is the one for which the boiler was designed
 - 4 The gas supply pressure falls within the values indicated on the data plate
 - 5 The piping must be equipped with all the safety and control devices prescribed by applicable law

- 6 The piping must have an adequate section according to the required flow rate and its length
 - 7 Clean all gas supply system piping to avoid any residues that might jeopardise the good operation of the boiler
 - 8 Check the gas supply line is conform with the current prescriptions and standards
 - 9 Check internal and external seal of the system and of the gas connections
 - 10 Open the meter cock and bleed any air contained inside the system piping.
- A. Gas inlet \varnothing 3/4" M flat seat.
 B. Route the gas tube into the casing
 C. Boiler gas hose routing

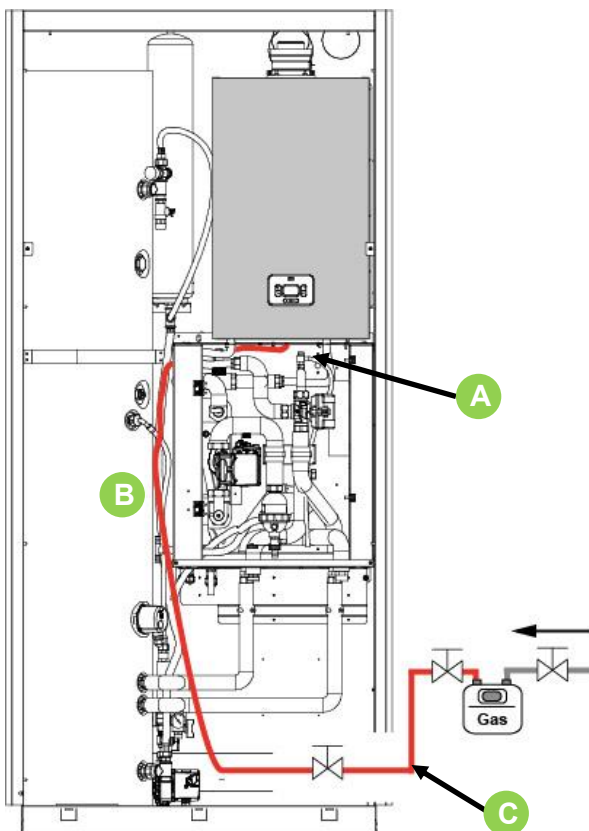

The boiler can function with the following modes :

- domestic hot water production in case of heat pump switch-off for inadequate functioning conditions (low external temperature)
- system heating without domestic hot water request and in case the heat pump is unable to reach the setpoint set within the envisioned times
- antilegionella cycles in the domestic hot water
- domestic hot water (it is not instantaneous, the accumulation is heated through the exchange coil) and system heating in integration, in replacement or in case of fault of the heat pump.

It is not possible to request electric heaters instead of the standard condensing boiler.

The system expansion vessel is the one in the boiler. ⚠

15 ENERGY DATA SHEETS AND LABELLING

Modello info prodotto /Product info template

Information requirements for heat pump space heaters and heat pump combination heaters. Informazioni obbligatorie per gli apparecchi a pompa di calore per il riscaldamento d'ambiente e gli apparecchi di riscaldamento misti a pompa di calore							
Model(s) / Modelli:		aa					
Air-to-water heat pump: / Pompa di calore aria/acqua:		ab					
Water-to-water heat pump: / Pompa di calore acqua/acqua:		ac					
Brine-to-water heat pump: / Pompa di calore salamoia/acqua:		ad					
Low-temperature heat pump: / Pompa di calore a bassa temperatura:		ae					
Equipped with a supplementary heater: / Con riscaldatore supplementare:		af					
Heat pump combination heater: / Apparecchio misto a pompa di calore:		ag					
Heat pump combination heater: / Apparecchio misto a pompa di calore: Parameters shall be declared for medium-temperature application, except for low-temperature heat pumps. For low-temperature heat pumps, parameters shall be declared for low-temperature application. / I parametri sono dichiarati per l'applicazione a temperatura media, tranne per le pompe di calore a bassa temperatura Per le pompe di calore a bassa temperatura, i parametri sono dichiarati per l'applicazione a bassa temperatura.							
Parameters shall be declared for average climate conditions. / I parametri sono dichiarati per condizioni climatiche medie.							
Item / Elemento	Symbol / Simbolo	Value / Valore	Unit / Unità	Item / Elemento	Symbol / Simbolo	Value / Valore	Unit / Unità
Rated heat output (*) / Potenza termica nominale (*)	<i>Prated</i>	ah	kW	Seasonal space heating energy efficiency / Efficienza energetica stagionale del riscaldamento d'ambiente	<i>ηs</i>	ai	%
Declared capacity for heating for part load at indoor temperature 20 °C and outdoor temperature Tj / Capacità di riscaldamento dichiarata a carico parziale, con temperatura interna pari a 20 °C e temperatura esterna Tj				Declared coefficient of performance or primary energy ratio for part load at indoor temperature 20 °C and outdoor temperature Tj / Coefficiente di prestazione dichiarato o indice di energia primaria per carico parziale, con temperatura interna pari a 20 °C e temperatura esterna Tj			
<i>Tj = - 7 °C</i>	<i>Pdh</i>	aj	kW	<i>Tj = - 7 °C</i>	<i>COPd</i>	at	-
<i>Tj = + 2 °C</i>	<i>Pdh</i>	ak	kW	<i>Tj = + 2 °C</i>	<i>COPd</i>	au	-
<i>Tj = + 7 °C</i>	<i>Pdh</i>	al	kW	<i>Tj = + 7 °C</i>	<i>COPd</i>	av	-
<i>Tj = + 12 °C</i>	<i>Pdh</i>	am	kW	<i>Tj = + 12 °C</i>	<i>COPd</i>	aw	-
Tj = bivalent temperature / Temperatura bivalente	<i>Pdh</i>	an	kW	Tj = bivalent temperature / Temperatura bivalente	<i>COPd</i>	ax	-
Tj = operation limit temperature / temperatura limite di esercizio	<i>Pdh</i>	ao	kW	Tj = operation limit temperature / temperatura limite di esercizio	<i>COPd</i>	ay	-
For air-to-water heat pumps: Tj = - 15 °C (if TOL < - 20 °C) / Per le pompa di calore aria/ acqua: T j = - 15 °C (se TOL < - 20 °C)	<i>Pdh</i>	ap	kW	For air-to-water heat pumps: Tj = - 15 °C (if TOL < - 20 °C) / Per le pompa di calore aria/ acqua: T j = - 15 °C (se TOL < - 20 °C)	<i>COPd</i>	az	-
Bivalent temperature / Temperatura bivalente	<i>Tbiv</i>	aq	°C	For air-to-water heat pumps: Operation limit temperature / Per le pompe di calore aria/ acqua: temperatura limite di esercizio	<i>TOL</i>	ba	°C
Cycling interval capacity for heating / Ciclicità degli intervalli di capacità per il riscaldamento	<i>Pcych</i>	ar	kW	Cycling interval efficiency / Efficienza della ciclicità degli intervalli	<i>COPcych</i>	bb	-
Degradation co-efficient (**)/ Coefficiente di degradazione (**)	<i>Cdh</i>	as	-	Heating water operating limit temperature / Temperatura limite di esercizio di riscaldamento dell'acqua	<i>WTOL</i>	bc	-

Power consumption in modes other than active mode / Consumo energetico in modi diversi dal modo attivo				Supplementary heater / Riscaldatore supplementare			
Off mode / Modo spento	<i>POFF</i>	bd	kW	Rated heat output (*) / Potenza termica nominale (*)	<i>Psup</i>	bh	kW
Thermostat-off mode / Modo termostato spento	<i>PTO</i>	be	kW				
Standby mode / Modo stand-by	<i>PSB</i>	bf	kW	Type of energy input / Tipo di alimentazione energetica	bi		
Crankcase heater mode / Modo riscaldamento del carter	<i>PCK</i>	bg	kW				
Other items / Altri elementi							
Capacity control / Controllo della capacità	bj		For air-to-water heat pumps: Rated air flow rate, outdoors / Per le pompe di calore aria/ acqua: portata d'aria, all'esterno		-	bm	m3/h
Sound power level, indoors/outdoors / Livello della potenza sonora, all'interno/all'esterno	<i>LWA</i>	bk	dB(A)	For water-/brine-to-water heat pumps: Rated brine or water flow rate, outdoor heat exchanger / Per le pompe di calore acqua/acqua e salamoia/acqua: flusso di salamoia o acqua nominale, scambiatore di calore all'esterno	-	bn	m3/h
Annual energy consumption / Consumo energetico annuo	<i>QHE</i>	bl	kWh				
For heat pump combination heater: / Per gli apparecchi di riscaldamento misti a pompa di calore:							
Declared load profile / Profilo di carico dichiarato	bo		Water heating energy efficiency / Efficienza energetica di riscaldamento dell'acqua		<i>ηwh</i>	bq	-
Daily electricity consumption / Consumo quotidiano di energia elettrica	<i>Qelec</i>	bp	kWh	Daily fuel consumption / Consumo quotidiano di combustibile	<i>Qfuel</i>	br	kWh
Annual electricity consumption / Consumo annuo di energia elettrica	<i>AEC</i>	bs	kWh	Annual fuel consumption / Consumo annuo di combustibile	<i>AFC</i>	bt	GJ
Contact details: / Recapiti:	CLIVET SPA - VIA CAMP LONC, 25 - Z.I. VILLAPAIERA - 32032 FELTRE (BL) - ITALY						
(*) For heat pump space heaters and heat pump combination heaters, the rated heat output Prated is equal to the design load for heating Pdesignh, and the rated heat output of a supplementary heater Psup is equal to the supplementary capacity for heating sup(Tj). (**) If Cdh is not determined by measurement then the default degradation coefficient is Cdh = 0,9. / (*) Per gli apparecchi a pompa di calore per il riscaldamento d'ambiente e gli apparecchi di riscaldamento misti a pompa di calore, la potenza termica nominale Pnominale è pari al carico teorico per il riscaldamento Pdesignh e la potenza termica nominale di un riscaldatore supplementare Psup è pari alla capacità supplementare di riscaldamento sup(Tj). (**) Se Cdh non è determinato mediante misurazione, il coefficiente di degradazione è Cdh = 0,9.							

Modello scheda prodotto / Product card model

Product fiche: combination heaters Scheda prodotto: apparecchi di riscaldamento misti			
SERIES / Serie	ca		
Model / Modello	1	-	cb
Size / Grandezza	2	-	cc
Medium-temperature application / Applicazione a media temperatura	3	°C	cd
Low-temperature application / Applicazione a bassa temperatura	4	°C	ce
DHW profile / Profilo ACS	5	-	cf
Medium-temperature class / Classe a media temperatura	6	-	cg
Low-temperature class / Classe a bassa temperatura	7	-	ch
DHW class / Classe ACS	8	-	ci
P _{tn}	9	kW	cj
Q _{he_ambiente}	10	kWh	ck
Q _{he_acs}	11	kWh	cl
η _s	12	%	cm
η _{s_Wh}	13	%	cn
L _{WA_in}	14	dB	co
FOM	15	-	cp
Precautions / Precauzioni	16	See installation and operating manual / Vedi manuale di uso e manutenzione	
P _{th_colder}	17	kW	cq
P _{th_warmer}	18	kW	cr
Q _{HE_colder}	19	kWh	cs
Q _{HE_warmer}	20	kWh	ct
Q _{HE_colder_Wh}	21	kWh	cu
Q _{HE_warmer_Wh}	22	kWh	cv
η _{s_colder}	23	%	cw
η _{s_warmer}	24	%	cx
η _{s_colder_Wh}	25	%	cy
η _{s_warmer_Wh}	26	%	cz
L _{WA_out}	27	dB	da

Product fiche: temperature control / Scheda prodotto: dispositivi di controllo della temperatura			
SERIES / Serie	ca		
Model / Modello	1	-	cb
Size / Grandezza	2	-	cc
Device class	3	-	db
η_s	4	%	dc

Product fiche: packages of combination heater, temperature control and solar device / Scheda prodotto: insiemi di apparecchi di riscaldamento misti, dispositivi di controllo della temperatura e dispositivi solari			
I	1	%	cm
II	2	-	dd
III	3	-	de
IV	4	-	df
V	5	-	dg
VI	6	-	dh
Control class T / Classe controllo T	7	%	db
$\eta_{s_caldaia}$	8	%	di
Collector / Collettore	9	m ²	dj
V serbatoio	10	m ³	dk
$\eta_{collettore}$	11	%	dl
Storage Tank Class / Classe serbatoio	12	-	dm
Energy Efficiency / Efficienza energetica	13	%	dn
Energy Efficiency C / Efficienza energetica C	14	%	do
Energy Efficiency W / Efficienza energetica W	15	%	dp
I	16	%	cn
II	17	-	dq
III	18	-	dr
Load Profile / Profilo di carico	19	-	cf
η_{s_wh}	20	%	cn
$\eta_{s_wh_colder}$	21	%	cy
$\eta_{s_wh_warmer}$	22	%	cz

Media temperatura / medium-temperature

ID	Description	Symbol	2,1	3,1	4,1	5,1
aa	Model(s) / Modelli:	-	SQKN-YEE 1 IC MISAN-YEE 1 S 2.1	SQKN-YEE 1 IC MISAN-YEE 1 S 3.1	SQKN-YEE 1 IC MISAN-YEE 1 S 4.1	SQKN-YEE 1 IC MISAN-YEE 1 S 5.1
ab	Air-to-water heat pump: / Pompa di calore aria/acqua:	-	YES	YES	YES	YES
ac	Water-to-water heat pump: / Pompa di calore acqua/acqua:	-	NO	NO	NO	NO
ad	Brine-to-water heat pump: / Pompa di calore salamoia/acqua:	-	NO	NO	NO	NO
ae	Low-temperature heat pump: / Pompa di calore a bassa temperatura:	-	NO	NO	NO	NO
af	Equipped with a supplementary heater: / Con riscaldatore supplementare:	-	NO	NO	NO	NO
ag	Heat pump combination heater: / Apparecchio misto a pompa di calore:	-	YES	YES	YES	YES
ah	Rated heat output (*) / Potenza termica nominale (*)	Prated	4,08	6	7	9
ai	Seasonal space heating energy efficiency / Efficienza energetica stagionale del riscaldamento d'ambiente	η_s	130	139	146	146
aj	T _j = - 7 °C	Pdh	3,61	4,97	6,09	7,58
ak	T _j = + 2 °C	Pdh	2,16	3,02	3,94	4,44
al	T _j = + 7 °C	Pdh	1,54	2,00	2,52	2,92
am	T _j = + 12 °C	Pdh	1,29	1,30	1,72	1,74
an	T _j = bivalent temperature / Temperatura bivalente	Pdh	3,61	4,97	6,09	7,58
ao	T _j = operation limit temperature / Temperatura limite di esercizio	Pdh	3,91	5,27	4,97	5,46
ap	For air-to-water heat pumps: T _j = - 15 °C (if TOL < - 20 °C) / Per le pompe di calore aria/ acqua: T _j = - 15 °C (se TOL < - 20 °C)	Pdh	-	-	-	-
aq	Bivalent temperature / Temperatura bivalente	Tbiv	-7	-7	-7	-7
ar	Cycling interval capacity for heating / Ciclicità degli intervalli di capacità per il riscaldamento	Pcych	-	-	-	-
as	Degradation co-efficient (**)/ Coefficiente di degradazione (**)	Cdh	0,9	0,9	0,9	0,9
at	T _j = - 7 °C	COPd	2,02	2,12	2,27	2,02
au	T _j = + 2 °C	COPd	3,21	3,41	3,56	3,63
av	T _j = + 7 °C	COPd	4,43	4,82	4,70	4,95
aw	T _j = + 12 °C	COPd	6,20	6,32	9,71	9,87
ax	T _j = bivalent temperature / Temperatura bivalente	COPd	2,02	2,12	2,27	2,02
ay	T _j = operation limit temperature / Temperatura limite di esercizio	COPd	1,68	1,64	1,88	1,87
az	For air-to-water heat pumps: T _j = - 15 °C (if TOL < - 20 °C) / Per le pompe di calore aria/ acqua: T _j = - 15 °C (se TOL < - 20 °C)	COPd	-	-	-	-
ba	For air-to-water heat pumps: Operation limit temperature / Per le pompe di calore aria/ acqua: temperatura limite di esercizio	TOL	-10	-10	-10	-10
bb	Cycling interval efficiency / Efficienza della ciclicità degli intervalli	COPcych	-	-	-	-
bc	Heating water operating limit temperature / Temperatura limite di esercizio di riscaldamento dell'acqua	WTOL	65	65	65	65
bd	Off mode / Modo spento	POFF	0,015	0,015	0,015	0,015
be	Thermostat-off mode / Modo termostato spento	PTO	0,015	0,015	0,015	0,015
bf	Standby mode / Modo stand-by	PSB	0,015	0,015	0,015	0,015
bg	Crankcase heater mode / Modo riscaldamento del carter	PCK	0	0	0	0
bh	Rated heat output (*) / Potenza termica nominale (*)	Psup	0,2	0,4	1,9	3,1
bi	Type of energy input / Tipo di alimentazione energetica		-	-	-	-
bj	Capacity control / Controllo della capacità		Variable / Variabile	Variable / Variabile	Variable / Variabile	Variable / Variabile
bl	Sound power level, indoors/outdoors / Livello della potenza sonora, all'interno/all'esterno	LWA	41/55	41/57	41/58	41/60
bl	Annual energy consumption / Consumo energetico annuale	kWh	2541,609759	3283	3824	4749
bm	For air-to-water heat pumps: Rated air flow rate, outdoors / Per le pompe di calore aria/ acqua: portata d'aria, all'esterno		2750	3000	4750	5000
bn	For water-/brine-to-water heat pumps: Rated brine or water flow rate, outdoor heat exchanger /		-	-	-	-
bo	Declared load profile / Profilo di carico dichiarato		L	L	L	L
bp	Daily electricity consumption / Consumo quotidiano di energia elettrica	Qelec	4,128	4,128	4,272	4,272
bq	Water heating energy efficiency / Efficienza energetica di riscaldamento dell'acqua	η_{wh}	115	115	115	115
br	Daily fuel consumption / Consumo quotidiano di combustibile	Qfuel	-	-	-	-
bs	Annual electricity consumption / Consumo annuo di energia elettrica	AEC	852	852	880	880
bt	Annual fuel consumption / Consumo annuo di combustibile	AEF	-	-	-	-

ID	Description	Symbol	2,1	3,1	4,1	5,1
ca	SERIES / Serie	-	SPHERA EVO 2.0	SPHERA EVO 2.0	SPHERA EVO 2.0	SPHERA EVO 2.0
cb	Model / Modello	-	SQKN-YEE 1 IC MISAN-YEE 1 S	SQKN-YEE 1 IC MISAN-YEE 1 S	SQKN-YEE 1 IC MISAN-YEE 1 S	SQKN-YEE 1 IC MISAN-YEE 1 S
cc	Size / Grandezza	-	2,1	3,1	4,1	5,1
cd	Medium-temperature application / Applicazione a media temperatura	°C	55	55	55	55
ce	Low-temperature application / Applicazione a bassa temperatura	°C	35	35	35	35
cf	DHW profile / Profilo ACS	-	L	L	L	L
cg	Medium-temperature class / Classe a media temperatura	-	A++	A++	A++	A++
ch	Low-temperature class / Classe a bassa temperatura	-	A+++	A+++	A+++	A+++
ci	DHW class / Classe ACS	-	A+	A+	A+	A+
cj	Ptn	kW	4	6	7	9
ck	Qhe_ambiente	kWh	2542	3283	3824	4749
cl	Qhe_acs	kWh	852	852	880	880
cm	η_s	%	130	139	146	146
cn	η_{s_wh}	%	115	115	115	115
co	LwA_in	dB(A)	41	41	41	41
cp	FOM	-	-	-	-	-
cq	P th_colder	kW	4	5	7	8
cr	P th_warmer	kW	5	7	9	11
cs	Q HE_colder	kWh	3164	4087	4761	5914
ct	Q HE_warmer	kWh	1719	2217	2581	3204
cu	Q HE_colder_wh	kWh	985	985	1205	1205
cv	Q HE_warmer_wh	kWh	826	826	759	759
cw	η_{s_colder}	%	118	126	132	133
cx	η_{s_warmer}	%	163	174	183	184
cy	$\eta_{s_colder_wh}$	%	104	104	85	85
cz	$\eta_{s_warmer_wh}$	%	124	124	135	135
da	LwA_out	dB(A)	55	57	58	60
db	Device class	-	VIII	VIII	VIII	VIII
dc	η_s	%	5	5	5	5
dd	II	-	-	-	-	-
de	III	-	7	5	4	3
df	IV	-	3	2	2	1
dg	V	-	12	13	14	13
dh	VI	-	33	35	37	38
di	$\eta_{s_caldaia}$	%	-	-	-	-
dj	Collector / Collettore	m2	-	-	-	-
dk	V serbatoio	m3	-	-	-	-
dl	$\eta_{collettore}$	%	-	-	-	-
dm	Storage Tank Class / Classe serbatoio	-	-	-	-	-
dn	Energy Efficiency / Efficienza energetica	%	135	144	151	151
do	Energy Efficiency C / Efficienza energetica C	%	123	131	137	138
dp	Energy Efficiency W / Efficienza energetica W	%	168	179	188	189
dq	II	-	-	-	-	-
dr	III	-	-	-	-	-

Bassa temperatura / low-temperature

ID	Description	Symbol	2,1	3,1	4,1	5,1
aa	Model(s) / Modelli:	-	SQKN-YEE 1 IC MiSAN-YEE 1 S 2.1	SQKN-YEE 1 IC MiSAN-YEE 1 S 3.1	SQKN-YEE 1 IC MiSAN-YEE 1 S 4.1	SQKN-YEE 1 IC MiSAN-YEE 1 S 5.1
ab	Air-to-water heat pump: / Pompa di calore aria/acqua:	-	YES	YES	YES	YES
ac	Water-to-water heat pump: / Pompa di calore acqua/acqua:	-	NO	NO	NO	NO
ad	Brine-to-water heat pump: / Pompa di calore salamoia/acqua:	-	NO	NO	NO	NO
ae	Low-temperature heat pump: / Pompa di calore a bassa temperatura:	-	YES	YES	YES	YES
af	Equipped with a supplementary heater: / Con riscaldatore supplementare:	-	NO	NO	NO	NO
ag	Heat pump combination heater: / Apparecchio misto a pompa di calore:	-	YES	YES	YES	YES
ah	Rated heat output (*) / Potenza termica nominale (*)	Prated	5	6	8	10
ai	Seasonal space heating energy efficiency / Efficienza energetica stagionale del riscaldamento d'ambiente	ηs	202	203	210	208
aj	Tj = -7 °C	Pdh	4,74	5,51	7,15	8,45
ak	Tj = +2 °C	Pdh	3,05	3,30	4,65	5,23
al	Tj = +7 °C	Pdh	1,99	2,24	2,91	3,47
am	Tj = +12 °C	Pdh	1,45	1,45	1,85	1,96
an	Tj = bivalent temperature / Temperatura bivalente	Pdh	4,74	5,51	7,15	8,45
ao	Tj = operation limit temperature / Temperatura limite di esercizio	Pdh	5,21	5,80	6,42	7,38
ap	For air-to-water heat pumps: Tj = -15 °C (if TOL < -20 °C) / Per le pompe di calore aria/acqua: Tj = -15 °C (se TOL < -20 °C)	Pdh	-	-	-	-
aq	Bivalent temperature / Temperatura bivalente	Tbiv	-7	-7	-7	-7
ar	Cycling interval capacity for heating / Ciclicità degli intervalli di capacità per il riscaldamento	Ppsych	-	-	-	-
as	Degradation co-efficient (**)/ Coefficiente di degradazione (**)	Cdh	0,9	0,9	0,9	0,9
at	Tj = -7 °C	COPd	3,15	3,13	3,30	3,18
au	Tj = +2 °C	COPd	4,96	4,91	5,17	5,03
av	Tj = +7 °C	COPd	6,81	7,11	7,08	7,33
aw	Tj = +12 °C	COPd	8,94	8,94	9,46	9,94
ax	Tj = bivalent temperature / Temperatura bivalente	COPd	3,15	3,13	3,30	3,18
ay	Tj = operation limit temperature / Temperatura limite di esercizio	COPd	2,86	2,70	3,06	2,97
az	For air-to-water heat pumps: Tj = -15 °C (if TOL < -20 °C) / Per le pompe di calore aria/acqua: Tj = -15 °C (se TOL < -20 °C)	COPd	-	-	-	-
ba	For air-to-water heat pumps: Operation limit temperature / Per le pompe di calore aria/acqua: temperatura limite di esercizio	TOL	-10	-10	-10	-10
bb	Cycling interval efficiency / Efficienza della ciclicità degli intervalli	COPpsych	-	-	-	-
bc	Heating water operating limit temperature / Temperatura limite di esercizio di riscaldamento dell'acqua	WTOL	65	65	65	65
bd	Off mode / Modo spento	POFF	0,015	0,015	0,015	0,015
be	Thermostat-off mode / Modo termostato spento	PTO	0,015	0,015	0,015	0,015
bf	Standby mode / Modo stand-by	PSB	0,015	0,015	0,015	0,015
bg	Crankcase heater mode / Modo riscaldamento del carter	PCK	0	0	0	0
bh	Rated heat output (*) / Potenza termica nominale (*)	Psup	0,2	0,4	1,9	3,1
bi	Type of energy input / Tipo di alimentazione energetica		-	-	-	-
bj	Capacity control / Controllo della capacità		Variable / Variabile	Variable / Variabile	Variable / Variabile	Variable / Variabile
bl	Sound power level, indoors/outdoors / Livello della potenza sonora, all'interno/all'esterno	LWA	41/55	41/57	41/58	41/60
bl	Annual energy consumption / Consumo energetico annuale	kWh	2161	2502	3141	3747
bm	For air-to-water heat pumps: Rated air flow rate, outdoors / Per le pompe di calore aria/acqua: portata d'aria, all'esterno		2750	3000	4750	5000
bn	For water-/brine-to-water heat pumps: Rated brine or water flow rate, outdoor heat exchanger / Per le pompe di calore acqua/acqua e salamoia/acqua: flusso di salamoia o acqua nominale, scambiatore di calore all'esterno		-	-	-	-
bo	Declared load profile / Profilo di carico dichiarato		L	L	L	L
bp	Daily electricity consumption / Consumo quotidiano di energia elettrica	Qelec	4,128	4,128	4,272	4,272
bq	Water heating energy efficiency / Efficienza energetica di riscaldamento dell'acqua	ηwh	115	115	115	115
br	Daily fuel consumption / Consumo quotidiano di combustibile	Qfuel	-	-	-	-
bs	Annual electricity consumption / Consumo annuo di energia elettrica	AEC	852	852	880	880
bt	Annual fuel consumption / Consumo annuo di combustibile	AEF	-	-	-	-

ID	Description	Symbol	2,1	3,1	4,1	5,1
ca	SERIES / Serie	-	SPHERA EVO 2.0	SPHERA EVO 2.0	SPHERA EVO 2.0	SPHERA EVO 2.0
cb	Model / Modello	-	SQKN-YEE 1 IC MISAN-YEE 1 S	SQKN-YEE 1 IC MISAN-YEE 1 S	SQKN-YEE 1 IC MISAN-YEE 1 S	SQKN-YEE 1 IC MISAN-YEE 1 S
cc	Size / Grandezza	-	2,1	3,1	4,1	5,1
cd	Medium-temperature application / Applicazione a media temperatura	°C	55	55	55	55
ce	Low-temperature application / Applicazione a bassa temperatura	°C	35	35	35	35
cf	DHW profile / Profilo ACS	-	L	L	L	L
cg	Medium-temperature class / Classe a media temperatura	-	A++	A++	A++	A++
ch	Low-temperature class / Classe a bassa temperatura	-	A+++	A+++	A+++	A+++
ci	DHW class / Classe ACS	-	A+	A+	A+	A+
cj	Ptn	kW	4	6	7	9
ck	Qhe_ambiente	kWh	2161	2502	3141	3747
cl	Qhe_acs	kWh	852	852	880	880
cm	η_s	%	130	139	146	146
cn	η_{s_wh}	%	115	115	115	115
co	LwA_in	dB(A)	41	41	41	41
cp	FOM	-	-	-	-	-
cq	P th_colder	kW	5	6	8	10
cr	P th_warmer	kW	7	8	10	12
cs	Q HE_colder	kWh	3245	3830	4808	5737
ct	Q HE_warmer	kWh	1513	1750	2194	2615
cu	Q HE_colder_wh	kWh	985	985	1205	1205
cv	Q HE_warmer_wh	kWh	826	826	759	759
cw	η_{s_colder}	%	163	164	169	168
cx	η_{s_warmer}	%	241	242	250	248
cy	$\eta_{s_colder_wh}$	%	104	104	85	85
cz	$\eta_{s_warmer_wh}$	%	124	124	135	135
da	LwA_out	dB(A)	55	57	58	60
db	Device class	-	VIII	VIII	VIII	VIII
dc	η_s	%	5	5	5	5
dd	II	-	-	-	-	-
de	III	-	7	5	4	3
df	IV	-	3	2	2	1
dg	V	-	12	13	14	13
dh	VI	-	33	35	37	38
di	$\eta_{s_caldaia}$	%	-	-	-	-
dj	Collector / Collettore	m2	-	-	-	-
dk	V serbatoio	m3	-	-	-	-
dl	η collettore	%	-	-	-	-
dm	Storage Tank Class / Classe serbatoio	-	-	-	-	-
dn	Energy Efficiency / Efficienza energetica	%	135	144	151	151
do	Energy Efficiency C / Efficienza energetica C	%	123	131	137	138
dp	Energy Efficiency W / Efficienza energetica W	%	168	179	188	189
dq	II	-	-	-	-	-
dr	III	-	-	-	-	-

Dati tecnici per soluzione ibrida, sostituiscono i dati delle tabelle precedenti / Technical data for hybrid solution, replace the data in the previous tables

ID	Description	Symbol	24,2				24,4				34,4						
<i>af</i>	Equipped with a supplementary heater: / Con riscaldatore supplementare:	-	YES				YES				YES						
<i>ah</i>	Rated heat output (*) / Potenza termica nominale (*)	<i>Prated</i>	4	6	7	9	4	6	7	9	4	6	7	9	12	13	13
<i>ai</i>	Seasonal space heating energy efficiency / Efficienza energetica stagionale del riscaldamento	<i>ηs</i>	130	139	146	146	130	139	146	146	130	139	146	146	140	138	136
<i>bh</i>	Rated heat output (*) / Potenza termica nominale (*)	<i>Psup</i>	24				24				34						
<i>bi</i>	Type of energy input / Tipo di alimentazione energetica		Natural gas / Gas naturale				Natural gas / Gas naturale				Natural gas / Gas naturale						
<i>cc</i>	Size / Grandezza	-	2,1	3,1	4,1	5,1	2,1	3,1	4,1	5,1	2,1	3,1	4,1	5,1	6,1	7,1	8,1
<i>dd</i>	II	-	0,57	0,47	0,40	0,33	0,57	0,47	0,40	0,33	0,67	0,58	0,52	0,45	0,34	0,31	0,30
<i>dg</i>	V	-	12	13	14	13	12	13	14	13	12	13	14	13	13	13	12
<i>dh</i>	VI	-	33	35	37	38	33	35	37	38	33	35	37	38	35	35	35
<i>di</i>	<i>ηs_caldaia</i>	%	94				94				94						
<i>dn</i>	Energy Efficiency / Efficienza energetica	%	114	123	130	134	114	123	130	134	111	118	124	128	129	129	129
<i>do</i>	Energy Efficiency C / Efficienza energetica C	%	102	110	116	121	102	110	116	121	99	105	110	115	117	116	116
<i>dp</i>	Energy Efficiency W / Efficienza energetica W	%	147	158	167	172	147	158	167	172	144	153	161	166	165	164	163

ENERGY

енергия · ενεργεια



ENERGY

енергия · ενεργεια



SQKN-YEE 1 IC + MiSAN-Y
EE 1 S 2.1

SQKN-YEE 1 IC + MiSAN
-YEE 1 S 2.1

Clivet S.p.A.

Clivet S.p.A.

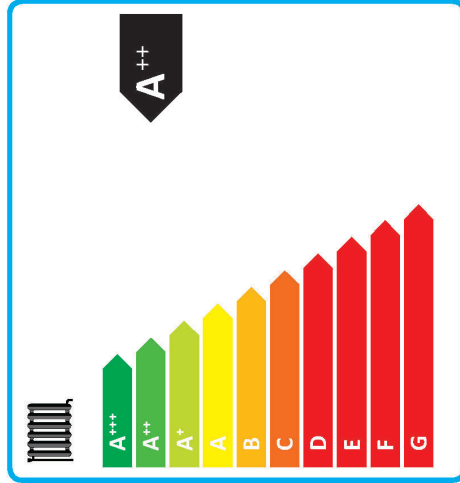
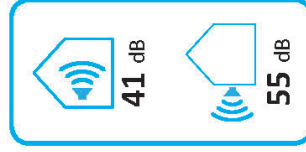
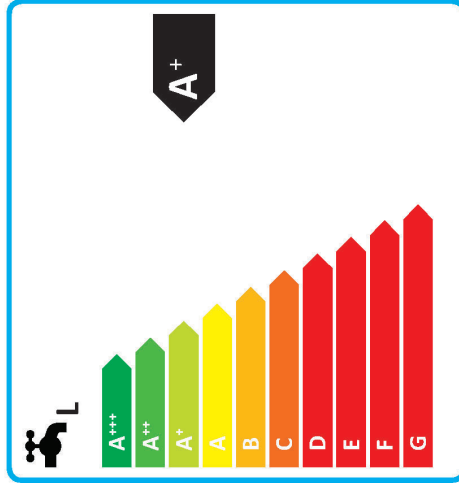
04 kW

05 kW



2019

811/2013

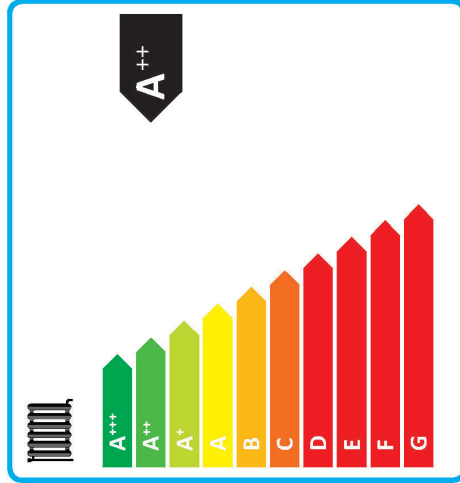
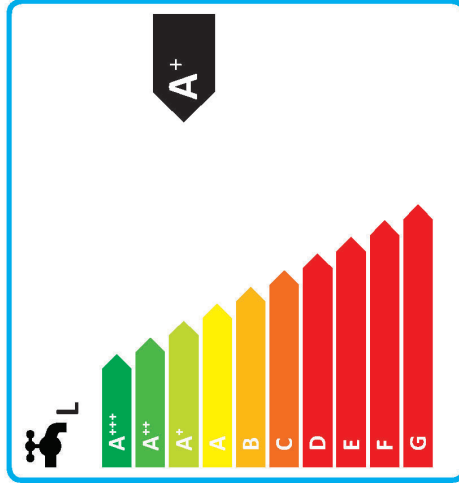
2015

811/2013



ENERG
енергия · ενεργεια

Y IJA
IE IA

Clivet S.p.A.

SQKN-YEE 1 IC + MiSAN-Y
EE 1 S 2.1

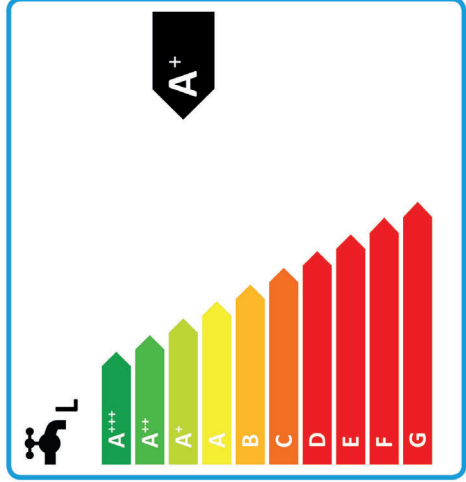
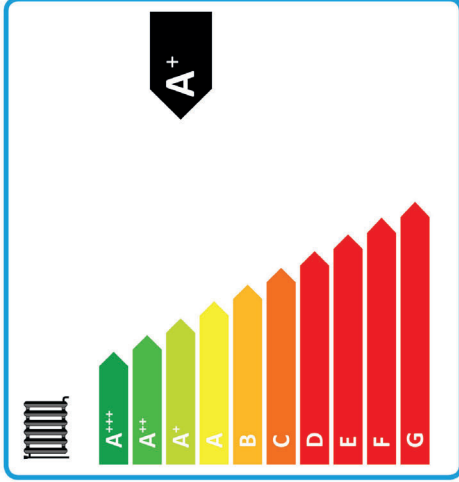

2015

811/2013



ENERG
енергия · ενεργεια

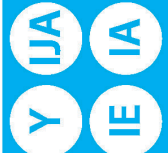

SQKN-YEE 1 IC + M1SAN-Y
EE 1 S 3.1

Clivet S.p.A.

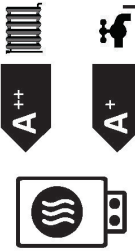

A++



A+



2015

811/2013



ENERG
енергия · ενεργεια



SQKN-YEE 1 IC + M1SAN
-YEE 1 S 3.1

Clivet S.p.A.



A++



A+

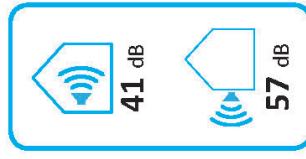

2019

811/2013



ENERG
енергия · ενεργεια



Clivet S.p.A.

SQKN-YEE 1 IC + MISAN-Y
EE 1 S 3.1

Icons for energy efficiency and environmental impact:

- Energy efficiency: A++ (with radiator icon), A+ (with tap icon)
- Environmental impact: A++ (with radiator icon), A+ (with tap icon)

Icons for energy efficiency and environmental impact:

- Energy efficiency: A++ (with radiator icon), A+ (with tap icon)
- Environmental impact: A++ (with radiator icon), A+ (with tap icon)

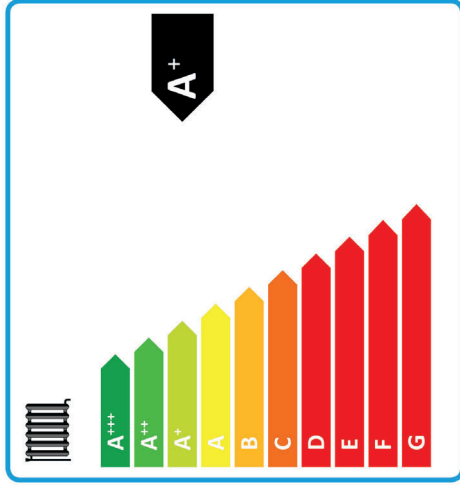

2015

811/2013















ENERG
енергия · ενεργεια

Y IJA
IE IA

SQKN-YEE 1 IC + MISAN-Y
EE 1 S 4.1

Clivet S.p.A.

			
<input checked="" type="checkbox"/>	<input checked="" type="checkbox"/>	<input checked="" type="checkbox"/>	<input checked="" type="checkbox"/>

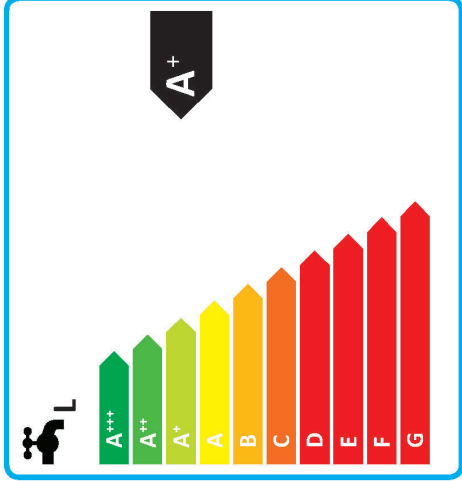
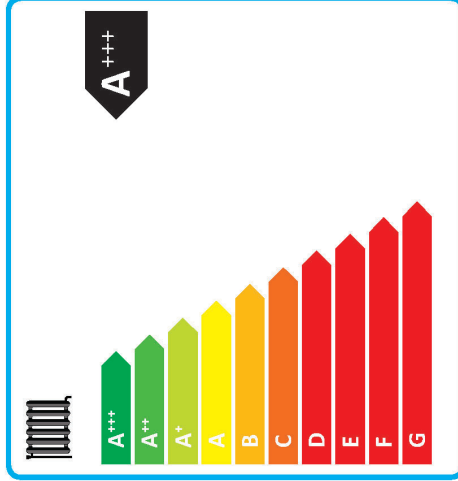

2015

811/2013





ENERG
енергия · ενεργεια

Y IJA
IE IA

SQKN-YEE 1 IC + MISAN
-YEE 1 S 4.1

Clivet S.p.A.



	41 dB		58 dB
---	-------	---	-------

	07 kW		07 kW		09 kW
--	-------	---	-------	---	-------



2019

811/2013



















ENERG
енергия · ενεργεια

Y IJA
IE IA

Clivet S.p.A.

SQKN-YEE 1 IC + MiSAN-Y
EE 1 S 4.1





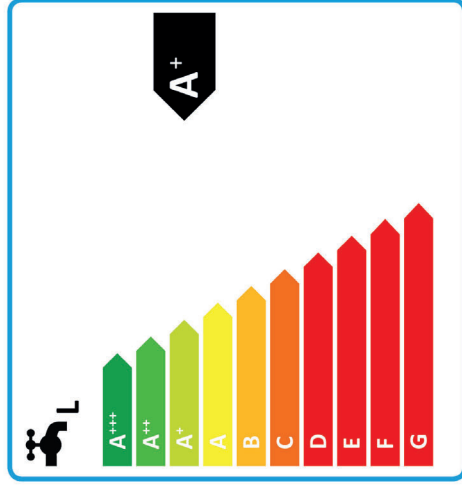
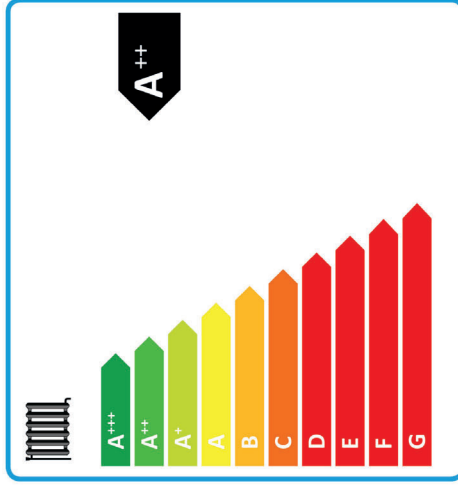











ENERG
енергия · ενεργεια

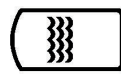

SQKN-YEE 1 IC + MİSAN-Y
EE 1 S 5.1

Clivet S.p.A.

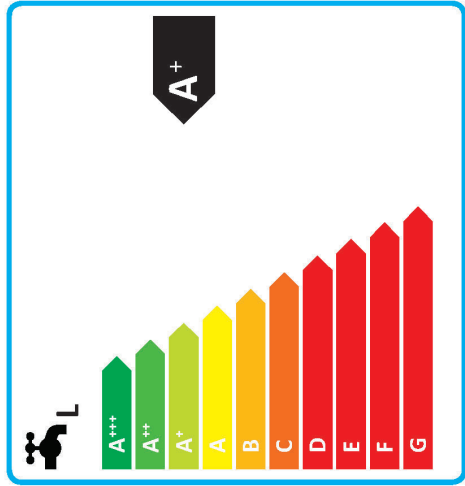
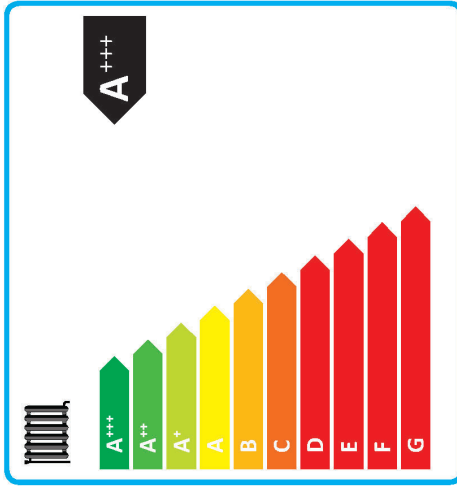

2015

811/2013



ENERG
енергия · ενεργεια



SQKN-YEE 1 IC + MİSAN
-YEE 1 S 5.1

Clivet S.p.A.



A++



A+

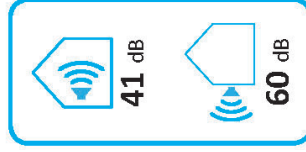

2019

811/2013

















ENERG
енергия · ενεργεια

Y IJA
IE IA

SQKN-YEE 1 IC + MiSAN-Y
EE 1 S 5.1

Clivet S.p.A.

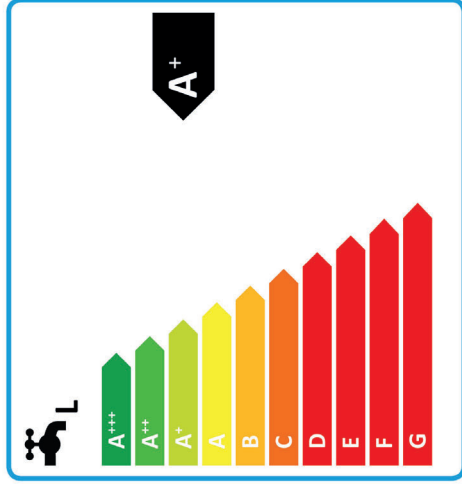
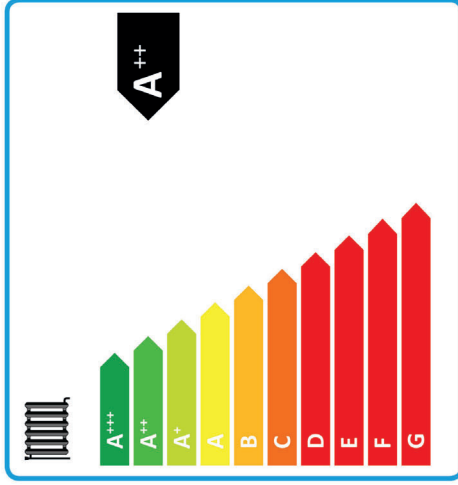

WE DECLARE UNDER OUR SOLE RESPONSIBILITY THAT THE MACHINE

DICHIARIAMO SOTTO LA NOSTRA SOLA RESPONSABILITÀ CHE LA MACCHINA
 WIR ERKLÄREN EIGENVERANTWORTLICH, DASS DIE MASCHINE
 NOUS DÉCLARONS SOUS NOTRE SEULE RESPONSABILITÉ QUE LA MACHINE
 EL FABRICANTE DECLARA BAJO SU EXCLUSIVA RESPONSABILIDAD QUE LA MÁQUINA

CATEGORY	CONDENSING UNITS - Heat pump
CATEGORIA	MOTOCONDENSANTI - Pompa di calore
KATEGORIE	VERFLÜSSIGUNGSEINHEITEN - Wärmepumpe
CATEGORIE	GROUPES DE CONDENSATION - Pompe à chaleur
CATEGORIA	MOTOCONDENSADORAS - Bomba de calor

TYPE / TIPO / TYP / TYPE / TIPO

MODEL
MISAN-YEE 1 S 2.1
MISAN-YEE 1 S 3.1
MISAN-YEE 1 S 4.1
MISAN-YEE 1 S 5.1

- **COMPLIES WITH THE FOLLOWING EEC DIRECTIVES, INCLUDING THE MOST RECENT AMENDMENTS, AND THE RELEVANT NATIONAL HARMONISATION LEGISLATION CURRENTLY IN FORCE:**
 - RISULTA IN CONFORMITÀ CON QUANTO PREVISTO DALLE SEGUENTI DIRETTIVE CEE, COMPRESI LE ULTIME MODIFICHE, E CON LA RELATIVA LEGISLAZIONE NAZIONALE DI RECEPIMENTO:
 - DEN IN DEN FOLGENDEN EWG-RICHTLINIEN VORGESEHENEN VORSCHRIFTEN, EINSCHLIEßLICH DER LETZTEN ÄNDERUNGEN, SOWIE DEN ANGEWANDTEN LANDESGESETZEN ENTSPRICHT:
 - EST CONFORME AUX DIRECTIVES CEE SUIVANTES, Y COMPRIS LES DERNIÈRES MODIFICATIONS, ET À LA LÉGISLATION NATIONALE D'ACCUEIL CORRESPONDANTE:
 - ES CONFORME A LAS SIGUIENTES DIRECTIVAS CEE, INCLUIDAS LAS ÚLTIMAS MODIFICACIONES, Y A LA RELATIVA LEGISLACIÓN NACIONAL DE RECEPCIÓN:
- 2014/35/EC** **low voltage directive** / direttiva bassa tensione
Bestimmungen der Niederspannungsrichtlinie / directive basse tension
directiva de baja tensión
 - 2014/30/UE** **electromagnetic compatibility** / compatibilità elettromagnetica
Elektromagnetische Verträglichkeit / compatibilité électromagnétique / compatibilidad electromagnética
 - 2009/125/CE** **Ecodesign** / Progettazione ecocompatibile / Ecodesign / Éco-conception / Ecodiseño
 - 2011/65/UE** **2015/863/UE** **RoHs**

-Unit manufactured and tested according to the followings Standards:	EN 55014-1 :2017 EN 55014-2 :2015 EN 61000-3-2 :2014
-Unità costruita e collaudata in conformità alle seguenti Normative:	EN 61000-3-3 :2013 EN 62233 :2008
-Unité construite et testée en conformité avec les Réglementations suivantes	EN 60335-2-40 :2003+A11 :2004+A12 :2005+A1 :2006+A2 :2009+A13 :2012
-Unidad construida y probada de acuerdo con las siguientes Normativas	EN 60335-1 :2012+A11 :2014+A13 :2017+A1 :2019+A14 :2019
-Gebautes und geprüftes Gerät nach folgenden Normen	EN62321-1 :2013 EN 62321-2 :2014 EN 62321-3-1 :2014 EN 62321-4 :2014
	EN 62321-5 :2014 EN 62321-6 :2015 EN 62321-7-1 :2015
	EN 62321-7-2 :2017 EN 62321-8 :2017 EN 378-2

-Responsible to constitute the technical file is the company n°.00708410253 and registered at the Chamber of Commerce of Belluno Italy
 -Responsabile a costituire il fascicolo tecnico è la società n°.00708410253 registrata presso la Camera di Commercio di Belluno Italia
 -Verantwortliche für die technischen Unterlagen zusammenstellen n°.00708410253 ist das Unternehmen bei der Handelskammer von Belluno Italien registriert
 -Responsable pour compiler le dossier technique est la société n°00708410253 enregistrée à la Chambre de Commerce de Belluno en Italie
 -Encargado de elaborar el expediente técnico es la empresa n°00708410253 registrada en la Cámara de Comercio de Belluno Italia

FELTRE, 26/03/2021

NAME / NOME / VORNAME / PRÉNOM / NOMBRE
 SURNAME / COGNOME / ZUNAME / NOM / APELLIDOS
 COMPANY POSITION / POSIZIONE / BETRIEBSPOSITION / FONCTION / CARGO **STEFANO BELLO** LEGALE RAPPRESENTANTE

NOTE

FOR OVER 30 YEARS, WE HAVE BEEN OFFERING SOLUTIONS TO ENSURE SUSTAINABLE COMFORT AND THE WELL-BEING OF PEOPLE AND THE ENVIRONMENT



Sales and assistance

www.clivet.com

MideaGroup
humanizing technology



CLIVET S.p.A.

Via Camp Lonc 25, Z.I. Villapaiera
32032 Feltre (BL) - Italy
Tel. +39 0439 3131 - info@clivet.it

CLIVET GMBH

Hummelsbütteler Steindamm 84,
22851 Norderstedt, Germany
Tel. +49 40 325957-0 - info.de@clivet.com

Clivet Group UK LTD

Units F5 & F6 Railway Triangle,
Portsmouth, Hampshire PO6 1TG
Tel. +44 02392 381235 -
Enquiries@Clivetgroup.co.uk

CLIVET LLC

Office 5 08-511, Elektro zavodskaya st. 24,
Moscow, Russian Federation, 107023
Tel. +7495 6462009 - info.ru@clivet.com

CLIVET MIDEAST FZCO

Dubai Silicon Oasis (DSO), High Bay Complex,
Office N. 20, PO BOX 342009, Dubai, UAE
Tel. +971 (0) 45015840 - info@clivet.ae

Clivet South East Europe

Jarušćica 9b
10000, Zagreb, Croatia
Tel. +385 916065691 - info.see@clivet.com

Clivet Airconditioning Systems Pvt Ltd

Office No.5 01 & 5 02, 5th Floor, Commercial -I,
Kohinoor City, Old Premier Compound, Off LBS
Marg, Kiroi Road, Kurla West, Mumbai
Maharashtra 400070, India
Tel. +91 22 30930200 - sales.india@clivet.com